



210-FE

**WEIGHT INDICATING INSTRUMENT
INSTALLATION and TECHNICAL MANUAL**

8200-M242-O1 Rev B
04/08

203 E. Daugherty, Webb City, MO 64870 USA
Ph: 417-673-4631 • Fax: 417-673-2153
www.cardinalscales.com



Printed in USA

Technical Support: Ph: 866-254-8261 • tech@cardet.com

TABLE OF CONTENTS

SPECIFICATIONS -----Page 1
 Standard Features -----Page 2
 Optional Features -----Page 2
 Certifications -----Page 2
 EUROPEAN DECLARATION OF CONFORMITY -----Page 3
 PRECAUTIONS -----Page 4
 SITE PREPARATION REQUIREMENTS -----Page 5
 INSTALLATION -----Page 6
 Mounting -----Page 6
 Load Cell Cable Connection For RFI Suppression -----Page 7
 Load Cell Cable Connection (*Standard Gland Connection*) -----Page 8
 Load Cell Connections With Over 30 Feet Of Cable -----Page 9
 Serial I/O Cable Installation -----Page 9
 Optically Isolated Inputs -----Page 10
 Optically Isolated Outputs -----Page 10
 Relay Board (*Optional*) -----Page 11
 Main PCB (*Figure No. 9*) -----Page 12
 Main PCB Jumpers -----Page 13
 Re-Installing The Rear Panel -----Page 13
 KEYPAD FUNCTIONS -----Page 14
 DISPLAY BRIGHTNESS -----Page 18
 ANNUNCIATOR DISPLAY -----Page 19
 SETUP AND CALIBRATION -----Page 21
 SETUP REVIEW -----Page 39
 CALIBRATION "C" NUMBERS -----Page 40
 ACCUMULATORS -----Page 40
 TROUBLESHOOTING -----Page 41
 Error Codes -----Page 41
 Before You Call Service -----Page 43
 CALIBRATION SEAL INSTALLATION -----Page 44
 AXLE WEIGHER OPERATION MODE -----Page 45
 PARTS IDENTIFICATION -----Page 47

SERIAL NUMBER _____ DATE OF PURCHASE _____ PURCHASED FROM _____ _____ _____ _____ _____ _____ _____ RETAIN THIS INFORMATION FOR FUTURE USE

PRECAUTIONS

Before using this instrument, read this manual and pay special attention to all "WARNING" symbols:



IMPORTANT



**ELECTRICAL
WARNING**



**STATIC
SENSITIVE**

FCC COMPLIANCE STATEMENT

This equipment generates uses and can radiate radio frequency and if not installed and used in accordance with the instruction manual, may cause interference to radio communications. It has been tested and found to comply with the limits for a Class A computing device pursuant to Subpart J of Part 15 of FCC rules, which are designed to provide reasonable protection against such interference when operated in a commercial environment. Operation of this equipment in a residential area may cause interference in which case the user will be responsible to take whatever measures necessary to correct the interference.

You may find the booklet "How to Identify and Resolve Radio TV Interference Problems" prepared by the Federal Communications Commission helpful. It is available from the U.S. Government Printing Office, Washington, D.C. 20402, stock No. 001-000-00315-4.

PROPER DISPOSAL

When this device reaches the end of its useful life, it must be properly disposed of. It must not be disposed of as unsorted municipal waste. Within the European Union, this device should be returned to the distributor from where it was purchased for proper disposal. This is in accordance with EU Directive 2002/96/EC. Within North America, the device should be disposed of in accordance with the local laws regarding the disposal of waste electrical and electronic equipment.

It is everyone's responsibility to help maintain the environment and to reduce the effects of hazardous substances contained in electrical and electronic equipment on human health. Please do your part by making certain that this device is properly disposed of. The symbol shown below indicates that this device must not be disposed of in unsorted municipal waste programs.



All rights reserved. Reproduction or use, without expressed written permission, of editorial or pictorial content, in any manner, is prohibited. No patent liability is assumed with respect to the use of the information contained herein.

While every precaution has been taken in the preparation of this manual, the Seller assumes no responsibility for errors or omissions. Neither is any liability assumed for damages resulting from use of the information contained herein. All instructions and diagrams have been checked for accuracy and ease of application; however, success and safety in working with tools depend to a great extent upon the individual accuracy, skill and caution. For this reason the Seller is not able to guarantee the result of any procedure contained herein. Nor can they assume responsibility for any damage to property or injury to persons occasioned from the procedures. Persons engaging the procedures do so entirely at their own risk.

SPECIFICATIONS

Power Requirements:	90 to 264 VAC (50/60 Hz) at 0.4A
Enclosure Type:	NEMA 4X/IP66
Enclosure Size:	9.7" H x 15" W x 3.1" D (246mm H x 381mm W x 79mm D)
Shipping Weight:	12 lbs / 5.4 kg
Operating Environment:	Temperature: 14 to 104 °F (-10 to +40 °C) Humidity: 90% non-condensing (maximum)
Display:	Six digit, seven segment, 2.5" high (display) Three digit, sixteen segment, 0.8" high (annunciators) Ten level brightness control
Transducer Excitation:	12 VDC
Signal Input Range:	1.0 mV min. to 40 mV max. (with dead load boost)
Number of Load Cells:	8 each, 350 OHM minimum resistance
Load Cell Cable Length:	1500 feet maximum. Consult factory for other requirements 30 feet maximum without sense lines
Division Value:	1, 2, or 5 x 10, 1, 0.1, 0.01, 0.001 commercial 0 to 99, non-commercial
Sensitivity:	
NON-COMMERCIAL	0.15 uV/e
NTEP	0.3uV/e (Class III/IIIL)
CANADA	0.3uV/e (Class III/IIHHD)
OIML	0.7 uV/e (Class III)
Scale Divisions:	
NON-COMMERCIAL	100 to 240,000
NTEP	100 to 10,000 (Class III/IIIL)
CANADA	100 to 10,000 (Class III/IIHHD)
OIML	100 to 10,000 (Class III)
Internal Resolution:	1 part in 16,777,216
Tare Capacity:	Scale Capacity
Sample Rate:	1 to 100 samples per second, selectable
Auto Zero Range:	0.5 or 1 through 9 divisions
Weighing Units:	Tons, Pounds, Ounces, Metric Tons, Kilograms, Grams
Keypad:	Color coded Membrane type, 22 keys
Standard I/O:	(1) bi-directional RS232 (20mA) (1) output only RS232 (20mA)

SPECIFICATIONS, Cont.

Standard Features:

- Push button tare function
- Gross, tare, net conversion
- Selectable key lockout
- Hi-Resolution mode
- Adjustable filtering
- Gross and Net accumulators
- Dual serial ports
- Remote input lines for Zero, Tare, Gross and Print (1000 feet maximum)
- Programmable print format using Visual Print or nControl (2 Visual Tickets available)
- SMA level 2 compliant serial communications
(For more information see <http://www.scalemanufacturers.org>)
- Field re-programmable via PC interconnection
- Test feature (performs display and internal tests)
- Auto Shutoff and Sleep modes
- Numeric keypad
- Keypad tare function
- Count feature with accumulator
- Time and Date with selectable 12 or 24 hour operation
- Checkweigher
- Three Preset Weight Comparators
- Axle Weigher (CWL-40) Operation Mode

Optional Features:

Analog Output*, Allen-Bradley Interface*, 10/100 mbps Ethernet Adapter*, Additional Serial Port*, Checkweigher Light Bar*, Internal Relay Box*, External Relay Box* and Special Filtering

*This feature requires additional hardware and includes additional documentation.

Certifications:

This equipment is certified to comply with the requirements for a Class III/IIIL device by the

- National Conference on Weights and Measurements (Certificate No. 01-011)
- Measurement Canada (Approval No. AM-5397)
- And for a Class III device by OIML R-76 (Certificate No. DK 0199.47).



EUROPEAN DECLARATION OF CONFORMITY

Manufacturer: Cardinal Scale Manufacturing Company

PO Box 151
203 East Daugherty
Webb City, Missouri 64870 USA

Telephone No. 417 673 4631
Fax No. 417 673 5001

Product: Non-automatic Weight Indicating Instrument
Model Numbers 200, 205, 210, 210-FE, 215 and 220
Serial Number EXXXYY-ZZZ
where XXX = day of year
YY = last two digits of year
ZZZ = sequential number

The undersigned hereby declares, on behalf of Cardinal Scale Manufacturing Company of Webb City, Missouri, that the above-referenced product, to which this declaration relates, is in conformity with the provisions of:

European Standard EN 45501: 1992 and equivalent International Recommendation OIML R76, edition 1992
EU Type Approval Certificate Number DK 0199.47
Report No. DANAK-195612

Council Directive 2006/95/EC Low Voltage Directive

Council Directive 90/384/EEC (20 June, 1990) on the Harmonization Of the Laws of Member States relating to non-automatic weighing Systems as amended by:
Council Directive 93/68/EEC (22 July, 1993)
Report No. DANAK-195728

European Standard EN50082: 1995 for radiated emissions and
European Standard EN50082-2: 1995 Class B for EMC immunity.

The Technical Construction File required by this Directive is maintained at the corporate headquarters of Cardinal Scale Manufacturing Company, 203 East Daugherty, Webb City, Missouri.



Ginger Harper
Quality Assurance Manager

PRECAUTIONS

Static Electricity



CAUTION! This device contains static sensitive circuit cards and components. Improper handling of these devices or printed circuit cards can result in damage to or destruction of the component or card. Such actual and/or consequential damage **IS NOT** covered under warranty and is the responsibility of the device owner. Electronic components must be handled only by qualified electronic technicians who follow the guidelines listed below.



ATTENTION! ALWAYS use a properly grounded wrist strap when handling, removing or installing electronic circuit cards or components. Make certain that the wrist strap ground lead is securely attached to an adequate ground. If you are uncertain of the quality of the ground, you should consult a licensed electrician.



ALWAYS handle printed circuit card assemblies by the outermost edges. **NEVER** touch the components, component leads or connectors. **ALWAYS** observe warning labels on static protective bags and packaging and never remove the card or component from the packaging until ready for use. **ALWAYS** store and transport electronic printed circuit cards and components in anti-static protective bags or packaging.

Environmental

The Cardinal 210-FE indicator meets or exceeds all certification requirements within a temperature range of 14 to 104 °F (-10 to +40 °C).

In order to keep cooling requirements to a minimum, the indicator should be placed out of direct sunlight and to provide adequate air circulation, keep the area around the indicator clear.

Make certain the instrument is not directly in front of a heating or cooling vent. Such a location will subject the indicator to sudden temperature changes, which may result in unstable weight readings.

Insure that the indicator has good, clean AC power and is properly grounded.

In areas subject to lightning strikes, additional protection to minimize lightning damage, such as surge suppressors, should be installed.

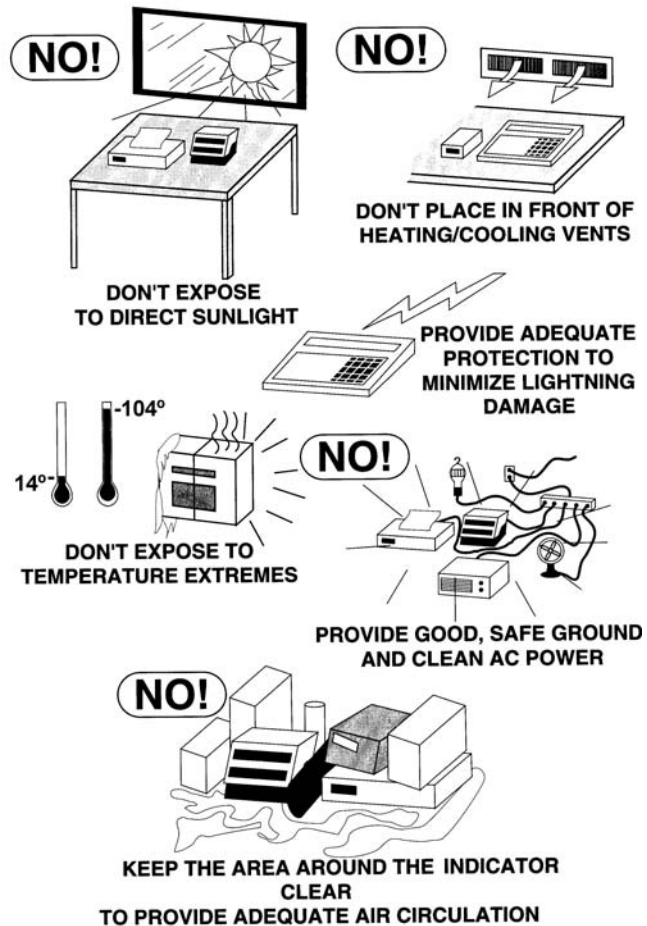

PRECAUTIONS, Cont.

Care and Cleaning

1. **DO NOT** submerge the indicator in water, pour or spray water directly on it.
2. **DO NOT** use acetone, thinner or other volatile solvents for cleaning.
3. **DO NOT** expose the indicator to temperature extremes.
4. **DO NOT** place the indicator in front of heating/cooling vents.
5. **DO** clean the indicator with a damp soft cloth and mild non-abrasive detergent.
6. **DO** remove power before cleaning with a damp cloth.

SITE PREPARATION REQUIREMENTS

The Cardinal 210-FE indicator is a precision weight-measuring instrument. As with any precision instrument, it requires an acceptable environment to operate at peak performance and reliability. This section is provided to assist you in obtaining such an environment.

Electrical Power

The 210-FE indicator has been designed to operate from 90 to 264 VAC at 50/60 Hz. Note that a special order is not required for operation at 230 VAC.



CAUTION! - To avoid electrical hazard and possible damage to the indicator, **DO NOT**, under any circumstance, cut, remove, alter, or in any way bypass the power cord grounding prong.

On models requiring 230 VAC power, **it is the responsibility of the customer** to have a qualified electrician install the proper power cord plug which conforms to national electrical codes and local codes and ordinances.

The power outlet for the indicator should be on a separate circuit from the distribution panel. This circuit should be dedicated to the exclusive use of the indicator. The wiring should conform to national and local electrical codes and ordinances and should be approved by the local inspector to assure compliance.

To prevent electrical noise interference, make certain all other wall outlets for use with air conditioning and heating equipment, lighting or other equipment with heavily inductive loads, such as welders, motors and solenoids are on circuits separate from the indicator. Many of these disturbances originate within the building itself and can seriously affect the operation of the instrument. These sources of disturbances must be identified and steps must be taken to prevent possible adverse effects on the instrument. Examples of available alternatives include isolation transformers, power regulators, uninterruptible power supplies, or simple line filters.



CAUTION! When in parallel runs, locate Load Cell cables a minimum of 24" away from all AC wiring.

INSTALLATION

Before beginning installation of your 210-FE Weight Indicating Instrument, make certain that the instrument has been received in good condition. Carefully remove the instrument from the shipping carton and inspect it for any evidence of damage (such as exterior dents or scratches) that may have taken place during shipment. Keep the carton and packing material for return shipment if it should become necessary. It is the responsibility of the purchaser to file all claims for any damages or loss incurred during transit.

Mounting

The Model 210-FE indicator is housed in a NEMA 4X/IP66 stainless steel wall or desk-mount enclosure. The gimbal may be mounted on a desktop or other smooth, flat, horizontal surface or may be mounted on a wall. Refer to Figure No. 1 for a layout of wall-mounting bolts.

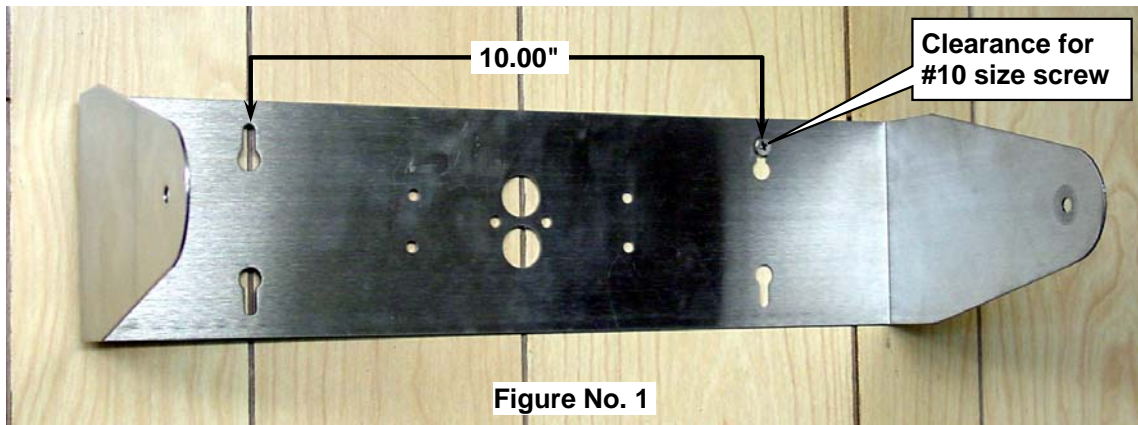

If wall mounted, make certain the mounting surface is strong enough to support the indicator. The mounting location should be where the display is easily viewed while being close enough to provide the operator easy access to the keypad. Carefully lay out the mounting hole locations, then drill and install the anchor bolts. Attach the gimbal to the wall and securely tighten the retaining bolts.

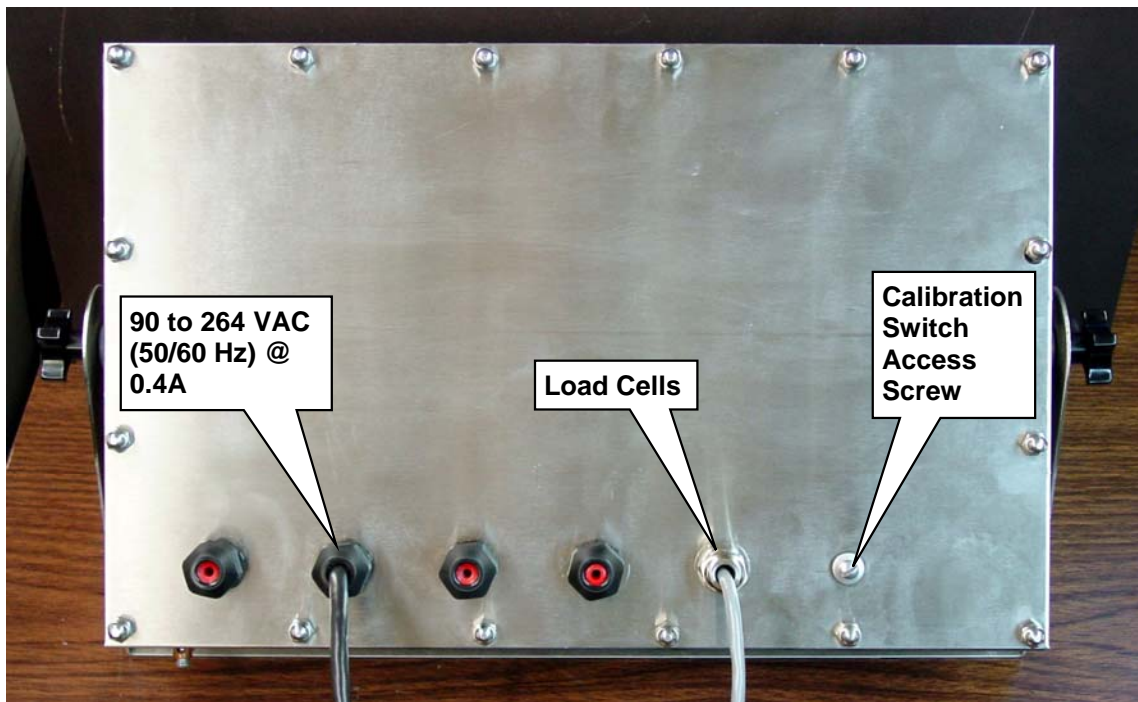

INSTALLATION, Cont.

Load Cell Cable Connection for RFI Suppression



CAUTION! Disconnect any external load cell power supply before connecting load cells to the instrument. Failure to do so will result in permanent damage to the instrument.

To eliminate RFI, the load cell cable should be routed through the special metallic gland connector and the shield wire from the load cell cable must be connected to this gland connector for grounding. Refer to Figure No. 2 for the gland connector layout.

1. Remove the 16 acorn nuts securing the rear panel to the main housing.
2. Loosen and remove the metal gland connector nut and remove the plastic insert.
3. Referring to Figure No. 3, route the single cable from the load cell or load cell junction box through the nut and plastic insert and into the enclosure.
4. With the load cell cable routed into the enclosure, refer to Figure No. 4 and then remove approximately 5 to 6 inches of the outer insulating jacket from the cable exposing the internal wires.
5. Next, cut the shield wire so that it extends past the outer jacket about 3/4 inch.
6. Now, remove 1/4 inch of insulation from the end of each of the 4 wires (without sense leads) or 6 wires with sense leads.



Figure No. 3

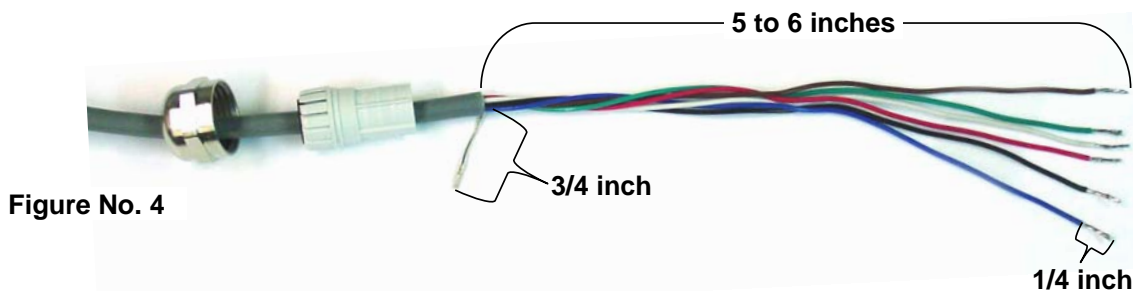

Figure No. 4

7. Referring to the table below (or on the circuit board) for terminal connections, connect each of the wires to terminal block P1. Refer to Figure No. 9 for terminal block location.

LOAD CELL CONNECTOR P1

<u>PIN NO.</u>	<u>Function</u>	<u>PIN NO.</u>	<u>Function</u>
1	+ EXCITATION	5	- SIGNAL
2	+ SENSE	6	- SENSE
3	+ SIGNAL	7	- EXCITATION
4	SHEILD		

INSTALLATION, Cont.

- To terminate a wire, use a small flat blade screwdriver and press down on the release bar for the terminal. Insert the wire into the terminal opening. Remove the screwdriver, allowing the release bar to return to its original position, locking the wire in place. See Figure No. 5.
- Repeat the procedure until all of the wires are in place.
- After all terminations have been made, remove the excess cable from the enclosure.

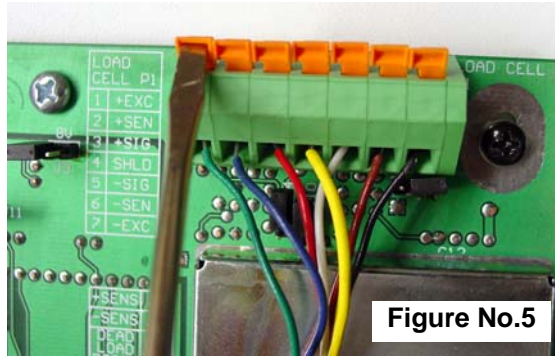

Figure No.5

- Referring to Figure No. 6, fold the shield wire back over the plastic insert and then insert the plastic insert (with the shield wire) into the gland connector.
- The shield wire is secured when tightening the gland connector nut. See Figure No. 7.
- Do not over-tighten the connector but make certain it is snug.

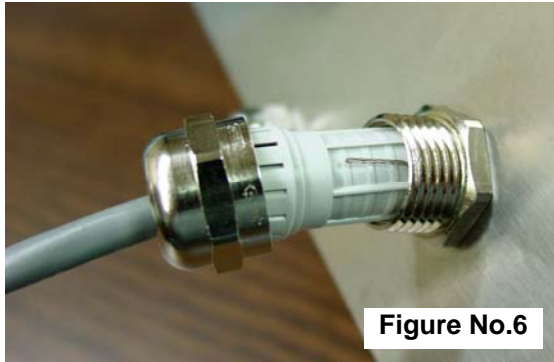

Figure No.6

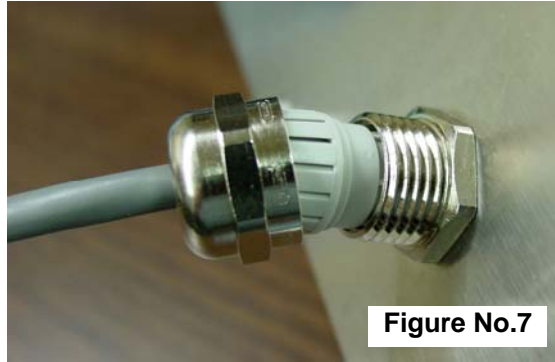

Figure No.7

Load Cell Cable Connection (Standard Gland Connector)

The following instructions describe the load cell connection should it be desired to route the load cell cable through a standard gland connector.

- Remove the 16 acorn nuts securing the rear panel to the main housing.
- Referring to Figure No. 2, choose a gland connector for the cable and then loosen it.
- Slip the single cable from the load cell or load cell junction box through the gland connector and into the enclosure.
- Referring to Figure No. 4, remove 3 inches (not 5 to 6 inches) of the outer insulation jacket
- Next, remove 1/4 inch of insulation from each of the 4 wires and shield (without sense leads) or 6 wires and shield (with sense leads).
- Referring to the table on the previous page (or on the circuit board) for terminal connections, connect each of the wires to terminal block P7. Refer to Figure No. 9 for terminal block location.
- To terminate a wire, use a small flat blade screwdriver and press down on the release bar for the terminal. Insert the wire into the terminal opening. Remove the screwdriver, allowing the release bar to return to its original position, locking the wire in place.
- Repeat procedure until all of wires are in place.
- If a standard gland connector is used, the shield wire should be connected to terminal 4 of the P1 terminal block connector.

INSTALLATION, Cont.

Load Cell Connections with Over 30 Feet of Cable

For installations with over 30 feet of cable between the indicator and the load cells, sense wires should be used. The sense wires must be connected between the +SENS, -SENS terminals on the indicator and the +EXCITATION, -EXCITATION wires of the load cells or the +SENS, -SENS terminals of the load cell trim board or the section seal trim board.

Serial I/O Cable Installation

The 210-FE indicator may be connected to a printer to record weight and associated data or it may be connected to a remote display or even to a computer for transmission of weight data. The weight data may be transmitted on demand (pressing the **PRINT** key or on receipt of a command from the computer). Refer to the Setup, SIO Serial I/O section of this manual.

1. If the rear panel of the indicator has been removed, proceed to step 2. Otherwise, remove the 16 acorn nuts securing the rear panel to main housing
2. Loosen the gland connector for the serial cable. Refer to Figure No. 2 for the gland connector layout.
3. Slip the serial cable through the gland connector and into the enclosure.
4. Referring to Figure No. 4, remove 2 inches (not 5 to 6 inches) of the outer insulation jacket
5. Next, remove 1/4 inch of insulation from each of the wires.
6. Connect each of the wires to the Serial I/O terminal block (P11) referring to Figure No. 9 for terminal block locations.
7. To terminate a wire, use a small flat blade screwdriver and press down on the release bar for the terminal. Insert the wire into the terminal opening. Remove the screwdriver, allowing the release bar to return to its original position, locking the wire in place. See Figure No. 5.
8. Repeat procedure until all of wires are in place.

BI-DIRECTIONAL SERIAL INTERFACE		SERIAL OUTPUT	
<u>TERMINAL NO.</u>	<u>Function</u>	<u>TERMINAL NO.</u>	<u>Function</u>
1	TXD 1 - RS232	5	TXD 2 - RS232
2	RXD 1 - RS232	6	TXD 2 – 20 mA Active
3	TXD 1 – 20 mA Active	7	GROUND
4	GROUND		

INSTALLATION, Cont.

Optically Isolated Inputs (requires additional hardware)

Included with the I/O are 4 programmable inputs that may be used to remotely (up to 100 feet) initiate various functions within the indicator. These inputs are accessed via a terminal block (P9) on the back of the PC board (see Figure No. 9). The 4 inputs are defined as follows:

<u>TERMINAL NO.</u>	<u>Function</u>
1	Gross
2	Print
3	Zero
4	Tare
5	Common

NOTE! The input must be connected to Gnd to initiate the function.

Optically Isolated Outputs (requires additional hardware)

PRESET WEIGHT COMPARATOR CHECKWEIGHER LOGIC LEVEL OUTPUT

If desired, you may use the optically isolated outputs from your Model 210-FE indicator's preset weight comparators or checkweigher to remotely (up to 100 feet) control peripheral devices used to manage the flow of material or signal when the weight is within preset limits.

J11 (12V) - ACTIVE REMOTE OUT JUMPER

The Active Remote Out jumper J11, when connected, allows the 210-FE indicator to supply (source) 12 VDC to a solid-state relay or other load of 200 ohms or greater. To operate from the 12 VDC source, the positive connection from the relays must be connected to the PWC connector pins and the negative wire from the relays to the GND pin. See Figure No. ? for jumper and REMOTE OUTPUT connector location.

For completely isolated outputs, J11 must be open (positioned on one plug-in pin only or removed) and the user must provide 12 to 24 VDC to the SRC pin and a ground return to the load. The load must still be 200 ohms or greater.

To connect the control cable to the preset weight comparator/checkweigher logic level output connector P10, first loosen the gland connector located on the right side on the back of the 210-FE. Refer to Figure No. 8 for the exact location of the connector. Slip the cable through the connector and into the enclosure. Remove 2 inches of the cable insulating jacket and then 1/4 inch of insulation from each of the internal wires (refer to Figure No. 4). Make the proper terminations on terminal block P10. To terminate a wire, first press down on the terminal block release bar, insert the wire into the terminal and remove pressure from the release bar locking the wire in place.

INSTALLATION, Cont.

Relay Board - (Optional)

The relay board (Cardinal p/n 8539-C062-0A) is mounted in the RB4-F external junction box for use with the 210-FE indicator. Connect devices to be controlled as shown in Figure No. 8.

The relays must be configured to be on (closed) or off (open) at weights under the preset weight then switch at the preset weight from on-to-off or off-to-on by setting the under weight condition to on or off during setup and calibration or setup review. Refer to the Setup and Calibration, “d out” (Digital Output) section of this manual for more information.

EXAMPLE: *d out* = 1,1

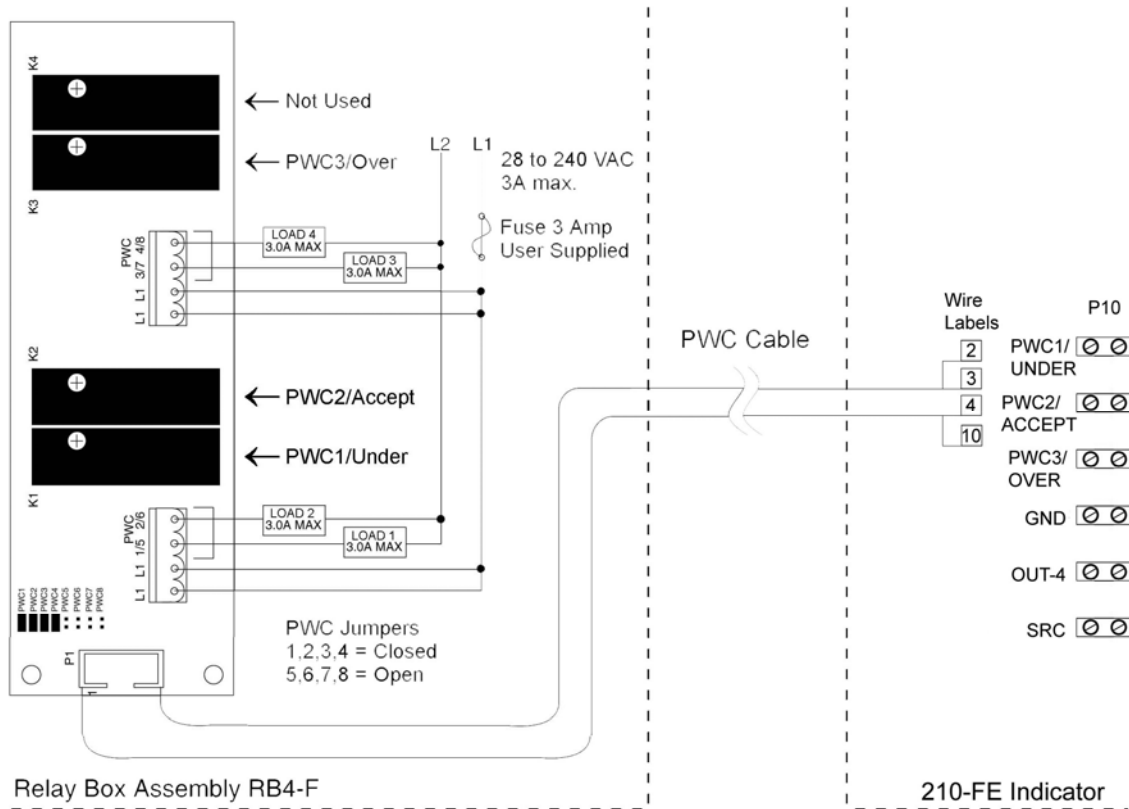

Figure No. 8

The PWC1 relay is on (closed) for weights under the preset weight and off (open) for weights equal to or over the preset weight.



NOTE! All relays are the “normally-open” type that will open when power to indicator is lost.

INSTALLATION, Cont.

Main PCB

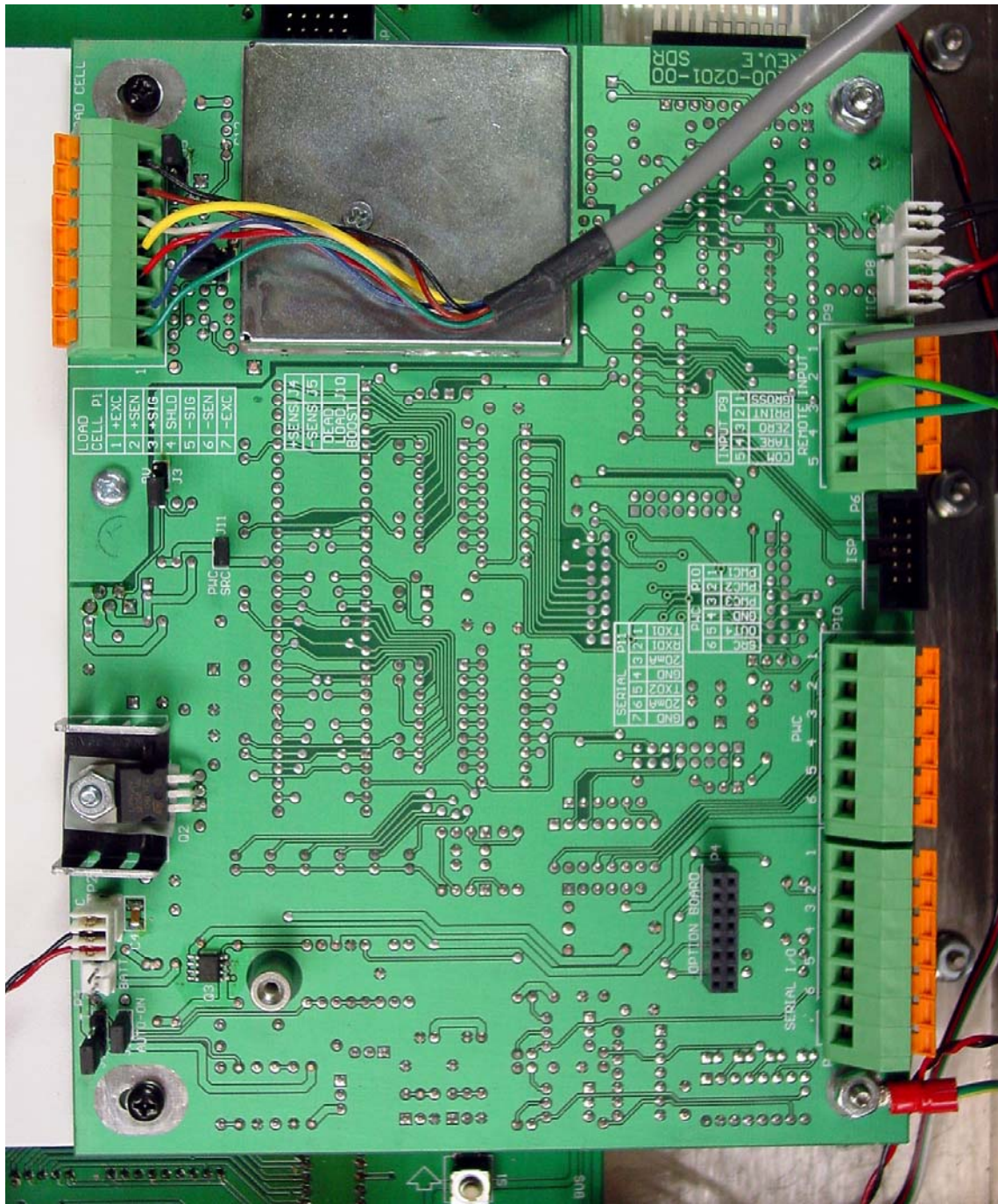

Figure No. 9

INSTALLATION, Cont.

Main PCB Jumpers

J1 - BATTERY CHARGE MODE (Not Applicable)

J2 - AUTO-ON JUMPER

The AUTO-ON jumper J2, when connected, will cause the indicator to power on automatically whenever power is applied to the power input connector. If power is lost momentarily and then reapplied, the indicator will turn on without pressing the **ON** key.

J3 - 8V EXCITATION JUMPER (Not Applicable)

J4 AND J5 - SENSE JUMPERS

If the sense leads are NOT used, you must install plug-in jumpers at J4 and J5 adjacent to the terminal block. These jumpers attach the sense leads to the excitation leads. If sense leads ARE used (as in motor truck scales), these plug-in jumpers should be positioned on one plug-in pin only or removed and stored for later use.

J10 - DEAD LOAD BOOST JUMPER

For very low dead loads (less than 10% of the combined load cell capacity) connect the dead load boost jumper J10 on the printed circuit board.

J11 – PWC SRC (SOURCE)

The J11 jumper, when connected (closed) supplies 12 VDC from the 210-FE indicator to a solid-state relay or other load of 200 ohms or greater. When J11 is open (positioned on one plug-in pin only or removed), the 12 to 24 VDC must be provided from an external source to P10-6. The load must still be 200 ohms or greater.

Re-Installing the Rear Panel

After all terminations have been made, remove the excess cable from the instrument enclosure and securely tighten each of the cable gland connectors. Do not over-tighten these connectors but make certain they are snug. **DO NOT USE TOOLS!** Finger tighten only! Insure any unused gland connectors are plugged.

1. Make certain no cables or wires are exposed between the main housing and rear panel
2. Place the rear panel onto the main housing.
3. Secure with the 16 acorn nuts removed earlier.
4. Follow a diagonal pattern when tightening the acorn nuts.

KEYPAD FUNCTIONS

The Model 210-FE is equipped with a 22-key keypad. The keypad is used to enter commands and data into the instrument. This section describes each key along with its normal function. It is helpful to refer to the actual instrument while reading this section.



DO NOT operate the keypad with pointed objects (pencils, pens, etc).
Damage to keypad resulting from this practice is **NOT** covered under warranty.



Figure No. 10

ON/OFF KEY

This key performs two functions. Pressing it when the indicator is off will apply power to the instrument. If the indicator is already on, pressing this key will turn the indicator off.

COUNT/SAMPLE KEY

This key performs two functions. The first time it is pressed, the indicator will count (unless piece weight is 0). The second time it is pressed (or if $Pc = 0$ on the first press) will show the prompt "Add = 5" on the display. Continued pressing of the **COUNT/SAMPLE** key will toggle between the Add = 5, 10, 25, 50, 75 prompts to select a sample size. When desired sample size is displayed, press the **ENTER** key **OR** with "Add = ." (5, 10 etc.) displayed, using the numeric keypad, input any desired sample value and then press the **ENTER** key. Press the * (ASTERISK) key to abort the input operation. To exit the count function and display weight, press the **NET/GROSS** key.

TIME/DATE KEY

This key is used to enter the clock mode to program the time, date and consecutive number. Pressing the **TIME/DATE** key will enter the clock mode with the 210-FE displaying Hour =.

12-Hour Format Selected In Setup (Ed = 12)

1. With the display showing Hour =, press the **ENTER** key.
2. If the time displayed is correct, press the **ENTER** key and proceed to step 4.
3. If the displayed time is incorrect, use the numeric keys to enter the correct time and press the **ENTER** key.
4. The display will change to H =. Press the **ENTER** key.
5. The display will show YES.
 - If the time is before noon (12:00 PM), press the **ENTER** key.
 - If the time is after noon (12:00 PM), press the **0/NO** key, then press the **ENTER** key.
6. The display will show DATE =. Press the **ENTER** key.

KEYPAD FUNCTIONS, Cont.

7. If the date displayed is correct, press the **ENTER** key to proceed to the consecutive number prompt, [n]_ []_ n .
8. If the date displayed is incorrect, use the numeric keys to enter the correct date and press the **ENTER** key to proceed to the consecutive number prompt. Remember to enter the date in the same format (month-day-year or day-month-year) as selected by the *USA* setup parameter. Note that with the *USA:YEE* setting, the date format is month-day-year.

24-Hour Format Selected In Setup (*td=24*)

1. With the display showing *Hour*, press the **ENTER** key.
2. If the time displayed is correct, press the **ENTER** key and proceed to step 4.
3. If the displayed time is incorrect, use the numeric keys to enter the correct time and press the **ENTER** key. Note that with the 24-hour format selected, entering all times after noon (12:00 PM), you must add 12 to the time, i.e. 3 PM would be 1500.
4. The display will show *date*. Press the **ENTER** key.
5. If the date displayed is correct, press the **ENTER** key to proceed to the consecutive number prompt, [n]_ []_ n .
6. If the date displayed is incorrect, use the numeric keys to enter the correct date and press the **ENTER** key to proceed to the consecutive number prompt. Remember to enter the date in the same format (month-day-year or day-month-year) as selected by the *USA* setup parameter. Note that with the *USA:YEE* setting, the date format is month-day-year.

Consecutive Number

If the consecutive number displayed is correct, press the **ENTER** key to resume normal operation. If the number displayed is incorrect, use the numeric keys to enter the correct consecutive number (up to 6 digits) and press the **ENTER** key to resume normal operation.

PRESET KEY

This key is used to enter the weight values for the three preset weight comparators or for the checkweigher feature depending on which feature was selected (setup parameter *dout*) during setup and calibration.

Preset Weight Comparator

If the Preset Weight Comparator feature was selected, the PWC1 annunciator will flash and the display will show the currently stored value for the number 1 preset weight comparator. If the value displayed is acceptable, press the **ENTER** key, otherwise, use the numeric keys to enter the new preset value and press the **ENTER** key. The PWC2 annunciator will now flash and the display will show the currently stored value for the number 2 preset weight comparator. As before, if the value displayed is acceptable, press the **ENTER** key, otherwise, use the numeric keys to enter the new value and press the **ENTER** key. The PWC3 annunciator will now flash and the display will show the currently stored value for the number 3 preset weight comparator. Again, if value displayed is acceptable, press the **ENTER** key, otherwise, use numeric keys to enter a new value and press the **ENTER** key.

Checkweigher (Requires 2XX-OU, Checkweigher Light Bar Option)

If the Checkweigher feature was selected and the **PRESET** key pressed, the ACCEPT and UNDER annunciators will flash and the preset value for the minimum acceptable weight will be displayed. Press the **ENTER** key if the displayed value is correct or use the numeric keys and enter the new value and press the **ENTER** key. The ACCEPT and OVER annunciators will now flash and the display will show the minimum value of weight over the accepted range. As before, if the value shown is correct, press the **ENTER** key. If the value is incorrect, enter the new value and press the **ENTER** key to save it. Note that this value must be greater than the accept value. Remember that both the preset weight comparators and checkweigher functions operate on the absolute value of weight ignoring the polarity. After the second preset value is entered, the indicator will return to normal operation.

KEYPAD FUNCTIONS, Cont.

PRINT KEY

Pressing this key will add the displayed gross or net weight or piece count to the associated accumulator and initiate the transmission of weight and other data selected during setup of the Print menu items via the selected printer output port (see Port= under Print menu) unless the continuous data feature of this port was enabled during setup and calibration.

If the **ID=** (ID Prompt) has been enabled during setup, when the **PRINT** key is pressed, the indicator will prompt for an ID to be printed on the ticket.

```
#2
10:19 23/08/2000
100.00 lb G
20.00 lb T
80.00 lb N
      0.00 lb GROSS ACCUM
272.00 lb NET ACCUM
```

TICKET EXAMPLE

If the **RECALL** is set to 1 (Yes), input up to 6 digits for the ID and then press the **ENTER** key to complete the transaction. The print function will occur after the **ENTER** key is pressed.

If the **RECALL** is set to 0 (no), press the **ENTER** key to display the current ID. If ID displayed is acceptable, press the **ENTER** key again to complete transaction. Otherwise, input up to 6 digits for the ID and then press the **ENTER** key to complete the transaction. The print function will occur after the **ENTER** key is pressed.



NOTE! The indicator will not respond to the Print command unless the weight display is stable. If displaying gross weight, the only weight printed is gross weight. If displaying net weight, the gross, tare, and net weights are printed.

Programmable Print Formats

The 210-FE includes support for 2 programmable print formatted tickets in addition to the standard print tab settings. These tickets are designed by the Cardinal Scale's PC based programs Visual Print or nControl and then downloaded to the indicator.

During operation, the print formats are selected by using the **⊖** and **PRINT** keys in combination (refer to the next section for details). **NOTE!** When the **PRINT** key is pressed, the indicator looks for the selected format. If the selected format is not found, the print tab settings will be used to print the ticket.

ZERO/REVIEW KEY

This key performs two functions. In normal operation, pressing this key will cause an immediate zeroing of the weight display up to the selected limit of 4% or 100% of the scale's capacity. Note that this selection is made during the setup and calibration of the instrument. Pressing this key after the **⊖** key will enter the Review mode of Setup and Calibration. Refer to description of **⊖** key and the Setup Review section of this manual for details.

TARE KEY (with diamond "T" symbol)

This is a dual function key. Pressing the **TARE** key alone (Pushbutton Tare mode) will store the current gross weight as a new tare weight and cause the weight display to change to the net weight display mode (**N** is shown on the annunciator display). Pressing the key after entering a numeric value (Keypad Tare) will cause the value entered to be accepted as a new tare weight.

NOTE! Tare weights equal to or greater than scale capacity cannot be entered. In addition, keypad tare weight division value must be same as scale division value. For example, a unit with .005 lb as division value will display **-ERROR** if you enter 1.003 for tare weight.

KEYPAD FUNCTIONS, Cont.

NET/GROSS KEY

This key is used to toggle between the Net and Gross weight modes. The selected mode is indicated by turning on **N** or **G** on the annunciator display. Note that if no valid tare weight has been entered, pressing this key will cause a momentary *no tARE* display error and the indicator will remain in the Gross weight mode.

TARE KEY (with weight "T" symbol)

Pressing this key will display the current tare weight for three seconds.

UNITS/TEST KEY

This key performs two functions. In normal operation, it is used to select the units in which the weight is to be displayed. The available units of measure ("unit1" and "unit2") are enabled or disabled in setup. The available units include tons, pounds, ounces, tonnes (metric tons), kilograms, and grams. Note that not all combinations are supported. Pressing this key after the **⊖** key will enter the Test mode. The Test mode is used to conduct a test of all display elements. Refer to description of **⊖** key for details.

0 THROUGH 9 KEYS

These keys are used to enter numeric data during the setup and calibration as well as during normal operation of the instrument. **NOTE!** The 1 and 0 keys have dual functions. They are used to enter numeric data during setup and calibration as well as during normal operations and are also used to answer yes (1 = YES) or no (0 = NO) to various prompts.

ENTER KEY

This key serves two purposes. First, when reviewing setup parameters, pressing the **ENTER** key will display the current setting of the parameter. Second, the **ENTER** key is used to signal completion of the entry of data and causes the indicator to process the data entered.

⊖ (ASTERISK) KEY

This key is used for several functions. During Setup, when a setup parameter (not a parameter value) is displayed, pressing it key will "backup" to the previous prompt. In normal operation, this key is used in conjunction with other keys on the keypad to access additional indicator features. These features and their associated key combinations are as follows:

⊖ and 1/0 KEY

This combination is used to adjust the brightness of the weight display. Refer to Display Brightness section of this manual for details.

⊖ and ZERO/REVIEW KEY

This combination will enter the Review mode of Setup and Calibration. Refer to Setup Review section of this manual for details.

⊖ and NET/GROSS KEY

This combination will display the Net accumulator.

⊖ and NET/GROSS KEY, PRINT KEY

This combination will print the Net accumulator.

⊖ and NET/GROSS KEY, ZERO KEY

This combination will zero (clear) the Net accumulator.

⊖ and NET/GROSS KEY, NET/GROSS KEY

This combination will display the Gross accumulator.

⊖ and NET/GROSS KEY, NET/GROSS KEY, PRINT KEY

This combination will print the Gross accumulator.

KEYPAD FUNCTIONS, Cont.

⊖ and NET/GROSS KEY, NET/GROSS KEY, ZERO KEY

This combination will zero (clear) the Gross accumulator.

⊖ and UNITS KEY

This combination will enter the Test mode. The Test mode is used to test of all the display elements. It consists of five (5) cycles, each lasting about one (1) second:

1. All horizontal segments will turn on.
2. All vertical segments and decimal points will turn on.
3. All annunciator display segments will turn on.
4. All display elements off.
5. The model number (210-FE) and the software version X.X.
6. The calibration numbers (C1 to C4).

⊖ and PRINT KEY

This combination is used to *change* the selected print ticket format. Pressing the ⊖ and then the **PRINT** key will display a prompt *P-r-t-*. Press the **ENTER** key to show the current value. If the setting displayed is acceptable, press the **ENTER** key again to save it. Otherwise, using the numeric keys enter the new setting and then press the **ENTER** key to save it. Allowable values are:

0 = print tab settings **1** = visual ticket format 1 **2** = visual ticket format 2

In addition to using the ⊖ and **PRINT** key combination to change the print ticket format, the operator (just prior to printing the ticket) can change the print ticket format at the end of the weighing operation. This is accomplished by performing the normal weighing operation and then pressing the desired format number (0, 1 or 2), followed by pressing the **PRINT** key.



NOTE! When a print format is selected (by either method), it will remain active until changed by the operator.

DISPLAY BRIGHTNESS

The 210-FE indicator has an extra-bright 2 1/2" LED weight display. Ten levels of brightness can be set from the 210-FE keypad by using a combination of the ⊖ key and the **1** or **0** key.

To Increase Brightness:

1. Press the ⊖ key and then the **1** key.
2. Repeat pressing the **1** key to increase the brightness to the desired level.
3. When the brightness is at the desired level, press the **ENTER** key to save the setting and return to normal operating mode.

To Reduce Brightness:

1. Press the ⊖ key and then the **0** key.
2. Repeat pressing the **0** key until the brightness has been reduced to the desired level.
3. When the brightness is at the desired level, press the **ENTER** key to save the setting and return to normal operating mode.

ANNUNCIATOR DISPLAY

The annunciator display is a three (3) character 16-segment display to the right of the weight display. It is used to indicate that the weight display is in the mode corresponding to the character(s) displayed or that the status indicated by the character(s) displayed is active.

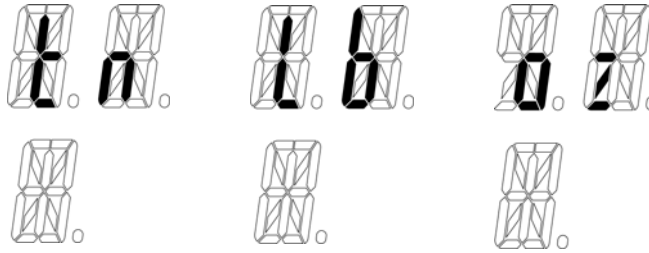

t_n

This is turned on to show that the displayed weight unit is tons. It is displayed in the two upper characters of the annunciator display.

l_b

This is turned on to show that the displayed weight unit is pounds. It is displayed in the two upper characters of the annunciator display.

o_z

This is turned on to show that the displayed weight unit is ounces. It is displayed in the two upper characters of the annunciator display.

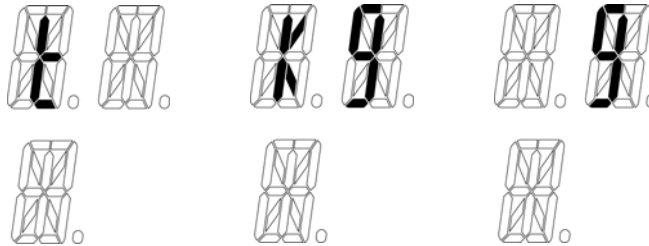

t

This is used to indicate that the displayed unit of weight measurement is tonnes (metric tons). It is displayed in the two upper characters of the annunciator display.

kg

This is used to indicate that the displayed unit of weight measurement is kilograms. It is displayed in the two upper characters of the annunciator display.

g

This is used to indicate that the displayed unit of weight measurement is grams. It is displayed in the two upper characters of the annunciator display.

ANNUNCIATOR DISPLAY, Cont.



NOTE! The *CZ*, *MO*, *PC* or *TL* is alternately displayed or replaces the weight units, when appropriate, in the upper two characters.

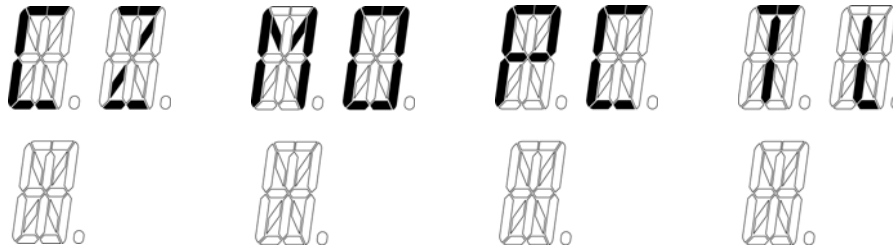

CZ

This indicates that the weight displayed is within $\pm 1/4$ division of the Center of Zero. It is displayed in the two upper characters of the annunciator display.

MO

This indicates that the change in successive weight samples is greater than the Motion limits selected during setup. It is displayed in the two upper characters of the annunciator display.

PC

This is used to indicate that the display is in the Count mode and the value displayed is the count quantity and not weight. It is displayed in the two upper characters of the annunciator display.

TL

This is used to indicate that the display is in the Count mode and that the value displayed is the current contents (total) of the count accumulator. It is displayed in the two upper characters of the annunciator display.

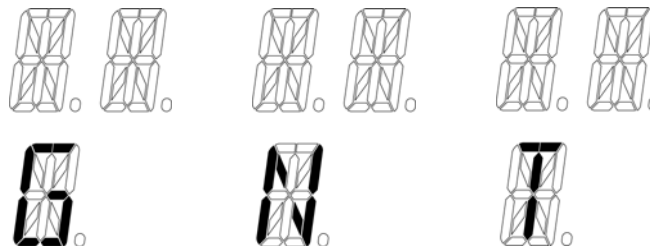

G

This is turned on to show that Gross weight is displayed. Gross weight will be displayed when no tare weight is stored. It is displayed in the lower character of the annunciator display.

N

This is turned on to show that the displayed weight is the Net weight (gross weight less tare weight). It is displayed in the lower character of the annunciator display.

T

This is turned on to show that the displayed weight is the Tare weight. It is displayed in the lower character of the annunciator display.

SETUP AND CALIBRATION

Your Model 210-FE indicator has been thoroughly tested and calibrated before being shipped to you. If you received the indicator attached to a scale, calibration is not necessary. If the indicator is being connected to a scale for the first time or recalibration is necessary for other reasons, proceed as indicated.

The calibration switch is located on a bracket on the inside of the enclosure rear panel. You may gain access to this switch simply by removing the calibration switch access screw on the rear panel. Refer to Figures No. 11 and 12.



Figure No. 11

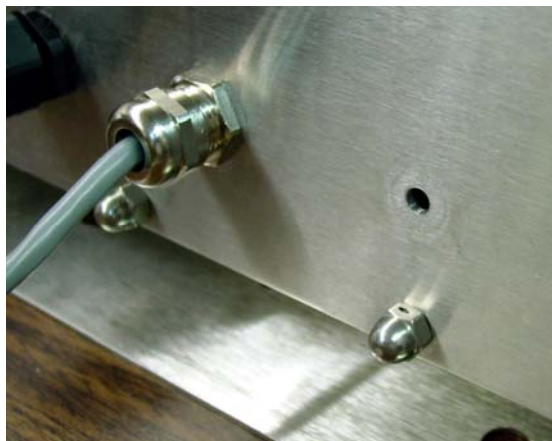

Figure No. 12

Enter Setup Mode

With the 210-FE indicator ON;

1. Insert a small screwdriver or other tool through the calibration switch access hole on the rear panel. Refer to Figure No. 13.
2. Press and release the calibration switch.
3. The menu Setup will be displayed.
4. Continue to press and release the switch to rotate through the beginning point for entering the setup mode.



Figure No. 13

<i>SEtUP</i>	Setup Mode (starts at <i>USR</i> prompt)
<i>A-d</i>	Analog to Digital Filtering (starts at <i>dFLt =</i> prompt)
<i>CRl</i>	Calibration (starts at <i>CRl 1</i> prompt)
<i>SIO</i>	Serial Input/Output (starts at <i>bRud</i> prompt)
<i>Prnt</i>	Print Tab Settings (starts at <i>Prnt</i> prompt)
<i>FSPAn</i>	Fine Span Adjustment
<i>HrES</i>	Display high resolution weight mode
<i>LcOUt</i>	Key lock out function

SETUP AND CALIBRATION, Cont.



DO NOT operate the keypad with pointed objects (pencils, pens, etc).
Damage to keypad resulting from this practice is **NOT** covered under warranty.

During the setup and calibration process it is necessary to enter operational parameters via the indicator's keypad. Pressing the **ENTER** key without entering a new value will retain the current setting and advance to the next prompt. To change a setting, enter a new value and press the **ENTER** key. This will save the new value and advance to the next prompt. Pressing the **⊖ (ASTERISK)** key will "backup" to the previous prompt.

If you press the **ENTER** key at the *SEtUP* prompt, you may proceed through to the next section (up to and including *F5PRn*) by pressing the **ENTER** key.



NOTE! Setup may be interrupted at any time. **ALL** data previously entered and finalized with the **ENTER** key will be retained in the non-volatile memory.

Pressing the calibration switch *at any prompt* will return you to the *SEtUP* menu. To exit setup, press the **⊖** key with any of the above menu selections displayed or cycle power at any time (press the **ON/OFF** key twice).

NOTE! With the exception of the *SEtUP* prompt, the prompts displayed for each section are different if you push the calibration switch instead of pressing the **ENTER** key to proceed through the section. For example, if you press the calibration switch with the *SEtUP* displayed, the next prompt displayed will be *R-d*. If you step through the setup prompts by pressing the **ENTER** key, the next prompt displayed will be *R-d?*. In addition, at a prompt with the question mark (*?*) displayed, you must press the **ENTER** key, the **1/YES** key and then the **ENTER** key again to proceed with that section. To skip the section and advance to the next menu selection, press the **ENTER** key twice.

SEtUP

USR = (Domestic or International)

With *SEtUP* displayed, press the **ENTER** key. The display will change to *USR* = . Press the **ENTER** key to show the current value. If the setting displayed is acceptable, press the **ENTER** key again to save it. Otherwise, using the numeric keys, **0/NO** or **1/YES**, enter the new setting and then press the **ENTER** key to save it.

USR = 1 (Domestic)

dRtE = mm/dd/yy

tL = no

CRP + 4% to OC

USR = 0 (International)

dRtE = dd/mm/yy

tL = YES

CRP + 9 grads to OC

PT printed with tare

Lamp test on power up

If you selected *USR* = 0 (International), an additional prompt, *PRSS* = will be displayed.

If you selected *USR* = 1 (Domestic) proceed to *LFL* = (Legal For Trade).

SETUP AND CALIBRATION, Cont.

PASS (Password Y/N)

The *PASS* (Password Y/N) prompt determines whether a password is required to enter Setup and Calibration on indicators programmed for international use. Note that this prompt is only displayed when *USA = 0* (International) is selected.

With the display showing **PASS**, press the **ENTER** key to show the current value. If the setting displayed is acceptable, press the **ENTER** key again to save it. Otherwise, using the numeric keys, **0/NO** or **1/YES**, enter the new setting, then press the **ENTER** key to save it.

<i>PASS</i> (NO)	<i>PASS</i> (YES)
Password protection is NOT needed. Setup advances to the <i>LFT=</i> prompt.	Password protection is desired. The next prompt will be <i>PASS=</i>

Press the **ENTER** key to see the current password value. If the password displayed is acceptable, press the **ENTER** key again to save it. Otherwise, using the numeric keys enter the new password (up to 6 digits) and then press the **ENTER** key to save it.

Password Operation

With the *PASS* prompt enabled (set to YES), anytime the operator tries to enter *SEtUP*, the display will show the *PASS=* prompt requiring the operator to enter the correct password. If the wrong password is entered the indicator displays *ERROR* momentarily and returns to the weight mode. Note that the password is not shown on the display when the operator is entering it.

NOTE! It is recommended to write the password down and store it in a secure location. If the password is forgotten or lost and a change to the indicator setup is required, the indicator must be reprogrammed. **WARNING!** Reprogramming the indicator will erase all the contents of the Nov-Ram and memory.

LFT = (Legal For Trade)

Press the **ENTER** key to show the current value. If the setting displayed is acceptable, press the **ENTER** key again to save it. Otherwise, using the numeric keys, **0/NO** or **1/YES**, enter the new setting and then press the **ENTER** key to save it.

LFT = 1

Interval Settings (*Int =*) allowed are: 1, 2, 5, 10, 20, 50

LFT = 0

Interval Setting (*Int =*) is selectable from 1 to 99.

NOTE! When both *LFT = 1* and *USA = 1*, the followings results occur:

Scale must have between 100 and 10,000 divisions

ERR = .5 or 0 to 3

Inhibit serial data during input

Disables **COUNT** key

DATE = mm/dd/yy

ERR = no

CRP + 4% to OC

NOTE! When *LFT = 1* and *USA = 0*, the followings results occur:

UNS = 1

DATE = dd/mm/yy

ERR = yes

CRP + 9 grads to OC

PT printed with tare

Lamp test on power up

SETUP AND CALIBRATION, Cont.

Unit 1: (Weighing Unit 1)

Press the **ENTER** key to show the current value. If the setting displayed is acceptable, press the **ENTER** key again to save it. Otherwise, using the numeric keys enter the new setting and then press the **ENTER** key to save it. Allowable values are:

0 = none	4 = oz (ounces)
1 = tn (tons)	5 = kg (kilograms)
2 = g (grams)	6 = tonnes (metric tons)
3 = lb (pounds)	

Int: (Interval Setting)

Press the **ENTER** key to show the current value.

If $LF\bar{T} = 1$ (Legal For Trade = YES), using the numeric keys enter the new setting and then press the **ENTER** key to save it. Allowable values are: 1, 2, 5, 10, 20 or 50.

If $LF\bar{T} = 0$ (Legal For Trade = NO), using the numeric keys enter the new setting and then press the **ENTER** key to save it. Allowable values are: 1 through 99.

In either case, if the setting displayed is acceptable, press the **ENTER** key again it.

dPP: (Decimal Point Setting)

Press the **ENTER** key to show the current value. If the setting displayed is acceptable, press the **ENTER** key again to save it. Otherwise, using the numeric keys enter the new setting and then press the **ENTER** key to save it. Allowable values are: 0, 1, 2 or 3.

0 = XXXXXX	2 = XXXX.XX
1 = XXXXX.X	3 = XXX.XXX

CRP: (Capacity)

Press the **ENTER** key to show the current value. If the setting displayed is acceptable, press the **ENTER** key again to save it. Otherwise, using the numeric keys enter the new setting and then press the **ENTER** key to save it. Allowable values are: 1 through 999,999.

NOTE! Capacity cannot exceed 999,999.

Unit 2: (Weighing Unit 2)

Press the **ENTER** key to show the current value. If the setting displayed is acceptable, press the **ENTER** key again to save it. Otherwise, using the numeric keys enter the new setting and then press the **ENTER** key to save it. Allowable values are:

0 = none	4 = oz (ounces)
1 = tn (tons)	5 = kg (kilograms)
2 = g (grams)	6 = tonnes (metric tons)
3 = lb (pounds)	



NOTE! The selection for Unit 2 can not be the same as Unit 1. In addition, dependent upon the selection for Unit1 and the interval and decimal point settings, not all unit combinations are available.

TR: (Zero Tracking Range)

Press the **ENTER** key to show the current value. If the setting displayed is acceptable, press the **ENTER** key again to save it. Otherwise, using the numeric keys enter the new setting and then press the **ENTER** key to save it. Allowable values are: 0 (disables Zero Tracking), .5, or 1 through 9.

SETUP AND CALIBRATION, Cont.

trL = (4% Zero Range)

Press the **ENTER** key to show the current value. If the setting displayed is acceptable, press the **ENTER** key again to save it. Otherwise, using the numeric keys, **0/NO** or **1/YES**, enter the new setting and then press the **ENTER** key to save it.

trL = 1 (Yes)
4% of scale capacity

trL = 0 (No)
Full capacity (no limit)

PUD = (Power-Up Zero Feature)

Press the **ENTER** key to show the current value. If the setting displayed is acceptable, press the **ENTER** key again to save it. Otherwise, using the numeric keys, **0/NO** or **1/YES**, enter the new setting and then press the **ENTER** key to save it.

PUD = 1 (Yes)
Automatic Re-Zero on Power-Up

PUD = 0 (No)
No Re-Zero on Power-Up

td = (12 or 24 Time Format)

Press the **ENTER** key to show the current value. If the setting displayed is acceptable, press the **ENTER** key again to save it. Otherwise, use the numeric keys to select the format (12 or 24 hour) clock operation and then press the **ENTER** key to save it. Note that in the 24 hour format, 12 is added to all times after noon, i.e. 3 PM would be 1500.

td = 12
12 hour clock (3PM displays 3:00)

td = 24
24 hour clock (3PM displays 15:00)

d out = X, Y (Digital Output)

Press the **ENTER** key to show the current value. If the setting displayed is acceptable, press the **ENTER** key again to save it. Otherwise, use the numeric keys to select the X, Y values for the digital output and then press the **ENTER** key to save it.

d out = X, Y

where: X = State below cutoff (0 = LOW, 1 = High)
Y = Preset Number or Checkweigher Mode

- 0** = Digital Output is disabled
- 1** = Low State before cutoff with 1 active Preset
- 2** = Low State before cutoff with 2 active Presets
- 3** = Low State before cutoff with 3 active Presets
- 11** = High state before cutoff with 1 active Preset
- 12** = High state before cutoff with 2 active Presets
- 13** = High state before cutoff with 3 active Presets
- 4** = Low State before cutoff on Checkweigher Mode
- 14** = High state before cutoff on Checkweigher Mode
- 5** = Axle Weigher Operation Mode

SETUP AND CALIBRATION, Cont.

P - bAL : (Preset Print-On-Balance)

With only one Preset selected (*dOUT* = 1 or 11), an additional prompt *P - bAL* : (automatic Print on Balance) will be displayed. If selected (*P - bAL* : YES), when weight is above or equals the preset value and all motion stops, weight will be printed (if a printer is attached). The weight must go below 50% of the preset value before another print operation can be performed.

If the setting displayed is acceptable, press the **ENTER** key to save it. Otherwise, using the numeric keys, **0/NO** or **1/YES**, enter the new setting and then press the **ENTER** key to save it.

P - bAL : 1 (Yes)

Automatic Print on Balance Enabled

P - bAL : 0 (No)

Automatic Print on Balance Disabled

P - bAL : (Checkweigher Print-On-Accept)

With Checkweigher selected (*dOUT* = 4 or 14), an additional prompt *P - bAL* , Print on Balance, (automatic print on accept) will be displayed. If selected (*P - bAL* : YES), when the scale weight is stable and in the accept range of the checkweigher, the weight will be printed (if a printer is attached).

If the setting displayed is acceptable, press the **ENTER** key to save it. Otherwise, using the numeric keys, **0/NO** or **1/YES**, enter the new setting and then press the **ENTER** key to save it.

P - bAL : 1 (Yes)

Automatic Print on Accept Enabled

P - bAL : 0 (No)

Automatic Print on Accept Disabled

SLEEP : (Sleep Mode Feature)

The Sleep Mode feature conserves battery power when the indicator remains unused for a selected period of time. With the feature enabled, the load cell excitation will be reduced and the display will be blank.

Press the **ENTER** key to show the current status of this feature. If a number other than 0 is shown, this feature is selected and the number shown corresponds to the number of minutes of a stable zero weight reading before the indicator enters the sleep mode. If the setting displayed is acceptable, press the **ENTER** key again to save it. Otherwise, use the numeric keys to enter a new value (0 to 10) and then press the **ENTER** key to store the new setting. Note that entry of a 0 disables this feature.

ROFF : (Auto Shutoff)

The Automatic Shutoff feature will automatically turn the indicator off (when it is not in use) after a predetermined period of inactivity to prolong battery life. To turn the instrument back on you must press the **ON / OFF** key.

Press the **ENTER** key to show the current status for this feature. A number other than 0 indicates that the auto shutoff feature is enabled and the displayed number corresponds to the number of minutes of stable weight displayed before the indicator is turned off automatically. Note that a 0 indicates the feature has been turned off. If the setting displayed is acceptable, press the **ENTER** key again to save it. Otherwise, use the numeric keys to enter a new value (0 to 10) and then press the **ENTER** key to store the new setting.

SETUP AND CALIBRATION, Cont.

CLTAR = (Clear Tare)

The Clear Tare feature allows the indicator to clear the Stored Tare weight when the Net weight goes below a value greater than 1/2 the stored tare weight or goes below zero (a negative net weight after display of a positive net weight). With this feature enabled, the operator must re-set the tare after completion of a transaction when the load (container plus item) is removed from the scale.

Press the **ENTER** key to show the current value. If the setting displayed is acceptable, press the **ENTER** key again to save it. Otherwise, using the numeric keys, **0/NO** or **1/YES**, enter the new setting and then press the **ENTER** key to save it.

CLTAR = 1 (Yes)

Automatically clears Stored Tare when Net weight goes below zero

CLTAR = 0 (No)

Stored Tare is not cleared when Net weight goes below zero

The following is a typical example of the Clear Tare feature in use.

1. Place container on scale, then press **TARE** key (with diamond "T" symbol).
2. Load container with item to be weighed and perform normal weighing operation.
3. Remove load (item *AND* container) from scale.
4. Scale weight returns to below zero (weight of container) and is then reset to zero.
5. Operator is required to repeat step 1 before next weighing operation.

ID = (ID Prompt)

The **ID = (ID=)** prompt enables an ID prompt before printing a ticket.

With the display showing **ID =**, press the **ENTER** key to show the current value. If the setting displayed is acceptable, press the **ENTER** key again to save it. Otherwise, using the numeric keys, **0/NO** or **1/YES**, enter the new setting and then press the **ENTER** key to save it.

ID = 1 (Yes)

ID = will be displayed when **PRINT** key is pressed and printed on the ticket.

ID = 0 (No)

Normal print operation (no ID prompt) will occur.

If you selected **ID = 1 (Yes, ID Prompt)**, an additional prompt, "**ACID =**" will be displayed.

If you selected **ID = 0 (No ID Prompt)** proceed to **ACID (ACID?)** Analog to Digital Filtering.

ACID = (Auto Clear ID)

The **ACID = (Auto Clear ID)** prompt determines whether the ID is automatically cleared after printing the ticket. Note that it is only displayed when **ID = YES** is selected.

With the display showing **ACID =**, press the **ENTER** key to show the current value. If the setting displayed is acceptable, press the **ENTER** key again to save it. Otherwise, using the numeric keys, **0/NO** or **1/YES**, enter the new setting and then press the **ENTER** key to save it.

ACID = 1 (Yes)

Automatically clears the ID after the ticket has printed.

ACID = 0 (No)

ID is not cleared when ticket prints and can be used for next transaction.

SETUP AND CALIBRATION, Cont.

$R-d$ ($R-d^2$) - Analog to Digital Filtering

$dFLt$ - (Digital Filtering)

With $R-d$ ($R-d^2$) displayed, press the **ENTER** key. The display will change to $dFLt$ -. Press the **ENTER** key to show the current value. If the setting displayed is acceptable, press the **ENTER** key to save it. Otherwise, using the numeric keys enter the new setting and then press the **ENTER** key to save it. Allowable values are: 0, 1, 2 or 3. Note that if you select 3 (Custom Filtering) two additional prompts will be displayed.

$dFLt$ -

- | | |
|---|--------------------------------------|
| 0 | Disabled – NO Filtering |
| 1 | MINIMAL FILTERING (sample rate = 2) |
| 2 | MODERATE FILTERING (sample rate = 1) |
| 3 | CUSTOM FILTERING |

NOTE! The prompts, F - (Filter Level) and b - (Break Range) will only be displayed if you selected 3 (Custom Filtering) for the $dFLt$ - (Digital Filtering) prompt.

F - (Filter Level)

Press the **ENTER** key to show the current setting for the filter level. The filter level is a number from 1 to 99 that corresponds to the level of filtering with 1 the least and 99 being the greatest filtering. To accept the value displayed, press the **ENTER** key, otherwise, use the numeric keys to enter a new value and then press the **ENTER** key to save it.

b - (Break Range)

Press the **ENTER** key to show the current setting for the break range. The break range is a number from 1 to 255 that corresponds to the number of division change to break out of the filtering. Press the **ENTER** key to keep the displayed value or use the numeric keys to enter a new value and then press the **ENTER** key to save the new setting. Note that entry of a 0 disables this feature.

Sr - (Sample Rate)

Press the **ENTER** key to show the current setting for the sample rate. The value displayed is the sample rate in samples per second. Press the **ENTER** key to save the displayed value or use the numeric keys to enter a new value (1 to 100) and then press the **ENTER** key to save it.

UnS - (Motion Range)

Press the **ENTER** key to view the current setting for the range of motion detection. If the displayed value is acceptable, press the **ENTER** key to save it. Otherwise, use the numeric keys to enter the new range (the number of divisions of change permitted before indicating unstable) and then press the **ENTER** key to save the new setting. Allowable range values are: 0 through 99 divisions.

SC - (Stable Count)

Press the **ENTER** key to view the current setting for the number of consecutive stable weight readings before indicating stable weight. This helps filter weight readings for stability for use with Auto Print on Balance, or and anything trying to capture stable weight. If the displayed value is acceptable, press the **ENTER** key to save it. Otherwise, use the numeric keys to enter a new value and then press the **ENTER** key to save the new setting. Allowable values for the stable count are: 3 through 255.

SETUP AND CALIBRATION, Cont.

FILTER SETTING RECOMMENDATIONS

Non Critical Sample Rate

If the sample rate is not critical, as in static weighing, set $dFLt$ to "0" (no filtering), $dFLt = "1"$ ($F=6$, $b=12$, $Sr = 2/Sec$), or $dFLt = "2"$ ($F=6$, $b=8$, $Sr = 1/Sec$).

Critical Sample Rate

If the sample rate is critical, as in a filling operation, use the Custom Filtering (set $dFLt$ to "3").

1. $Sr =$ SAMPLE RATE (1 to 100 samples/second) determination:

Set the sample rate as close as possible to produce a display graduation change for every graduation of material added to the scale.

$$\frac{\text{Material Flow Rate (lbs/second)}}{\text{Resolution}} = Sr$$

EXAMPLE: $\frac{100\text{lbs/sec}}{10\text{lbs}} = 10\text{s/s} = Sr$

2. $b =$ BREAK RANGE (1 to 255 graduations) determination:

Turn the filtering off by setting the $dFLt$ setting to "0". Operate the system as it will be normally used and, by observation, determine the number of grads of instability that needs to be filtered out. Set the break range ($b =$) to that value.

$$\frac{\text{Weight Change}}{\text{Graduation Value}} = b$$

EXAMPLE:
20,000 x 10lb capacity scale with 800lb variation in the weight display.

$$\frac{800}{10} = b = 80$$

3. $F =$ FILTER SETTING (1 to 99) determination: Set to desired results.
4. If stability is unacceptable with any setting of $F =$, reduce the sample rate and/or increase the break range, $b =$ setting for increased filtering.

SETUP AND CALIBRATION, Cont.

CR (CR) - Calibration

With CR (CR) displayed, press the **ENTER** key. The display will change to show the current setting $n0$. If calibration is desired, press the **1/YES** key, then press the **ENTER** key to continue to the CR 1= setting, otherwise press the **ENTER** key to advance to the S_{10} menu.

CALIBRATION MODES

The 210-FE has five modes that can be used to perform calibration. Three of the modes require a test load or test weights, one requires the scale to be empty (and at zero) and the last uses the calibration “C” numbers from a previous calibration. The modes are as follows:

1. Dual-Point with Zero (First Zero)

This is a standard calibration method requiring one weight, an empty scale and has one conversion factor. This method uses two calibration points (CR 1= and CR 2=) to establish a zero (no load) calibration value and to span the indicator. The two points correspond to zero weight and the test load or test weight and can be applied in any order. This method should be used for first-time calibration and complete recalibration.

2. Dual-Point without Zero (False Zero)

This calibration method requires one test weight and establishes a new conversion factor only. It is used to establish a false (temporary zero) zero without affecting the zero calibration value stored during the last calibration. This is particularly useful in tank weighing applications, where it may be impractical or impossible to completely empty the tank. This method uses two calibration points, CR 1= and CR 2=. The value of the test weight is entered when CR 1= is displayed and the **NET/GROSS** key is pressed when CR 2= is displayed.

3. Single-Point for Span Only (Last Zero)

This calibration method requires one test weight and establishes a new conversion factor (span) without affecting the zero calibration value stored during the last calibration. This minimizes placing and removing test weights and is especially useful when checking high capacity scales. This method uses two calibration points, CR 1= and CR 2=. The value of the test weight is entered when CR 1= is displayed and the **ZERO** key is pressed when CR 2= is displayed.

4. Single-Point for Zero Only (Only Zero)

This calibration method requires no test weight, an empty scale and establishes a new zero without affecting the conversion factor (span). This is useful to regain the full range of zero limit when the dead load of the scale has changed. This would occur for example, if a guard rail has been added to the scale platform. This method uses two calibration points, CR 1= and CR 2=. The **ENTER** key is pressed when CR 1= is displayed and the **ZERO** key is pressed when CR 2= is displayed.

5. Calibration “C” Numbers

The calibration “C” numbers (C 1, C 2, C 3 and C 4) are displayed only during the Test mode operation and are shown at the end of the test. Each number is displayed for approximately 4 seconds, allowing you to record them. These numbers correspond to the calibration setting of the indicator. The numbers may be up to three digits in length. By recording these numbers you will be able to return the indicator to its present calibration settings without using test weights simply by entering the “C” numbers. *Refer to the Calibration “C” Number section of this manual for instructions on viewing the “C” numbers.*

SETUP AND CALIBRATION, Cont.

Dual-Point with Zero (First Zero) Calibration

CR1 - FIRST CALIBRATION WEIGHT

The display will show CR1=0. This is the first of two calibration weights. This weight could be ZERO (NO LOAD) or the TEST WEIGHTS / TEST LOAD.

- If the first calibration weight is to be ZERO (NO LOAD), press the **ENTER** key.
- If the first calibration weight is to be the TEST WEIGHTS / TEST LOAD, use the numeric keys to input the value of the calibrated test weights. **NOTE!** When entering values for CR1, the digits start displaying on the right side of the display and proceed to the left. When large values are used (more than 3 digits), the CR1 prompt will automatically scroll off the left side of the display to show the additional digits on the right as they are entered.
- Place the weights on the scale platform and then press the **ENTER** key.
- Starting at the left and proceeding right, a series of dashes will appear on the display. The dashes will stay on the display momentarily, then disappear, after which the display will show: CR2=.

CR2 - SECOND CALIBRATION WEIGHT

The display will show CR2=0. This is the second of two calibration weights. This weight could be ZERO (NO LOAD) or the TEST WEIGHTS / TEST LOAD.

- If the second calibration weight is to be ZERO (NO LOAD), press the **ENTER** key.
- If the second calibration weight is to be the TEST WEIGHTS / TEST LOAD, use the numeric keys to input the value of the calibrated test weights. **NOTE!** When entering values for CR2, the digits start displaying on the right side of the display and proceed to the left. When large values are used (more than 3 digits), the CR2 prompt will automatically scroll off the left side of the display to show the additional digits on the right as they are entered.
- Place the weights on the scale platform and then press the **ENTER** key.
- Starting at the left and proceeding right, a series of dashes will appear on the display. The dashes will stay on the display momentarily and then disappear, after which the display will show: 5.00.

Dual-Point without Zero (False Zero) Calibration

CR1 - FIRST CALIBRATION WEIGHT

The display will show CR1=0. This is the first of two calibration steps. This weight is the TEST WEIGHTS / TEST LOAD.

- Place the weights on the scale platform.
- Using the numeric keys, input the value of the calibrated test weights / test load and then press the **ENTER** key. **NOTE!** When entering values for CR1, the digits start displaying on the right side of the display and proceed to the left. When large values are used (more than 3 digits), the CR1 prompt will automatically scroll off the left side of the display to show the additional digits on the right as they are entered.
- Starting at the left and proceeding right, a series of dashes will appear on the display. The dashes will stay on the display momentarily, then disappear, after which the display will show: CR2=.

CR2 - SECOND CALIBRATION WEIGHT

The display will show CR2=0. This is the second of two calibration steps.

- Remove the weights on the scale platform and then press the **NET/GROSS** key.
- Starting at the left and proceeding right, a series of dashes will appear on the display. The dashes will stay on the display momentarily, then disappear, after which the display will show: 5.00.

SETUP AND CALIBRATION, Cont.

Single-Point for Span Only (Last Zero) Calibration

CAL 1= – FIRST CALIBRATION WEIGHT

The display will show CAL 1=0. This is the first of two calibration steps. This weight is the TEST WEIGHTS / TEST LOAD.

- Zero the scale and then place the weights on the scale platform.
- Using the numeric keys, input the value of the calibrated test weights / test load, then press the **ENTER** key. **NOTE!** When entering values for CAL 1=, the digits start displaying on the right side of the display and proceed to the left. When large values are used (more than 3 digits), the CAL 1= prompt will automatically scroll off the left side of the display to show the additional digits on the right as they are entered.
- Starting at the left and proceeding right, a series of dashes will appear on the display. The dashes will stay on the display momentarily, then disappear, after which the display will show: CAL 2=.

CAL2= - SECOND CALIBRATION WEIGHT

The display will show CAL 2=0. This is the second of two calibration steps.

- Remove the weights on the scale platform and then press the **ZERO** key.
- The display will advance to 5.00.

Single-Point for Zero Only (Only Zero) Calibration

CAL 1= – FIRST CALIBRATION WEIGHT

The display will show CAL 1=0. This is the first of two calibration steps.

- Insure the scale is empty.
- Press the **ENTER** key.
- Starting at the left and proceeding right, a series of dashes will appear on the display. The dashes will stay on the display momentarily, then disappear, after which the display will show: CAL 2=.

CAL 2= - SECOND CALIBRATION WEIGHT

The display will show CAL 2=0. This is the second of two calibration steps.

- Press the **ZERO** key.
- The display will advance to 5.00.

Calibration “C” Numbers

1. With CAL 1= displayed, press the "diamond T" TARE key.
2. At the C 1= prompt, press the **ENTER** key to show the current value of the C1 number.
3. If the C 1= number displayed is acceptable, press the **ENTER** key again to save it.
4. Otherwise, use the numeric keys to enter a new C 1= number and then press the **ENTER** key.
5. Repeat steps 2 through 4 for C 2=, C 3= and C 4=.



NOTE! If any components have been changed that affect calibration and/or your scale is used in a commercial application and must be "Legal for Trade" you cannot use the “C” numbers to re-calibrate.

SETUP AND CALIBRATION, Cont

5 10 (5 10?) - Serial Input/Output

With 5 10 (5 10?) displayed, press the **ENTER** key. The display will change to show the current setting "n0". To skip configuring the 5 10 (serial input/output) and proceed to the **Prnt?** menu, press the **ENTER** key again. To configure the 5 10, press the numeric key **1/YES** and then the **ENTER** key. The display will change to **baud:**.

baud: (Serial Port Baud Rate)

Press the **ENTER** key to show the current value. If the setting displayed is acceptable, press the **ENTER** key again to save it. Otherwise, use the numeric keys to enter a new baud rate for the serial ports and then press the **ENTER** key to save it. Allowable values are:

12 = 1200 Baud	24 = 2400 Baud	48 = 4800 Baud
96 = 9600 Baud	19 = 19.2k Baud	38 = 38.4k Baud
76 = 76.8k Baud		

Prnt? (Serial Port Parity)

Press the **ENTER** key to show the current value. If the setting displayed is acceptable, press the **ENTER** key again to save it. Otherwise, using the numeric keys enter the new setting and then press the **ENTER** key to save it. Allowable values are: 0, 1, or 2.

0 = NONE (No Parity)	1 = Odd Parity	2 = Even Parity
----------------------	----------------	-----------------

bits: (Serial Port Data Bits)

Press the **ENTER** key to show the current value. If the setting displayed is acceptable, press the **ENTER** key again to save it. Otherwise, using the numeric keys enter the new setting and then press the **ENTER** key to save it. Allowable values are: 7 or 8.

stop: (Serial Port Stop Bits)

Press the **ENTER** key to show the current value. If the setting displayed is acceptable, press the **ENTER** key again to save it. Otherwise, using the numeric keys enter the new setting and then press the **ENTER** key to save it. Allowable values are: 1 or 2.

Cont 1: (Continuous Output Serial Port 1)

Press the **ENTER** key to show the current value. If the setting displayed is acceptable, press the **ENTER** key again to save it. Otherwise, using the numeric keys, **0/NO** or **1/YES**, enter the new setting and then press the **ENTER** key to save it.

Cont 1: 1 (Yes) Continuous Output	Cont 1: 0 (No) No Continuous Output
--------------------------------------	--

If you selected **Cont 1: 1** (Yes Continuous Output), an additional prompt, **TYPE:** will be displayed.

If you selected **Cont 1: 0** (No Continuous Output) proceed to the Weight On Demand section.

TYPE: (Continuous Output Format)

Press the **ENTER** key to show the current value. If the setting displayed is acceptable, press the **ENTER** key again to save it. Otherwise, using the numeric keys enter the new setting and then press the **ENTER** key to save it. Allowable values are:

0 = SMA	1 = SB-400	2 = SB-200	3 = Rice Lake IQ355
4 = AnDFV	5 = WI110	6 = Number	7 = Toledo Short

SETUP AND CALIBRATION, Cont

If SMA is selected, the data will be transmitted in the following format:

```
<lf><s><r><n><m><f><xxxxxx.xxx><uuu><cr>
```

Where:

lf =	Line Feed	
s =	Flags	Z= center of Zero, O = Overcap, E = zero Error, e = weight not currently being displayed
r =	Range	1, 2, 3, ...
n =	Mode	G = Gross, T = Tare, N = Net
m =	Motion	M = Motion, " "(blank) = no motion
f =	Custom	Custom flag
xxxxxx.xxx =	Weight	Six digits with decimal point
uuu =	Units	ton, lb, l/o, oz, t, kg, g
cr =	Carriage Return	(hex 0D)

If SB-400* or Computer is selected, the data will be transmitted in the following format:

```
<s><xxxxxx><d><uu><m><cc><cr>
```

Where:

s =	Sign	"-" = negative, " "(blank) = positive
xxxxxx.xxx =	Weight	Six digits
d =	Decimal point	Added to string if enabled in setup
uu =	Units	tn, lb, l/o, oz, t, kg, g
m =	Mode	G = Gross, N = Net
cc =	Weight Status	OC = overcap CZ = center of zero MO = motion ee = weight not currently being displayed
cr =	Carriage Return	(hex 0D)

*The SB-80, SB-300 (*multiple displays not supported*) and WinVRS use the SB-400 format.

If SB-200 is selected, the data will be transmitted in the following format:

```
<cr><s><xxxxxx><d><c><uu><m> ETX
```

Where:

cr =	Carriage Return	(hex 0D)
s =	Sign	"-" = negative, " "(blank) = positive
xxxxxx.xxx =	Weight	(with leading zeros)
d =	Decimal point	Embedded into weight (after weight dpp=0)
c =	status	m = motion o = overcap e = weight not currently being displayed
uu =	Units	tn, lb, l/o, oz, t, kg, g
m =	Mode	G = Gross, N = Net
ETX =	End of TeXt	(hex 03) MUST terminate ALL serial commands

If Rice Lake IQ355 is selected, the data will be transmitted in the following format:

```
<stx><s>xxxxxxx<u><m><s><cr><lf>
```

If AnDFV is selected, the data will be transmitted in the following format:

```
<hdr1>,xxxxx<uu><cr><lf>
```

SETUP AND CALIBRATION, Cont

If WI110 is selected, the data will be transmitted in the following format:

```
<m><sp><s>xxxxx<sp><uu><cr><lf>
```

If number only is selected, the data will be transmitted in the following format:

```
xxxxxx<cr><lf>
```

If Toledo Short is selected, the data will be transmitted in the following format:

```
<stx><swa><swb><swc>xxxxxx<cr><sum>
```

Weight On Demand

If continuous output has not been selected for Serial Port 1 (Cont1=NO), the 210-FE indicator will respond to a weight request (ENQ).

The host device (computer) sends:

ENQ - (hex 05)

The 210-FE will respond:

```
<s><xxxxxx><d><uu><m><cc><cr>
```

Where:

s =	Sign	"-" = negative, " " (<i>blank</i>) = positive
xxxxxx.xxx =	Weight	Six digits
d =	Decimal point	Added to string if enabled in setup
uu =	Units	tn, lb, l/o, oz, t, kg, g
m =	Mode	G = Gross, N = Net
cc =	Weight Status	OC = overcap CZ = center of zero MO = motion ee = weight not currently being displayed
cr =	Carriage Return	(hex 0D)

NOTE! The Weight On Demand function is not available for Serial Port 2.

Cont2: (Continuous Output Serial Port 2)

Press the **ENTER** key to show the current value. If the setting displayed is acceptable, press the **ENTER** key again to save it. Otherwise, using the numeric keys, **0/NO** or **1/YES**, enter the new setting and then press the **ENTER** key to save it.

Cont2: 1 (Yes)

Continuous Output

Cont2: 0 (No)

No Continuous Output

If Cont2: Yes (Continuous Output) is selected, an additional prompt, *TYPE:* will be displayed.

TYPE: (Continuous Output Format)

Press the **ENTER** key to show the current value. If the setting displayed is acceptable, press the **ENTER** key again to save it. Otherwise, using the numeric keys enter the new setting and then press the **ENTER** key to save it. Allowable values are:

0 = SMA	1 = SB-400	2 = SB-200	3 = Rice Lake IQ355
4 = AnDFV	5 = WI110	6 = Number	7 = Toledo Short

NOTE! See Continuous Output Serial Port 1, *TYPE:* for description of output formats.

SETUP AND CALIBRATION, Cont

Print (Print) - Print Tab Settings

With *Print (Print)* displayed, press the **ENTER** key. The display will change to show the current setting "00". To skip configuring Print Tab Settings and proceed to the *FSRN* menu, press the **ENTER** key again. To configure Print Tab Settings, press the numeric key **1/YES** and then the **ENTER** key. After pressing the **ENTER** key the display will change to *Port*.

The general format for the input is A = YY.XX where A is the character identifying the data printed, YY is the number of lines down and XX is the number of spaces to the right.



NOTE! Enter 00 in either location, YY or XX, to disable the data from printing.

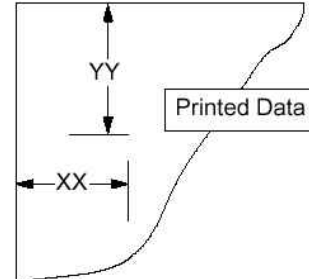

Port: (Select Port for Printer)

Press the **ENTER** key to show the current value. If the setting displayed is acceptable, press the **ENTER** key again to save it. Otherwise, use the numeric keys to enter a new setting and then press the **ENTER** key to save it. Allowable values are: 1 or 2.



NOTE! Although either port can be used for the printer port, it is recommended to use the bi-directional port 1 with a bi-directional cable.

Hour: (Time Print Location)

Press the **ENTER** key to show the current setting for the location of time printing. If the setting displayed is acceptable, press the **ENTER** key again to save it. Otherwise, use the numeric keys to enter a new location and then press **ENTER** to save it.

Date: (Date Print Location)

Press the **ENTER** key to show the current setting for the location of date printing. If the setting displayed is acceptable, press the **ENTER** key again to save it. Otherwise, use the numeric keys to enter a new location and then press **ENTER** to save it.

ID: (ID Prompt Print Location)

Press the **ENTER** key to show the current setting for the location of ID prompt printing. If the setting displayed is acceptable, press the **ENTER** key again to save it. Otherwise, use the numeric keys to enter a new location and then press **ENTER** to save it.

Con: (Consecutive Number Print Location)

Press the **ENTER** key to show the current setting for the location of consecutive number printing. If the setting displayed is acceptable, press the **ENTER** key again to save it. Otherwise, use the numeric keys to enter a new location and then press **ENTER** to save it.

Gross: (Gross Weight Print Location)

Press the **ENTER** key to show the current setting for the location of Gross weight printing. If the setting displayed is acceptable, press the **ENTER** key again to save it. Otherwise, use the numeric keys to enter a new location and then press **ENTER** to save it.

Tare: (Tare Weight Print Location)

Press the **ENTER** key to show the current setting for the location of Tare weight printing. If the setting displayed is acceptable, press the **ENTER** key again to save it. Otherwise, use the numeric keys to enter a new location and then press **ENTER** to save it.

SETUP AND CALIBRATION, Cont

nEt : (Net Weight Print Location)

Press the **ENTER** key to show the current setting for the location of Net weight printing. If the setting displayed is acceptable, press the **ENTER** key again to save it. Otherwise, use the numeric keys to enter a new location and then press **ENTER** to save it.

G RLL : (Gross Weight Accumulator Print Location)

Press the **ENTER** key to show the current setting for the location of Gross weight accumulator printing. If the setting displayed is acceptable, press the **ENTER** key again to save it. Otherwise, use the numeric keys to enter a new location and then press **ENTER** to save it.

n RLL : (Net Weight Accumulator Print Location)

Press the **ENTER** key to show the current setting for the location of Net weight accumulator printing. If the setting displayed is acceptable, press the **ENTER** key again to save it. Otherwise, use the numeric keys to enter a new location and then press **ENTER** to save it.

Count : (Count "number of pieces on the scale" Print Location)

Press the **ENTER** key to show the current setting for the location of Count (number of pieces on scale) printing. If the setting displayed is acceptable, press the **ENTER** key again to save it. Otherwise, use the numeric keys to enter a new location and then press **ENTER** to save it.

ERLH : (Piece Weight Print Location)

Press the **ENTER** key to show the current setting for the location of Piece weight printing. If the setting displayed is acceptable, press the **ENTER** key again to save it. Otherwise, use the numeric keys to enter a new location and then press **ENTER** to save it.

CRLF : (Carriage Return Line Feed) - *Data Format Termination*

Data transmitted from the serial I/O port can be terminated with a single carriage return and either no line feed or a single line feed command. Press the **ENTER** key to view the current setting. A "YES" displayed means the data will be terminated with a carriage return AND a line feed. A "no" displayed means the data will be terminated with a single carriage return only.

If the setting displayed is acceptable, press the **ENTER** key again to save it. Otherwise, using the numeric keys, **0/NO** or **1/YES**, enter the new setting and then press the **ENTER** key to save it.

EOP : (End-Of-Print Line Feeds)

At the end of a data transmission to a printer, the indicator can transmit a pre-selected number of line feed commands to space the paper in the printer to the desired position for withdrawal or for the next print.

Press the **ENTER** key to view the current setting. If the displayed value is acceptable, press the **ENTER** key to save it. Otherwise, use the numeric keys to enter the new the number of End-Of-Print linefeeds and then press the **ENTER** key to save the new setting. Allowable values are: 0 through 99.

SETUP AND CALIBRATION, Cont

F5PRn (*F5PRn?*) - Fine Span Adjustment



NOTE! The *F5PRn* and *H i r ES* modes require a load of 10% of Capacity be on the scale before adjustments can be made.

With the *F5PRn?* prompt displayed after pressing the **ENTER** key at the last Print prompt:

With *F5PRn?* displayed, press the **ENTER** key. The display will change to show the current setting "no". To skip the Fine Span Adjustment and return to the *SEtUP* menu, press the **ENTER** key again. To perform the Fine Span Adjustment, place a calibrated test weight on the scale and press the numeric key **1/YES** and then the **ENTER** key.

After pressing the **ENTER** key, the display will change to show the amount of the test weight and the annunciator display will alternately flash off and on i.e. (all ON, weighing unit off, then all OFF, weighing unit ON). Press the **1/YES** to increase the span OR press the **0/NO** key to decrease the span. Press the **0** key to return to the previous prompt or press the **ENTER** key to exit *F5PRn?* and return to the *SEtUP* menu.

With the *F5PRn* prompt displayed after pressing the Calibration switch:

With *F5PRn* displayed, place a calibrated test weight on the scale and press the **ENTER** key. After pressing the **ENTER** key, the display will change to show the amount of the test weight and the annunciator display will alternately flash off and on (all ON, weighing unit off, then all OFF, weighing unit ON). Press the **1/YES** to increase the span OR press the **0/NO** key to decrease the span. Press the **0** key to return to the previous prompt or press the **ENTER** key to exit *F5PRn* and return to the *SEtUP* menu.

H i r ES - Display High Resolution Weight

With *H i r ES* on the display, pressing the **ENTER** key will show the active weight in "high resolution" mode (in 1/10 interval). Press the **PRINT** key to print the weight (followed by the text TEST) via the selected printer output port enabled during setup and calibration.

LoCoUt - Key Lock Out Function

With *LoCoUt* on the display, pressing *any* key will display "LoCd" (locked) or "UnLoCd" (unlocked) for the current key state. Pressing a locked key during normal operation will result in a 1/2 second display "LoCd" and the key will be ignored. To exit the *LoCoUt* function, press the calibration switch or cycle power (press the **ON/OFF** key twice).



NOTE! The menu selections *H i r ES* and *LoCoUt* can only be selected using the calibration switch.

SETUP REVIEW

The 210-FE indicator allows several operational parameters to be reviewed and changed without breaking the calibration seal. These operational parameters are:

- Power Up Zero Reset Enable/Disable
- Time Format
- Digital Output Control Enable/Disable
- Sleep Mode Feature Enable/Disable
- Auto Shutoff Feature Enable/Disable

Serial Input / Output Configuration

- Baud Rate
- Parity
- Number of Data Bits
- Number of Stop Bits
- Continuous Output Port 1
 - Continuous Output Format
- Continuous Output Port 2
 - Continuous Output Format

Print Tab Settings

- Printer Port Selection
- Time
- Date
- Consecutive Number
- Gross Weight
- Tare Weight
- Net Weight
- Gross Weight Accumulator
- Net Weight Accumulator
- Count
- Piece Weight

To enable the Setup Review feature, with the indicator ON:

1. Press the **⊖** key. The indicator will respond by showing the *Funct =* (Function) prompt and alternately flashing off and on (all ON, weighing unit off, then all OFF, weighing unit ON) the annunciator display.
2. Press the **ZERO/REVIEW** key. The display will change to the prompt for the selection of power-up zeroing (*PUZ =*).
3. Using the same procedure as described in the Setup and Calibration section of this manual, make the required changes.
4. Press the **⊖** key to return to the previous prompt.
5. To exit Setup Review, press the **ENTER** key to step the remaining prompts *OR* at anytime, cycle the power (press the **ON/OFF** key twice).

CALIBRATION “C” NUMBERS

The “C” numbers are displayed only during the Test mode operation by pressing the **⊖** key and then the **UNITS/TEST** key. The “C” numbers are shown at the end of the test operation and each number is displayed for approximately 4 seconds, allowing you to record them. Each number may be up to three (3) digits in length. By recording these numbers you will be able to return the indicator to its present calibration settings without using test weights simply by entering the “C” numbers. *Refer to the Setup and Calibration, “ℓℓℓ” section of this manual for instructions on using the “C” numbers.*



If any components have been changed that affect calibration and/or your scale is used in a commercial application and must be "Legal for Trade" you can not use "C" numbers to re-calibrate.

ACCUMULATORS

To *view* the NET accumulator:

1. Press the **⊖** key and then the **NET/GROSS** key.
2. Press the **⊖** key to return to normal operation.

To *print* the NET accumulator:

1. Press the **⊖** key, the **NET/GROSS** key and then the **PRINT** key
2. The indicator will return to normal operation when printing has been completed.

To *clear (zero)* the NET accumulator:

1. Press the **⊖** key, the **NET/GROSS** key and then the **ZERO** key
2. Press the **⊖** key to return to normal operation.

To *view* the Gross accumulator:

1. Press the **⊖** key and then the **NET/GROSS** key twice.
2. Press the **⊖** key to return to normal operation.

To *print* the Gross accumulator:

1. Press the **⊖** key, the **NET/GROSS** key twice and then the **PRINT** key
2. The indicator will return to normal operation when printing has been completed.

To *clear (zero)* the Gross accumulator:

1. Press the **⊖** key, the **NET/GROSS** key twice and then the **ZERO** key
2. Press the **⊖** key to return to normal operation.

To *view* the Count accumulator:

1. Press the **⊖** key and then the **COUNT/SAMPLE** key.
2. Press the **⊖** key to return to normal operation.

To *print* the Count accumulator:

1. Press the **⊖** key, the **COUNT/SAMPLE** key and then the **PRINT** key
2. The indicator will return to normal operation when printing has been completed.

To *clear (zero)* the Count accumulator:

1. Press the **⊖** key, the **COUNT/SAMPLE** key and then the **ZERO** key
2. Press the **⊖** key to return to normal operation.

TROUBLESHOOTING

Error Codes

The 210-FE indicator is equipped with software that indicates when an error in the operation takes place. The following lists the error codes displayed by the 210-FE along with their meaning. Should you encounter an error code, please refer to this list for the cause.

Calibration (Calibration Button)

Calibration will be displayed (until the condition changes), on power-up if the calibration switch is pressed in by the operator, the calibration access screw is the wrong length and is depressing the switch, the switch is disconnected from the PC board, or the switch is defective.

CORRECTIVE ACTION: Release the switch. Insure correct screw (#10 x ½ Stainless Steel fillister head) was installed for the calibration access screw. Referring to Figure No. 9, make sure calibration switch cable is plugged into P7 on the PC board. Replace calibration switch assembly. Consult your scale service provider.

Config (Configuration)

E²PROM checksum failure. Indicates improper stored calibration data, calibration is necessary.

CORRECTIVE ACTION: Recalibrate with calibrated test weight.

Error

An invalid keypad entry was attempted:

- A. **PRINT** key pressed with a negative weight.
- B. **TARE** key pressed to enter a push button tare value of a negative value.
- C. **ENTER** key pressed to enter a tare weight value that exceeds the scale capacity.
- D. **ENTER** key pressed to enter a tare weight value that is inconsistent with the scale division value (i.e. attempt to enter a tare of 123 with scale divisions of 5).
- E. **ZERO** key pressed when the gross weight is outside the scale zero weight range.
- F. **lb/kg** key pressed to change to kg when the kg tare weight value exceeds 4 digits in length.

CORRECTIVE ACTION: Determine which of the reasons for the error display is applicable and take the appropriate corrective action.

ErrorH (Analog Error High)

1. The load cell input is above the range of the indicator.

CORRECTIVE ACTION: Check for improper load cell wiring, excessive load, and for output of 1 to 40mV.

2. Load cell or circuit failure.

CORRECTIVE ACTION: Consult your scale service provider.

ErrorL (Analog Error Low)

1. The load cell input is below the range of the indicator.

CORRECTIVE ACTION: Check for improper load cell wiring and for output of 1 to 40mV.

2. Load cell or circuit failure.

CORRECTIVE ACTION: Consult your scale service provider.

Error

A program checksum mismatch has been detected.

CORRECTIVE ACTION: Consult your scale service provider.

Error

Internal RAM failure.

CORRECTIVE ACTION: Consult your scale service provider.

TROUBLESHOOTING, Cont.

Error Codes, Cont.

H U H P

UNITS key pressed in an attempt to perform a “unit” conversion that is not allowed.

CORRECTIVE ACTION: Determine the reason for the error display and take the appropriate corrective action.

n o t A r E

NET key pressed with no stored tare weight value.

CORRECTIVE ACTION: Determine the reason for the error display and take the appropriate corrective action.

O C A P (Over Capacity)

The load on the scale exceeds the scale capacity plus nine (9) divisions.

CORRECTIVE ACTION: Remove the over capacity load from the scale platform. May indicate miscalibration.

- o F - (Overflow)

The indicator is attempting to display a positive number greater than six (6) digits in length or a negative number of more than five (5) digits.

CORRECTIVE ACTION: Return to Gross Weight mode and review Tare value. May indicate miscalibration.

t o o b i U

UNITS key pressed in an attempt to perform a “unit” conversion where the interval would have been greater than 50.

CORRECTIVE ACTION: Determine the reason for the error display and take the appropriate corrective action.

U n S t b (Unstable)

Motion is present when trying to power up, print, zero or perform a push button tare function.

CORRECTIVE ACTION: Wait for a stable weight display (*STABLE* annunciator on) before performing any of these operations.

TROUBLESHOOTING, Cont.

Before You Call Service

The 210-FE indicator has been designed to provide you with years of trouble-free operation. However, should you experience a problem, please refer to the troubleshooting guide below before you call for service. The following describes several types of symptoms along with suggested remedies.

PROBLEM	POSSIBLE SOLUTIONS
Display does not turn on	AC operation: Is the AC power cord fully inserted into the wall receptacle? Check wall receptacle for proper AC power. Try another electrical appliance in the same receptacle, does it work? Check the circuit breaker. Has there been power failure?
Incorrect weight displayed	Has the instrument been calibrated? Insure that the scale platform isn't touching an adjacent object. Check the load cell connector wiring. If using four (4) wire load cells, insure the sense lead jumpers (J4 & J5) are installed. Have proper operation procedures been followed?
Indicator will not display weight	Refer to Error Codes section and make certain that the "oLAP" message is not displayed. If so, and scale is not loaded, perform the calibration sequence.
The printer prints but does not use the Print Tab Settings or prints a test ticket	The print tab setting or visual ticket format must be selected prior to beginning the weighing operation or just prior to printing the ticket. To select the ticket format prior to beginning the weighing operation: <ol style="list-style-type: none">1. Press the ⊕ key and then the PRINT key. The display will change to the <i>P-r-t-</i>.2. Press the ENTER key to show the current value.3. If the value displayed is acceptable, press the ENTER key again to save it.4. If the displayed value is incorrect (or another ticket format is desired), use the numeric keys to enter the new value and then press the ENTER key to save it. To select the ticket format just prior to printing the ticket: <ol style="list-style-type: none">1. Press the desired format number.2. Pressing the PRINT key. Allowable values for ticket formats are: <ul style="list-style-type: none">0 = print tab settings1 = visual ticket format 12 = visual ticket format 2 NOTE! When a print format is selected (by either method), it will remain active until changed by the operator.

CALIBRATION SEAL INSTALLATION

If your 210-FE Weight Indicating Instrument is used in a commercial application it must be tested and sealed by your local weights and measurements official. The 210-FE has been designed to accept a lead and wire security seal to prevent unauthorized access to the calibration adjustments. Refer to Figure No. 14 for details on the installation of the seal.

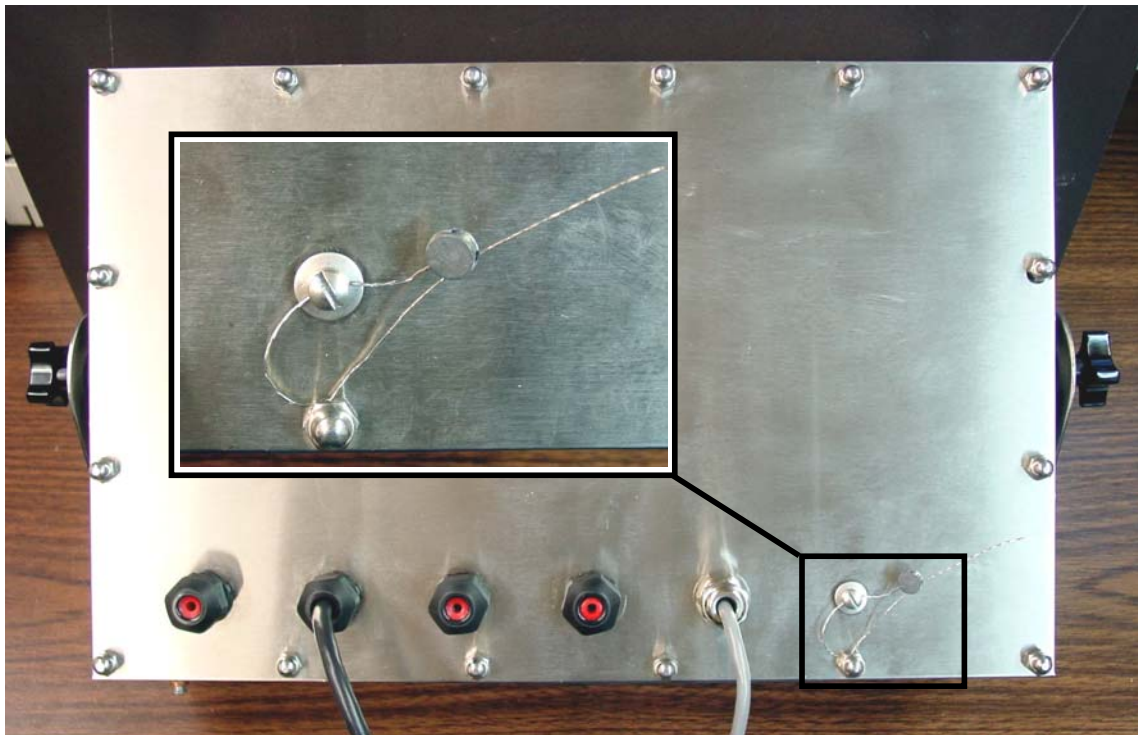
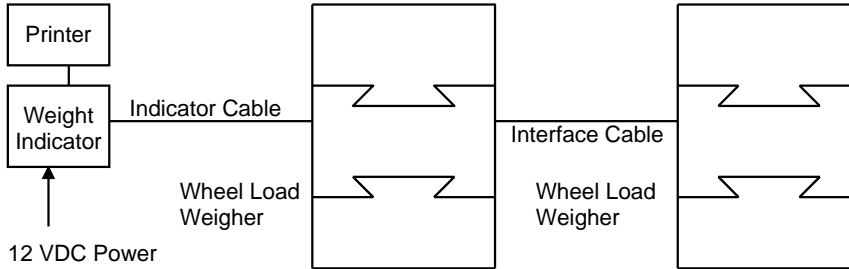

Figure No. 14

AXLE WEIGHER MODE OPERATION

After placing the wheel load weighers on the ground in front of the vehicle(s) to be weighed, the two weighers are connected together using the interconnection cable assembly. One weigher (makes no difference which) is connected to the indicator using the indicator interface cable. The interconnection diagram is shown below:



1. With power applied to the indicator, press the **ON** key to turn on the indicator.
2. Verify that the weight display is at zero (`00`). If not, press the **ZERO** key.
3. Have the vehicle driven forward until the first axle is on the center of the wheel load weighers.
4. Observe the weight of the first axle and press the **PRINT** key to record the weight, date and time.
5. Have the vehicle pull forward until the next axle is on the center of the wheel load weighers. **NOTE!** If the next axle is a tandem or tridem set of axles, place **ONLY** the first axle of the group on the wheel load weighers.
6. Observe the weight of this axle and press the **PRINT** key to record the weight, date and time.
7. Repeat step 5 until all of the remaining axles have been weighed and printed.
8. After the last axle has been weighed and its value recorded, pull the vehicle off the wheel load weighers.
9. Press the ***** key and then press the **PRINT** key. The total of all of the vehicle axle weights will be recorded and printed. The example below illustrates a typical print ticket for a five-axle truck.

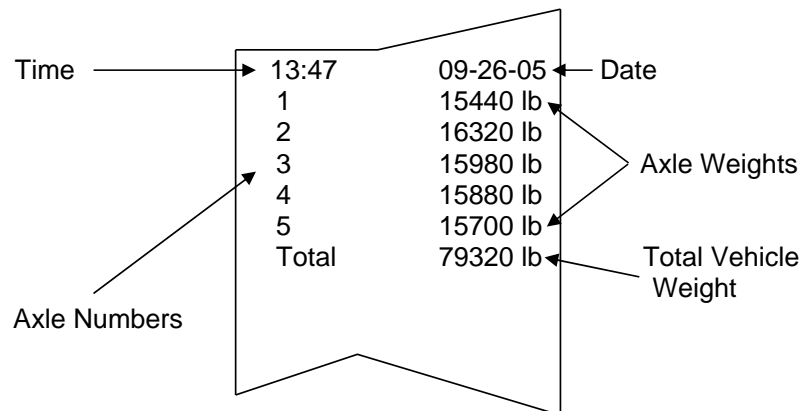

AXLE WEIGHER MODE OPERATION, Cont.

Additional Features

If you wish to also record the total of any axle groups, press the number key corresponding to the number of axles in the axle group to be totaled when the first axle in the group is weighed. After the last axle in the group is recorded, the printer will automatically record the subtotal of the axle group weights. In the previous example, assume that axles 2 and 3 form a tandem pair of axles as do axles 4 and 5. To record the total weight of these axle groups, press the number **2** key followed by the **PRINT** key when printing axles 2 and 4. This indicates that the next two axles form an axle group whose total is to be recorded. The example below illustrates the print format when the two axle groups are identified.

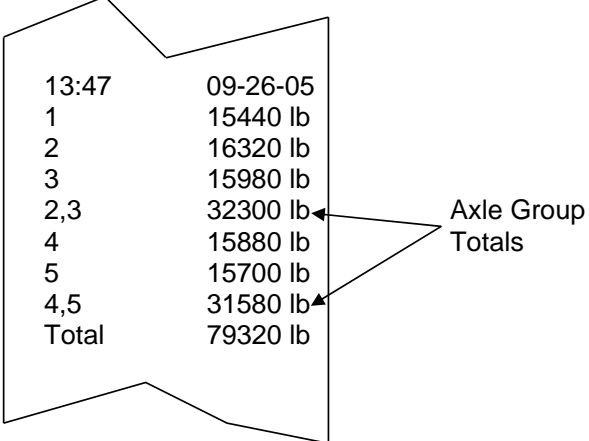

13:47	09-26-05
1	15440 lb
2	16320 lb
3	15980 lb
2,3	32300 lb
4	15880 lb
5	15700 lb
4,5	31580 lb
Total	79320 lb

Note that there is a maximum of 9 single axles in an axle group and that the axles must be weighed in a consecutive group. The axles comprising the axle group are also identified on the printed record.

If you wish to print additional copies of the printed record for the vehicle, press the * key again followed by the **PRINT** key and a summary print will be produced. This can be repeated as often as necessary to secure the number of desired copies. Note, however, that as soon as the first axle of the next vehicle is printed, the weights from the previously weighed vehicle are cleared.

PART IDENTIFICATION

(Final Assembly)

ITEM NO.	QTY.	PART NUMBER	DESCRIPTION
1	1	8200-D296-0A	SUB ASSEMBLY: FRONT ENCLOSURE
2	1	8200-D295-0A	SUB ASSEMBLY: REAR ENCLOSURE
3	15	6013-0433	NUT #10-32 HEX ACORN LOCK SS
4	1	8200-B026-08	NUT #10-32 HEX ACORN, DRILLED, S.S.
6	1	593GR986	SERIAL TAG ASSY

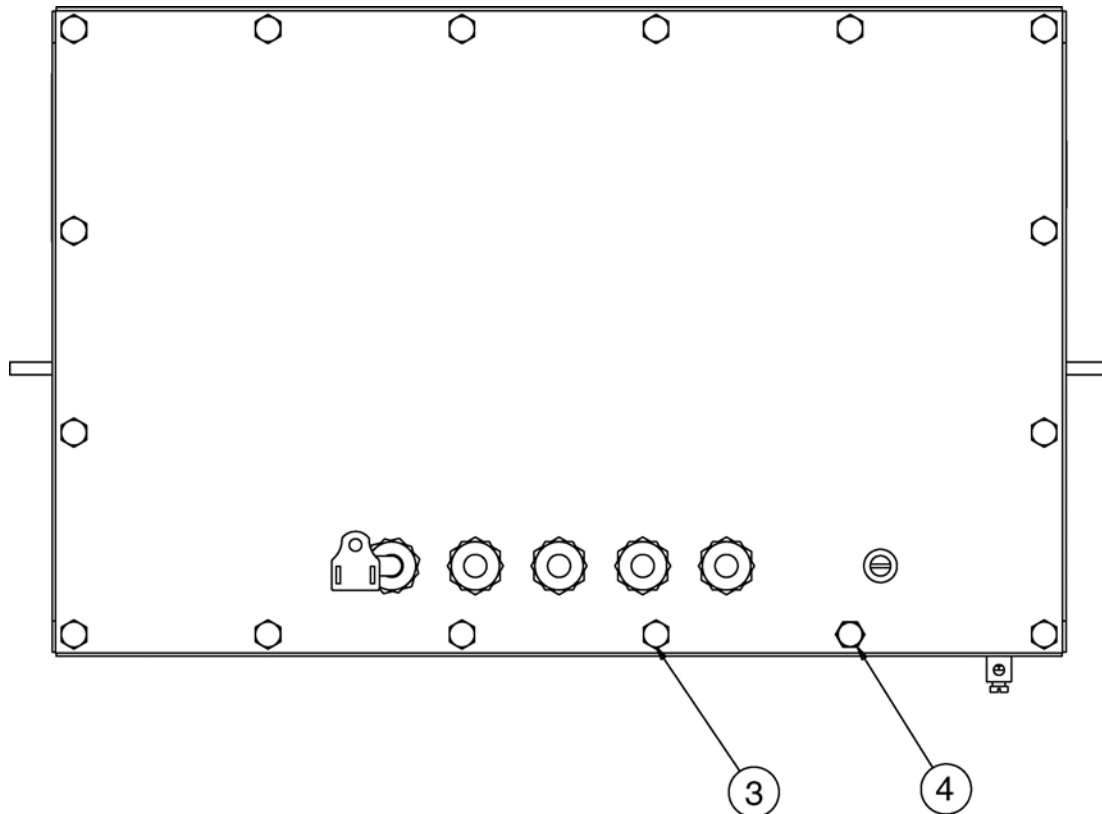
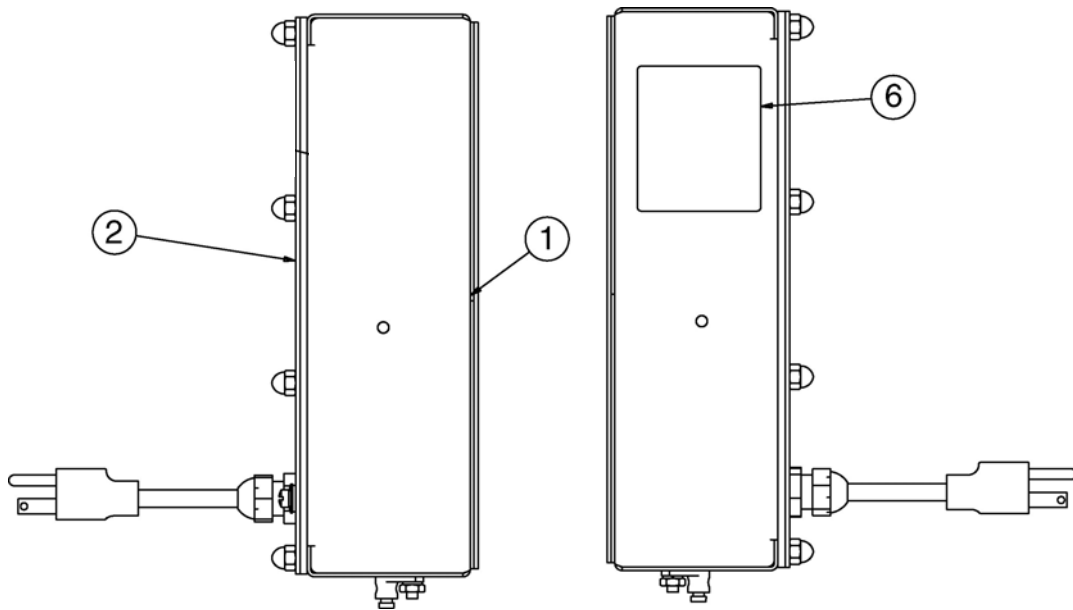

PART IDENTIFICATION, Cont

(Front Enclosure Sub Assembly)

ITEM NO.	QTY.	PART NUMBER	DESCRIPTION
1	28	6013-0039	NUT #6-32 HEX
2	1	6013-0297	NUT #10-32 HEX
3	2	6021-0663	SCW PAN-HEAD.. MACHINE-SCW 06-32X.187
4	1	6024-0037	WASHER LOCK HELICAL SP #10 REG SS
5	19	6024-1078	WASHER FLAT #6 NEOPRENE BACKING SS
6	1	6610-5002	GROUND LUG L-35
7	2	6610-5007	CABLE CLIP, 1" X 1" GREY
8	11	6680-0004	WASHER LOCK INT TOOTH #6 TYPE A Z-PL
9	7	6680-0121	SPACER #6 X .437 NYLON
10	2	6680-0218	SPACER #6 X 1.125 NYLON
11	1	8200-B241-0A	CABLE: 210-FE IIC
12	1	8200-B294-08	GASKET, 210FE
13	1	8200-C289-0A	WELDMENT: BEZEL FOR 210FE
14	1	8200-C299-08	BOARD MOUNT BRACKET
15	1	8200-D201-1A	PCB ASSEMBLY - 210 CONTROLLER
16	1	8200-D278-0A	PCB ASSY: DISPLAY BOARD, 210-FE
17	1	8200-D286-08	OVERLAY: 210-FE
18	1	8200-D287-08	KEYPAD: 210-FE
19	1	8200-D293-0A	WELDMENT: ENCLOSURE, FRONT

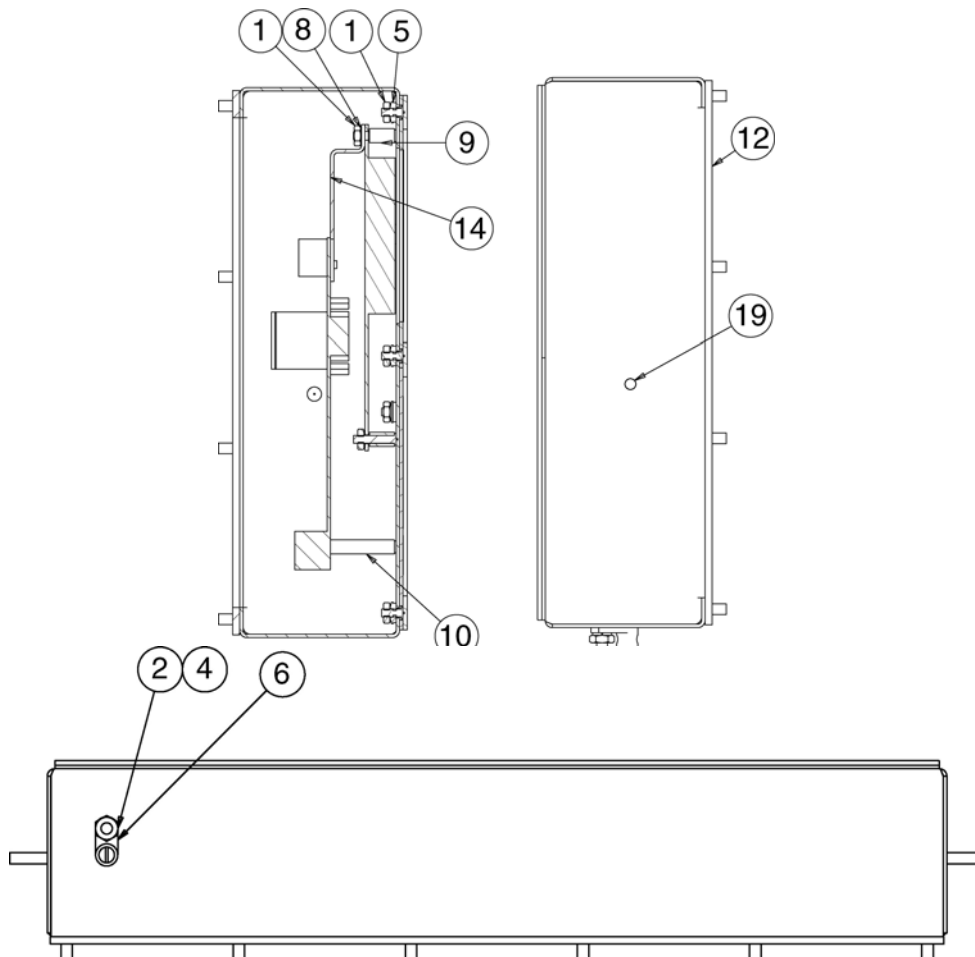

PART IDENTIFICATION, Cont

(Front Enclosure Sub Assembly)

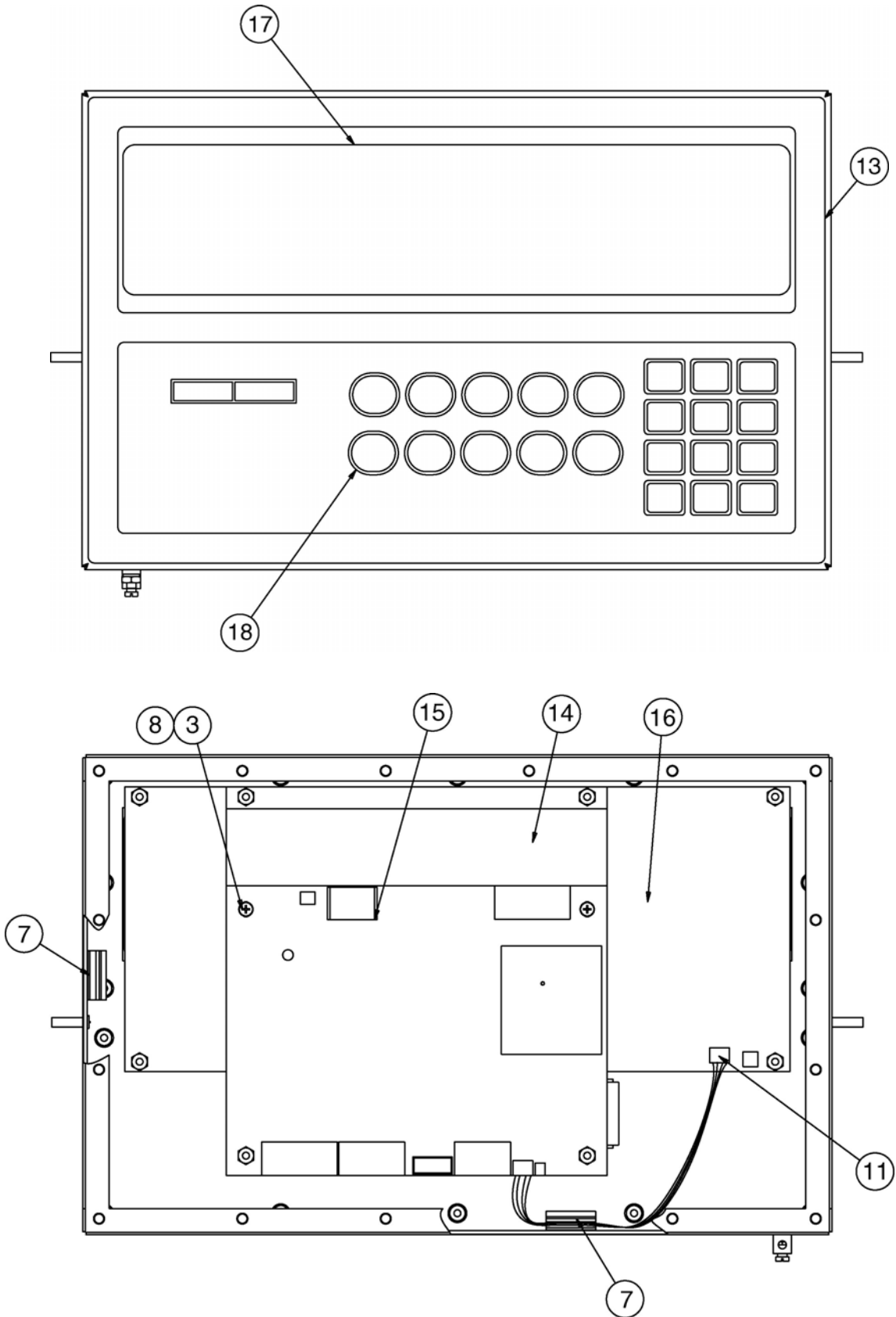

PART IDENTIFICATION, Cont

(Rear Enclosure Sub Assembly)

ITEM NO.	QTY.	PART NUMBER	DESCRIPTION
1	5	6013-0315	NUT #6-32 HEX SMALL PATTERN Z/P
2	1	6021-1108	SCW FILLISTER. MACHINE-SCW 10-32X.375
3	1	6024-1081	WASHER FLAT #10 NEOPRENE BACKING SS
4	4	6540-1104	PLUG, HOLE 0.173"-0.240" RED POLYETH
5	1	6610-1506	CONN GLAND .160-.310 GRIP .60 MTG NICKEL
6	4	6610-2248	CONN GLAND .187-.312 GRIP .599 MTG BLK
7	1	6610-5007	CABLE CLIP, 1" X 1" GREY
8	5	6680-0004	WASHER LOCK INT TOOTH #6 TYPE A Z-PL
9	4	6680-0138	SPACER #6 X .187 NYLON
10	4	6680-1107	SPACER #4-40 X .750 3/16 HEX ALU. Z/P
11	2	6680-2105	SPACER #4-40 X .750 NYLON
12	1	6800-1051	POWER SUPPLY 15V/4A OPEN FRAME 90-264VAC
13	3	6980-0014	CABLE TIE 4" WHITE
14	1	6980-1030	POWER CORD 18/3 SVT CEE 6.3FT
15	1	8200-B019-08	BRACKET: CALIBRATION SWITCH - 210
16	1	8200-B104-08	LABEL: 205/210 TERM. BLOCK
17	1	8200-B212-0A	CABLE: GROUND 205/210
18	1	8200-B237-0A	CABLE: AC POWER W/FILTER 205/210 DWI
19	1	8200-B240-0A	CABLE 210-FE POWER SUPPLY OUTPUT
20	1	8200-C291-0A	REAR PANEL WELDMENT
21	1	8200-C363-08	POWER SUPPLY COVER
22	1	8510-C346-OI	LABEL CAUTION HIGH VOLTAGE
23	1	8539-B254-0A	CABLE ASSEMBLY: CAL SWITCH

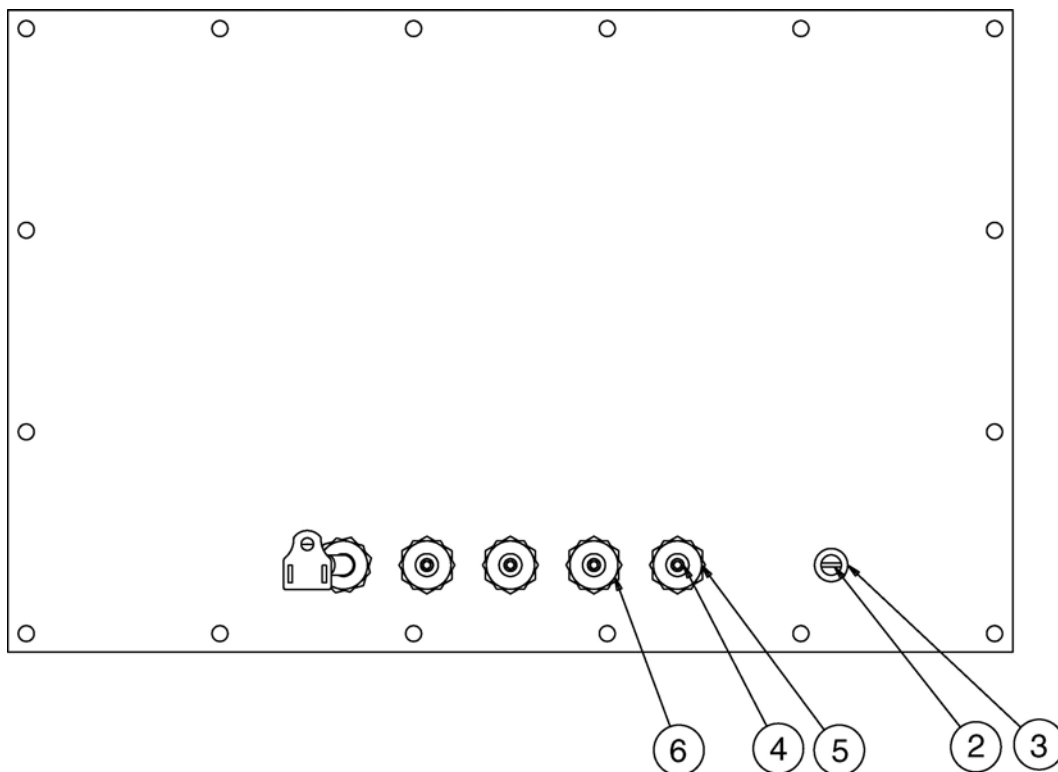

PART IDENTIFICATION, Cont

(Rear Enclosure Sub Assembly)

