

GSE Model 350/355 I.S.

INTRINSICALLY SAFE INDICATOR



Technical Reference Manual

Version 3.0



GSE Model 350/355 I.S.

Technical Reference Manual

Version 3.0

GSE Model 350 I.S. and Model 355 I.S. Intrinsically Safe Technical Reference Manual

Copyright © 2005 GSE Scale Systems. All rights reserved.

Published by:

GSE Scale Systems
42860 Nine Mile Road
Novi, MI 48375
USA

Information in this *Operation Manual* is subject to change *without notice* due to correction or enhancement. The information described in this manual is solely the property of GSE. No part of this manual may be reproduced or transmitted in any form or by any means, electronic or mechanical, including photocopying and recording and sold for any monetary figure without the express written permission of GSE.

GSE Locations

GSE Scale Systems

42860 Nine Mile Road
Novi, MI 48375
U.S.A.
Phone: (800) 755-7875
www.gse-inc.com

GSE Canada, Inc.

617 East Lake Road
Airdrie, Alberta Canada T4B 2B8
Phone: (403) 948-9921
Fax: (403) 948-1449

SPX GSE Amprobe Europe GmbH

Phone: +49 (0) 2161-59906-11
Fax: +49 (0) 2161-59906-20

Table of Contents

Chapter 1: Introduction	1
Hazardous Area Guidelines	2
Hazard Grouping.....	2
Duration of Hazard.....	2
Temperature Codes	2
Definitions	4
Entity Evaluation Concept.....	4
Entity Rating Definitions	5
Entity Ratings.....	5
Factory Mutual Approval	6
NEMKO Approval (ATEX)	7
CSA Approval	8
Standard Functions	9
Standard Features	9
Specifications	9
Display	10
LED Display	10
LCD Display.....	10
Annunciators	10
350 I.S. KEYPAD	11
Secondary Functions	11
355 I.S. Keypad	12
Weigh Mode Functions	14
Entering a Tare Value (Model 350)	14
Entering a Tare Value (Model 355)	14
Chapter 2: Installation	15
System Diagrams	16
Outline Drawings	16
Load Cell Connections	17
Communication Port Connections	18
Remote Key Connections	18
Remote Display Connections	19
Hazardous Area Options	19
Battery Power Supply (External)	19
AC To DC Power Supply (External)	20
AC To DC Power Supply Extension Cable	20
5 Volt And 8 Volt Excitation.....	20
Fiber-Optic Interface.....	20

Safe Area Options	21
Safe Area Hub Kit.....	21
Safe Area Analog Option Installation.....	26
Chapter 3: Configuration	31
Entering the Setup Mode (Model 350 I.S.)	32
Entering the Setup Mode (Model 355 I.S.)	33
Selecting a Parameter.....	33
Changing a Parameter Value	34
Selection Parameters	34
Key-In Parameters.....	35
Saving Parameters	36
Factory Default.....	38
List of Parameters	39
Parameter Map Details	41
Preset Transmit Selections	48
ID Number Entry and Printing	49
Custom Transmit	50
Elements Of A Custom Transmit.....	50
Writing A Custom Transmit ASCII Text File	51
Access Setup And Clearing Existing Custom Transmit	51
Entering ASCII Text	51
Entering ASCII Control Codes	51
Parameter Selection Numbers	53
Exiting Setup Mode And Saving Changes.....	54
Parts Counting	54
Setpoint Setup.....	55
Activation Methods (General)	56
Pre-Acts (General)	57
Learn Feature (General).....	57
Pause Feature (General).....	57
Changing Targets From The Weigh Mode (General)	58
Change Target Weight Example (General).....	58
Bargraph Setup (LCD)	59
Scaling For "Bars" (Bargraph Arrows).....	59
Percentage Check-Weighing	62
Setpoint Activation (Percentage Check-Weighing).....	62
Changing Targets From The Weigh Mode (Percentage Check-Weighing).....	62
Example (Percentage Check-Weighing)	63
Fill.....	63
Activation Method (Fill)	64
Pre-Acts (Fill)	64
Learn Feature (Fill)	64
Pause Feature (Fill)	65

Changing Targets From The Weigh Mode (Fill)	65
Example (Fill)	65
Batch.....	65
Activation Method (Batch)	66
Pre-Acts (Batch).....	66
Learn Feature (Batch)	66
Pause Feature (Batch)	66
Changing Targets From The Weigh Mode (Batch)	66
Example (Batch)	67
Discharge.....	67
Activation Method (Discharge)	68
Pre-Acts (Discharge).....	68
Learn Feature (Discharge)	68
Pause Feature (Discharge)	68
Changing Targets From The Weigh Mode (Discharge)	69
Example (Discharge).....	69
Both	69
Activation Method (Both)	70
Pre-Acts (Both)	70
Learn Feature (Both)	70
Pause Feature (Both)	70
Changing Targets From The Weigh Mode (Both).....	71
Example (Both).....	71
Absolute Check-Weighing	71
Setpoint Activation (Absolute Check-Weighing).....	72
Changing Targets From The Weigh Mode (Absolute Check-Weighing).....	72
Example (Absolute Check-Weighing).....	73
Independent Setpoint Operation	73
Setpoint Activation (Independent).....	74
Changing Targets From The Weigh Mode (Independent).....	74
Example (Independent).....	75
Target Deviation Check-Weighing	75
Setpoint Activation (Target Deviation Check-Weighing)	75
Changing Targets From The Weigh Mode (Target Deviation Check-Weighing)	76
Example (Target Deviation Check-Weighing)	77
Time and Date Setup (Model 350 I.S.)	77
Time and Date Setup (Model 355 I.S.)	79
Remote Key Configuration	80
Upgrade Indicator Firmware	80
Prepare For Upgrade	81
Load Flash File	81
Analog Output Setup	82
Analog Output Calibration.....	82
Entering Analog Calibration Values.....	83
Analog Output Example	84

Remote Display Configuration	84
Master To Remote (Slave) Configuration.....	84
Setup Master Indicator.....	85
Setup Remote Indicator.....	85
Control (Hazardous Area) to Hub (Safe Area) Configuration.....	89
300 Series Command Codes.....	90
Display Capture Utility.....	91
Chapter 4: Calibration.....	93
Setup Mode Calibration	94
Fast Calibration	94
Performing Calibration.....	94
Establishing Zero	94
First Zero.....	95
Last Zero	96
False Zero.....	98
Only Zero	100
Reset Calibration.....	101
Multi-Point Linerization	103
First Zero?	103
Reset Cal.....	103
Examining Calibration Results	104
Establishing A Span.....	104
Exiting Calibration	105
Chapter 5: Legal For Trade.....	107
NTEP Requirements	108
OMIL Requirements	108
Other Requirements	108
Sealing And Audit Trails.....	109
Physical Seal.....	109
Audit Trails	110
OIML Audit Trail.....	110
Calibration Audit Trail.....	110
Setup Audit Trail.....	110
Viewing Audit Trail Parameters	110
Chapter 6: Troubleshooting.....	113
Error Messages.....	114
Operational Errors.....	114
Setup Mode Errors	114
Hardware Errors	115
Calibration Errors.....	115
Communication Errors	115
Miscellaneous Errors.....	115

Viewing Setup	116
Information Mode Parameters	116
A/D Calibration Procedure	118
<i>Appendix A: Maintenance</i>	<i>121</i>
Main Board Replacement	122
Main Board Removal.....	122
Main Board Installation	122
Keypad Replacement	122
Model 350 I.S. Keypad Removal.....	122
Model 355 I.S Keypad Removal.....	122
Model 350 I.S. Keypad Installation.....	123
Model 355 I.S. Keypad Installation.....	123
Display Replacement	123
Display Removal.....	123
Display Installation.....	124
<i>Appendix B: Label Drawings</i>	<i>125</i>
<i>Appendix C: Control Drawings</i>	<i>135</i>

Chapter 1: Introduction

Thank you for selecting the GSE Model 350/355 Intrinsically Safe Indicator. The Model 350 I.S. and Model 355 I.S. continue the GSE tradition of *Excellence in Weighing*. A properly installed and maintained Model 350 I.S. or Model 355 I.S. will provide many years of reliable, accurate performance.

The chapters of this manual focus on various aspects of the Model 350/355 I.S.:

Chapter 1:	Introduction	Hazardous Area Guidelines, Features and Specifications.
Chapter 2:	Installation	Installation of Indicator and Options.
Chapter 3:	Configuration	Setup the Model 350/355 I.S. to a specific application.
Chapter 4:	Operation	Using the Model 350/355 I.S.
Chapter 5:	Calibration	Calibrate the indicator to a scale .
Chapter 6:	Troubleshooting	Troubleshooting help and error messages.
Appendix A:	Maintenance	Main board, display and keypad replacement
Appendix B:	Label Drawings	Drawings of the different approval labels used
Appendix C:	Control Drawings	System drawings

Hazardous Area Guidelines

The GSE Models 350 I.S. and 355 I.S. instruments are approved by FM Approvals as intrinsically safe for use in hazardous areas. An intrinsically safe device has been proven through calculation and testing that it cannot produce enough electric or thermal energy under normal or fault conditions to cause ignition of flammable material present in the atmosphere. The hazardous area is defined in terms of how long the hazard is present, how easily it is ignited, and what maximum temperature can be present.

Hazard Grouping

	Gas/Dust/Fiber	US (NEC 505) IEC/CENELEC	US (NEC500)
Gases	Acetylene	Group IIC	Class I/Group A
	Hydrogen	(Group IIB + H ₂)	Class I/Group B
	Ethylene	Group IIB	Class I/Group C
	Propane	Group IIA	Class I/Group D
	Methane	Group I *	Mining *
Dusts	Metal Dust	None	Class II/Group E
	Coal Dust	None	Class II/Group F
	Grain Dust	None	Class II/Group G
	Fibers	None	Class III

* Not within scope of NEC

Duration of Hazard

	Flammable material present continuously	Flammable material present intermittently	Flammable material present abnormally
IEC/CENELEC	Zone 0	Zone 1	Zone 2
US (NEC 505)	Zone 0	Zone 1	Zone 2
US (NEC 500)	Division 1		Division 2

Temperature Codes

Max. Surface Temp.	US (NEC 505) IEC/CENELEC	US (NEC 500)
450°C	T1	T1
300°C	T2	T2
280°C		T2A
260°C		T2B
230°C		T2C
215°C		T2D
200°C	T3	T3
180°C		T3A
165°C		T3B
160°C		T3C
135°C	T4	T4
120°C		T4A
100°C	T5	T5
85°C	T6	T6

Class I, Division 1, Groups A, B, C & D

Class I, Division 1 locations are those in which hazardous concentrations of flammable gases or vapors exist continuously, intermittently or periodically under normal operating conditions. Electrical equipment for use in such locations may be “explosion proof,” “intrinsically safe,” “purged” or otherwise protected to meet the intent of Articles 500 of the National Electrical Code®.

Explosion proof protection consists of equipment designed to be capable of containing an internal explosion of a specified flammable vapor-air mixture. In addition, the equipment must operate at a safe temperature with respect to the surrounding atmosphere.

Intrinsically safe electrical equipment and associated wiring are incapable of releasing sufficient electrical or thermal energy to cause ignition of a specific hazardous material under “normal” or “fault” operating conditions. Normal operation assumes maximum supply voltage and rated environmental extremes; fault conditions assume any single or dual independent electrical faults plus field wiring open, shorts or connections to ground. Equipment rated as intrinsically safe is recognized by Article 500 as safe for use in hazardous locations without special enclosures or physical protection that would otherwise be required.

Purged systems have fresh air or an inert gas under positive pressure to exclude ignitable quantities of flammables from the electrical equipment enclosure.

Equipment Approved for Division 1 locations shall be permitted in Division 2 locations of the same class, group and temperature class.

Class I, Division 2, Groups A, B, C & D

Class I, Division 2 locations are those in which hazardous concentrations of flammables exist only under unlikely conditions of operation. As such, equipment and associated wiring which are incapable of releasing sufficient electrical and thermal energy to ignite flammable gases or vapors under “normal” operation and environmental conditions are safe to use in Class I, Division 2 locations.

Class I, Zone 0, Groups IIC, IIB & IIA

A Class I, Zone 0 location is a location (1) in which ignitable concentrations of flammable gases or vapors are present continuously; or (2) in which ignitable concentrations of flammable gases or vapors are present for long periods of time. Electrical apparatus for use in such locations may be type of protection “ia” Intrinsic Safety.

Class I, Zone 1, Groups IIC, IIB & IIA

A Class I, Zone 1 location is a location (1) in which ignitable concentrations of flammable gases or vapors are likely to exist under normal operating conditions; or (2) in which ignitable concentrations of flammable gases or vapors may exist frequently because of repair or maintenance operations or because of leakage; or (3) in which equipment is operated or processes are carried on, of such a nature that equipment breakdown or faulty operations could result in the release of ignitable concentrations of flammable gases or vapors and also cause simultaneous failure of electrical equipment in a mode to cause the electrical equipment to become a source of ignition; or (4) that is adjacent to a Class I, Zone 0 location from which ignitable concentrations of vapors could be communicated, unless communication is prevented by adequate positive-pressure ventilation from a source of clean air and effective safeguards against ventilation failure are provided. Electrical apparatus for use in such locations may be type of protection “d” Flameproof, “e” Increased Safety, “ib” Intrinsic Safety, “m” Encapsulation, “o” Oil Immersion, “p” Pressurized or “q” Powder-Filled.

Note: Electrical apparatus Approved for use in Class I, Zone 0 locations shall be permitted in Class I, Zone 1 locations of the same gas group and temperature class.

Class I, Zone 2, Groups IIC, IIB & IIA

A Class I, Zone 2 location is a location (1) in which ignitable concentrations of flammable gases or vapors are not likely to occur in normal operation and if they do occur will exist only for a short period; or (2) in which volatile flammable liquids, flammable gases or flammable vapors are handled, processed or used, but in which the liquids, gases or vapors normally are confined within closed containers or closed systems from which they can escape only as a result of accidental rupture or breakdown of the containers or system or as the result of the

abnormal operation of the equipment with which the liquids or gases are handled, processed or used; or (3) in which ignitable concentrations of flammable gases or vapors normally are prevented by positive mechanical ventilation, but which may become hazardous as the result of failure or abnormal operation of the ventilation equipment; or (4) that is adjacent to a Class I, Zone 1 location, from which ignitable concentrations of flammable gases or vapors could be communicated, unless such communication is prevented by adequate positive-pressure ventilation from a source of clean air and effective safeguards against ventilation failure are provided. Electrical apparatus for use in such locations may be type of protection “nA” Non-Sparking, “nC” Protected contacts, “nR” Restricted Breathing or “p” Pressurized.

Note: Electrical apparatus Approved for use in Class I, Zone 0 or Zone 1 locations shall be permitted in Class I, Zone 2 locations of the same gas group and temperature class.

Class II, Divisions 1 & 2, Groups E, F & G

Electrical equipment suitable for use in Class II locations, as defined by the National Electrical Code[®], is constructed to exclude ignitable amounts of dust from the equipment enclosure. Approved equipment of this type has also been evaluated to assure that hazardous surface temperatures do not exist. Equipment listed as suitable for Class II locations is “dust-ignitionproof” or otherwise designed to meet the intent of Articles 500 and 502 of the National Electrical Code[®].

Class III, Divisions 1 & 2

Class III locations are those which are hazardous because of the presence of ignitable fibers or flyings. Equipment listed for installation in Class III locations is designed to exclude the fibers and flyings from the equipment enclosure and to function without developing excessive surface temperatures.

Definitions

Associated Apparatus — Apparatus, including Category ia and ib apparatus, in which the circuits are not necessarily intrinsically safe themselves, but which affect the energy in the intrinsically safe circuits and are relied upon to maintain intrinsic safety. Associated electrical apparatus may be either:

- a) Electrical apparatus that has an alternative type of protection for use in the appropriate potentially flammable atmosphere; or
- b) Electrical apparatus not so protected and thus not suitable for use in a potentially flammable atmosphere.

Control Drawing — A drawing or other document provided by the manufacturer of the intrinsically safe or associated apparatus that details the allowed interconnections to other circuits or apparatus. If the intrinsically safe or associated apparatus is investigated under the entity concept, the control drawing will include the applicable electrical parameters to permit selection of apparatus for interconnection.

Entity Evaluation Concept — A method used to determine acceptable combinations of intrinsically safe apparatus and connected associated apparatus that have not been investigated in such combination.

Hazardous (Classification) Location — A location in which fire or explosion hazards may exist due to an explosive atmosphere of flammable gases or vapors, flammable liquids, combustible dust, or easily ignitable fibers or flyings.

Intrinsically Safe Circuit — A circuit in which any spark or thermal effect, produced either normally or in specified fault conditions, is incapable, under the test conditions prescribed in this standard, of causing ignition of a mixture of flammable or combustible material in air in the mixture’s most easily ignited concentration.

Nonincendive Circuit — A circuit, other than field wiring, in which any arc or thermal effect produced under intended operating conditions of the equipment is not capable, under specified test conditions, of igniting the flammable gas-air, vapor-air, or dust-air mixture.

Entity Evaluation Concept

The Model 350 I.S. and 355 I.S. indicators have been approved under the entity evaluation concept, which allows the interconnection of intrinsically safe devices in hazardous areas even though these devices were not

specifically approved in this combination. This means that not only can the instrument be used with GSE FM Approved loadcells and peripherals, but they can also be used with any manufacturer's FM Approved loadcells and peripherals provided that they have matching entity ratings and are approved for the appropriate hazardous area.

The criteria for interconnection is that the maximum input voltage and current, which intrinsically safe apparatus can receive and remain intrinsically safe, considering faults, must be equal to or greater than the maximum output voltage and current levels which can be delivered by the associated apparatus, considering faults and applicable factors. In addition, the maximum internal capacitance and inductance of the intrinsically safe apparatus, including interconnecting wiring, must be less than or equal to the maximum allowed capacitance and inductance which can be safely connected to the associated apparatus. If these criteria are met, then the combination may be connected and remain intrinsically safe. If the specific capacitance and inductance ratings of the wiring are unknown, use a capacitance of 60pF/ft and an inductance of 0.2uH/ft.

When connecting a Model 350 I.S. or 355 I.S. to another intrinsically safe device, the entity ratings must be compared and satisfy the conditions shown in the following table.

350 I.S./355 I.S. Indicator	Condition	Intrinsically Safe Device
Voc	\leq	Vmax or Ui
Isc	\leq	Imax or Ii
Ca	\geq	Ci + cable capacitance
La	\geq	Li + cable inductance
Po	\leq	Pi

Entity Rating Definitions

Voc or Uo – the maximum open circuit voltage that may be present at the specified terminals

Isc or Io – the maximum short circuit current that may be present at the specified terminals

Ca or Co - the maximum capacitance that may be connected to the specified terminals

La or Lo - the maximum inductance that may be connected to the specified terminals

Po - the maximum output power from the specified terminals

Lo/Ro – inductance to resistance ratio that indicates the maximum inductance per ohm of resistance that can be connected to the specified terminals

Vmax or Ui – the maximum voltage that may be connected to the specified terminals

Imax or Ii - the maximum current that may be connected to the specified terminals

Ci – the capacitance present at the specified terminals

Li – the inductance present at the specified terminals

Pi – the maximum power that may be supplied to the specified terminals

Li/Ri – the maximum internal inductance to resistance ratio at the specified terminals

Entity Ratings

Terminal	Description	Voc	Isc	Po	Ca	La	Group
J10	Loadcell (5V EXC)	7V	400mA	700mW	8.3uF	198mH	A-G, IIC-IIA
J10	Loadcell (8V EXC)	14 V	400mA	1.4W	4.6uF	945.2uH	C-G, IIB-IIA
J8	COMM 1&2	7V	50mA	87.5mW	15.4uF	13.7mH	A-G, IIC-IIA
J11	Remote Keys	7V	62mA	109mW	15.4uF	9mH	A-G, IIC-IIA
J5	Remote Display	7V	50mA	87.5mW	15.7uF	13.7mH	A-G, IIC-IIA

Factory Mutual Approval

The Model 350 I.S. and 355 I.S. indicators and options have been approved for the following hazardous areas:

Factory Mutual Project Identifier: 3018357

Indicator/Option	Approval
M350 I.S./M355 I.S. (5V Excitation) 20H350-00010 20H350-00020 20H350-00030 20H355-00010 20H355-00020 20H355-00030	I.S. for CL I-III, DIV 1, GP A-G I.S. for CL I, ZN 0, GP IIC-IIA N for CL I, DIV 2, GP A-D N for CL I, ZN 2, GP IIC-IIA S CL II-III, DIV 2, GP F-G T4 (Ta=50°C)
M350I.S./M355 I.S. (8V Excitation) 20H350-00011 20H350-00021 20H350-00031 20H355-00011 20H355-00021 20H355-00031	I.S. for CL I-III, DIV 1, GP C-G I.S. for CL I, ZN 0, GP IIB-IIA N for CL I, DIV 2, GP A-D N for CL I, ZN 2, GP IIC-IIA S CL II-III, DIV 2,GP F-G T4 (Ta=50°C)
Battery Power Supply Option 24H3502-201C0	I.S. for CL I-III, DIV 1, GP A-G I.S. for CL I, ZN 0, GP IIC-IIA N for CL I, DIV 2, GP A-D N for CL I, ZN 2, GP IIC-IIA S CL II-III, DIV 2,GP F-G T3 (Ta=40°C)
AC to DC Power Supply Option 24H3501-200C0 (single output used)	AIS for CL I-III, DIV 1, GP A-G CL I, ZN 1, AEx m [ia] GP IIC-IIA N for CL I, DIV 2, GP A-D N for CL I, ZN 2, GP IIC-IIA S CL II-III, DIV 2,GP F-G S CL I-III, DIV 1,GP A-G* T4 (Ta=50°C) * When installed in a CL I-III, DIV 1, GP A-G location, conduit must be used on the AC supply cable.
AC to DC Power Supply Option 24H3501-200C0 (dual outputs used)	AIS for CL I-III, DIV 1, GP C-G * CL I, ZN 0, GP IIB-IIA * N for CL I, DIV 2, GP A-D N for CL I, ZN 2, GP IIC-IIA S CL II-III, DIV 2,GP F-G S CL I-III, DIV 1,GP C-G* T4 (Ta=50°C) * When installed in a CL I-III, DIV 1, Group C-G location, conduit must be used on the AC supply cable.

NEMKO Approval (ATEX)

Recapitulation of certification

NEMKO approval number 04ATEX1356X



III GD T117°C
 II2(1)GD T64°C
 II2(1)GD T193°C

ITEM		Intrinsic Safety APPROVAL								
Description	GSE part number	Equipment Group	Category	Rating gases, Mist Vapors, Mist	Rating Dusts	Class	group	Zone	T rating	Ta
350IS 355IS Standard Indicators	20H350-XXXX0 20H355-XXXX0	II	1	G T 117°C	D	1	IIC	0	T4	50°C
350IS 355IS Indicators with 8V Exc.	20H350-XXXX1 20H355-XXXX1	II	1	G T 117°C	D	1	IIB	0	T4	50°C
M3502 Battery Power Supply	24H3502-201C0	II	1	G T 193°C	D	1	IIC	0	T3	40°C
AC-DC Power Supply Single output	24H3501-200C0	II	2	G	D T 64°C	1	IIC	1	T4	50°C
AC-DC Power Supply Dual output	24H3501-200C0	II	2	G	D T 64°C	1	IIC	1	T4	50°C

Above NEMKO ratings include the following options:

24H350-100B0 Fiber Optic Transceiver Option Kit

Following components must be used in a safe area, these products do not have NEMKO approval:

24S350-100A0 Safe Area Hub Kit, M350/355IS

24S350-200B0 Battery Charger, M350/355IS

CSA Approval

Master Contract Number: 22640

Certificate Number: 1538366

Ex nL IIC:

Class I, Division 2, Groups A, B, C, D

Weight indicators, Models 350 I.S. and 355 I.S., powered by either battery pack module, Model 3502 or associated apparatus AC-DC power supply, Model 3501, rated 90-250 VAC, 50/60 Hz, 120 mA with single I.S. output rated 12.7 volt, 315 mA. Non-Incendive when installed per Control Drawing 41533. Temp. Code T4 at Tamb = 50°C.

Ex nL IIC:

Class I, Division 2, Groups C, D

Weight indicators with 8 Volt excitation option board, Models 350 I.S. and 355 I.S., powered by either battery pack module, Model 3502 or associated apparatus AC-DC power supply, Model 3501, rated 90-250 VAC, 50/60 Hz, 120 mA with single I.S. output rated 12.7 volt, 315 mA. Non-Incendive when installed per Control Drawing 41533. Temp. Code T4 at Tamb = 50°C.

Ex ia IIC:

Class I, Groups A, B, C, D; Class II, Groups E, F, G; Class III:

Weight indicators, Models 350 I.S. and 355 I.S., powered by either battery pack module, Model 3502 or associated apparatus AC-DC power supply, Model 3501, rated 90-250 VAC, 50/60 Hz, 120 mA with single I.S. output rated 12.7 volt, 315 mA. Intrinsically Safe when installed per Control Drawing 41533 with the Entity Parameters listed. Temp. Code T4 at Tamb = 50°C.

Ex ia IIB:

Class I, Groups C, D; Class II, Groups E, F, G; Class III:

Weight indicators with 8 Volt excitation option board, Models 350 I.S. and 355 I.S., powered by either battery pack module, Model 3502 or associated apparatus AC-DC power supply, Model 3501, rated 90-250 VAC, 50/60 Hz, 120 mA with dual single I.S. output rated 12.7 volt, 315 mA. Intrinsically Safe when installed per Control Drawing 41533 with the Entity Parameters listed. Temp. Code T4 at Tamb = 50°C.

Item	GSE Part Number	Approval		
5 Volt Excitation 350 I.S.	20H350-00010 20H350-00020	Class I, Div. 2, Groups A, B, C, D	Ex nL IIC	T4 at Tamb =50°C
	20H350-00030 20H350-06010 20H350-06020 20H350-06030	Class I, Groups A, B, C, D; Class II, Groups E, F, G; Class III	Ex ia IIC	T4 at Tamb =50°C
5 Volt Excitation 355 I.S.	20H355-00010 20H355-00020	Class I, Div. 2, Groups A, B, C, D	Ex nL IIC	T4 at Tamb =50°C
	20H355-00030 20H355-06010 20H355-06020 20H355-06030	Class I, Groups A, B, C, D; Class II, Groups E, F, G; Class III	Ex ia IIC	T4 at Tamb =50°C
8 Volt Excitation 350 I.S.	20H350-00011 20H350-00021	Class I, Div 2, Groups C, D	Ex nL IIC	T4 at Tamb =50°C
	20H350-00031 20H350-06011 20H350-06021 20H350-06031	Class I, Div 2, Groups C, D; Class II, Groups E, F, G; Class III	Ex ia IIB	T4 at Tamb =50°C
8 Volt Excitation 355 I.S.	20H355-00011 20H355-00021	Class I, Div 2, Groups C, D	Ex nL IIC	T4 at Tamb =50°C
	20H355-00031 20H355-06011 20H355-06021 20H355-06031	Class I, Div 2, Groups C, D; Class II, Groups E, F, G; Class III	Ex ia IIB	T4 at Tamb =50°C

Standard Functions

The Model 350 I.S. and 355 I.S. include built-in functions that you can enable through the Indicator Setup. Refer to Chapter 3: Configuration for information on the setup and operation of the following standard functions:

- Check-weighing
- Parts counting
- Remote key operation
- Selectable, built-in data transmission formats
- Custom data transmissions

Standard Features

- Three display choices (LCD, LCD backlit and LED).
- LED model uses low current high efficiency display digits and annunciators to save battery life and adds brightness to dimly lit areas.
- Real time clock with battery backed time and date.
- Two RS-232 communication ports.
- Model 355I.S. has a numeric keypad
- Stainless Steel washdown enclosure
- Up to (4) 350 ohm loadcells
- Easily update firmware via the RS-232 port

Specifications

PERFORMANCE

Full Scale (F.S.)	Selectable 0 to 999,999
Resolution	20-bit A/D converter, 100,000d displayed, 1,000,000d internal
A/D Conversion	60 Hz
Zero Track	0 – 100% of Full Scale
Operating Temperature	-10°C to +40°C
Units of Measure	lb, kg, oz, g, lb-oz

ELECTRICAL

Power Requirement Input (J14):	5.1V – 12V DC
Excitation Voltage	5 VDC or 8V DC
Excitation Current	57 mA max. (5V EXC) or 91mA max. (8V EXC) / (4) 350Ω bridge
F.S. Signal Input	0.1 mV/V min – 10 mV/V max
Signal Connection	4 lead or 6 lead with sense

PROCESS CONTROL

Remote Input	2 momentary contact closure (100ms minimum) TARE, PRINT, ZERO
--------------	--

ENCLOSURE

Shipping Weight	7 lb (3 kg)
Material	304 Stainless Steel, NEMA 4X/IP66 Design
Mounting	2 swivel brackets are available for battery or AC operation

DISPLAY

LED	6-digit weight display, 0.8" (22mm) height 12 LED annunciators for operational status
LCD	6-digit weight display, 1.0" (25.4mm) height 12 LCD annunciators for operational status. Built in LCD status bargraph. Also available with backlight

COMMUNICATION

RS-232	(2) RS232 communication ports, 1 with hardware handshaking
--------	--

KEYPAD

350 I.S.	Five key, durable elastomeric (rubber)
355 I.S.	22 key, full numeric, durable elastomeric (rubber)

SAFE AREA OPTIONS

Battery Charger	Charges completely discharged battery option in 3.5 hours Universal AC input 85-265VAC, 50/60 Hz
Fiber Optic Hub	Model 355, installs in the safe area and connects to a Model 350/355 I.S. Allows setpoint and/or analog output options. Communicates with hazardous area indicator via fiber-optic cable.

HAZARDOUS AREA OPTIONS

Battery	Stainless steel enclosure, mounts to indicator swivel bracket. 200 hours continuous use with LCD display + 1 loadcell, and 100 hours continuous use with LED display + 1 loadcell. Charge time 3.5 hours with battery charger option.
AC to DC Power Supply	Stainless steel enclosure. Powers up to 2 indicators (2 indicators can only be powered in Groups C-G hazardous area). Wall mount. Universal AC input 90-250VAC, 50/60 Hz.
Power Extension Cable	Allows the AC-DC power supply to be mounted away from the indicator. 25 feet and 50 feet lengths available.

Display

The Model 350 and 355 intrinsically safe indicators are available with a six digit, 7-segment red LED display, six digit, 7-segment black LCD display or 7-segment backlit LCD display. The Model 350 and 355 I.S. will display alphanumeric data, but due to the nature of 7-segment LEDs/LCD and the limitation of six digits, some information is abbreviated.

All segments and annunciators are illuminated for a brief display test upon power up. The current gross weight is then displayed in default units.

LED Display

The LED display is a six digit, 7-segment bright red LED screen with 12 annunciators to show weight and status information. The SP1, SP2, and SP3 annunciators are red, green, and yellow. Also there is an annunciator for a third unit under kg. Place the third unit label above the third annunciator (the third unit is available on both the LED and LCD displays). See page 42 for third unit setup.

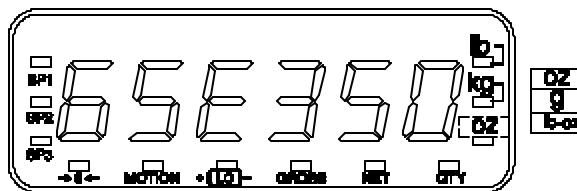

Figure 1: Model 350/355 I.S. LED Display

LCD Display

The LCD display is a six digit, 7-segment black LCD screen with 12 annunciators and a bargraph to show the operational status.

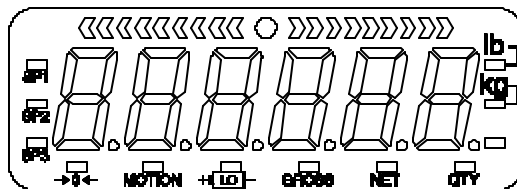

Figure 2: Model 350/355 I.S. LCD Display

Annunciators

Annunciators provide mode and status information. When illuminated, they indicate the following conditions:

- SP1** Setpoint #1 activated (relay 1 closed).
- SP2** Setpoint #2 activated (relay 2 closed).
- SP3** Setpoint #3 activated (relay 3 closed).
- 0←** Displayed weight is at center-of-zero ($\pm 1/4$ display graduation).
- MOTION** Scale is in motion. Motion inhibited transmits and motion inhibited setpoint activation will be delayed until motion ceases.
- LO** Lights when the battery reaches a low tolerance.
- GROSS** Displayed value represents the current gross weight.
- NET** Displayed value represents the current net weight.
- QTY** Displayed value represents the current piece quantity (Count).
- lb** The displayed value is represented in pounds.
- kg** The displayed value is represented in kilograms.
- Oz, lb oz, g** The displayed value is represented in either ounces, pound ounces or grams.

350 I.S. KEYPAD

The Model 350 I.S. offers a sealed 5-button elastomer keypad is used for operator input. Each key is assigned two distinct functions. Various key combinations are also used. Each key has secondary functions; allowing an operator to enter target values, perform piece samples, access setup parameters, etc.

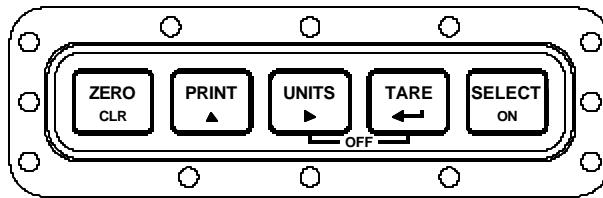

Figure 3: Model 350 I.S. Keypad

Secondary Functions

The Model 350 I.S. keypad performs different functions in the Weigh Mode, the Setup Mode, and the Calibration Mode. Secondary functions for each key allow you to perform additional tasks.

Key Press	Weigh Mode	Count Mode	Setup Mode
ZERO CLR	Performs a gross zero function and/or clears an entry in progress. Hold this key on power-up to turn on the display regardless of P420.	Performs a quantity zero function and/or clears an entry in progress.	Exits the Setup Mode and/or answers "NO" to query prompts and/or clears an entry in progress.
PRINT ▲	Performs a print function and/or 'scrolls' through digits during setpoint entry.	Performs a print function and/or 'scrolls' through digits during setpoint entry.	'Scrolls' through digits during data entry.
UNITS ▶	Toggles between 'lb' and 'kg' and/or advances cursor to next entry position.	Toggles through standard sample sizes and/or begins a new sample entry.	Advances cursor to next entry position and/or cycles prompts.
TARE ←	Performs an auto-tare function (if enabled) and/or accepts an entry in progress.	Performs an auto-tare function and requests a piece sample and/or accepts an entry in progress.	Accepts an entry in progress and/or 'scrolls' through parameter sub-set selections and/or answers 'YES' to query prompts.

Key Press	Weigh Mode	Count Mode	Setup Mode
	Toggles between display modes and/or restores power to the indicator (if auto-shutoff enabled).	Toggles between display modes and/or restores power to the indicator (if auto-shutoff enabled).	Advances to the next setup parameter.
+	Access Local Setup Mode.	Access Local Setup Mode.	No function.
+	No function.	No function.	Return to the previous setup parameter.
+	Absolute clear – clears an entry in progress and/or clears the value of a parameter.	No function.	Clears any entry in progress.
+	Backspace – erases the right-most digit during data entry.	Backspace – erases the right-most digit during sample entry.	Backspace – erases right-most digit during data entry.
+	Turn off indicator by holding key for approximately 1 second.	Turn off indicator by holding key for approximately 1 second.	Turn off indicator by holding key for approximately 1 second.
+	Extended gross.	Extended gross.	No function.
+	Reverse character scroll during data entry.	Reverse character scroll during sample entry.	Reverse character scroll during data entry.

355 I.S. Keypad

The Model 355 I.S. keypad performs different functions in the Weigh Mode, the Setup Mode, and the Calibration Mode. The number keys make entering a tare value or average piece weight easier.

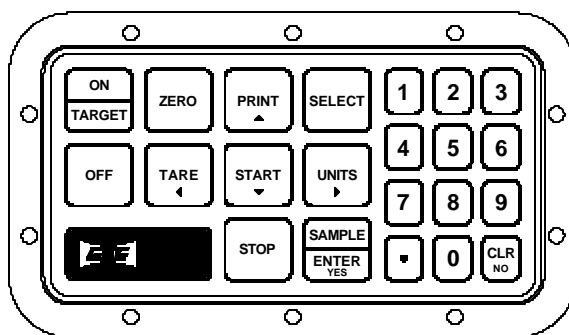

















Figure 4: Model 355 I.S. Keypad

Key Press	Weigh Mode	Count Mode	Setup Mode
	Performs a gross zero function and/or clears an entry in progress.	Performs a quantity zero function and/or clears an entry in progress.	Exits the Setup Mode and/or answers “NO” to query prompts and/or clears an entry in progress.
	Performs a print function and/or ‘scrolls’ through digits during setpoint entry.	Performs a print function and/or ‘scrolls’ through digits during setpoint entry.	‘Scrolls’ through digits during data entry.
	Toggles between ‘lb’ and ‘kg’ and/or advances cursor to next entry position.	Toggles through standard sample sizes and/or begins a new sample entry.	Advances cursor to next entry position and/or cycles prompts.
	Performs an auto-tare function (if enabled) and/or accepts an entry in progress. If the tare weight is	Performs an auto-tare function and/or accepts an entry in progress.	Accepts an entry in progress and/or ‘scrolls’ through parameter sub-set





Key Press	Weigh Mode	Count Mode	Setup Mode
	known, key in the value and press  .		selections and/or answers 'YES' to query prompts.
	Toggles between display modes and/or restores power to the indicator (if auto-shutoff enabled).	Toggles between display modes and/or restores power to the indicator (if auto-shutoff enabled).	Advances to the next setup parameter.
	Performs a sample. If a number is keyed in before hand, it will be used as the sample size. Accepts an entry.	Performs a sample. If a number is keyed in before hand, it will be used as the sample size.	Accepts an entry.
	Clears an entry in progress. Hold this key on power-up to turn on the display regardless of P420.	Performs a quantity zero function and/or clears an entry in progress.	Exits the Setup Mode and/or answers "NO" to query prompts and/or clears an entry in progress.
	If setpoints are enabled, causes a process to start or resume. See parameter 5003 on page 47 for details on enabling the START function.	If setpoints are enabled, causes a process to start or resume. See parameter 5003 on page 47 for details on enabling the START function.	No function
	If setpoints are enabled, causes a pause. Press  again to abort the process. See parameter 5002 on page 47 for details on enabling the STOP function.	If setpoints are enabled, causes a pause. Press  again to abort the process. See parameter 5002 on page 47 for details on enabling the STOP function.	No function
	Wake up the indicator if in sleep mode. Turn on the indicator if power is off. Access the target entry mode. See parameter 5000 on page 47 for details on enabling the TARGET function.	Wake up the indicator if in sleep mode. Turn on the indicator if power is off. Access the target entry mode. See parameter 5000 on page 47 for details on enabling the TARGET function.	No function
	Turn off indicator by holding key for approximately 1 second.	Turn off indicator by holding key for approximately 1 second.	Turn off indicator by holding key for approximately 1 second.
 + 	Access Local Setup Mode.	Access Local Setup Mode.	No function



When the 355 I.S. keypad is installed with a new main board, the 355 I.S. keypad must be initialized. Hold down the  key while power is applied. If the keypad was enabled, the display will show "EntHld". To reestablish the keypad as a 350 I.S., hold down the  key of the 350 I.S. keypad while power is applied by pressing the  key.



Weigh Mode Functions

The Model 350 I.S. and Model 355 I.S. keypads have five primary Weigh Mode functions:

-  Performs a gross zero and selects the gross mode.
-  Initiates data transmission out the communication port.
-  Toggles the units of measure between lb, kg, g, lb oz, oz.
-  Tares any displayed weight and selects the net mode.
-  Toggles the display between GROSS, NET, QUANTITY and setpoint TARGETS (if enabled).

Entering a Tare Value (Model 350)

If a tare value is known, it is possible to enter that value into the tare register. Follow the steps below.

1. From the tare mode use the  key to scroll in the first number.
2. Press the  key to move to the next digit.
3. Repeat steps 1 and 2 until the desired number is showing on the display.
4. Press the  key to accept the entered tare value.

Entering a Tare Value (Model 355)

If a tare value is known, it is possible to enter that value into the tare register. Follow the step below.

1. Key in the known tare value and press . The display will access the net mode.

Chapter 2: Installation

This chapter covers installation of the indicator and all options.

System Diagrams

The control drawing details the allowed interconnections between the Model 350 I.S. and Model 355 I.S. indicators, their options, and other possible devices. The drawing also shows the entity ratings of the indicators to allow easy selection of other devices approved under the entity concept. See Appendix C: Control Drawings for further details.

Outline Drawings

The outline drawings provide measurements needed for indicator installation.

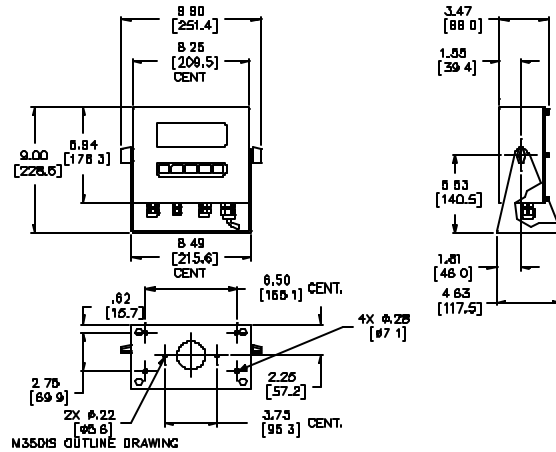

Figure 5: Model 350 I.S. with Standard Swivel Bracket

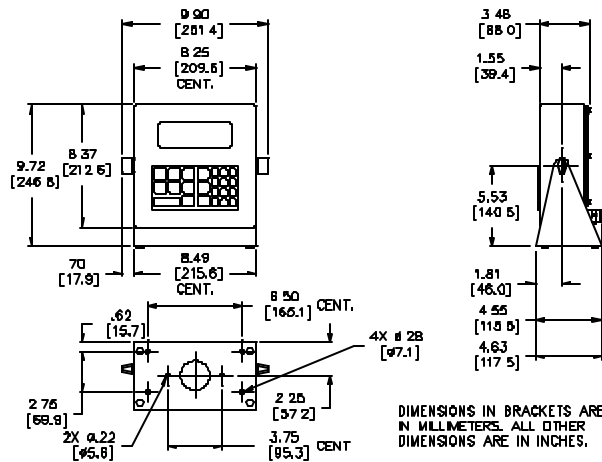

Figure 6: Model 355 I.S. with Standard Swivel Bracket

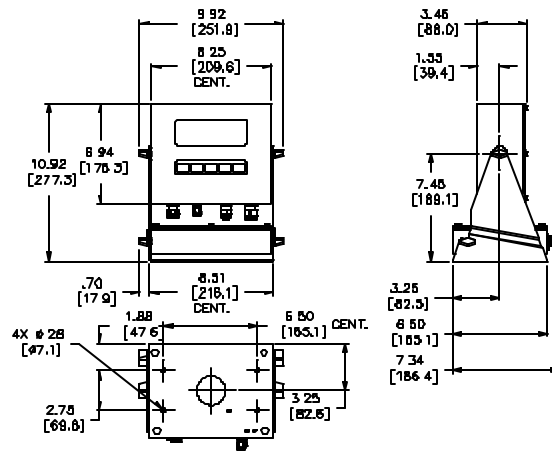

Figure 7: Model 350 I.S. with Battery Swivel Bracket

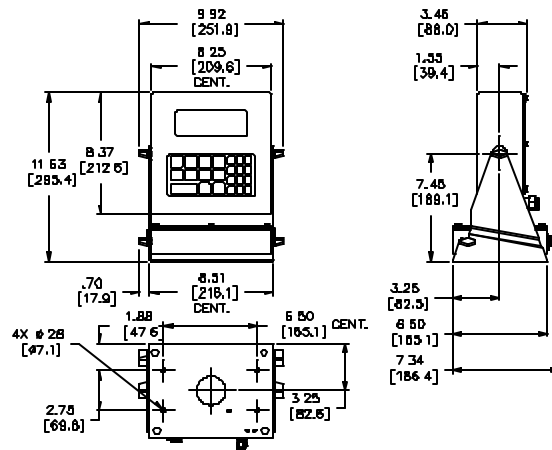

Figure 8: Model 355 I.S. with Battery Swivel Bracket

Load Cell Connections

A high quality braided shield cable with 16 to 24 AWG stranded wire is recommended for load cell or summing box connections. Rout the load cell cable through the strain relief supplied on the bottom of the enclosure. Either four or six conductor cables can be used.



Do not tin the ends of the load cell wire! A terminal connection free from the effects of vibration and oxidation can be assured only if the load cell terminals securely grip a bare, stranded wire.

When using four conductor cables move the sense jumpers to the internal position. When using six conductor cables move the sense jumpers to the external position. Utilizing the (+) and (-) Sense leads of six conductor cables provides compensation for variations in the excitation voltage due to resistance changes in the cable. See Figure 9 for the load cell connector.

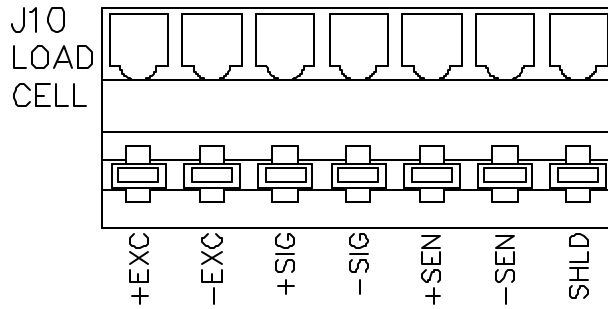
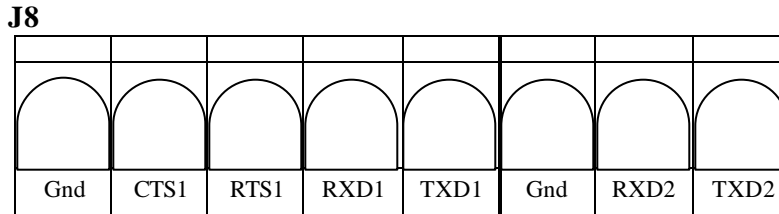

Figure 9: Model 350 I.S. and Model 355 I.S. Load Cell Connector (J10)

Communication Port Connections

The 350 I.S. and 355 I.S. come standard with two RS-232 communication ports. Every device connected to a communication port of the Model 350/355 I.S. must be approved for the appropriate hazardous area and entity parameters. Refer to the diagram below for connections to each communication port.



Remote Key Connections

The Model 350 I.S. and Model 355 I.S. accommodate two remote keys connections. A remote switch may be connected to J11 on the main board to provide remote activation of print, tare, or zero functions. The remote switch being connected must be approved for the appropriate hazardous area and entity parameters.

The connection for the remote switch input for remote key 1 is between key 1 and GND. Connect a second remote switch to key 2 and GND.

A two-conductor shielded cable between 28 and 20 AWG is recommended. The input requires a contact closure from a push-button switch, a 'dry' relay contact, a photo-eye, and a proximity sensor or other such device. A closure initiates the operation specified at P800. A closed switch will conduct 2.2 mA.

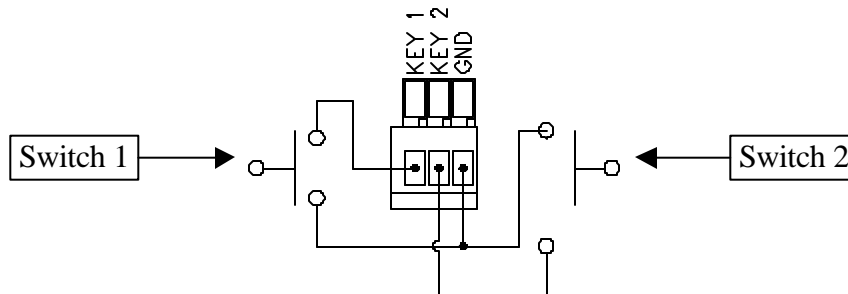

Figure 10: Remote Key Connection



Do not apply an external voltage to remote key terminals! Only a contact closure is required to activate the remote key input.

The open circuit voltage across the remote key pins is +5 VDC. A closed switch will conduct about 0.25 mA. Therefore, a low-voltage switch with gold-plated contacts is recommended. A Mercury-wetted switch will also work well. A minimum contact duration of 100 ms is required. Once invoked, the selected remote key operation will not repeat until the contact is released and closed again. See page 80 for Remote Key Configuration.

Remote Display Connections

It is possible to connect one Model 350/355 I.S. indicator to another Model 350/355 I.S. and have the remote indicator display a copy of the master indicator or customize the display of the remote (slave) indicator. The remote (slave) indicator's keypad will operate the master indicator. Refer to the drawing below to connect the master indicator to the remote (slave) indicator. Refer to page 84 to configure the master and remote (slave) displays. There are several different configurations for Master to remote (slave) indicator connection and setup. Since there are two communication ports on both the master and slave units, it is possible to connect a printer or computer.

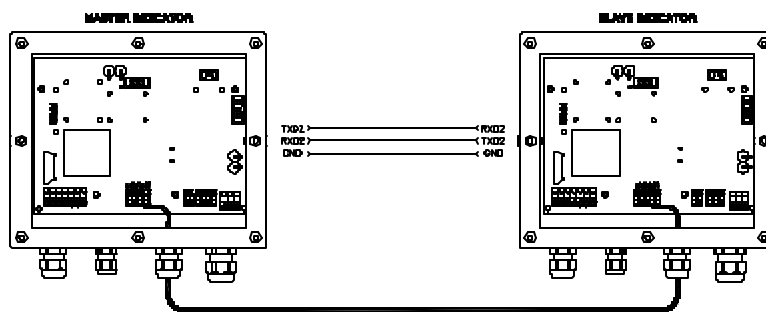

Figure 11: Master Indicator to Remote (slave) Indicator Connections

Hazardous Area Options

These options have been Factory Mutual approved to operate in a hazardous area. DO NOT INSTALL THE SETPOINT OPTION OR ANALOG OUTPUT OPTION INSIDE OF THE Model 350/355 I.S. ENCLOSURE LOCATED IN THE HAZARDOUS AREA. INSTALL THESE OPTIONS IN THE SAFE AREA HUB. REFER TO PAGE 21 FOR INSTALLATION INSTRUCTIONS.

Battery Power Supply (External)

Part number 24H350-3502A

The battery is enclosed in a stainless steel case and cannot be removed from the case. The battery module is mounted on the indicator swivel bracket. The battery will operate approximately 200 continuous hours with LCD display (backlight off, 1 load cell and no options installed) or 100 hours with the LED display (one load cell and no options installed). [Please do not throw away old battery packs. Recycle or return to place of purchase for recycling.](#)

Mounting - Swivel Bracket

1. Hold the battery module in both hands. Make sure the connectors on the battery module are facing the back of the indicator.
2. Line up the two protrusions on each side of the battery module with the slide rails on the swivel bracket.
3. Push the module into the slide rails until the knobs drop into the slots in the swivel bracket.
4. Tighten the knobs to hold the battery module in the swivel bracket.

Battery Charging

The battery must be charged in the safe area. Connect the battery to the battery charger. Connect the battery charger to AC power. Charging will take approximately 3.5 hours.

Low Battery Indication

The low battery annunciator will be lit when the voltage reaches a low threshold and the low battery message (Lo Bat) is shown on the display for 1.5 seconds every 15 seconds.

Dead Battery Shutdown

The indicator will shutdown after five minutes of dead battery condition.

AC To DC Power Supply (External)

Part number 24H350-3501A

The AC-DC power supply is in a stainless steel enclosure which is remotely mounted. Capable of powering up to (2) Model 350/355 I.S. indicators in gas Groups C-G or IIB-IIA and (1) Model 350/355 I.S. indicator in gas Groups A-G or IIC-IIA. Refer to Figure 12 for mounting dimensions.

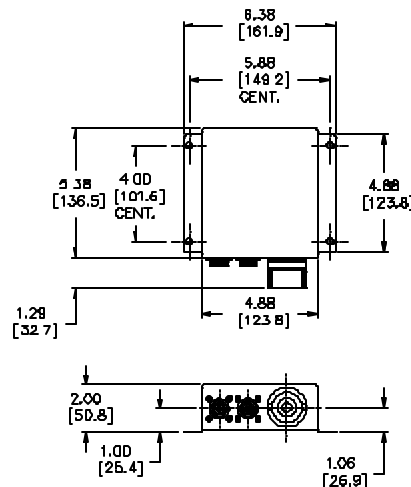

Figure 12: AC to DC Power Supply Outline Drawing

AC To DC Power Supply Extension Cable

The extension cable comes in either 25' or 50' length. This is for mounting the AC to DC converter away from the indicator.

5 Volt And 8 Volt Excitation

Two versions of excitation are available for the Model 350 I.S. and Model 355 I.S.. The 5-volt excitation consumes less power than the 8-volt excitation module. The 5-volt excitation is standard on the main board. The 8-volt excitation is on a separate board which is installed by the factory. The 5-volt excitation is +5V to 0V. The 8-volt excitation is +5V to -3V.

Fiber-Optic Interface

It is possible to use setpoints and analog output by interfacing the hazardous area indicator with a Model 355 in the safe area. A fiber-optic transceiver option kit (24H350-100B0) is necessary for the hazardous area indicator.

Fiber-Optic Board Installation

1. Remove the rear panel screws of the Model 350/355 I.S.
2. Locate the fiber-optic board connector (J6) on the Model 350/355 I.S. main board.
3. Snap the (4) ½ plastic standoffs provided with the fiber-optic board into the holes surrounding the J6 connector. This area is outlined.
4. Place the fiber-optic board on the standoffs but do not press onto the standoffs.
5. Line up the J1 connector on the back of the fiber-optic board with J6 on the Model 350/355 I.S. main board.
6. Press the fiber-optic board onto the plastic standoffs.
7. Remove the rubber plugs from the J2 and J3 connectors.
8. Follow the instructions on page XX for installing the fiber-optic cable to the fiber-optic board.

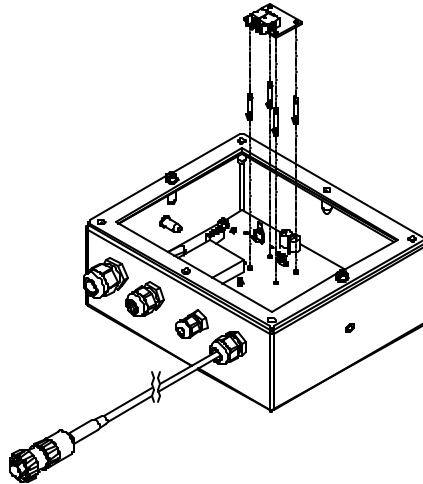

Figure 13: Fiber-optic Board Installation (Model 350/355 I.S.)

Safe Area Options

These options are to be installed in an area where a hazardous situation does not exist (safe area).

Safe Area Hub Kit

The safe area hub provides an enclosure to install options such as the setpoint output and analog output. Operation of setpoints and analog output will be done via fiber-optic interface. It is necessary to install a fiber-optic transceiver in both the safe area indicator and the hazardous indicator (see page 21 for installation in the hazardous area indicator. The safe area options only are to be installed inside of the Model 355 safe area hub indicator (200355-H0010).

Safe Area Hub Kit (24S350-100A0)

Quantity	Part Number	Description
1	200355-H0010	Safe Area Hub Indicator
8	17-20-0803	½" Nylon standoffs
2	26-20-1873S	Two hole seal
2	28-10-35037	Labels
2	39-10-41533	Control Drawings
2	420983-40369	Fiber-optic interface board

Fiber-Optic Board Installation

1. Remove the rear panel screws of the Model 355.
2. Locate the fiber-optic board connector (J16) on the Model 355 main board.
3. Snap the (4) ½ nylon standoffs provided with the fiber-optic board into the holes surrounding the J16 connector.
4. Place the fiber-optic board on the standoffs but do not press onto the standoffs.
5. Line up the J1 connector on the back of the fiber-optic board with J16 on the Model 355 main board.
6. Press the fiber-optic board onto the plastic standoffs.
7. Remove the rubber plugs from the J2 and J3 connectors.
8. Follow the instructions below for installing the fiber-optic cable to the fiber-optic board.

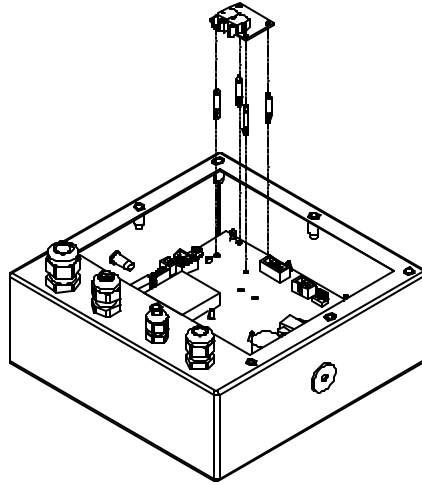

Figure 14: Safe Area Hub fiber optic board installation

Plastic Fiber-Optic Cable Installation And Termination

The plastic fiber-optic cable is an inexpensive way to connect an intrinsically safe indicator to a safe area hub indicator. The cable allows a distance of 200 feet maximum.

1. Unscrew cap from the strain relief next to the loadcell strain relief.
2. Remove rubber grommet from inside the strain relief
3. Insert the two-hole seal which was included with fiber-optic board kit. Install the small end of the seal first.
4. Reinstall the strain relief cap on the strain relief, but do not tighten. Refer to Figure 15.
5. Peel apart conductors of plastic fiber cable approximately 1'.
6. Insert plastic fiber conductors through seal holes in the strain relief.
7. Terminate plastic fiber conductors by using snap-on connectors (GSE p/n 26-20-4531) and polishing kit (GSE p/n 31-80-0225) according to termination instructions (GSE p/n 39-10-42119).
8. Plug fiber connectors into connectors on fiber-optic board. Make sure that RX goes to TX and TX goes to RX.
9. Tighten stain relief cap.

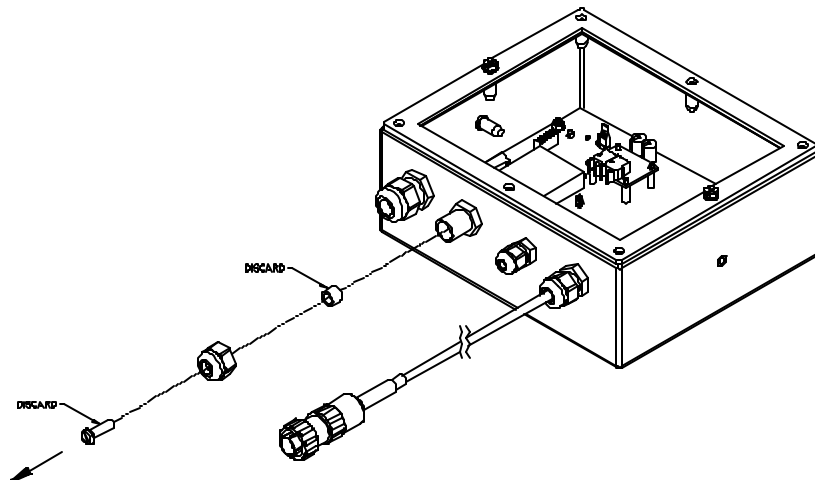

Figure 15: Fiber-Optic Cable Installation and Termination

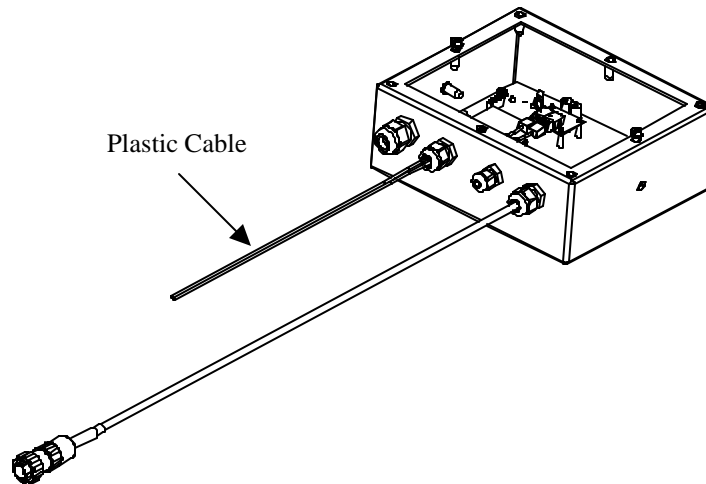

Figure 16: Fiber Optic Cable Installation (Plastic Cable)

HCS (Hard Clad Silica) Fiber-Optic Cable Installation

The HCS cable is glass fiber in a round jacket. The cable allows a distance of 1000 feet maximum. Since HCS fiber-optic cable is not easily fabricated on site and tooling is too expensive for on time use. Prefabricated cables in 100 feet increments can be purchased from GSE. The cable comes ready to install with connecting ends and a strain relief for the enclosure.

1. Remove the strain relief to the right of the load cell strain relief.
2. Insert the strain relief of the HCS cable through the strain relief hole of the enclosure.
3. Slide the strain relief nut over the HCS cable and screw it to the strain relief. Tighten nut with a 7/8" socket or wrench.
4. Plug fiber connectors into connectors on fiber-optic board.
5. Tighten strain relief cap.

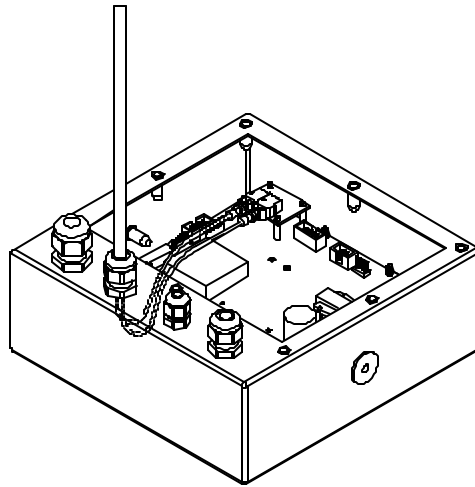



Figure 17: Fiber-Optic Cable Installation (HCS Cable)

Safe Area Setpoint Option Installation (Model 355 Hub Only)

Using one of the software setpoint configurations (see *General Setpoint Setup* on page 56) in conjunction with the setpoint option board gives the Safe Area Hub the ability to directly control external devices such as valves, relays, actuators, etc.

There are up to three setpoint outputs available. The activation and deactivation is controlled by the setpoint configuration. The outputs are capable of driving up to one Amp at 20-280VAC & 2 Amp at 3-60VDC. The solid state relays are normally open (NO) contacts.

	See <i>General Setpoint Setup</i> on page 56 for setpoint software configuration details.
---	---

	<p>The Safe Area Hub (Model 355) contains components which could be damaged by Electrostatic Discharge (ESD) if serviced improperly. Use proper ESD precautions (wear a wrist strap connected to ground, use grounded work stations, etc.) when opening the enclosure.</p> <p>High voltages may exist within the enclosure! To prevent the risk of electrical shock, ALWAYS unplug the Safe Area Hub when opening the enclosure. Installation and servicing of the Safe Area Hub should be performed by authorized and qualified service personnel only.</p> <p>Never connect or disconnect option board cables while the indicator is powered. Doing so may result in circuit board damage.</p>
---	---

1. Open the indicator.
Remove the eight screws from the back of the unit.
2. Locate the three studs and one thru-hole on the main board that the option mounting bracket will be attached to. See Figure 18. Remove the nuts from the three studs on the main board.
It may help to position the option mounting bracket over the main board to locate the three studs and one thru-hole.

3. Install the nylon stand-off supplied with the option bracket kit into the thru-hole on the option bracket. See Figure 18. The thru-hole on the option bracket is the irregular flanged section (a smaller hole than the others on the bracket).
4. Install the three hex stand-offs onto the studs on the main board.
Tighten the stand-offs gently with a 6 mm hex nut driver.
5. If this is the first option card, attach the loose end of the cable to the serial I/O connector (J3) on the main board. Let the card gently hang over to the outside of the enclosure until mounting. J3 is a 10-pin polarized connector.
This step is not necessary if this is the second card installed.
6. Position the nylon stand-off (attached to the bracket) into the hole on the main board while routing the threads of the other hex stand-offs through the holes on the bracket, while pressing down over the nylon stand-off until it snaps into place. Line-up the three other hex stand-offs into the bracket thru-holes first before securing the nylon stand-off into the main board thru-hole.
7. Secure the bracket into position with the hex nuts supplied with the kit. Do not over tighten.
8. Place one set (four pieces) of the nylon sleeve type stand-offs onto the four studs of the option bracket. Place the Setpoint Control Module, component side up, onto the nylon sleeve stand-offs. Install four hex nuts and secure gently.

Select the four studs closest to the (J3) connector of the main board to add the four sleeve stand-offs. Be sure the cable is already attached to (J3) on the main board before installing the card. Also be sure the cable is attached to the right-most connector (J3) (as viewed from the component side of the option board). The second connector (J1) is for 'daisy-chaining' another option card. The additional mounting hardware is supplied with the option bracket kit. This hardware should be saved for future use if not being used.
9. Route the analog cable through the available strain-relief. Make sure to connect cable conductors to the proper terminals before closing the unit.
10. Reinstall the back cover. Tighten the eight screws securely to create a good seal. Be sure to avoid 'pinching' the cable between the housing halves.

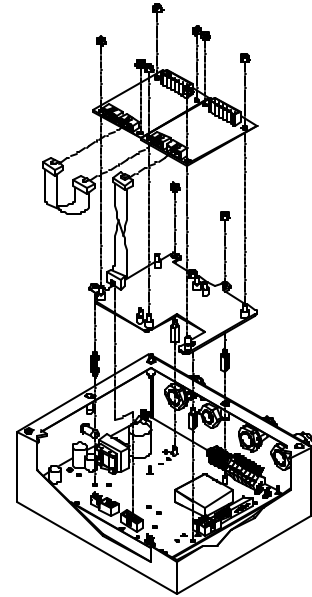



Figure 18: Setpoint Option Board Installation

Setpoint Board Diagnostic And Test Procedures

	<p>This test procedure affects the setpoint output. Be sure to disconnect all peripheral devices attached to the setpoint option card.</p>
---	--

To test the setpoint option card:

1. Enter the Setup Mode (see *Setup Mode* on page 32).
Chngs Poss!
P110.-- ~ F.S.= ~ 100.00
2. Key in .
- Test ~ Setpt**
Load Device Inactive
3. Attach the load and power source in series with Setpoint 1 contacts.
4. Press to activate only output #1.

Test ~ Spt 1

Load Device Active

5. Attach the load and power source in series with Setpoint 2 contacts.
6. Press  to activate only output #2.

Test ~ Spt 2

Load Device Active

7. Attach the load and power source in series with Setpoint 3 contacts.
8. Press  to activate only output #3.

Test ~ Spt 3

Load Device Active

Safe Area Analog Option Installation

The 16-bit electrically-isolated analog output module provides a highly accurate analog signal, proportional to weight in the safe area. This signal can be used for interfacing to PLCs, chart recorders, and other such devices.

	See <i>Analog Output Setup</i> on page 82 for analog output software configuration details.
---	---

	<p>The Model 350/355 I.S. contains components which could be damaged by Electrostatic Discharge (ESD) if serviced improperly. Use proper ESD precautions (wear a wrist strap connected to ground, use grounded work stations, etc.) when opening the enclosure.</p> <p>High voltages may exist within the enclosure! To prevent the risk of electrical shock, ALWAYS unplug the Model 350/355 I.S. when opening the enclosure. Installation and servicing of the Model 350/355 I.S. should be performed by authorized and qualified service personnel only.</p> <p>Never connect or disconnect option board cables while the indicator is powered. Doing so may result in circuit board damage.</p>
---	--

To install the Analog Output Module:

1. Open the indicator.
2. Remove the eight screws from the back of the unit.
3. Locate the three studs and one thru-hole on the main board that the option mounting bracket will be attached to. See Figure 19. Remove the nuts from the three studs on the main board.
4. It may help to position the option mounting bracket over the main board to locate the three studs and one thru-hole.
5. Install the nylon stand-off supplied with the option bracket kit into the thru-hole on the option bracket. See Figure 19. The thru-hole on the option bracket is the irregular flanged section (a smaller hole than the others on the bracket).
6. Install the three hex stand-offs onto the studs on the main board.
7. Tighten the stand-offs gently with a 6 mm hex nut driver.
8. If this is the first option card, attach the loose end of the cable to the serial I/O connector (J3) on the main board. Let the card gently hang over to the outside of the enclosure until mounting. J3 is a 10-pin polarized connector.
9. This step is not necessary if this is the second card installed.
10. Position the nylon stand-off (attached to the bracket) into the hole on the main board while routing the threads of the other hex stand-offs thru the holes on the bracket, while pressing down over the nylon stand-off until it snaps into place.

Figure 19: Analog Option Board

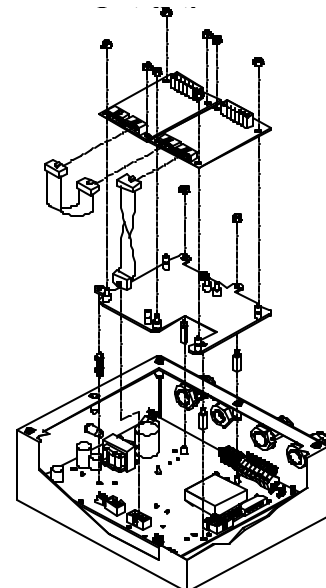

11. Line-up the three other hex stand-offs into the bracket thru-holes first before securing the nylon stand-off into the main board thru-hole.
12. Secure the bracket into position with the hex nuts supplied with the kit. Do not over tighten.
13. Place one set (four pieces) of the nylon sleeve type stand-offs onto the four studs of the option bracket. Place the Analog Output Module, component side up, onto the nylon sleeve stand-offs. Install four hex nuts and secure gently.
14. Select the four studs closest to the (J3) connector of the main board to add the four sleeve stand-offs. Be sure the cable is already attached to (J3) on the main board before installing the card. Also be sure the cable is attached to the right-most connector (J3) (as viewed from the component side of the option board). The second connector (J1) is for 'daisy-chaining' another option card. The additional mounting hardware is supplied with the option bracket kit. This hardware should be saved for future use if not being used.
15. Route the analog cable through the available strain-relief.
16. Make sure to connect cable conductors to the proper terminals before closing the unit.
17. Reinstall the back cover. Tighten the eight screws securely to create a good seal.
18. Be sure to avoid 'pinching' the cable between the housing halves.

Analog Board Diagnostic And Test Procedures



	The following test procedures affect the analog output signal levels. Be sure to <u>disconnect all peripheral devices</u> attached to the analog option card.
---	---

	Test equipment needed: precision DC voltmeter, 500 ohm precision resistor. The 500 ohm resistor must meet the following specifications: .01% tolerance and 5ppm temperature coefficient.
--	--

	This test procedure requires that the initial analog option calibration procedure has been completed.
---	---

To test the 0-10v output mode:











1. Enter the Setup Mode (see *Setup Mode* on page32).
Chngs Poss!
P110.-- ~ F.S.= ~ 100.00
2. Attach the voltmeter + (red) lead to pin 3 (0-10VDC) and the - (black) lead to pin 2 (ISOLATED GND) of the Analog Output connector.
3. Key in .
- Test ~ 0-10v**
Per P176
4. Press to set the output to 0%.
0-10v ~ 0P
0.00 V
5. Press to increase the output to 25%.
0-10v ~ 25P
2.50 V
6. Press to increase the output to 50%.
0-10v ~ 50P
5.00 V

7. Press  to increase the output to 75%.
0-10v ~ 75P
7.50 V
8. Press  to increase the output to 100%.
0-10v ~ 100P
10 V

To test the 0-20mA output mode:



Voltmeter readings are based on the use of a 500 ohm precision resistor. Caution! Do not exceed 500 ohms.

1. Enter the Setup Mode (see *Setup Mode* on page32).
Chngs Poss!
P110.-- ~ F.S.= ~ 100.00
2. Attach the precision resistor to pin 5 and pin 6.
3. Attach the voltmeter + (red) lead to pin 6 (0-20 mA) of the analog output connector.
4. Attach the voltmeter - (black) lead to pin 5 (ISOLATED GND) of the Analog Output connector.
5. Key in   (see *Setup Mode* on page32).
Test ~ 0-20A
Per P176
6. Press  to set the output to 0%.
0-20A ~ 0P
0.00 V
7. Press  to increase the output to 25%.
0-20A ~ 25P
2.5 V
8. Press  to increase the output to 50%.
0-20A ~ 50P
5 V
9. Press  to increase the output to 75%.
0-20A ~ 75P
7.5 V
10. Press  to increase the output to 100%.
0-20A ~ 100P
10 V

To test the 4-20mA output mode:



Voltmeter readings are based on the use of a 500 ohm precision resistor.
Caution! Do not exceed 500 ohms.

1. Enter the Setup Mode (see *Setup Mode* on page32).
Chngs Poss!
P110.-- ~ F.S.= ~ 100.00

2. Attach the precision resistor to pin 5 and pin 6.
3. Attach the voltmeter + (red) lead to pin 6 (4-20 mA) of the analog output connector.
4. Attach the voltmeter - (black) lead to pin 5 (ISOLATED GND) of the Analog Output connector.
5. Key in (see *Setup Mode* on page 32).

Test ~ 4-20A

Per P176

6. Press to set the output to 0%.
4-20A ~ 0P
2 V
7. Press to increase the output to 25%.
4-20A ~ 25P
4 V
8. Press to increase the output to 50%.
4-20A ~ 50P
6 V
9. Press to increase the output to 75%.
4-20A ~ 75P
8 V
10. Press to increase the output to 100%.
4-20A ~ 100P
10V

Chapter 3: Configuration

Instructions on how to enter the setup mode, make changes to parameters and exit the setup mode while saving changes.

This chapter includes setup for:

- Analog output
- Setpoints
- Time and date
- Custom Transmit
- Remote display
- Counting
- Remote key
- Upgrade firmware





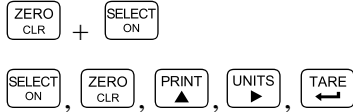

Entering the Setup Mode (Model 350 I.S.)

To prevent accidental changes to the Indicator Setup, a sequence of keystrokes is used to gain access to the Setup Mode. If the indicator is set for remote display, refer to page 84 for instructions on accessing the setup mode.





These keystrokes must be made within five seconds, or the indicator will return to the Weigh Mode.

To access the Setup Mode:

1. From the Weigh Mode, press  + 
DISPLAY READS ► Setup ~ Enter Code
2. Press 
DISPLAY READS ► .
3. Press 
DISPLAY READS ► ..
4. Press 
DISPLAY READS ► ...
5. Press 
DISPLAY READS ►
6. Press 
DISPLAY READS ► Chgs ~ Poss!
P110.— — ~ F.S.= ~ 100

To access Setup in a view-only mode:

1. From the Weigh Mode, press  + 
DISPLAY READS ► Setup ~ Enter Code
2. Press 
DISPLAY READS ► No ~ Chgs
P110.— — ~ F.S.= ~ 100



When exiting the Setup Mode, the Model 350/355 I.S. prompts whether to enter the Calibration Mode. (See page 94 for Calibration Mode procedures). The display will then prompt to save any changes.

Entering the Setup Mode (Model 355 I.S.)

To prevent accidental changes to the Indicator Setup, a sequence of keystrokes is used to gain access to the Setup Mode. If the indicator is set for remote display, refer to page 84 for instructions on accessing the setup mode.

1 0 0

2 3 6 4 0

These keystrokes must be made within five seconds, or the indicator will return to the Weigh Mode.

To access the Setup Mode:

1. From the Weigh Mode, key in 1 0 0
DISPLAY READS ► Setup ~ Enter Code
2. Key in 2 3 6 4 0
DISPLAY READS ► Chgs ~ Poss!
P110.— — ~ F.S.= ~ 100

To access Setup in a view-only mode:

1. From the Weigh Mode, key in 1 0 0
DISPLAY READS ► Setup ~ Enter Code
2. Press
DISPLAY READS ► No ~ Chgs
P110.— — ~ F.S.= ~ 100

Selecting a Parameter





To advance to the next parameter (Model 350 I.S. and Model 355 I.S.):

1. Press
DISPLAY READS ► P111.09 ~ 1Grad ~ 0.01
2. Press
DISPLAY READS ► P112.05 ~ Ztrac ~ 0.5 d
3. Continue pressing to advance through all setup parameters.

To access the previous parameter (Model 350 I.S.):

1. Press
DISPLAY READS ►.
2. Press
DISPLAY READS ► P111.09 ~ 1Grad ~ 0.01
3. Repeat + to back up one parameter.







To access the previous parameter (Model 355 I.S.):

1. Press 
DISPLAY READS ►.
2. Press 
DISPLAY READS ► P111.09 ~ 1Grad ~ 0.01
3. Repeat   to back up one parameter.



When accessing a parameter, the parameter number appears briefly. The display then toggles between the parameter name and selection. Pressing  will again briefly display the parameter number.

To access a specific parameter (for example P200) (Model 350 I.S.):



1. Press  four times to select the first digit.
DISPLAY READS ► 2
2. Press  to advance to the next digit.
DISPLAY READS ► 2.
3. Press  once to select the next digit.
DISPLAY READS ► 20
4. Press  to advance to the next digit.
DISPLAY READS ► 20.
5. Press  once to select the next digit.
DISPLAY READS ► 200
6. Press  to advance to the parameter.
DISPLAY READS ► P200.00 ~ Baud ~ 9600

To access a specific parameter (for example P200) (Model 355 I.S.):

1. Key in    
DISPLAY READS ► P200.00 ~ Baud ~ 9600

Changing a Parameter Value

Selection Parameters

Selection parameters have a pre-defined list of choices to pick from. Each choice is numbered and corresponds to a certain value. The choice number is shown to the right of the decimal point within the parameter number. Repeatedly pressing  (Model 350 I.S.) or  (Model 355 I.S.) while viewing a selection parameter cycles through the available choices, or you can key in the choice number.

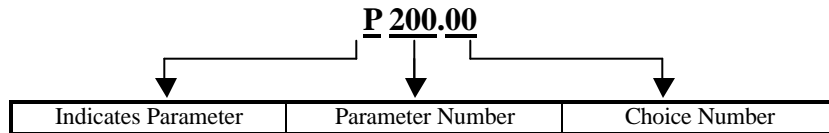

For example, parameter 200 is a selection parameter that holds the baud rate for the serial. This is a selection parameter because a choice number between 00 and 06 must be used. Each choice number corresponds to a different baud rate. To change the baud rate from the default value of 9600 to 4800, perform the following steps from the Setup Mode.

To change the baud rate from the default value of 9600 to 4800:

1. Key in
DISPLAY READS ► P200.00 ~ Baud ~ 9600
2. Press (Model 350 I.S.) or (Model 355 I.S.) once.
DISPLAY READS ► P200.01 ~ Baud ~ 4800

Key-In Parameters

Key-In Parameters are not limited to a list of choices, although there may be upper and lower value limits. A Key-In Parameter requires that a numeric value be entered using the front panel keys. Key-In Parameters are shown with two hyphens after a decimal point within the parameter number.

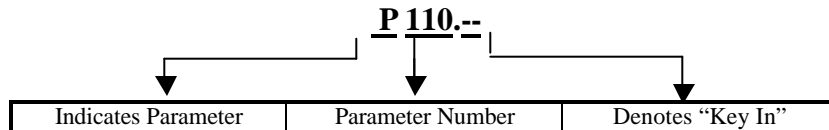

To enter a Key-In Parameter (350 I.S.):





1. Press . A decimal point is used to represent the entry position.
2. Press until the desired character appears.
3. Press . Another decimal point indicates the next entry position.
4. Repeat steps 1 and 2 until your desired entry value is shown.
5. Press to enter your numerical value.

To enter a Key-In Parameter (355 I.S.):





1. Key in the number by using the numeric keys.
2. Press to accept the entry.

To setup a full scale value of 250 lbs (350 I.S.):

1. Access the setup mode.
DISPLAY READS ► P110.— — ~ F.S.= ~ 100
2. Press four times to select the first digit.
DISPLAY READS ► 2





3. Press  to advance to the next digit.
DISPLAY READS ► 2.
4. Press  six times to select the next digit.
DISPLAY READS ► 25
5. Press  to advance to the next digit.
DISPLAY READS ► 25.
6. Press  once to select the next digit.
DISPLAY READS ► 250
7. Press  to enter the value.
DISPLAY READS ► P110.— — ~ F.S.= ~ 250

To setup a full scale value of 250 lbs (355 I.S.):



1. Access the setup mode.
DISPLAY READS ► P110.— — ~ F.S.= ~ 100
2. Key in     to accept the entry.
DISPLAY READS ► P110.— — ~ F.S.= ~ 250

Saving Parameters

To exit the Setup Mode and save changes (350 I.S.):

1. Press  to begin exiting Setup Mode.
DISPLAY READS ► Enter ~ =CAL!
2. Press  to bypass Calibration Mode.
DISPLAY READS ► Enter ~ =Stor
3. Press  to save setup changes.
DISPLAY READS ► Enter ~ =End
4. Press  to complete exit.
DISPLAY READS ► 0.00

To exit the Setup Mode and save changes (355 I.S.):

1. Press  to begin exiting Setup Mode.
DISPLAY READS ► Enter ~ =CAL!
2. Press  to bypass Calibration Mode.
DISPLAY READS ► Enter ~ =Stor
3. Press  to save setup changes.
DISPLAY READS ► Enter ~ =End

4. Press  to complete exit.

DISPLAY READS ► 0.00

To exit the Setup Mode from the view-only mode (350 I.S.):

1. Press  to begin exiting Setup Mode.

DISPLAY READS ► Enter ~ =End

2. Press  to complete exit.

DISPLAY READS ► 0.00

To exit the Setup Mode without saving changes (350 I.S.):

1. Press  to begin exiting Setup Mode.

DISPLAY READS ► Enter ~ =CAL!

2. Press  to bypass Calibration Mode.

DISPLAY READS ► Enter ~ =Stor

3. Press  to exit *without* saving changes.

DISPLAY READS ► Enter ~ =Undo

4. Press  to undo changes.

DISPLAY READS ► Enter ~ =End

5. Press  to complete exit.

DISPLAY READS ► 0.00

To exit the Setup Mode without saving changes (355 I.S.):

1. Press  to begin exiting Setup Mode.

DISPLAY READS ► Enter ~ =CAL!

2. Press  to bypass Calibration Mode.

DISPLAY READS ► Enter ~ =Stor

3. Press  to exit *without* saving changes.

DISPLAY READS ► Enter ~ =Undo

4. Press  to undo changes.

DISPLAY READS ► Enter ~ =End

5. Press  to complete exit.

DISPLAY READS ► 0.00

Factory Default

Parameter 65001 and 65002 are available to return the Model 350/355 I.S. to factory settings. Parameter 65001 will reset parameters including the calibration, while parameter 65002 resets all parameters except the calibration.

Return to factory default (350 I.S.):

1. Access the setup mode. See page 32 for details.
2. Key in or
DISPLAY READS ► *P65002~default-Cal*
3. Press once.
DISPLAY READS ► *Are U sure?~default=Enter*
4. Press once.
DISPLAY READS ► *Setup done~P65002~default-Cal*
5. Press

Return to factory default (355 I.S.):

1. Key in or
DISPLAY READS ► *P65002~default-Cal*
2. Press once.
DISPLAY READS ► *Are U sure?~default=Enter*
3. Press once.
DISPLAY READS ► *Setup done~P65002~default-Cal*
4. Press

List of Parameters

The Model 350 I.S. and Model 355 I.S. have several parameters that can be configured to your specific application. Below is a table of the available parameters. Also refer to page 41 for explanations of each parameter.

Table 1: Parameter Map

Parameter Number	Display Name	Default Value	Valid Range/ Choices	Parameter Description	Page
P110.--	<i>F.S.=</i>	100.00	.01 – 999,999 (Keyed In)	Full Scale	41
P111.09	<i>IGrad</i>	.01	.00001 – 500 (24 Selections)	Count By	41
P112.05	<i>Ztrac</i>	0.5d	Off - 20.0d (200 Selections)	Zero Track Aperture	41
P114.10	<i>Stabl</i>	1.0d	Off – 20.0d (200 Selections)	Stability Window	41
P115.10	<i>StDly</i>	1 Sec	0.05 – 10.0 Sec (101 Selections)	Stability (Motion) Delay	41
P116.04	<i>Filtr</i>	1 Sec	.065 – 8.00 Sec (8 Selections)	Filter Setting	41
P117.01	<i>Rate=</i>	0.1 Sec	0.05 – 20.0 Sec (201 Selections)	Display Update	42
P118.12	<i>Zrang</i>	100%	.01 – 100% (13 Selections)	Zero Button Range	42
P119.00	<i>LinrZ</i>	Disable	Enable / Disable (Toggle)	Linearization	42
P150.00	<i>Units</i>	lb	lb / kg (Toggle)	Default (Calibration) Units	42
P151.01	<i>Unbut</i>	Enable	Enable / Disable (Toggle)	Units Button	42
P152.00	<i>Unit3</i>	None	None / ounce / gram / lboz (4 Selections)	Additional Unit	42
P161.00	<i>TarSa</i>	Disable	Enable / Disable (Toggle)	Tare Save	42
P166.01	<i>AutoT</i>	Enable	Enable / Disable (Toggle)	Auto Tare	42
P167.01	<i>TarIn</i>	Disable (350) Enable (355)	Enable / Disable (Toggle)	Keyboard Tare	43
P169.00	<i>AtClr</i>	Disable	Enable / Disable (Toggle)	Auto Tare Clear	43
P171.00	<i>AnAlg</i>	Disable	Enable / Disable (Toggle)	Analog Output Option	43
P179.00	<i>Count</i>	Disable	Enable / Disable (Toggle)	Counting Functions	43
P200.00	<i>Baud1</i>	9600	150 – 115K (13 Selections)	Comm 1 Baud Rate	43
P201.01	<i>Data1</i>	8 Bits	7 – 8 Bits (2 Selections)	Comm 1 Data Bits	43
P202.00	<i>Par 1</i>	None	None – Odd (3 Selections)	Comm 1 Parity	43
P203.00	<i>Stop1</i>	1 Bit	1 – 2 Bits (2 Selections)	Comm 1 Stop Bits	43
P204.02	<i>HndS1</i>	Soft	None – Both (4 Selections)	Comm 1 Handshake	43
P210.01	<i>Send1</i>	Press	Off – ID (5 Selections)	Comm 1 Transmit	43
P212.01	<i>Stbl1</i>	Delay	Off – Delay (Toggle)	Comm 1 Motion	44

Parameter Number	Display Name	Default Value	Valid Range/ Choices	Parameter Description	Page
P213.01	<i>Ttyp1</i>	--1--	1 – 16, Custom (Selection)	Print Transmission	44
P220.00	<i>Baud2</i>	9600	150 – 115K (13 Selections)	Comm 2 Baud Rate	44
P221.01	<i>Data2</i>	8 Bits	7 – 8 Bits (2 Selections)	Comm 2 Data Bits	44
P222.00	<i>Par 2</i>	None	None – Odd (3 Selections)	Comm 2 Parity	44
P223.00	<i>Stop2</i>	1 Bit	1 – 2 Bits (2 Selections)	Comm 2 Stop Bits	44
P224.02	<i>HndS2</i>	Soft	None – Soft (2 Selections)	Comm 2 Handshake	44
P230.01	<i>Send2</i>	Press	Off – ID (5 Selections)	Comm 2 Transmit	43
P232.01	<i>Stbl2</i>	Delay	Off – Delay (Toggle)	Comm 2 Motion	44
P233.01	<i>Ttyp2</i>	--1--	1 – 16, Custom (Selection)	Print Transmission	44
P260.00	<i>Type</i>	350 I.S.	350 I.S. – Cntrl (4 Selection)	Remote Display Type	44
P290.00	<i>Echo</i>	None	None – Port 2 (3 Selections)	Remote Display – Master Echo	44
P291.02	<i>Start</i>	<STX>	0 – 255 (256 Selections)	Master Display Start Character	45
P292.03	<i>End</i>	<ETX>	0 – 255 (256 Selections)	Master Display Ending Character	45
P296.00	<i>EStyle</i>	300	300 or 60 (2 Selections)	Remote Display Style Echo Format	45
P410.--	<i>Euro</i>	Disable	Enable / Disable 9991/9990 (Key In)	OIML Enforce	45
P412.--	<i>PrSEt</i>	Disable	Enable / Disable (Toggle)	OIML Enforce	45
P420.01	<i>Dsply</i>	On	Off – Auto (3 Selections)	Display Function	45
P423.00	<i>Light</i>	Off	ON/OFF (Toggle)	Backlight	45
P427.00	<i>Apo</i>	Off	Off – 60 minutes (16 Selections)	Auto Power for Battery Option	45
P440.00	<i>rStrc</i>	Disable	Enable / Disable (Toggle)	NTEP Enforce	45
P500.--	<i>Tine</i>	12.00.00	(Keyed In)	Time/Date Function	46
P501.--	<i>Date</i>	01.01.70	(Keyed In)	Time/Date Function	46
P502.01	<i>disbl t-dAt</i>	Disable	Enable / Disable (Toggle)	Time/Date Function	46
P503.01	<i>12 hours</i>	12 hour	12 hour/24 hour	Time/Date Function	46
P504.00	<i>Style</i>	U.S.A	U.S.A or International	Time/Date Function	46
P505.01	<i>TdSEL disbl</i>	Disable	Enable / Disable (Toggle)	Time/Date Function	46
P800.00	<i>But1</i>	None	None – Print/Tare (5 Selections)	Remote Button Function	46
P801.00	<i>But2</i>	None	None – Print/Tare (5 Selections)	Remote Button Function	46
P1000.--	<i>Cust.tran1</i>	--	--	Custom Transmit 1	46
P2000.--	<i>Cust.tran2</i>	--	--	Custom Transmit 2	47
P5000.00	<i>TArGi</i>	Disable	Enable / Disable (Toggle)	Target Key	47
P5002.00	<i>StoP</i>	Disable	Enable / Disable	Stop Key	47



Parameter Number	Display Name	Default Value	Valid Range/ Choices	Parameter Description	Page
			(Toggle)		
P5003.00	StArt	Disable	Enable / Disable (Toggle)	Start Key	47
P5004.00	Chec	Auto	Auto / Start (Toggle)	355 Restart Mode	47
P5010.00	SPAnn	Enable	Enable / Disable (Toggle)	Setpoint Annunciators	47
P5011.00	SPBar	Disable	Enable / Disable (Toggle)	Bargraph Display	47
P5012.00	BarPc	50%	0 – 100 (Key In)	Bargraph Scaling	47
P5100.00	SetPt	None	None – ChecB (9 Selections)	Setpoint Operation	47

Parameter Map Details

P110 Full Scale Value (Key in)

Denotes the full scale capacity. This value should not exceed the rated capacity of the weighing device.

P111 Division Size (Selection)

Indicates the count-by and decimal point. Pressing  +  (Model 350 I.S.) or  (Model 355 I.S.) will automatically select the choice closest to 10,000 divisions without exceeding 10,000 divisions.

P112 Zero Track Aperture (Selection)

Set in terms of number of divisions. Zero tracking eliminates small weight deviations at or near zero. Weight deviations within the selected window that have been stable for more than one second are tracked off, maintaining a gross or net zero condition.

The sum of weight values zeroed with auto zero tracking and  cannot exceed the allowable zero range (P118).

To determine the proper setting in a counting application, divide the weight of the smallest product counted by the division size (P111). Zero Track should be set to 0 (off) for most setpoint filling operations. This prevents tracking off any product trickle at the start of a fill process.

P114 Stability (Selection)

Stability is defined as weight fluctuations within an aperture that can be regarded as being a stable weight. Deviations outside this aperture are considered motion, and the motion annunciator on the front panel will light accordingly. Once the scale settles within the stability aperture, the indicator will wait for a period of time specified by the motion delay (P115) before the indicator is considered stable.

Print operations configured as motion delayed (P114) will not send the specified data until the weight reflects a stable reading as designated by this setting. Certain setpoint operations are also considered motion delayed and will not change states until a no-motion condition exists.

P115 Stability Delay (Selection)

Selects the stability (motion) time delay to a resolution of 0.1 seconds. For example, an entry of 25 will be accepted as 2.5 seconds.

P116 Filter (Selection)

Sets the indicator response time in terms of seconds. Filtering determines how quickly the indicator will respond to changing input signals. A low filter setting speeds the response, a higher filter setting will ‘dampen’ the response.

Filtering is used to filter out weight fluctuations caused by outside sources, such as vibrations or air currents.

P117 Rate (Selection)

Specifies how often the display is updated with new data and the rate of continuous transmits (if P210 or P230 are enabled). For example, if 0.05 is selected, the controller will write data to the display and send continuous transmits 20 times a second. Selections from 0.05 to 20.0 seconds are available. The actual rate may be less than (P117). The actual rate depends on the indicator speed (P60090), the size and number of transmits (P1000, P2000, P210, and P230), and COM ports’ speed (if echo (P290) is enabled or continuous transmits are enabled).

P118 Zero Range (Selection)

Specifies how many divisions can be zeroed in terms of a **percentage** of full scale (P110). The sum of weight values zeroed through the  key and auto zero tracking cannot exceed this range.

A zero range of 5% is commonly used with large tank scales to avoid accidental zeroing of a full or partially full tank.

P119 Multi-Point Linearization (Toggle)

Enable the five-point linearization feature used during load cell calibration.

P150 Units (Toggle)

Set default units to ‘lb’ or ‘kg’. The indicator must use the default units during calibration procedures (see *Chapter 4*). The default units are the displayed units upon indicator power-up.

P151 Units Button (Toggle)

When enabled, this parameter will allow  to toggle the units between ‘lb’ and ‘kg’ (1000g). When disabled, the indicator will show only the calibration units as determined by P150.

P152 Third Unit (Selection)

This parameter will allow the choice of three additional units (ounces, grams or lb oz) that may be accessed with the  key. Only one unit will be available at a time. The third unit can only be selected if P151 is enabled. The third unit will be identified by an annunciator on the display. This unit selection is not legal for trade.

P161 Tare Save (Toggle)

Enabling Tare Save allows the indicator to retain the tare value in the event of power loss. The correct net weight is restored upon power-up.



P166 Auto Tare (Toggle)

When enabled, pressing  will wait for a no-motion condition and then bring the scale to a net zero reading. Disabling will prevent keypad tare operations.



Note that if a setpoint activation method is set to , disabling Auto Tare will also disable the activation of that setpoint.

P167 Keyboard Tare (Toggle)

If P167 is disabled, then the user cannot view tare using the select key. Also, it will block numeric tare (manually entering tare) and show a msg "Funcnt" "disbl". Only way you can tare is using the automatic tare (press  to tare the weight on the scale). When P167 is on, the user can view tare using the select key (tare will follow Net). The unit will accept numeric tare. On the Model 355, users can use the numeric keypad. On the Model 350, users can use  and  to scroll in an entry.

P169 Auto Tare Clear (Toggle)

Enabling this feature will cause the current tare value to be cleared to zero every time the indicator stabilizes within ± 5 graduations of gross zero

P171 Analog (Toggle)

Enable or disable the optional analog output module. See *Analog Output Setup* on page 82 for all parameters associated with the Analog Output Module.

P179 Count (Toggle)

When enabled, the quantity mode becomes accessible via the  key. The quantity mode is identified by the illumination of the QTY annunciator.

P200 Baud (Comm 1) (Selection)

Set the desired baud rate for the communication port. 150 – 115K bps

P201 Data Bits (Comm 1) (Toggle)

Select 7 or 8 data bits for the transmission.

P202 Parity (Comm 1) (Selection)

Select *Odd*, *Even* or *None* for the transmission parity.

P203 Stop Bits (Comm 1) (Toggle)

Select 1 or 2 stop bits for communication port transmissions.

P204 Comm Handshake (Comm 1) (Selection)

Select from *None*, *Software (Xon/Xoff)*, *Hardware (CTS/RTS)*, or *Both*.

P210 Send (Comm 1) (Selection)

Transmission Send options:

Choice Number	Selection Name	Description
P210.00	<i>Off</i>	All transmissions disabled.
P210.01	<i>Press</i>	Sends transmission with  key.
P210.02	<i>Cont.</i>	Sends transmissions continuously.
P210.03	<i>Cycle</i>	Send single transmission after weight is reached and motion ceases. Must return display value below 0.1% of F.S. to reset for next transmission.
P210.04	<i>ID</i>	Sends transmission with the stored ID.

P212 Send Stability (Comm 1) (Toggle)
Enabling Send Stability will delay any transmissions until a no-motion condition exists.

P213 Transmit Selection (Comm 1) (Selection)
Select desired print output (1 – 16 or custom). The transmission will be initiated by the selected print operation (P210) and / or the Remote Key selection (P800). See page 48 for details on preset formats or page 50 for details on custom transmit.

P220 Baud (Comm 2) (Selection)
Set the desired baud rate for the communication port. 150 – 115K bps

P221 Data Bits (Comm 2) (Toggle)
Select 7 or 8 data bits for the transmission.

P222 Parity (Comm 2) (Selection)
Select *Odd*, *Even* or *None* for the transmission parity.

P223 Stop Bits (Comm 2) (Toggle)
Select 1 or 2 stop bits for communication port transmissions.

P224 Comm Handshake (Comm 2) (Selection)
Select from *None and Software*.

P230 Send (Comm 2) (Selection)
Transmission Send options:

Choice Number	Selection Name	Description
P230.00	<i>Off</i>	All transmissions disabled.
P230.01	<i>Press</i>	Sends transmission with  key.
P230.02	<i>Cont.</i>	Sends transmissions continuously.
P230.03	<i>Cycle</i>	Send single transmission after weight is reached and motion ceases. Must return display value below 0.1% of F.S. to reset for next transmission.
P210.04	<i>ID</i>	Sends transmission with the stored ID.

P232 Send Stability (Comm 2) (Toggle)
Enabling Send Stability will delay any transmissions until a no-motion condition exists.

P233 Transmit Selection (Comm 2) (Selection)
Select desired print output (1 – 14 or custom). The transmission will be initiated by the selected print operation (P210) and / or the Remote Key selection (P800). See page 48 for details on preset formats or page 50 for details on custom transmit.

P260 Master, Remote Display or Safe Area Hub (Selection)
Select the mode of operation.

Choice Number	Selection Name	Description
P260.00	<i>350 I.S. / 355 I.S.</i>	Sets indicator as the master device.
P260.01	<i>R-dsp</i>	Sets the indicator as a slave device. P261 – P283 will be available.
P260.02	<i>Hub</i>	Sets the indicator to a safe area hub.
P260.03	<i>Cntrl</i>	Sets the indicator to the master controller for fiber-optic interface to the safe area hub.

P290 Echo Display (Toggle)
Determines which comm. port will be echoed to another device. Selections are None, port 1, port 2.

P291 Start Character (Key-in)
Set the start character for the master indicator. Choices are 0 – 255. Default value is 2 (STX). The choice must match the start character at P274 of the remote display (slave). A value of 0 means that a byte with the value 0 will be sent for the character. Avoid using values of 17 or 19 when using software flow control. The values of 17 and 19 are Xon and Xoff codes and could cause conflict.

P292 End Character (Key-in)
Set the end character for the master indicator. Choices are 0 – 255. Default value is 3 (ETX). The choice must match the end character at P275 of the remote display (slave). A value of 0 means that a byte with the value 0 will be sent for the character. Avoid using values of 17 or 19 when using software flow control. The values of 17 and 19 are Xon and Xoff codes and could cause conflict.

P296 Echo Style (Toggle)
Set the style of indicator the display will be echoed to. Choose from *300* or *60*. The *300* choice is for 350, 355, 350 I.S., 355 I.S., 351, ABS 4100. The *60* choice is for 460 series, 560 series and 660 series indicators.

P410 Euro (Toggle)
Enable OIML legal-for-trade restrictions (see Chapter 5: Legal For Trade).

P412 Preset Character (Toggle)
If P412 is enabled, it will add a ‘P’ to the beginning of the tare parameter on the display and transmits if the last tare value was entered manually by the user (numeric entry). P167 needs to be enabled in order to key in a tare value. A ‘P’ will not be added if the last tare was performed by pressing the tare key or if the tare value is zero (even if the zero value was manually entered by the user). The ‘P’ prefix stands for “Preset”. When P412 is disabled, the unit will never show 'P' before tare no matter how tare is entered.

P420 Display (Selection)
Select display control option. Choose from *On*, *Off* or *Auto*. The auto setting helps conserve power for extended battery life. When the indicator display is off, the load cell(s) are still powered.

If P420 is set to *Off* or selection 0, you can turn on the display by holding down the ZERO key upon power up. This does not set P420 to *On*; it only temporarily turns on the large VFD display in order to allow you to see what you are entering.

Parameter Setting	Choice	Description
P420.00	<i>Off</i>	Shuts off the display.
P420.01	<i>On</i>	Normal display operation.
P420.02	<i>Auto</i>	Shuts off the display when weight has stabilized within 6 divisions for 5 minutes. Pressing [ON] or changing weight more than 6 divisions will re-enable the display. NOTE: The display will turn back on if data is received via the RS-232 Port.

P423 Back Light (on/off)
Toggle the backlight on a Model 350/355 I.S. LCD.

P427 Battery Option Automatic Shutdown (Selection)

Select duration of time for auto shutdown. Choose from selections with the  key. Selections are off, 0.5, 1, 2, 3, 4, 5, 10, 15, 20, 25, 30, 35, 40, 45, and 60. Choices are in set in minutes.

- P440 Legal For Trade Restrictions (Toggle)**
Enable NTEP legal-for-trade restrictions. See Chapter 5: Legal For Trade.
- P500 Time Setting (key in)**
Enter the time in the form HH.MM.SS. Time is always shown in military format within this parameter. P503 will determine how the time is displayed in the weigh mode.
- P501 Date Setting (key in)**
Enter the date in the form MM.DD.YY. P504 will determine the how the date is displayed in the weigh mode.
- P502 Time/Date (toggle)**
Enables or disables the time and date feature. If enabled the time and date will be accessible from the weigh mode with the  key. The weight will continue to be updated when viewing the time or date. The time will be formatted as defined by P503 and the date will be formatted as defined by P504. See page 77 for instructions on how to change the time and/or date.
- P503 Hours (toggle)**
Determines the TIME format style, 12 hour or 24 hour. If in 12 hour mode the right most decimal point on the display will become the PM indicator. Note: The time must be entered as military time. If the mode is set for 12 hour, the time will be converted to a 12 hour clock.
- P504 Style (toggle)**
Determines the DATE format style, U.S.A. or Int'l. If set for U.S.A, the date will resemble 01/26/01. If set for international, the date will resemble 26/01/01.
- P505 Time/Date Select (toggle)**
Enables or disables the editing of time and date the weigh mode.
- P800 Remote Key 1 Operation (Selection)**
Select function for Remote Key closure. Choose from *None, Print, Tare, Zero or Print/Tare*. If a setpoint is configured to use the remote key as an activation method, then the P800 setting is over-ridden. The *Remote Key Operation* section on page 80 details the remote key operation. See *Remote Key Connection* on page 18 for remote key electrical connections.
- P801 Remote Key 2 Operation (Selection)**
Select function for Remote Key closure. Choose from *None, Print, Tare, Zero or Print/Tare*. If a setpoint is configured to use the remote key as an activation method, then the P801 setting is over-ridden. The *Remote Key Operation* section on page 80 details the remote key operation. See *Remote Key Connection* on page 19 for remote key electrical connections.
- P1000 Custom Transmit 1**
A custom transmit is a user-defined string of data that can be sent to the serial port. Parameter P1000 is the beginning of the custom transmit table for transmit 1 and must be enabled for transmit by selecting *cust* at P213. Parameters use three bytes of memory;

ASCII characters and control codes use one byte. See P60001 for available memory. The custom transmit cannot be viewed or altered from the indicator. A custom transmit *must* be entered via the serial port. See *Custom Transmit Setup* on page 50 for details on designing and loading a custom transmit.

P2000 Custom Transmit 2

A custom transmit is a user-defined string of data that can be sent to the serial port. Parameter P2000 is the beginning of the custom transmit table for transmit 2 and must be enabled for transmit by selecting *cust* at P230. Parameters use three bytes of memory; ASCII characters and control codes use one byte. See P60001 for available memory. The custom transmit cannot be viewed or altered from the indicator. A custom transmit *must* be entered via the serial port. See *Custom Transmit Setup* on page 50 for details on designing and loading a custom transmit.

P5000 Target Key (Toggle)

Allows a target value to be entered or viewed. Sending a % <CTRL-A> using a serial device such as a computer is equivalent to pressing the Target key.

P5002 Stop Key (Toggle)

Enable or disable the use of the stop key from the 355 keypad. Pressing the stop key in the gross, net, tare, APW or quantity modes with setpoint(s) enabled will cause all setpoints to deactivate and pause. Sending a % <CTRL-F> using a serial device such as a computer is equivalent to pressing the Stop key.

P5003 Start Key (Toggle)

Enable or disable the use of the start key from the 355 keypad. Pressing the Start key in the gross, net, tare, APW or quantity modes with setpoints enabled causes a paused setpoint operation to be resumed. Sending a % <CTRL-E> using a serial device such as a computer is equivalent to pressing the Start key.

P5004 355 Restart Checkweighing Mode (Toggle)

Determines the method in which the checkweighing mode will be restarted. Auto will restart after return to zero or Manual will restart by pressing the  key. If Stop (P5002) is disabled, this function is disabled and parameter 5004 will not appear.

P5010 Setpoint Annunciators (Toggle)

Enables or disables the setpoint annunciators to the left of the main 7-segment display. Disabling the setpoint annunciators may be desired when the bargraph is enabled while using an LCD display. See *Bargraph* on page 59.

P5011 Setpoint Bargraph (Toggle)

Enables or disables the bargraph display on the LCD version of the Model 350/355 display. This setup parameter only appears if an LCD display is installed. See *Bargraph* on page 59.

P5012 Setpoint Bargraph Low-Limit Percentage (Key in)

Controls the "bargraph low-limit percentage" value for determining the *weighting* of each segment of the bar graph. This only appears if an LCD display is installed. See *Bargraph* on page 59.

P5100 Setpoint Operation (Selection)

Sets the desired Setpoint operation. Choose between *None*, *ChecP*, *Fill*, *Batch*, *Discharge*, *Both*, *ChecA* or *Independent*. See *General Setpoint Setup* on page 56 for complete details on setpoint setup and operation.

Preset Transmit Selections

The Model 350 I.S. and Model 355 I.S. provide 14 preset formats for printing tickets or sending data to a computer. Only one format or custom transmit may be enabled at a time.

Choice 0 Custom Transmit:

User-defined serial data string (see *Custom Transmit Setup* on page 50).

Choice 1 GSE Standard Transmit:

```
HH:MM:SS am MM/DD/YY <CR><LF>
XXX.XX kg Gross<CR><LF>
XXX.XX kg Tare <CR><LF>
XXX.XX kg Net <CR><LF>
```

Choice 2 Count:

```
HH:MM:SS am MM/DD/YY <CR><LF>
  XXX QTY <CR><LF>
  XX.X kg APW <CR><LF>
XXX.XX kg Gross<CR><LF>
XXX.XX kg Tare <CR><LF>
XXX.XX kg Net <CR><LF>
```

(NOTE: *The time and date will only be printed in choice 1 and 2 if P502 is enabled).*

Choice 3 (Condec Clone):

```
<STX> <POL> <DATA> <L/K> <G/N> <STAT> <CR> <LF>
```

Where:

<STX> is a single control code, decimal value of 2.

<DATA> is 8 characters, 1st character is either minus sign or a space, padded with leading spaces, with an embedded decimal point.

<L/K> is a single 'L' or 'K' character to indicate lb or kg units.

<G/N> is a single 'G' or 'N' character to indicate gross or net data.

<STAT> is an 'O' (overload/underload), 'M' (motion), or space otherwise.

<CR> is a single control code (carriage return), decimal value of 13.

<LF> is a single control code (line feed), decimal value of 10.

Choice 4:

```
<STX><SignedDATA><sp><lb/kg><sp><Gross/Net/Qty><STAT><CR>
```

Choice 5:

```
<STX><Signed DATA><sp><lb/kg><STAT><CR>
```

Choice 6:

```
<STX><Signed DATA><sp><lb/kg><CR>
```

Choice 7:

```
<STX><Unsigned DATA><sp><CR>
```

Choice 8:

```
<STX><Signed DATA><sp><lb/kg><sp><Gross/Net/Qty><STAT><SPS><CR>
```

Choice 9:

```
<STX><Signed DATA><sp><lb/kg><STAT><SPS><CR>
```

Choice 10:

```
<STX><Signed Displayed Weight><sp><lb/kg><SPS><CR>
```

Choice 11:

```
<STX><Unsigned Displayed Weight><SPS><CR>
```

Choice 12:

<STX><Unsigned DATA><sp><lb/kg><sp><Gross/Net/Qty><STAT><CR>

Use choice 12 to send to a 450/455/550 remote display that is set to text mode and a <CR> terminator.

Choice 13:

<STX><Unsigned DATA><sp><lb/kg><sp><Gross/Net/Qty><STAT> <CR><LF>

Choice 14 (Simulates NCI 3835):

<LF>Signed DATA<CR><LF><STAT><CR><ETX>

Data Block Name	Description
<STX>	A single control code, decimal value of 2.
<ETX>	A single control code, decimal value of 3.
<POL>	A <space> for positive data or a - for negative data.
<Signed DATA>	8 characters right justified, space padded, including a decimal point and polarity sign. Polarity is a '+' or '-' to the immediate left of the most significant digit.
<Unsigned DATA>	8 characters right justified, space padded, including a decimal point.
<lb/kg>	Two characters indicating pounds or kilograms.
<Gross/Net/PTY>	Single word for gross weight, net weight or quantity.
<STAT>	An 'O' (overload/underload), 'M' (motion), or <space> otherwise
<SPS>	See <SPS> Setpoint Status below.
<CR>	A single control code, decimal value of 13.
<LF>	A single control code, decimal value of 10.
<sp>	ASCII Space, decimal value of 32.

<SPS> Setpoint Status

Transmitting the setpoint status will reflect the current state of all the setpoints, regardless of which setpoint operation is configured. The status can be read as a single ASCII numeric character (0-7), a Hex value (30h-37h) or a binary bit comparison. Status is preceded by a <space> and an "S". The preceding data stream format is for fixed transmissions of <SPS> as specified above. This is not associated with the custom transmission of parameter P96.

SP 1	SP 2	SP3	ASCII	Hex	Bit Comparison
Off	Off	Off	0	30h	0011 0000
On	Off	Off	1	31h	0011 0001
Off	On	Off	2	32h	0011 0010
On	On	Off	3	33h	0011 0011
Off	Off	On	4	34h	0011 0100
On	Off	On	5	35h	0011 0101
Off	On	On	6	36h	0011 0110
On	On	On	7	37h	0011 0111

Choice 15 (RSD 3000):

<STX><G>< Signed DATA ><lb/kg><CR><LF>
<STX><SPS><CR><LF>

Choice 16 (RSD 3000):

<STX><N>< Signed DATA ><lb/kg><CR><LF>
<STX><SPS><CR><LF>



ID Number Entry and Printing

It is possible to enter an ID number and have the number print out on a ticket. This mode is accessed from the weigh mode by entering . The first six digits of the existing ID



number will be displayed. An alphanumeric ID of up to 50 characters can be entered. At this point a new ID number can be entered or the existing number may be cleared. In order for the ID number to be printed, the following criteria must be met.

- P210 or P230 must be set to *ID*. If the desired parameter(s) is set to another value, the indicator will not prompt for an ID entry.
- P213 or P233 must be set for *cust*. If the parameters are not set for custom, the ID will not be printed.
- P1000 or P2000 must contain parameter 21 (ID).

Enter an ID from the weigh mode:

1. Press the  key from the weigh mode. The display will show the current ID number if one has been entered previously.
2. Key in the desire ID number (numeric and/or alphanumeric) and press  (Model 350) or  (Model 355). This will print a ticket.

~or~

If the ID number shown is acceptable simply press  (Model 350) or  (Model 355). This will print a ticket.

Custom Transmit

The serial output of the Model 350/355 I.S. can be configured for a custom application such as a remote display format, a customized computer program format, or a customized ticket format. The custom transmit must be designed in a computer-transmittable ASCII text file. The custom transmit can only be loaded into the indicator through the serial port. P213 must be set to 0 to select the custom transmit format for COM1 transmission. P233 must be set to 0 to select the custom transmit format for COM2 transmission.

Elements Of A Custom Transmit

Parameters, ASCII text, and control codes are the elements of a custom transmit.

Parameters

Certain parameters related to weight, quantity, setpoints, ID and status could be sent out of the comm port. Gross Weight, Target 1 and Quantity are examples of printable parameters.

ASCII Text

ASCII text can be entered into a custom transmit to provide further detail of a transaction. “P”, “@” and “+” are examples of ASCII text.

Control Codes

You can custom transmit ASCII control codes to control a printing device. <CR> (carriage return) and <FF> (form feed) are examples of control codes. When entering a control code in a custom transmit table, use three digits preceded by a decimal point. Example: Start of Text

<STX> = 2. Key in .

Writing A Custom Transmit ASCII Text File

Any text editor may be used to construct a custom transmit (Notepad, Wordpad, etc.), but you must save the custom transmit as a text (.txt) file. Instructions can also be sent keystroke by keystroke from a communications program. To do so, ignore the Model 350/355 I.S. display and enter the characters in the correct order. Figure 20 shows a custom transmit written in Wordpad.

Access Setup And Clearing Existing Custom Transmit

Every custom transmit file must start with:

```
1999%s%s%z%p%u%e
%c%e
```

This accesses the Setup Mode at the end of the existing transmit and then clears the transmit so that a new one may be entered.

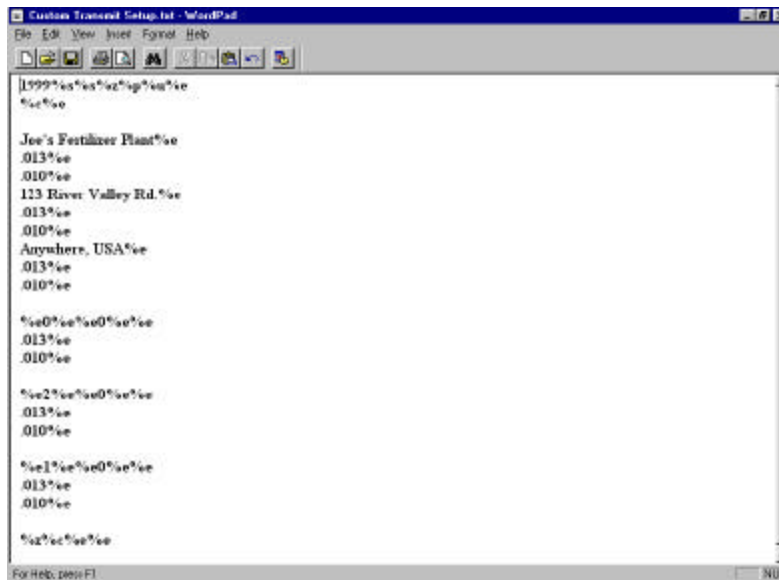

Figure 20: Custom Transmit File

Entering ASCII Text

ASCII text is defined as printable characters, including alpha-numerics as well as punctuation and symbols. See Table 2 for a complete listing of ASCII characters. ASCII text can be entered directly into a custom transmit with a %e (enter command). For example, **Joe's Fertilizer Plant%e**.

Entering ASCII Control Codes

Some ASCII characters are known as control codes, non-printable characters that instruct a printing device to perform certain functions. For example, a carriage return <CR> forces a printer to move the print head to the left-most position of the current line. A line feed <LF> forces the print head to move down one line. Enter control codes with a decimal point, a 3-digit ASCII code, and a %e. For example, **.013%e**.

Table 2: ASCII / HEXADECIMAL CONVERSION CHART											HEX	CHAR	DEC	
00	NUL	000	1A	SUB	026	34	4	052		N	078	68	h	104
01	SOH	001	1B	ESC	027	35	5	053	4F	O	079	69	i	105
02	STX	002	1C	FS	028	36	6	054	50	P	080	6A	j	106
03	ETX	003	1D	GS	029	37	7	055	51	Q	081	6B	k	107
04	EOT	004	1E	RS	030	38	8	056	52	R	082	6C	l	108
05	ENQ	005	1F	US	031	39	9	057	53	S	083	6D	m	109
06	ACK	006	20	SP	032	3A	:	058	54	T	084	6E	n	110
07	BEL	007	21	!	033	3B	;	059	55	U	085	6F	o	111
08	BS	008	22	“	034	3C	<	060	56	V	086	70	p	112
09	HT	009	23	#	035	3D	=	061	57	W	087	71	q	113
0A	LF	010	24	\$	036	3E	>	062	58	X	088	72	r	114
0B	VT	011	25	%	037	3F	?	063	59	Y	089	73	s	115
0C	FF	012	26	&	038	40	@	064	5A	Z	090	74	t	116
0D	CR	013	27	‘	039	41	A	065	5B	[091	75	u	117
0E	SO	014	28	(040	42	B	066	5C	\	092	76	v	118
0F	SI	015	29)	041	43	C	067	5D]	093	77	w	119
10	DLE	016	2A	*	042	44	D	068	5E	^	094	78	x	120
11	DC1	017	2B	+	043	45	E	069	5F	_	095	79	y	121
12	DC2	018	2C	‘	044	46	F	070	60	`	096	7A	z	122
13	DC3	019	2D	-	045	47	G	071	61	a	097	7B	{	123
14	DC4	020	2E	.	046	48	H	072	62	b	098	7C		124
15	NAK	021	2F	/	047	49	I	073	63	c	099	7D	}	125
16	SYN	022	30	0	048	4A	J	074	64	d	100	7E	~	126
17	ETB	023	31	1	049	4B	K	075	65	e	101	7F	DEL	127
18	CAN	024	32	2	050	4C	L	076	66	f	102			
19	EM	025	33	3	051	4D	M	077	67	g	103			



Most printers require a carriage return (.013) and/or a line feed (.010) to print preceding data and avoid leaving data in the printer buffer.

Parameter Selection Numbers

The following sequence enters parameters into a custom transmit: **%e** , the parameter number, **%e%e** , a format code, and then **%e%e** with no intervening spaces.

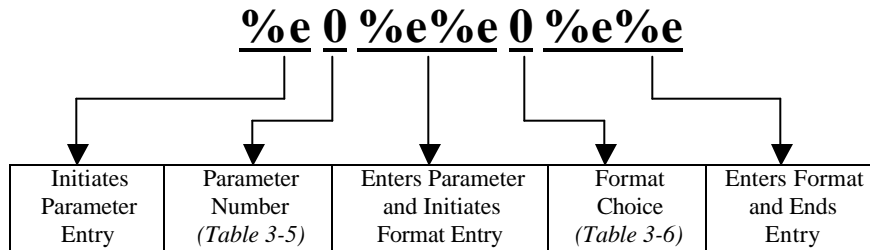

Table 3: Custom Transmit Parameter Selection Numbers

Parameter Name	Parameter Number	Sample Print Output
Gross Weight	0	27.49 lb Gross
Net Weight	1	14.53 lb Net
Tare Weight	2	12.96 lb Tare
Time / Date	11	10:01:01 am 01/26/01
ID	21	ID: 12MN53
Quantity	30	58 Qty
APW	34	0.25 lb APW
APW * K	35	250 lb APW * K
Targ1	60	400 lb Targ1
Targ2	64	500 lb Targ2
Targ3	66	1000 lb Targ3
Act 1 (note: Indp. SP1)	70	600 lb Act 1
Rst 1 (note: Indp. SP1)	71	10 lb Rst 1
Act 2 (note: Indp. SP2)	72	300 lb Act 2
Rst 2 (note: Indp. SP2)	73	10 lb Rst 2
Act 3 (note: Indp. SP3)	74	100 lb Act 3
Rst 3 (note: Indp. SP3)	75	5 lb Rst 3
Setpoint Status	96	Setpt 0
Stability Status	97	Stat M
Displayed Value	98	16.34 lb Gross

The default format code for all parameters is 0. This prints all numeric data with 8 characters, right justified, left spaces filled., the units (if applicable) and the parameter name. The format choices for all parameters (except Stability Status and Setpoint Status) are shown in Table 4.

Table 4: Custom Transmit Format Codes

Choice	Sample Print Result	Description
Weight Parameter Format Codes		
0	“ 27.49 lb Gross”	Fixed width (8 characters), right justified, left spaces filled.
1	“000027.49 lb Gross”	Fixed width (8 characters), right justified, left zeroes filled.
2	“27.49 lb Gross”	Fixed width, left justified, right spaces filled.
3	“27.49 lb Gross”	Minimum possible width.
8	“400. lb Net”	Print decimal point, even if data has no fractional portion.
16	“+400 lb Net”	Print “+” for positive numbers.
32	“336.52 Net”	Do NOT print parameter units (lb or kg).
64	“336.52 lb Net”	Print value in “default” units (as opposed to current viewed units).
128	“336.52 lb”	Do NOT print parameter name. Only Format Code that applies to ID

Time/Date Format Codes		
1	“10:07:40 am 01/26/01”	Includes seconds with time.
2	“10:08 01/26/01”	24 hour time format.
4	“10:11 am Jan 26, 2001”	Print date spelled out.
8	“10:12 am Fri 01/26/01”	Print day of the week.
16	“10:12 am 26/01/01”	International date format.
32	“980503984 Tm/Dt”	# of seconds since 12:00 AM Jan 1, 1970.
64	“01/26/01”	Do NOT print time.
128	“10:14 am”	Do NOT print date.

If a combination of format choices is required, add the choice numbers together and enter their sum as the format code. For example, to print the net weight without the name (Net) or units (lb) and to print it minimum width:

NOTE: Only one of the choices 0-3 may be used at one time.

Choice	Sample Print Result	Description
3	“336.52 lb Net”	Minimum possible width.
32	“336.52 Net”	Do NOT print parameter units.
128	“336.52 lb”	Do NOT print parameter name.
Use the sum of the desired choice selections: $3 + 32 + 128 = 163$		
163	“336.52”	Minimum possible width. Do NOT print parameter units. Do NOT print parameter name.

Exiting Setup Mode And Saving Changes

Each custom transmit file must end with:

%z%c%e%e



This exits the Setup Mode, bypasses the calibration procedure and saves the indicator configuration file.

Parts Counting



The counting parameter must be enabled before the quantity mode is available. Refer to page 43 for details on the counting parameter and page 32 to enter the setup mode, make changes and save the change.

To sample using selectable fixed counts (350 I.S.):





- From the Weigh Mode, Press to view the current net weight.
DISPLAY READS ► 1.05
- Press until the QTY annunciator is lit. The display may show **do APS** if there is no APW.
DISPLAY READS ► 0
- Press to perform an auto-tare. The scale prompts to add 10 pieces.
DISPLAY READS ► Add ~ 10

4. Press  to toggle sample amounts between 5, 10, 20, 50 and 100.
DISPLAY READS ► Add ~ 20
5. Add the pieces to be sampled and press  to sample and display the current quantity.
DISPLAY READS ► 20



To sample using selectable fixed counts (355 I.S.):

1. Press  to perform an auto-tare. The scale prompts to add 10 pieces.
DISPLAY READS ► Add ~ 10
2. Press  to toggle sample amounts between 5, 10, 20, 50 and 100.
DISPLAY READS ► Add ~ 20
3. Add the pieces to be sampled and press  to sample and display the current quantity.
DISPLAY READS ► 20

To sample using variable counts (350 I.S.):

1. From the Weigh Mode, Press  to view the current net weight.
DISPLAY READS ► 1.05
2. Press  to view the current quantity/count.
DISPLAY READS ► 0
3. Press  to perform an auto-tare. The scale prompts to add 10 pieces.
DISPLAY READS ► Add ~ 10
4. Add pieces, key in **36**, then press  to sample as 36 pieces and display the current quantity.
DISPLAY READS ► 36

To sample using variable counts (355 I.S.):

1. Press  to perform an auto-tare. The scale prompts to add 10 pieces.
DISPLAY READS ► Add ~ 10
2. Add pieces, key in **36**, then press  to sample as 36 pieces and display the current quantity.
DISPLAY READS ► 36

Setpoint Setup

The Model 350/355 I.S. has several pre-programmed scale setpoint applications available at P5100. Various related setpoint parameters may appear according to which of the standard programs is chosen. Table 5 describes the available setpoint operations.



Table 5: Setpoint Operations

Setpoint Selection	Function	Description	Page Ref
P5100.00	<i>None</i>	Setpoints disabled.	
P5100.01	<i>ChecP</i>	Percentage check-weighing. Over/Under tolerances are based on a percentage of the target weight.	62
P5100.02	<i>Fill</i>	Single Ingredient Fill (Single or Dual-Speed). Allows the use of pre-acts for dribble feed and compensation for free-fall material. Includes a selectable 'learn' mode.	63
P5100.03	<i>Batch</i>	Batch up to three ingredients. Allows for the use of pre-acts to compensate for free-fall material. Includes selectable 'learn' modes.	65
P5100.04	<i>Dschg</i>	Single Ingredient Discharge (Single or Dual-Speed). Allows the use of pre-acts for dribble feed and compensation for free-fall material. Includes a selectable 'learn' mode.	67
P5100.05	<i>Both</i>	Single Ingredient Fill and Discharge. Fill large holding vessels and discharge material in pre-determined amounts. Allows for the use of pre-acts to compensate for free-fall material. Includes a selectable 'learn' mode.	69
P5100.06	<i>ChecA</i>	Absolute check-weighing. Over/Under tolerances are based on discrete values.	71
P5100.07	<i>Indep</i>	Independent Setpoints. Activation based on specific target values. Includes selectable reset conditions.	73
P5100.08	<i>Checb</i>	Target Deviation check-weighing. Over/Under tolerances are deviated from the target weight.	75

Each program utilizes the three annunciators located to the left of the main display to give a visual status of the setpoint. A setpoint option board may be installed in the safe area via Fiber-Optic hub to allow control of an external device.

Activation Methods (General)

Setpoint activation for Fill, Batch, Discharge, and Both can be initiated in one of four ways: Tare, Remote, Auto and Start key (355 I.S. only). Check-weigh operations have no start function but there are two methods of restarting. See parameter 5004 on page 47 for more details. Independent setpoint operations are limited to Above or Below activation. The Model 350 I.S. and Model 355 I.S. setpoint option board may be connected in-series with a larger automated control system or a manually activated switching device. A foot switch, a two-hand safety station, or other permissive-start devices may be used for safety or system compatibility.

Activation Method (P5003)	Description
Tare Operation	The  activates the setpoint. It waits for a no-motion condition, then tares scale to net zero. The appropriate setpoint is then activated.
Remote Key 1 (START key) 355 I.S. only	The  key activates the setpoint. The remote key function (assigned at P800) is overridden . A setpoint and P5003 must be enabled for the start key to operate.
Remote Key 2 (STOP key) 355 I.S. only	The  key activates the setpoint. The remote key function (assigned at P801) is overridden . A setpoint and P5002 must be enabled for the start key to operate.
Auto-Start	Automatically activates the setpoint after motion ceases.

Pre-Acts (General)

Pre-Acts are control actions prior to reaching a desired target value. Necessary to prevent over-filling due to product flow rate, relay and valve response time and product suspension, Pre-Acts compensate for other system variables affect how much *more* product reaches the weighing device after the indicator has deactivated a setpoint.

Pre-act 1

Used in dual-speed applications, pre-act 1 specifies when the Model 350/355 I.S. should switch from fast-fill to slow-fill, allowing the system to perform the bulk of a filling operation as quickly as possible before switching to a more manageable dribble mode for final cutoff. When using a single-speed device, set pre-act 1 to 0.

Pre-act 2

Specifies the weight where the final cutoff should occur, enabling the Model 350/355 I.S. to compensate for a dispensing control's closure time and account for free-fall material. Free-fall is the amount of product that has passed the point of the dispensing control yet not yet reached the weighing device.

Pre-act values are entered in terms of the amount of product that would over-fill or 'how early' to close the control device. For instance, after repeated tests, a system consistently over-fills by .5 lbs. This is the value that should be entered as the pre-act. The Model 350/355 I.S. would then deactivate the setpoint .5 lbs. less than the desired final target value.

Parameter Setting	Actual Cutoff Value	Comments
Target = 400 lbs.		Desired final weight.
Pre-Act 1 = 28	$400 - 28 = 372$	Switch to slow feed at 372 lbs.
Pre-Act 2 = .5	$400 - 0.5 = 399.5$	Final fill valve closes at 399.5 lbs.

Learn Feature (General)

The Model 350/355 I.S. can 'learn' optimal pre-act values. When enabled, the learn feature will automatically adjust the final cutoff value based on an analysis of the five previous fills, helping achieve a final target by compensating for product viscosity, changes in plant air pressures, sticky valves, etc. For each cycle, the prior five final weights are analyzed and a new pre-act value is calculated.

Pause Feature (General)

The Model 350/355 I.S. can pause setpoint operations. This is useful to provide a pause for mid-cycle operator breaks, mechanical adjustments, etc.

Pause Setpoints on the Model 350 I.S.





When invoked, Pause deactivates all setpoints. The display will show: **Tare= ~ Abort**. Pressing



will abort the current cycle; any other keypress will resume the cycle. The Pause feature has four settings:



Pause Setting	Action	Result
Disabled		Pause feature disabled.
Keypad	Model 350/355 I.S. Key Press	Current cycle paused – all setpoints deactivated.
Remote Key	Remote Key Contact Closure	Current cycle paused – all setpoints deactivated.
Both	Model 350/355 I.S. Key Press OR Remote Key Contact Closure	Current cycle paused – all setpoints deactivated.



Pause Setpoints on the Model 355 I.S.





When invoked, Pause deactivates all setpoints. Pressing the  key will pause the setpoints. The display will show: *Abort ?Pause ~ Stop = Abort*. Pressing the  key again will abort the setpoints. Pressing the  key will resume all setpoints. In the independent setpoint mode, the setpoints will remain deactive until the  key is pressed.

Changing Targets From The Weigh Mode (General)

When a setpoint operation is configured from the Setup Mode, certain parameters are made available in the Weigh Mode. Pressing  cycles through available modes (Gross, Net, Quantity, Targ 1, etc.).

When viewing a setpoint-related parameter from the Weigh Mode,  takes on a special function. Data keyed in prior to  will be displayed as the new setpoint parameter value. Pressing  alone will advance to the first *subset* for the current setpoint parameter. Pre-acts and tolerances are subsets of their respective target values.

The Model 355 I.S. has a Target key to simplify the process of entering a target. Press the  and key in the target value and press .

A negative target value may be entered for the independent setpoints only. To enter the negative sign press  then  +  (Model 350 I.S.) or press  to display a negative sign (Model 355 I.S.). Continue with the entry by pressing the corresponding numeric keys.







Programs that involve a discharge cycle are loss-in-weight type applications. Any target or pre-act values for these programs should be entered as *positive* numbers. The Model 350/355 I.S. will automatically interpret these values as negative.

Change Target Weight Example (General)







The target for the fill setpoint operation is Targ 1. This is a setpoint-related parameter and automatically becomes an available mode when Fill is configured in the setpoint setup. Pre-act 1

and pre-act 2 are *subsets* of Targ 1. The following procedure illustrates how to change a target from 250 lbs to 400 lbs., keep pre-act 1 at 28 lbs. and change pre-act 2 from 1.5 lbs to .5 lbs.

To change targets from the Weigh Mode (350 I.S.):

1. Press .
DISPLAY READS ► 0.00
2. Press  to view the current fill target.
DISPLAY READS ► Targ1 ~ 250
3. Press **400**  to set a new fill target of 400 lbs.
DISPLAY READS ► Targ1 ~ 400
4. Press  to select the Pre-Act 1 (subset) value of 28 lbs.
DISPLAY READS ► PA 1 ~ 28
5. Press  to select the Pre-Act 2 (subset) value of 1.5 lbs.
DISPLAY READS ► PA 2 ~ 1.5
6. Press **.5**  to select a new Pre-Act 2 value of .5 lbs.
DISPLAY READS ► PA 2 ~ .5
7. Press  to display the current Gross Weight.
DISPLAY READS ► 15.12

To change targets from the Weigh Mode (355 I.S.):

1. Press  to view the current fill target.
DISPLAY READS ► Targ1 ~ 250
2. Key in the new target value and press . Example  
DISPLAY READS ► Targ1 ~ 100

Bargraph Setup (LCD)

A bargraph display is available for the ChecP, Fill, Batch, Dschg, Both and ChecA setpoint modes of operation. To enable the bargraph, refer to parameter P5011 (SPbar) in the *Parameter Map* section beginning on page 39. To weight each segment of the bargraph refer to parameter P5012 (bArPc) in the *Parameter Map* section beginning on page 39.

Scaling For "Bars" (Bargraph Arrows)

If the first bar turns off at the specified percentage (set at P5012) of the low limit, and the last bar turns off at the low limit, then the difference will be divided by 8 to determine the number of lbs per bar. At less than 5 grads, the entire graph is off.

Example#1: "ChecP" (refer to Figure 21)

- Lower Limit is set at 50lbs.
- **P5012** is set for **80%**

- **(Bar weight = 50 – 40 = 10)**
(10/8 = **1.25 lbs**)

NOTE: Right-side bars will have the same scaling (lb per bar) as the left-side bars. They are represented as a mirror image of each other.

<u>Bars ON</u>	<u>Weight Range (Lower Tolerance Limit)</u>
9	< 40
8	40.00 to 41.25
7	41.25 to 42.50
6	42.50 to 43.75
5	43.75 to 45.00
4	45.00 to 46.25
3	46.25 to 47.50
2	47.50 to 48.75
1	48.75 to 50.00

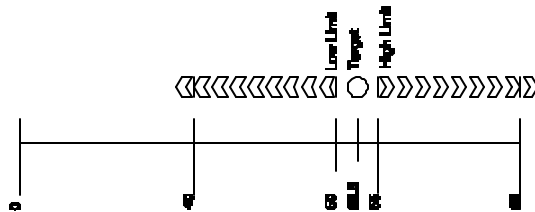

Figure 21: Example #1 Bargraph Segments (Weight Value)

Example#2: : “ChecP” (refer to Figure 21)

- Lower Limit is set at 50lbs.
- **P5012** is set for **20%**
- **(Bar weight = 50 – 10 = 40)**
(40/8 = **5 lbs**)

NOTE: Right-side bars will have the same scaling (lb per bar) as the left-side bars. They are represented as a mirror image of each other.

<u>Bars ON</u>	<u>Weight Range (Lower Tolerance Limit)</u>
9	< 10
8	10.00 to 15.00
7	15.00 to 20.00
6	20.00 to 25.00
5	25.00 to 30.00
4	30.00 to 35.00
3	35.00 to 40.00
2	40.00 to 45.00
1	45.00 to 50.00

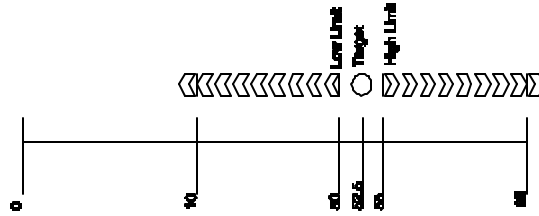

Figure 22: Example #2 Bargraph Segments (Weight Value)

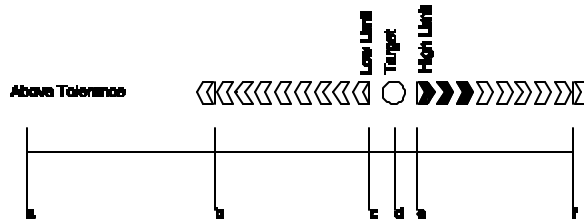
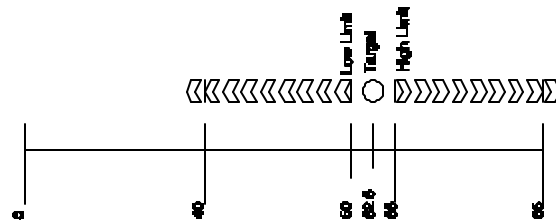
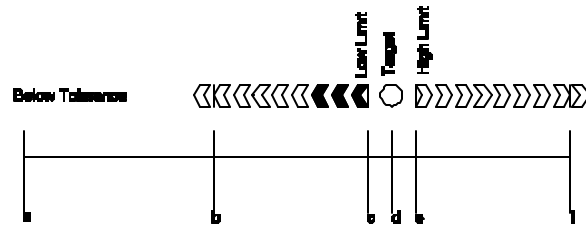

Figure 23: Examples of the Bargraph "Below, Within and Above Tolerance"

NOTE: (bargraph for filling and emptying modes)

For modes other than check-weighing, the bars will be on *only* while the setpoints are on and during the "Done" at the end of a fill.

The bar weights will be calculated similar to the check-weigh modes of operation stated above for filling, batching, etc., except that the percentage will be based on the actual target, rather than the low-limit value

(see the equation below). The operation for emptying (and the emptying portion of 'both') will be the same except that the weight will be going negative while the left side bars are turning off.

$$\text{Bargraph segment weight} = \frac{\text{Target} - \left(\left[\frac{(\% \text{ set at P5012}) \cdot \text{Target}}{100} \right] \right)}{8.5}$$



Although the setpoint annunciators are not motion-inhibited, the setpoint relay outputs will not activate until a no-motion condition exists.

Percentage Check-Weighing

This feature is commonly used in check-weigh applications. After a target weight is entered, upper and lower tolerances are entered as a percentage of the target. Over and under tolerance values are automatically calculated according to the percentages entered. The desired target may be based on gross weight, net weight or quantity (if counting is enabled). Only the annunciators will light to indicator the setpoint status. Physical setpoints cannot be added at this time. The setpoint modules will be available in the near future and will be installed in a safe area hub.

Table 6: Setpoint Setup (Percentage Check-Weighing)

Setpoint Selection	Function	Description
P5100.1	ChecP	Check-weigh by percentage.
P5101.--	Targ1	Absolute target value.
P5102.--	PctLo	Low acceptance percentage.
P5103.--	PctHi	High acceptance percentage.
P5104.0	Based	Select from <i>Net</i> , <i>Gross</i> or <i>Quantity</i> .

See *Key-In Parameters* on page 35 for instructions on using the front panel keys for entering data.

Setpoint Activation (Percentage Check-Weighing)

In order for the annunciators to activate, the displayed value must be at least five graduations above zero.

Check-Weigh Status	Annunciator Status	Annunciator Color (LED)
OVER	SP 1 Illuminated	Red
GOOD	SP 2 Illuminated	Green
UNDER	SP 3 Illuminated	Yellow









The Pre-Acts, Learn Mode, and Pause Feature options are not applicable to check-weigh operation.







Changing Targets From The Weigh Mode (Percentage Check-Weighing)

When Check-Weigh by Percentage is configured in the setpoint setup, the Targ 1 value automatically becomes an available mode for the key. It is possible to accept the applied weight as the target. Instead of keying in the target value from Targ 1, press (350 I.S.) or (355 I.S.). Press (350 I.S.) or (355 I.S.) again to accept the target. PctLo and PctHi are the subsets for Targ 1. PctLo and PctHi are entered as percentage values.

To change targets from the Weigh Mode (350 I.S.):

1. Press .
DISPLAY READS ► 0.00
2. Press  to view the current fill target.
DISPLAY READS ► Targ1 ~ 250
3. Press **400**  to set a new fill target of 400 lbs.
DISPLAY READS ► Targ1 ~ 400
4. Press  to select the Pre-Act 1 (subset) value of 28 lbs.
DISPLAY READS ► PA 1 ~ 28
5. Press  to select the Pre-Act 2 (subset) value of 1.5 lbs.
DISPLAY READS ► PA 2 ~ 1.5
6. Press **.5**  to select a new Pre-Act 2 value of .5 lbs.
DISPLAY READS ► PA 2 ~ .5
7. Press  to display the current Gross Weight.
DISPLAY READS ► 15.12

To change targets from the Weigh Mode (355 I.S.):

1. Press  to view the current fill target.
DISPLAY READS ► Targ1 ~ 250
2. Key in the new target value and press . Example  .
DISPLAY READS ► Targ1 ~ 100

Example (Percentage Check-Weighing)

With a system set up to check-weigh ice cream containers, the following settings might be used to guarantee container weights from 1.98 to 2.04 lbs.:

Parameter Setting	Acceptable Check-weigh Values	Comments
Target = 2.00		Desired container weight.
Percent Lo Value = 1	$2.00 * .01 = 0.02$	Low acceptable range = 1.98 to 2.00.
Percent Hi Value = 2	$2.00 * .02 = 0.04$	High acceptable range = 2.00 to 2.04.

Fill

The fill program is used for single-speed or dual-speed filling operations. The dual-speed fill operation allows for both a fast and a slow fill mode. During a fast-fill, setpoints 1 and 2 are activated. During a slow-fill or single-speed fill, only setpoint 1 is activated.

Table 7: Setpoint Setup (Fill)

Setpoint Selection	Function	Description
P5100.1	Fill	Select Fill Setpoint Operation
P5101.--	Targ1	Final Fill Target Value
P5104.0	Based	Select between Net or Quantity
P5105.--	PA 1	Pre-Act 1 Value (Fast-to-Slow Value; 0 for Single-Speed)
P5107.0	Start 1	Setpoint Activation Method
P5109.--	PA 2	Pre-Act 2 Value (Final Cutoff)
P5110.1	Learn 2	Learn Feature for Pre-Act 2
P5114.1	PrAc 1	Pre-Act 1 Available as Subset in Weigh Mode
P5115.1	PrAc 2	Pre-Act 2 Available as Subset in Weigh Mode
P5116.1	Pause	Keypad Press invokes Pause

See *Key-In Parameters* on page 35 for instructions on using front panel keys for entering data.

Activation Method (Fill)

The fill begins with the selected activation method. The deactivation of the setpoints is automatic. The desired target may be based on net or quantity (if counting is enabled). See *Activation Methods (General)* on page 56 for activation details.

Fill Status	Annunciator Status	Setpoint Status (Requires Setpoint Option Board)
Fast Fill	SP 1 & SP 2 Illuminated	Relay 1 and Relay 2 Contacts Closed
Dribble Fill (or Single-Speed Fill)	SP 1 Illuminated	Relay 1 Contacts Closed
Fill Done or Pause	SP 1 & SP 2 Off	Relay 1 and Relay 2 Contacts Open

Pre-Acts (Fill)

Pre-act 1 is used for dual-speed filling. Pre-act 1 specifies when the M350 should switch from fast-fill to slow-fill. When using a single-speed device, pre-act 1 should be set to 0 from the Setup Mode. Disabling P5114 and/or P5115 only removes them from the menu but still uses any value entered in the parameters as preact values.

Pre-act 2 specifies the target where the final cutoff should occur, regardless of a single-speed or dual-speed operation. See *Pre-acts (General)* on page 57 for details on the operational functions of pre-acts.



Pre-act 1 controls setpoint 2. Pre-act 2 controls setpoint 1.





Learn Feature (Fill)

Pre-act 2 has a learn feature available which allows the indicator to adjust the final cutoff based on changing environmental conditions. See *Learn Feature (General)* on page 57 for 'learn' feature details.

Pause Feature (Fill)

The standard pause feature (keypress, remote key closure or both) is available for the fill operation. See *Pause Feature (General)* on page 57 for ‘pause’ function details.

Changing Targets From The Weigh Mode (Fill)

When Fill is configured in the setpoint setup, Targ 1 automatically becomes an available mode for the  key. An entry followed by  or  changes targ 1. Pressing  or  alone allows access to the subsets. PA 1 and PA 2 are the Fill subsets. The pre-acts can be deleted as subsets by choosing Disabled at P5114 and P5115. See *Changing Targets from the Weigh Mode (General)* on page 58 for detailed instructions on changing target values from the Weigh Mode.

Example (Fill)

With a system set up to fill 55-gallon drums with motor oil, the following settings might be used to achieve an accurate final fill weight of 400 lbs.:

Parameter Setting	Actual Cutoff Value	Comments
Targ 1 = 400		Desired final weight.
Pre-act 1 = 28	$400 - 28 = 372.0$	Switch to dribble feed at 372.
Pre-act 2 = .5	$400 - 0.5 = 399.5$	Final fill valve closes at 399.5.

Batch

The standard batch program is used for batching up to three separate items. Ingredients 1 through 3 use setpoints and pre-acts 1 through 3 respectively. Ingredients are batched one at a time.

Table 8: Setpoint Setup (Batch)

Setpoint Selection	Function	Description
P5100.3	Batch	2 or 3 ingredient batching.
P5101.--	Targ1	Ingredient 1 target value.
P5104.0	Based	Select from <i>net</i> or <i>count (quantity)</i> .
P5105.--	PA 1	Pre-act 1 value (final cutoff for ingredient 1).
P5106.1	Learn 1	Learn feature for pre-act 1 enabled.
P5107.0	Start 1	Setpoint 1 activation method.
P5108.--	Targ 2	Ingredient 2 target value.
P5109.--	PA 2	Pre-act 2 value (final cutoff for ingredient 2).
P5110.1	Learn 2	Learn feature for pre-act 2 enabled.
P5111.0	Start 2	Setpoint 2 activation method.
P5116.1	Pause	Keypad press invokes pause mode.
P5117.--	Targ 3	Ingredient 3 target value.
P5118.--	PrAc 3	Pre-act 3 value (final cutoff for ingredient 3).
P5119.1	Learn 3	Learn feature for pre-act 3 enabled.
P5120.0	Start 3	Setpoint 3 activation method.

See *Key-In Parameters* on page 35 for instructions on using front panel keys for entering data.

Activation Method (Batch)

The filling of each ingredient begins when one of three selectable start functions occur. Each ingredient may have its own start function. The deactivation of the setpoint is automatic. The desired targets may be based on net weight or quantity (if counting is enabled). All ingredients must be based on the same parameter. See *Activation Methods (General)* on page 56 for details on activation methods.

Batch Status	Annunciator Status	Setpoint Status (Requires Setpoint Option Board)
Fill 1	SP 1 Illuminated	Relay 1 Contacts Closed, Relay 2 and 3 Contacts Open
Fill 2	SP 2 Illuminated	Relay 2 Contacts Closed, Relay 1 and 3 Contacts Open
Fill 3	SP 3 Illuminated	Relay 3 Contacts Closed, Relay 1 and 2 Contacts Open

Pre-Acts (Batch)

Pre-acts 1, 2 and 3 specify the final cutoff for each respective ingredient. See *Per-acts (General)* on page 57 for pre-act details.





Learn Feature (Batch)

Each batch pre-act has the learn feature available which allows the indicator to automatically adjust the final cutoff based on changing environmental conditions. See *Learn Feature (General)* on page 57 for 'learn' feature details.

Pause Feature (Batch)

The standard pause feature (keypress, remote key closure or both) is available for the batch operation. See *Pause Feature (General)* on page 57 for 'pause' details.

Changing Targets From The Weigh Mode (Batch)

When Batch is configured in the setpoint setup, Targ 1, 2 and 3 automatically become available modes for the  key. A keyed in entry followed by  or  changes the value of current target. Pressing  or  alone allows access to the subsets of the currently viewed target. PA 1, 2 and 3 are the respective subsets for Targ 1, 2 and 3. See *Changing Targets from the Weigh Mode (General)* on page 58 for detailed instructions on changing target values from the Weigh Mode.



Pre-acts 1 and 2 are *always* available as subsets of their respective targets from the Weigh Mode.

Example (Batch)

With a system set up a system to make a 50,000 lb batch with water (30,000 lbs.), corn syrup (15,000 lbs.) and caramel color (5,000 lbs.), ingredient 1 should start with  and subsequent ingredients should auto-start.

Parameter Setting	Actual Cutoff Value	Comments
Target 1 = 30,000		Desired water weight.
Based = Net		Targets are compared to net weight.
Pre-Act 1 = 100	$30,000 - 100 = 29,900$	Water valve closes at 29,900 lbs. Free-fall will bring weight to 30,000.
Learn 1 = Enabled		Analyze previous five fills and auto-adjust pre-act 1.
Start 1 = Tare		Start water with  .
Target 2 = 15,000		Desired corn syrup weight.
Pre-Act 2 = 236	$15,000 - 236 = 14,764$	Corn syrup valve closes at 14,764 lbs. Free-fall will bring weight to 15,000.
Learn 2 = Enabled		Analyze previous five fills and auto-adjust pre-act 2.
Start 2 = Auto	Calculated cutoff value for corn syrup is added to current displayed weight	Start corn syrup when water is done and motion has stopped.
Target 3 = 5,000		Desired caramel coloring weight.
Pre-Act 3 = 142	$5,000 - 142 = 4,858$	Carmel coloring valve closes at 4,858. Free-fall will bring weight to 5,000.
Learn 3 = Enabled		Analyze previous five fills and auto-adjust pre-act 3.
Start 3 = Auto	Calculated cutoff value for carmel coloring is added to current displayed weight	Start caramel coloring when corn syrup is done and motion has ceased.
Pause = Keypad		Keypress will pause batch operation.

Discharge

The discharge program is designed for single-speed or dual-speed dispensing of product from a larger weigh vessel. Discharge is a loss-in-weight application similar in operation to the fill program. When a discharge is initiated, the scale automatically tares and comes to a net zero weight. The appropriate setpoints are activated and material is discharged until the decreasing net weight reaches the desired target value.

Table 9: Setpoint Setup (Discharge)

Setpoint Selection	Function	Description
P5100.1	Discharge	Select discharge setpoint operation.
P5101.--	Targ1	Final dispensed target value.
P5104.0	Based	Select between net or count (quantity)
P5105.--	PA 1	Pre-act 1 value (fast-to-slow value; 0 for single-speed).

Setpoint Selection	Function	Description
P5107.0	Start 1	Setpoint activation method.
P5109.--	PA 2	Pre-act 2 value (final cutoff).
P5110.1	Learn 2	Learn feature for pre-act 2.
P5114.1	PrAc 1	Pre-act 1 available as subset in Weigh Mode.
P5115.1	PrAc 2	Pre-act 2 available as subset in Weigh Mode.
P5116.1	Pause	Keypress invokes pause.

See *Key-In Parameters* on page 35 for instructions on using front panel keys for entering data.

Activation Method (Discharge)

The dispensing activation is limited to  or a remote key input. The deactivation of the setpoints is automatic. The desired target may be based on net or quantity (if counting is enabled). See *Activation Methods (General)* on page 56 for activation details.

Discharge Status	Annunciator Status	Setpoint Status (Requires Setpoint Option Board)
Fast Discharge	SP 1 & SP 2 Illuminated	Relay 1 and 2 Contacts Closed
Slow (or Single-Speed) Discharge	SP 1 Illuminated	Relay 1 Contacts Closed
Fill Done or Pause	SP 1 & 2 Off	Relay 1 and 2 Contacts Open

Pre-Acts (Discharge)

Pre-act 1 is used for dual-speed dispensing. Pre-act 1 specifies when the system should switch from fast-discharge to slow-discharge. When using a single-speed device, pre-act 1 should be set to 0 from the Setup Mode. P5114 should also be disabled to prevent pre-act 1 from appearing as a subset of the target in the Weigh Mode. Pre-act 2 specifies the point where the final cutoff should occur, regardless of a single-speed or dual-speed operation. See *Pre-acts (General)* on page 57 for details on the operational functions of pre-acts.



Pre-act 1 controls setpoint 2. Pre-act 2 controls setpoint 1.





Learn Feature (Discharge)

Pre-act 2 has the learn feature available which allows the indicator to automatically adjust the final cutoff based on changing environmental conditions. See *Learn Feature (General)* on page 57 for learn feature details.

Pause Feature (Discharge)

The standard pause feature (keypress, remote key closure or both) is available for the discharge operation. See *Pause Feature (General)* on page 57 for pause function details.

Changing Targets From The Weigh Mode (Discharge)

When Discharge is configured in the setpoint setup, Targ 1 automatically becomes an available mode for the  key. An entry followed by  or  changes Targ 1. Pressing  or  alone allows access to the subsets. PA 1 and PA 2 are the subsets for Targ 1. The pre-acts can be deleted as subsets by choosing ‘disabled’ at P5114 and P5115. See *Changing Targets from the Weigh Mode (General)* on page 58 for instructions on changing target values from the Weigh Mode.





Target and pre-act values are entered as positive values.

If the total amount of product in the weigh vessel is less than the entered target, the indicator will prompt *Tare ~ =Cont*. Pressing  will dispense whatever is left in the vessel. Pressing any other key will abort the discharge cycle to allow for refilling the vessel.

Example (Discharge)

With a system set up to dispense ball bearings from a 50,000 lb weigh-bin and the fast-feed requiring an early cutoff to slow-feed, the following settings might be used to achieve accurate dispensing of 1000 bearings:

Parameter Setting	Actual Cutoff Value	Comments
Targ 1 = 1000	0 – 1000 = (-1000)	Desired quantity (decreasing value from a net zero: enter as a positive value).
Based = Qty		Targets are compared to quantity (P170 Enabled).
PA 1 = 200	1000 – 200 = 800 0 – 800 = (-800)	Switch to slow feed at –800 bearings (decreasing value from a net zero: enter as a positive value).
Start = 		Start discharge with  .
PA 2 = 15	1000 – 15 = 985 0 – 985 = (-985)	Final gate begins closing at 985 bearings. Delayed closure brings final quantity to 1000 (decreasing value from a net zero: enter as a positive value).
Learn 2 = Enabled		Analyze five previous operations and auto-adjust Pre-Act 2.
PrAc 1 = Enabled		Pre-act 1 available as subset of Targ 1 in Weigh Mode.
PrAc 2 = Disabled		Pre-act 2 NOT available as subset of Targ 1 in Weigh Mode (auto-adjust only).
Pause – Remote		Remote key closure invokes Pause.

Both

The ‘Both’ program combines a fill operation with a discharge operation. This automates a single-speed vessel filling operation with a single-speed multiple dispensing function. Setpoint 1 is used for filling the vessel and Setpoint 2 is used for product discharge. The ‘both’ program uses values for two targets and two pre-acts. Both targets must be based alike (net or quantity, quantity if count is selected).

Table 10: Setpoint Setup (Both)

Setpoint Selection	Function	Description
P5100.5	Both	Select both setpoint operation.
P5101.--	Targ1	Vessel fill target value.
P5104.0	Based	Select from <i>Net</i> or <i>Count (Quantity)</i> .
P5105.--	PA 1	Pre-act 1 value for vessel fill.
P5106.1	Learn 1	Learn feature for pre-act 1.
P5107.0	Start 1	Setpoint 1 activation method.
P5108.--	Targ 2	Vessel discharge target value.
P5109.--	PA 2	Pre-act 2 value for vessel discharge.
P5110.1	Learn 2	Learn feature for pre-act 2.
P5111.0	Start 2	Setpoint 2 activation method.
P5116.1	Pause	Keypad press invokes pause.

See *Key-In Parameters* on page 35 for instructions on using front panel keys for entering data.

Activation Method (Both)

The fill and discharge functions begin with their selected activation methods. The deactivation of the setpoints is automatic. The desired target may be based on net or quantity (if counting is enabled). See *Activation Methods (General)* on page 56 for activation details.

Both Status	Annunciator Status	Setpoint Status (Requires Setpoint Option Board)
Vessel Fill	SP 1 Illuminated	Relay 1 Contacts Closed
Vessel Discharge	SP 2 Illuminated	Relay 2 Contacts Closed
Fill Done or Pause	SP 1 & SP 2 Off	Relay 1 and Relay 2 Contacts Open

Pre-Acts (Both)

Pre-act 1 is used for vessel filling. Pre-act 1 specifies the point where the final cutoff for the fill should occur. Pre-act 2 specifies the point where the final cutoff for the material discharge should occur. See *Pre-acts (General)* on page 57 for details on the operational functions of pre-acts.



Pre-act 1 controls setpoint 1. Pre-act 2 controls setpoint 2.



Learn Feature (Both)



Both pre-act 1 and 2 have the learn feature available which allows the indicator to automatically adjust the final cutoff based on changing environmental conditions. See *Learn Feature (General)* on page 57 for 'learn' feature details.

Pause Feature (Both)

The standard pause feature (keypress, remote key closure or both) is available for the Both operation. See *Pause Feature (General)* on page 57 for 'pause' functions details.

Changing Targets From The Weigh Mode (Both)

When Both is configured in the setpoint setup, Targ 1 and Targ 2 automatically become available modes for the  key. An entry followed by  or  changes the currently viewed target.

Pressing  or  alone allows access to the subsets. PA 1 is the subset for Targ 1 and PA 2 is the subset for Targ 2.





Pre-acts 1 and 2 are always available as subsets of their respective targets from the Weigh Mode.

Since the discharge portion of the Both cycle is a loss-in-weight operation, target 2 and pre-act 2 entries are entered as positive values and interpreted by the indicator as negative. See *Changing Targets from the Weigh Mode (General)* on page 58 for detailed instructions on changing target values from the Weigh Mode.

Example (Both)

With a system set up to fill a weigh vessel with 2000 lbs. of paint and to meter out the paint in 45 lb buckets, the following settings might be used:

Parameter Setting	Actual Cutoff Value	Comments
Targ 1 = 2000		Desired vessel fill target.
Based = Net		Targets are compared to net weight.
PA 1 = 5	$2000 - 5 = 1995$	Fill valve closes at 1995 lbs.
Learn 1 = Enabled		Analyze five previous fills and auto-adjust pre-act 1.
Start 1 = R-but		Start fill with remote key closure.
Targ 2 = 45	$0 - 45 = (-45)$	Desired discharge target (decreasing weight from a net zero: enter as a positive value).
PA 2 = 5	$45 - 5 = 40$ $0 - 40 = (-40)$	Discharge valve closes at (-40) lbs. (decreasing weight from a net zero: enter as a positive value).
Learn 2 = Enabled		Analyze five previous discharges and auto-adjust pre-act 2.
Start 2 = 		Start discharge with 
Pause = None		Disable pause function.

Absolute Check-Weighing

This program is commonly used for check-weigh applications. After a target weight is entered, upper and lower tolerances are entered as absolute values. Over and Under tolerances are also entered as absolute values. The desired target may be based on gross weight, net weight, or quantity (if counting is enabled). Only the annunciators will light to indicator the setpoint status. Physical setpoints cannot be added at this time. The setpoint modules will be available in the near future and will be installed in a safe area hub.

Table 11: Setpoint Setup (Absolute Check-Weighing)

Setpoint Selection	Function	Description
P5100.6	ChecA	Check-weigh by absolute value.
P5101.--	Targ1	Absolute target value.

Setpoint Selection	Function	Description
P5102.--	Lo	Low acceptance value.
P5103.--	Hi	High acceptance value.
P5104.0	Based	Select from <i>Net, Gross</i> or <i>Count (Quantity)</i> .

See *Key-In Parameters* on page 35 for instructions on using front panel keys for entering data.

Setpoint Activation (Absolute Check-Weighing)

In order for the annunciators or setpoints to activate, the displayed value must be at least five graduations above zero. A setpoint option board may be installed to allow the M350 to directly control lights, buzzers, drop-gates, or reject devices.

Check-Weigh Status	Annunciator Status	Annunciator Color (LED)
OVER	SP 1 Illuminated	Red
GOOD	SP 2 Illuminated	Green
UNDER	SP 3 Illuminated	Yellow



The Pre-Acts, Learn Mode, and Pause Feature options are not applicable to check-weigh operation.

Changing Targets From The Weigh Mode (Absolute Check-Weighing)

When Check-Weigh by Absolute is configured in the setpoint setup, the Targ 1 value automatically becomes an available mode for the key. It is possible to accept the applied weight as the target. Instead of keying in the target value from Targ 1, press (350 I.S.) or (355 I.S.). Press (350 I.S.) or (355 I.S.) again to accept the target.

To change targets from the Weigh Mode (350 I.S.):

1. Press .
DISPLAY READS ► 0.00
2. Press to view the current fill target.
DISPLAY READS ► Targ1 ~ 250
3. Press **400** to set a new fill target of 400 lbs.
DISPLAY READS ► Targ1 ~ 400
4. Press to select the Pre-Act 1 (subset) value of 28 lbs.
DISPLAY READS ► PA 1 ~ 28
5. Press to select the Pre-Act 2 (subset) value of 1.5 lbs.
DISPLAY READS ► PA 2 ~ 1.5
6. Press **.5** to select a new Pre-Act 2 value of .5 lbs.

DISPLAY READS ► PA 2 ~ .5

- Press to display the current Gross Weight.

DISPLAY READS ► 15.12

To change targets from the Weigh Mode (355 I.S.):

- Press to view the current fill target.

DISPLAY READS ► Targ1 ~ 250

- Key in the new target value and press . Example

DISPLAY READS ► Targ1 ~ 100

Example (Absolute Check-Weighing)

With a system set up to check-weigh 50 lb. cement bags, the following settings might be used check-weigh bag from 49.5 to 51.5 lbs.:

Parameter Setting	Acceptable Check-Weigh Values	Comments
Target = 50.00		Desired bag weight.
Low Value = 49.50	49.50 – 50.00 lbs.	Low acceptable range = 49.50 to 50.00 lbs.
High Value = 51.50	50.00 – 51.50 lbs.	High acceptable range = 50.00 to 51.50 lbs.

Independent Setpoint Operation

Independent Setpoints allow controlling setpoints when the gross, net or quantity (if counting is enabled) is above or below a target value. The reset (deactivation) choice of each setpoint is selectable from *Tare*, *Remote Key*, *Auto*, *Non-latching* or *Absolute*. See *Key-In Parameters* on page 35 for instructions on using front panel keys for data entry.

Table 12: Setpoint Setup (Independent)

Setpoint Selection	Function	Description
P5100.7	Indep	Independent Setpoints.
P5121.1	Base 1	Select from <i>Net</i> , <i>Gross</i> or <i>Count (Quantity)</i> for setpoint 1.
P5122.0	Act 1	Activate setpoint 1 when weight is above or below.
P5123.--	Targ 1	Setpoint 1 target for weight to either rise above or fall below.
P5124.0	Stbl 1	Setpoint 1 activation stability setting.
P5125.0	Rset 1	Reset selection for setpoint 1.
P5126.--	Rtrg 1	Value for reset. *Only available if “Value” is selected for Reset 1.
P5127.1	Rstb 1	Reset 1 stability setting.
P5131.1	Base 2	Select from <i>Net</i> , <i>Gross</i> or <i>Count (Quantity)</i> for Setpoint 2.
P5132.0	Act 2	Activate setpoint 2 when weight is above or below.
P5133.--	Targ 2	Setpoint 2 target for weight to either rise above or fall below.
P5134.0	Stbl 2	Setpoint 2 stability setting.
P5135.0	Rset 2	Reset selection for setpoint 2.
P5136.--	Rtrg 2	Value for reset. *Only available if “Value” is selected for Reset 2.
P5137.1	Rstb 2	Reset 2 stability setting.
P5141.1	Base 3	Select from <i>Net</i> , <i>Gross</i> or <i>Count (Quantity)</i> for Setpoint 3.

Setpoint Selection	Function	Description
P5142.0	Act 3	Activate setpoint 3 when weight is above or below.
P5143.--	Targ 3	Setpoint 3 target for weight to either rise above or fall below.
P5144.0	Stbl 3	Setpoint 3 stability setting.
P5145.0	Rset 3	Reset selection for setpoint 3.
P5146.--	Rtrg 3	Value for reset. *Only available if "Value" is selected for Reset 3.
P5147.1	Rstb 3	Reset 3 stability setting.

Setpoint Activation (Independent)

Independent Setpoints can be activated when either the gross weight, net weight or quantity (if counting is enabled) is above or below a target value. When an independent setpoint is set to Activate Above, the setpoint will activate when the selected mode (gross, net or quantity) is equal to or above the target. When set to Activate Below, the selected mode must actually be below the target.



A setpoint option board may be installed to allow the M350 to directly control lights, buzzers, valves or relays. Also, the setpoints can be configured to ignore or heed the stability setting (P114).

Independent Status	Annunciator Status	Setpoint Status (Requires Setpoint Option Board)
Setpoint 1 Active	SP 1 Illuminated	Relay 1 Closed
Setpoint 2 Active	SP 2 Illuminated	Relay 2 Closed
Setpoint 3 Active	SP 3 Illuminated	Relay 3 Closed

Independent Setpoint Reset (deactivation) choices:

Parameter Setting	Reset Choice	Description
P51x5.0	Tare	Setpoint deactivates with .
P51x5.1	Remote Key	Setpoint deactivates with Remote Key closure.
P51x5.2	Auto	Setpoint deactivates when weight returns to +/- 5 graduations of zero and stabilizes.
P51x5.3	Non-Latched	Setpoint deactivates when weight value is in a range opposite of the activation setting.
P51x5.4	Reset Value	Setpoint deactivates when weigh reaches a second value and stabilizes.



The Pre-Acts, Learn Mode, and Pause Feature options are not applicable to Independent Setpoint operation.

Changing Targets From The Weigh Mode (Independent)

When Independent Setpoints are configured in the setpoint setup, Targ 1, 2 and 3 automatically become available modes for the key. An entry followed by or changes the currently viewed target. If the reset for a setpoint is set to 'value', then pressing or alone will allow access to the subset of the target. Rtrg 1, 2 and 3 are the respective subsets for Targ 1, 2 and 3. See *Changing Targets from the Weigh Mode (General)* on page 58 for detailed instructions on changing target values from the Weigh Mode.

Example (Independent)

Setup a continuous-cycle static weighing system that fills a weigh hopper from a storage bin. The weigh hopper should stop the fill at a predetermined target, dump the product into a bag, and then restart the fill. A warning light should come on to give an operator advance notice to change the bag. The following setup might be used to achieve 1000 lb dumps:

Parameter Setting	Description
<i>P5121.1 ~ Base 1 ~ Net</i>	Weigh hopper dump valve based on net weight.
<i>P5122.0 ~ Act 1 ~ HI</i>	Hopper dump valve opens when net weight rises above target 1.
<i>P5123.-- ~ Targ 1 ~ 1000</i>	Target 1 value = 1000 kg.
<i>P5124.1 ~ Stbl 1 ~ Inhib</i>	Hopper dump valve delayed until scale is stable.
<i>P5125.2 ~ Rset 1 ~ Auto</i>	Dump valve auto-closes when net is within +/- 5 grads of zero and stable.
<i>P5127.1 ~ Rstb1 ~ Inhib</i>	Dump valve closure delayed until scale is stable.
<i>P5131.1 ~ Base2 ~ Net</i>	Weigh hopper fill valve based on net weight.
<i>P5132.1 ~ Act 2 ~ Under</i>	Fill valve opens when net weight falls below target 2.
<i>P5133.-- ~ Targ 2 ~ =100</i>	Target 2 value = 100 kg.
<i>P5134.1 ~ Stbl2 ~ =Inhib</i>	Fill valve opening delayed until scale is stable.
<i>P5135.4 ~ Rset 2 ~ =Targ</i>	Fill valve closes when net weight reaches reset target 2.
<i>P5136.-- ~ Rtrg2 ~ 1000</i>	Reset target 2 = 1000 kg.
<i>P5137.0 ~ Rstb2 ~ Ignore</i>	Fill valve closes regardless of stability.
<i>P5141.1 ~ Base 3 ~ Net</i>	Alarm light relay based on net weight.
<i>P5142.0 ~ Act 3 ~ Above</i>	Alarm relay activates when net weight rises above target 3.
<i>P5143.-- ~ Targ 3 ~ =900</i>	Target 3 = 900 kg.
<i>P5144.0 ~ Stbl3 ~ Ignore</i>	Alarm relay activates regardless of scale stability.
<i>P5145.3 ~ Rset 3 ~ Non-L</i>	Alarm relay closes when net weight falls below target 3.
<i>P5147.0 ~ Rset3 ~ Ignore</i>	Alarm relay closes regardless of scale stability.

Target Deviation Check-Weighing

The target deviation method uses a target value in which the upper and lower tolerances are deviated from the target. The upper and lower tolerances are fixed values. The accept window is varied by adding the high tolerance to the target and subtracting the low tolerance from the target. This feature is commonly used in check-weigh applications. The desired target may be based on gross weight, net weight or quantity (if counting is enabled). The annunciators will light on the indicator display or physical setpoints can be added to the safe area hub.

Table 13: Setpoint Setup (Target Deviation Check-Weighing)

Setpoint Selection	Function	Description
P5100.8	Checb	Target Deviation Mode.
P5101.--	Targ1	Target value.
P5102.--	Lo	Low acceptance deviation.
P5103.--	Hi	High acceptance deviation.
P5104.0	Based	Select from <i>Net</i> , <i>Gross</i> or <i>Quantity</i> .

See *Key-In Parameters* on page 35 for instructions on using the front panel keys for entering data.

Setpoint Activation (Target Deviation Check-Weighing)





In order for the annunciators to activate, the displayed value must be at least five graduations above zero.

Check-Weigh Status	Annunciator Status	Annunciator Color (LED)
OVER	SP 1 Illuminated	Red
GOOD	SP 2 Illuminated	Green
UNDER	SP 3 Illuminated	Yellow













The Pre-Acts, Learn Mode, and Pause Feature options are not applicable to check-weigh operation.















Changing Targets From The Weigh Mode (Target Deviation Check-Weighing)

When Check-Weigh by Deviation is configured in the setpoint setup, the Targ 1 value automatically becomes an available mode for the  key. It is possible to accept the applied weight as the target. Instead of keying in the target value from Targ 1, press  (350 I.S.) or  (355 I.S.). Press  (350 I.S.) or  (355 I.S.) again to accept the target. Lo and Hi are the subsets for Targ 1. Lo and Hi are entered as actual values.

To change target to 10 from the Weigh Mode (350 I.S.):

- From the weigh mode press  until *targ1* is shown on the display.
DISPLAY READS ► Targ1 ~15.00
- Press **10**  to set a new target. Either press  to go to the weigh mode or go to step 3 to access the low tolerance parameter.
DISPLAY READS ► Targ1 ~ 10.00
- Press  to access the low tolerance parameter. This parameter does not have to be changed. Go to step 4 to change the low tolerance or press  to go to the weigh mode or press  to view the high tolerance, go to step 6.
DISPLAY READS ► Lo ~ 2
- Set the low tolerance to a specific value. For example press **1**  to set a new low tolerance.
DISPLAY READS ► Lo ~ 1
- Press  to access the high tolerance setting.
DISPLAY READS ► Hi ~ 3
- Set the high tolerance to a specific value. Press **2**  to set a new high tolerance.
DISPLAY READS ► Hi ~ 2
- Press  to display the current Gross Weight.
DISPLAY READS ► 15.12

To change target to 10 from the Weigh Mode (355 I.S.):

1. Press  to view the current target.
DISPLAY READS ► Targ1 ~ 15.00
2. Key in the new target value and press . Example   .
DISPLAY READS ► Targ1 ~ 10.00
3. Press  to access the low tolerance parameter. This parameter does not have to be changed. Go to step 4 to change the low tolerance or press  to go to the weigh mode or press  to view the high tolerance, go to step 6.
DISPLAY READS ► Lo ~ 2
4. Set the low tolerance to a specific value. For example press   to set a new low tolerance.
DISPLAY READS ► Lo ~ 1
5. Press  to access the high tolerance setting.
DISPLAY READS ► Hi ~ 3
6. Set the high tolerance to a specific value. Press   to set a new high tolerance.
DISPLAY READS ► Hi ~ 2
7. Press  to display the current Gross Weight.
DISPLAY READS ► 15.12

Example (Target Deviation Check-Weighing)

With a system set up to check-weigh ice cream containers, the following settings might be used to guarantee container weights from 1.98 to 2.04 lbs.:

Parameter Setting	Acceptable Check-weigh Values	Comments
Target = 10.00		Desired container weight.
Lo Value = 0.5	$10.00 - 0.5 = 9.50$	Low acceptable range = 9.50 to 10.00
Hi Value = 0.25	$10.00 + 0.25 = 10.25$	High acceptable range = 10.00 to 10.25

Time and Date Setup (Model 350 I.S.)















The time and date feature is stored as non-volatile (time/date setting will not be lost when the unit power is reset). The time/date parameter is available in the first two fixed transmits (See *Transmit Selection on page 44*) and can be included in a custom transmit (See *Custom Transmit Setup on page 50*).

The time and date can be accessed from the weigh mode with the  key if P502 is enabled. Also 11%*s* can be sent into the comm port to access the time/date entry regardless of P502.

The time and date can be entered in the setup mode at P500 and P501. Access P500 to change the time or P501 to change the date. To access the setup mode see page 32. Use the instructions below to enter the time and/or date. Refer to page to save the time and date and exit to the weigh mode.

To enter the time from the *Enter~time~00.00.00 prompt*















EXAMPLE: 16.32.41 (4:32:41 P.M.)

1. Press  to toggle through the numbers to enter the hour. Hours must be entered as military time.
DISPLAY READS ► 1
2. Press  once to move the cursor. Press  to select the next digit.
DISPLAY READS ► 16
3. Press  twice to move the decimal point over to separate the hour from the minutes. It is not necessary to enter a 0 before a single digit hour.
DISPLAY READS ► 16.
4. Press  to toggle through the numbers to enter the minutes.
DISPLAY READS ► 16.3
5. Press  once to move the cursor. Press  to select the next digit.
DISPLAY READS ► 16.32
6. Press  twice to move the decimal point over to separate the minutes from the seconds.
DISPLAY READS ► 16.32.
7. Press  to toggle through the numbers to enter the seconds. The seconds do not have to be entered. Press  to bypass entering the seconds.
DISPLAY READS ► 16.32.4
8. Press  once to move the cursor. Press  to select the next digit.
DISPLAY READS ► 16.32.41
9. Press  to accept the time entry.
DISPLAY READS ► 16.32.41
10. Press  once to move to the date.

To enter the date from the *Enter~date~01.01.70 prompt*





EXAMPLE: 08.17.04 (August 17, 2004)

1. Press  to toggle through the numbers to enter the month.
DISPLAY READS ► 8

2. Press  twice to move the decimal point over to separate the month from the day. It is not necessary to enter a 0 before a single digit month. If it is a double-digit entry, press  once to move the cursor and then  to scroll through the digits.
DISPLAY READS ► 8.
3. Press  to toggle through the numbers to enter the day.
DISPLAY READS ► 8.1
4. Press  to move to the next digit. Press  to toggle through the numbers to enter the second digit.
DISPLAY READS ► 8.17
5. Press  twice to move the decimal point over to separate the day from the year. It is not necessary to enter a 0 before a single digit month. If it is a double-digit entry, press  once to move the cursor and then  to scroll through the digits.
DISPLAY READS ► 8.17.
6. Press  to toggle through the numbers to enter the year.
DISPLAY READS ► 8.17.0
7. Press  once to move the cursor and then press  to select the next digit.
DISPLAY READS ► 8.17.04
8. Press  to accept the entry.
DISPLAY READS ► 01.09.04
9. Press  to return to the weigh mode.

Time and Date Setup (Model 355 I.S.)

The time and date feature is stored as non-volatile (time/date setting will not be lost when the unit power is reset). The time/date parameter is available in the first two fixed transmits (See *Transmit Selection on page 44*) and can be included in a custom transmit (See *Custom Transmit Setup on page 50*).

The time and date can be accessed from the weigh mode with the  key if P502 is enabled. Also 11%_s can be sent into the comm port to access the time/date entry or 
 from the weigh mode regardless of P502.

The time and date can be entered in the same fashion as described below. Access P500 to change the time or P501 to change the date. To access the setup mode see page 32.

To enter the time from the *Enter~time~00.00.00* prompt
EXAMPLE: 16.32.41 (4:32:41 P.M.)

1. Key in the date in the following format:
DISPLAY READS ► 16.32.41
2. Press to except the time
3. Press to move to the date.

To enter the date from the *Enter~date~01.01.70 prompt*

EXAMPLE: 08.170.04 (August 17, 2004)

1. Key in the date in the following format:
DISPLAY READS ► 08.17.04
2. Press to except the date.
3. Press to return to the weigh mode.

Remote Key Configuration

The Model 350 and Model 355 I.S. has four selectable remote key operations to choose from: *Print, Tare, Zero* and *Print/Tare*. Only one of these operations may be assigned to the remote key input. Table 14 describes the available remote key operations. See *Remote Key Connection* on page 18 for information on connecting a remote key input device.

Table 14: Remote Key Operations

Remote Key 1 and 2 Selections	Function	Description
P800.00 or P801.00	None	Remote key disabled.
P800.01 or P801.01	Print	Initiates print function. Print restrictions (P200 – P212) will be adhered to.
P800.02 or P801.02	Tare	Initiates tare function. Tare restrictions (P161 - P169) will be adhered to.
P800.03 or P801.03	Zero	Initiates zero function. Zero restrictions (P118) will be adhered to.
P800.04 or P801.04	Print and Tare	Initiates print function and then tare function. (P200 – P212) will be adhered to. Also (P161 - P169) will be adhered to.



Tare, Zero and Print functions will be delayed according to the stability setting (P114). If a setpoint operation is configured to use the remote key as an activation method, the P800 setting is over-ridden.

Upgrade Indicator Firmware







The Model 350 I.S. and Model 355 I.S. have flash memory on the main board where the parameters are stored. It is possible to update the firmware simply by using a computer. The firmware is loaded into a flash memory IC. This allows for ease in loading firmware updates.



The flash memory on the main processor is only rated to be reflashed up to 10 times under extreme industrial and temperature conditions.

Prepare For Upgrade

Before the indicator firmware can be updated, the procedure below must be followed. A computer with a serial port or USB port is required for loading a flash file. If you are using a USB port, a USB to serial converter is necessary.

1. Connect the communication cable from the computer to comm. 1 of the Model 350 I.S. or Model 355 I.S.
2. Open a communications program or terminal window program (such as Communication Plus) on the computer.
3. Set the protocol of the indicator to be 9600 baud, 1 stop bit, no parity.
4. Go to parameter 65020 (re-flash) and press  (350 I.S.) or  (355 I.S.). Press  (350 I.S.) or  (355 I.S.) at the "ARE YOU SURE ? prompt. Press  (350 I.S.) or  (355 I.S.) at the Enter = Flash prompt.

~ Or ~

Unplug the indicator and move Reflash jumper (E2) from NORMAL to RFLASH.

5. The terminal program should show:
GSE Scale Systems
Division of SPX
300 Series Bootloader Version *XX* (*where XX should be at least 03*)
Date (*where Date should be at least Feb 2004*)
 - a. Erase Flash
 - b. Program Flash
 - c. Set Baud Rate
 - d. Quit
6. Typically the default baud rate on the computer will be 9600. The programming time at 9600 baud is about 6 minutes. At 38400 baud the programming time is about one minute and a half. At 57600 baud the programming time is about one minute. Set the indicator baud rate in the terminal software to the desired baud rate by entering **c** from the computer keyboard. Set the baud rate of the terminal program to match the baud rate chosen for the indicator.

Load Flash File

1. The current flash file must be erased. Enter an **a** from the computer keyboard. When finished the menu choices will be replicated.
2. To program flash, enter a **b** from the computer keyboard. Open the flash file from your terminal window and send it to the indicator. After the file loads the menu choices will be replicated.
3. To end the flash process, enter a **d** from the computer keyboard to quit. The indicator will restart.
4. If the Reflash jumper (E2) was set to REFLASH, unplug the indicator and return the jumper to the NORMAL position.
5. In order to enable the Model 355 I.S. keypad you must cycle power and hold the  key on power up.

Analog Output Setup

Table 15: Analog Output Parameters

Parameter Setting	Displayed Name	Description	Type/choices (*=Default)
P171.00	<i>AnAlg</i>	Enable analog option.	Disbl*, Enabl
P172.00	<i>AnPar</i>	Parameter that analog signal corresponds to. <i>Displayed</i> corresponds to gross while viewing the gross weight and net otherwise.	Gross*, Net, Displayed
P173.--	<i>AnIFS</i>	Full scale value at which P172 selection yields an output of 10 volts. If set to 0, uses P110 setting.	Numeric Entry: 0* to ±1,000,000
P174.--	<i>AnOff</i>	Offset value which yields a 0 volt output.	Numeric Entry: 0* to ±1,000,000
P175.10	<i>AnRng</i>	Range Value (1-10) which specifies the max value of analog output – entered in terms of voltage. NOTE: This does not change the analog span. A 0-10,000 lb. output set to 8 will stop increasing its analog signal at 8,000 lbs.	Numeric entry: 0 to 10*
P176.01	<i>AnRst</i>	Reset state – Specifies analog signal level when Model 350 and Model 355 enters Setup Mode.	10 V (Max Output) 0 V (Min Output) No Change*
P177.00	<i>AType</i>	Specifies output type: voltage or current.	0 –10 volts*, 0 –20mA, 4 –20mA

The actual output signal is calculated as follows:

$$V_{out} = \left(\frac{(P172: \text{Parm Value}) - (P174: \text{Zero Offset})}{(P173: \text{Full Scale Value}) - (P174: \text{Zero Offset})} \right) * 10$$

If the result is greater than the Max Range Value (P175), then the analog signal is limited to the Max Range Value.

Analog Output Calibration

Table 16: Analog Output Calibration Parameters

PARAMETER SETTING	DISPLAYED NAME	DESCRIPTION	TYPE/CHOICES (*=DEFAULT)
P61200	<i>10oFF</i>	Value required to precisely output 0V in 0 – 10V output mode (i.e. offset).	Numeric Entry: 0 to 15,000 (2,923*)
P61201	<i>10Gn</i>	Value required to precisely output 10V in 0 – 10V output mode (i.e. gain).	Numeric Entry: 50,000 to 65,535 (61,027*)
P61202	<i>0oFF</i>	Value required to precisely output 0 mA in 0 – 20 mA output mode (i.e. offset).	Not adjustable: (0*)
P61203	<i>0Gn</i>	Value required to precisely output 20 mA in 0 – 20mA output mode (i.e. gain).	Numeric Entry: 50,000 to 65,535 (54,555*)
P61204	<i>4oFF</i>	Value required to precisely output 0 mA in 4 – 20 mA output mode (i.e. offset).	Numeric Entry: 0 to 15,000 (10,910*)
P61205	<i>4Gn</i>	Value required to precisely output 20 mA in 4 – 20mA output mode (i.e. gain).	Numeric Entry: 50,000 to 65,535 (54,555*)
P61206	<i>Srln</i>	Analog option board serial number.	Numeric Entry: (0*) - 4,294,967,295

The analog output calibration procedure establishes explicit zero and full scale values for each of the three analog output modes: 0 – 10V, 0 – 20 mA and 4– 20 mA. There are five adjustment values for the analog option, located at the information parameters P61200 through P61205, that allow the zero and full scale output of each mode to be adjusted to exact values. This allows the analog option to be configured to match the needs of the system being connected to its outputs.

The calibration values for each of these modes has been determined at the factory. These values are provided on paper with each board to make calibrating the analog option a simple process. Each analog option board can be identified by its serial number, which is entered in the unit during the calibration process.

Entering Analog Calibration Values



An example of the printout included with each analog option kit follows below:

```



100%s23640%e           Access Setup Modes, Allowing Changes
60100%s%e              P60100.  c1998-GSE-
60101%s%e              P60101.  0Model 350  350p01009
60102%s%e              P60102.  06-30-2000
60200%s%e              P60200.  BrdSn573192
60201%s%e              P60201.  AuditTrail Euro  00001
60202%s%e              P60202.  InsSn329074
60203%s%e              P60203.  AuditTrail Cal.  00025
60204%s%e              P60204.  AuditTrail Setup 00050
61200%s2923%e          P61200.  10off  2923
61201%s61027%e         P61201.  10 Gn  61027
61202%s0%c             P61202.  0 off  0
61203%s54555%e         P61203.  0 Gn  54555
61204%s10910%e         P61204.  4 off  10910
61205%s54555%e         P61205.  4 Gn  54555
61206%s123456%e       P61206.  Srl n 123456
%z                      Exit Setup Mode



```

Analog calibration values can be entered into the Model 350 and Model 355 by keying in the data in the left-hand column, beginning at the line starting with “61200...”, replacing the “%s”

character pairs with the  key and “%e” with the  (350) or  (355) key. The line with the “%c” is not adjustable and cannot be entered.

You can adjust the included factory recommended offset and gain values to precisely configure the system being connected to these outputs. Once the initial factory values have been entered,

pressing the  (350) or  (355) key will cause the count value to increase one count, and

pressing the  +  keys will decrement the count value by one count. All changes made are updated “live” to aid in calibrating a specific device to the analog option board output. Holding down the key(s) will repeat the increment/decrement action.

Analog Output Example

Analog Parameter Setting	Parameter Description	Example Value	Comments
P172.01	Net Weight	3.00 lb	Current net weight.
P173.--	Analog Full Scale	20	Net weight value that would give maximum analog output.
P174.--	Zero Offset	-40	Net weight value that would give minimum analog output.
P175.--	Max Range Value	8	Maximum analog output allowed (entered in terms of voltage).

$$V_{\text{out}} = \left(\frac{3 - (-40)}{20 - (-40)} \right) * 10 = \left(\frac{43}{60} \right) * 10 = 7.166$$

Since 7.166 v is less than 8 v (per P175), the output signal is not restricted and would be 7.166 v.

If a current output is selected, the output is a milli-amp current where 0 volts corresponds to either 0 mA or mA (as per P177) and 10 volts would translate to 20 mA. Values in between would be scaled proportionately:

$$I_{\text{out}} = \left(\frac{(20 \text{ mA} - 4 \text{ mA}) * 7.166 \text{ v}}{10 \text{ v}} \right) + 4 \text{ mA} = \left(\frac{16 * 7.166}{10} \right) + 4 = 15.465 \text{ mA}$$

Analog signal resolution: the output is the result of a 16 bit conversion resulting in a resolution of 1 part in 65535 or $10 / 65535 = 0.00015 \text{ v}$.

Remote Display Configuration

The remote display function allows a master indicator (350 I.S. or 355 I.S.) to be echoed to another indicator (350 I.S., 355 I.S., 355) and be used in a remote location. There are certain parameters that must be set in order to have the master and slave indicators communicate together. Refer to the section below to configure the master and remote (slave) indicators.

Master To Remote (Slave) Configuration

The remote indicator will receive continuous transmission from the master indicator. It is necessary to setup the protocol parameters in both indicators so they match in order to coordinate the transmission. See Table 17 for the common protocol parameters. A remote indicator will not show the bargraph even if it is a LCD display.

Table 17: Common Settings for the Master and Remote indicators

Master	Remote	Parameter Description
P200 or P220	P200 or P220	Baud rate
P201 or P221	P201 or P221	Data bits
P202 or P222	P202 or P222	Parity
P203 or P223	P203 or P223	Stop bits
P204 or P224	P204 or P224	Handshaking
P291	P274	Start Character
P292	P275	End Character

To enter the master or remote setup (local setup)

It is possible to make changes to the master indicator setup mode from either the remote indicator or the master indicator itself. The master indicator setup mode can be entered from either the master or the remote indicators. However, the remote indicator (slave) setup mode can ONLY be entered from the remote indicator. After in the setup mode, you can make changes from the remote indicator or the master indicator.

To enter the master indicator or remote indicator (local indicator) setup mode (350 I.S. or 355 I.S.):

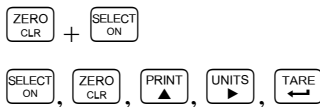

or



After the setup mode is entered, the numeric portion on the 355 I.S. keypad is restored. When in the remote (slave) setup, all annunciators are illuminated on the remote to distinguish between the master and remote (slave) indicators.

Setup Master Indicator

Set the following parameters on the master indicator:











- **P290** - Choose the communication port of the master indicator the remote indicator is connected to.
- **P291** - Transmit any ASCII character or control code to the remote indicator as a start character before echoing unit's display. Make sure this parameter matches P274 on the remote indicator.
- **P292** - Transmit any ASCII character or control code to the remote indicator as an ending character after echoing unit's display. Make sure this parameter matches P275 on the remote indicator.
- **P296** – Choose the remote indicator type, a 300 series or 60 series.













Setup Remote Indicator

For an indicator to become a remote display P260 must be set for *r-dsp*. There are two styles in which the remote indicator will display data received from the master indicator. These styles are *display* and *custom*. Choose one of the display styles at P271. Refer to page 87 for details on *display* and *custom* styles.

The parameters in Table 18 are available only when P260 is set for *r-dsp* or *Hub*. Refer to Table 18: Remote Display Setup Parameters for the available parameters and their descriptions.

Table 18: Remote Display Setup Parameters

Parameter Setting	Displayed Name	Description	Type/choices (*=Default)
P261.01	<i>R-port</i>	Choose the port in which the remote display (slave) will communicate with the master device.	1*, 2, None
P270.00	<i>T-out</i>	Determines whether the remote display (slave) will show a message when connection is lost.	Enable / Disable*
P271.00	<i>Style</i>	Set to display or custom. When set to <i>display</i> the remote will echo the display of the master indicator. When set to <i>custom</i> the remote receives a custom format from the master indicator. In <i>custom</i> mode the transmit may be send continuous or on demand.	Display* / Custom
P272.00	<i>Addr</i>	Set address for remote display. Only present if P271 is set for <i>custom</i> .	None*, 1-255
P273.01	<i>T-use</i>	Determines where transmits sent out the comm. port from the <i>master</i> or <i>control</i> indicator that is connected to the <i>remote</i> or <i>hub</i> are redirected to. Should not be set to the same port as P261 unless transmit wire is being used to connect to a printer connected to the remote indicator (In this case the keypad cannot be used to talk to the <i>master</i> or <i>control</i> indicator).	None*, Port 1, Port 2
P274.02	<i>Start</i>	Set the start character for the remote display. Choices are 0 – 255. Default value is 2 (STX). The choice must match the start character in P291 on the master display. Avoid using values of 17 or 19 when using software flow control. The values of 17 and 19 are Xon and Xoff codes and could cause conflict.	Numeric Entry: 0 to 255 2*
P275.03	<i>End</i>	Set the end character for the remote display. Choices are 0 – 255. Default value is 3 (ETX). The choice must match the end character in P292 on the master display. Avoid using values of 17 or 19 when using software flow control. The values of 17 and 19 are Xon and Xoff codes and could cause conflict.	Numeric Entry: 0 to 255 3*
P276.01	<i>Rptin</i>	Allow or disallow data received from the remote display's (slave) communication port to be sent to the master.	Enable* / Disable
P277.01	<i>R-start</i>	Enables or disables the use of the  key on the master indicator. When this parameter is enabled and the key is pressed, a start key command will be recognized by the master indicator. The Tx, Rx and GND line must be connected between the COMM Ports of the master and remote unit. If this parameter is disabled the  key will have no effect on the master indicator.	Enable* / Disable
P278.01	<i>R-stop</i>	Enables or disables the use of the  key on the master indicator. When this parameter is enabled and the key is pressed, a stop key command will be recognized by the master indicator. The Tx, Rx and GND line must be connected between the COMM Ports of the master and remote unit. If this parameter is disabled the  key will have no effect on the master indicator.	Enable* / Disable
P280.01	<i>Zero</i>	Enables or disables the use of the  key on the master indicator. When this parameter is enabled and the key is pressed, a Zero key command will be recognized by the master indicator. The Tx, Rx and GND line must be connected between the COMM Ports of the master and remote unit. If this parameter is disabled the  key will have no effect on the master indicator.	Enable* / Disable
P281.01	<i>Units</i>	Enables or disables the use of the  key on the master indicator. When this parameter is enabled and the key is pressed, a Units key command will be recognized by the master indicator. The Tx, Rx and GND line must be connected between the COMM Ports of the master and remote unit. If this parameter is disabled the  key will have no effect on the master indicator.	Enable* / Disable
P282.01	<i>Select</i>	Enables or disables the use of the  key on the master indicator. When this parameter is enabled and the key is pressed, a Select key command will be recognized by the master indicator. The Tx, Rx and GND line must be connected between the COMM Ports of the master and remote unit. If this parameter is disabled the  key will have no effect on the master indicator.	Enable* / Disable

Parameter Setting	Displayed Name	Description	Type/choices (*=Default)
P283.01	<i>Prtut</i>	Enables or disables the use of the  and  keys on the master indicator (350 I.S.). When this parameter is enabled and the keys are pressed, the Print and Units keys will be simulated. The Tx, Rx and GND line must be connected between the COMM Ports of the master and remote unit. If this parameter is disabled the keys will have no effect on the master indicator.	Enable* / Disable
P284.01	<i>Print</i>	Enables or disables the use of the  key on the master indicator. When this parameter is enabled and the key is pressed, a Print key command will be recognized by the master indicator. The Tx, Rx and GND line must be connected between the COMM Ports of the master and remote unit. If this parameter is disabled the  key will have no effect on the master indicator.	Enable* / Disable
P285.01	<i>Tare</i>	Enables or disables the use of the  key on the master indicator. When this parameter is enabled and the key is pressed, a Tare key command will be recognized by the master indicator. The Tx, Rx and GND line must be connected between the COMM Ports of the master and remote unit. If this parameter is disabled the  key will have no effect on the master indicator.	Enable* / Disable
P286.01	<i>Enter</i>	Enables or disables the use of the  key on the master indicator. When this parameter is enabled and the key is pressed, an Enter/Sample key command will be recognized by the master indicator. The Tx, Rx and GND line must be connected between the COMM Ports of the master and remote unit. If this parameter is disabled the  key will have no effect on the master indicator.	Enable* / Disable
P287.01	<i>Clear</i>	Enables or disables the use of the  key on the master indicator. When this parameter is enabled and the key is pressed, a clear key command will be recognized by the master indicator. The Tx, Rx and GND line must be connected between the COMM Ports of the master and remote unit. If this parameter is disabled the  key will have no effect on the master indicator.	Enable* / Disable
P288.01	<i>Digit</i>	Enables or disables the use of the numeric keys on the master indicator including the decimal key. When this parameter is enabled and a numeric key is pressed, it will be recognized by the master indicator. The Tx, Rx and GND line must be connected between the COMM Ports of the master and remote unit. If this parameter is disabled the numeric keys will have no effect on the master indicator.	Enable* / Disable
P289.01	<i>Target</i>	Enables or disables the use of the  key on the master indicator. When this parameter is enabled and the key is pressed, a target key command will be recognized by the master indicator. The Tx, Rx and GND line must be connected between the COMM Ports of the master and remote unit. If this parameter is disabled the  key will have no effect on the master indicator. Model 355 I.S. only.	Enable* / Disable

DISPLAY (P271)

When set for *Display*, information will be displayed on the remote indicator exactly as it appears on the master indicator.

Set P271 for *Display* and configure all other remote display parameters (refer to Table 18). Configure the parameters in the master indicator (refer to Setup Master Indicator on page 85). Make sure that the wiring connections between the master and remote indicators are correct (refer to Remote Display Connections on page 19).

CUSTOM (P271)

When set for *Custom*, the master indicator will send customized information to be displayed on the remote indicator. A parameter or text data may be transmitted to the remote indicator on a continual or “on demand” basis.

Set P271 for *Custom* and set all other remote display parameters (refer to Table 18). Configure the parameters in the master indicator (refer to Setup Master Indicator on page 85). Make sure that the wiring connections between the master and remote indicators are correct (refer to Remote Display Connections on page 19). Follow the instructions below for configuring the master indicator.

1. Turn echo off at P290.
2. Set the transmit to be continuous at P210 (port 1) or P230 (port 2). This is the port going to the remote indicator.
3. Program custom transmit in the master indicator at P1000 (port 1) or P2000 (port 2). See the example below for instructions on programming a custom transmit.

FYI If time out is enabled (P270), then the transmit should be set for continuous at P210 or P230 and have stability disabled at P212 or P232

Example:

The master indicator will be active and the Net weight will be displayed on the remote indicator. The net and lb annunciators will illuminate. The codes for the annunciators will be entered as they are control codes (see Entering ASCII Control Codes on page 51). The address of the remote indicator at P272 is 4. If P272 is set to *None!*, do not enter anything for the address field.

Access custom transmit 1 (P1000) or custom transmit 2 (P2000).

Format String:

If P274 and P275 = 1 – 255

<Start Character>, <Address>, <Annunciator 1>, <Annunciator 2>, <Parameter>, <End Character>

~or~

If P274 or P275 = 0

<Address>, <Annunciator 1>, <Annunciator 2>, <Parameter>, <Line Feed>

Custom Transmit :

1. or - <Start Character>
2. or - <Address>
3. or - <Annunciator 1>
4. or <Annunciator 2>
5. or , , or , , or - <Net Parameter>
6. or - <End Character>
7. Save changes and exit the setup mode.

ASCII Code	128	64	32	16	8	4	2	0
Annunciator 1		Good2	Gross	Net	Qty	Other	kg	
Annunciator 2		lb	Spt 1	Spt 2	Spt 3	→ 0 ←	Motion	

The start character and end character can be any ASCII character 1 - 255. Refer to Table 19 for the annunciator codes to be entered in the custom transmit. Always use 160 for the format code when entering a parameter.

Control (Hazardous Area) to Hub (Safe Area) Configuration

In order to use setpoints or analog output modules they must be located in the safe area. These modules will be installed in the safe area hub. Refer to Safe Area Setpoint Option Installation (Model 355 Hub Only) or Safe Area Analog Option Installation on page 24 for option installation instructions. The control indicator will be in the hazardous area and where the load cell(s) will be connected. The control and hub indicators will communicate via fiber optic cable. Refer to Fiber-Optic Interface on page 20 for installation instructions.

Use the following instructions to setup the control and hub indicators. Once a **control** or **hub** indicator is chosen at P260, the protocol and interactive parameters are automatically set up. See Table 19 for the default parameters of the **control** and **hub**. The setpoint and analog output parameters are only set in the control indicator (refer to Setpoint Setup on page 55 or Analog Output Setup on page 82). The hub indicator will echo the control indicator.

Make sure the controller and hub are connected with the fiber-optic kit and fiber-optic cable. Setup the **hub** indicator first and either cycle power or enter then exit the setup mode. This will synchronize P176, P177, P61200 – P61205.

Simple Setup (Hub Indicator):

1. Set P260 for **Hub**.
2. Exit the setup mode.



Simple Setup (Control Indicator):

1. Set P260 for **Ctrl**.
2. Exit the setup mode.

Table 19: Default Control and Hub Parameters

Parameter	Setting	Control / Hub
P171	Ignored	hub
P220	Baud Rate - 57600	control / hub
P221	Data bits - 8 data bits	control / hub
P222	Parity - no parity	control / hub
P223	Stop bit - on stop bit	control / hub
P224	Flow control - Xon / Xoff	control / hub
P261	Receive from control or master - port 2	hub
P270	Time out - enabled	hub
P271	Echo style - display	hub
P272	Address – none	hub
P273	Transmit non displayed data - port 1	hub
P274	Start character – 2	hub
P275	End character – 3	hub
P276	Pass through to master – enabled	hub
P277	Remote start key – enabled	hub
P278	Remote stop key – enabled	hub
P280	Remote zero key – enabled	hub
P281	Remote units key – enabled	hub
P282	Remote select key – enabled	hub
P283	Remote ID key – enabled	hub
P284	Remote print key – enabled	hub
P285	Remote tare key – enabled	hub
P286	Remote enter key – enabled	hub
P287	Remote clear key – enabled	hub

Parameter	Setting	Control / Hub
P288	Remote numeric and decimal key – enabled	hub
P289	Remote target key – enabled	hub
P291	Start character - 2	control
P292	End character - 3	control
P296	Remote style - 300	control

The parameters of the hub indicator may be overridden by keying in $\boxed{2}\boxed{9}\boxed{9}$  at P260. The parameters of the control indicator may be overridden by keying in $\boxed{3}\boxed{9}\boxed{9}$  at P260. Refer to Table 19 on page 89 for the parameters available for the hub.

Each time the **hub** indicator is powered up, the display may show *Hub*. Once motion is seen, the display will echo the **control** unit. Setpoints and analog outputs on **hub** are updated within 1 second or on the actual change in state even if **hub** is showing.

300 Series Command Codes

It is possible to send commands through the serial port to perform specific tasks.

Table 20: Single Keystrokes

Hex	Decimal	Symbol	Percent equivalent	Master / Remote	Action
0	0	NULL	none	M	As part of an echo used to indicate character information starting at 1 st of 10 characters
1	1	SOH	none	M	As part of an echo used to indicate character information starting at 2 nd of 10 characters
2	2	STX	none	M	Used to begin an echo OR as part of an echo used to indicate character information starting at 3 rd of 10 characters
3	3	ETX	none	M	Normally to end an echo OR as part of an echo used to indicate character information starting at 4 th of 10 characters
4	4	EOT	none	M	As part of an echo used to indicate character information starting at 5 th of 10 characters.
5	5	ENQ	none	M	As part of an echo used to indicate character information starting at 6 th of 10 characters.
6	6	ACK	none	M	As part of an echo used to indicate character information starting at 7 th of 10 characters.
7	7	BEL	none	M	As part of an echo used to indicate character information starting at 8 th of 10 characters.
8	8	BS	none	M	Backspace OR as part of an echo used to indicate character information starting at 9 th of 10 characters.
9	9	HT	none	M	As part of an echo used to indicate character information starting at 10 th of 10 characters.
A	10	LF	none	M	As part of an echo used to indicate numeric display information.
D	13	CR or CTL-M	none	M	Clear Key (clears user input or can initiate an action). As part of an echo used to indicate annunciator & display toggle scheme information.
11	17	CTL-Q	none	M/R	Xon
13	19	CTL-S	none	M/R	Xoff

Hex	Decimal	Symbol	Percent equivalent	Master / Remote	Action
81	129		%[Ctrl-A]	M	Target Key
85	133		%[Ctrl-E]	M	Start Key
86	134		%[Ctrl-F]	M	Stop Key
95	149		%[Ctrl-U]	M	Echo display (all 3 lines) out comm. 1
96	150		%[Ctrl-V]	M	Echo display (all 3 lines) out comm. 2
B9	185		%9	M	Enters the number before the %9 as the piece weight
D0	208		%P	M	Pause
D0	208		%Q	M	Send out transmits one and two
D2	210		%R	M	Remote Key 2
E0	224		%'	M	Backward Select
E3	227		%c	M	Clear Key (clears user input or can initiate an action)
E5	229		%e	M	Enter Key
E9	233		%i	M	ID Key (Print & Units on 350)
EF	239		%o	M/R	Turn off 350 I.S.
F0	240		%p	M	Print Key/ Arrow Up Key
F2	242		%r	M	Remote Key 1
F3	243		%s	M	Select Key
F4	244		%t	M	Tare Key
F5	245		%u	M	Units Key/ Right Arrow Key
F6	246		%v	M/R	Enter Setup
F8	248		%x	M	[Print][Select] Keys - Extended Resolution Gross
FA	250		%z	M	Zero Key

Table 21: Multiple Keystrokes

Hex	Decimal	Symbol	Percent equivalent	Master / Remote	Action
[Z] [CR]			%z	M	Zero Key (weigh mode only)
[W] [CR]			%p	M	Print Key (weigh mode only)
[P] [CR]			%p	M	Print Key (weigh mode only)

Display Capture Utility

The Display Capture Utility sends the current display information out of the one of the available comm ports when the one of the two extended ASCII character represented by decimal 149 (hex: 95h) or decimal 150 (hex: 96h) are received through the comm port. The previous characters can be used when the comm. port is set to 8 data bits. For 7 data bits comm. port, %[Ctrl-U] or %[Ctrl-V] can be used to replace 149 or 150 respectively. Upon receiving decimal 149, the Display Capture Utility sends the current display information out of comm. port 1. Upon receiving decimal 150, the Display Capture Utility sends the current display information out of comm. port 2. Entering a decimal 149 from a computer keyboard can be accomplished by turning on the Num Lock and holding down the ALT key while typing the desired decimal number on the keyboard keypad (for example, <Alt>149).



The Display Capture Utility must have NTEP disabled in order to function.

Example #1

The scale is in the weigh mode with the gross weight displayed (for example, 15.00).

Input: The extended ASCII character represented by decimal 149 (hex: 95h) is received through any comm port.

Output: “15.00 lb Gross ” is sent out comm port 1.

Example #2

The scale is in setup at P110 Full Scale.

Input: The extended ASCII character represented by decimal 150 (hex: 96h) is received through any comm port.

Output: “P110 F.S. 100.00 ” is sent out comm port 2.



Chapter 4: Calibration

This chapter covers all methods of calibration.

Setup Mode Calibration

You can enter the Calibration Mode after accessing the Setup Mode to view and/or change parameter settings (see *Setup Mode* on page 32).







To access the Calibration Mode when viewing any setup parameter:

1. From the Setup Mode, press .
DISPLAY READS ► *Enter ~ =Cal!*
2. Press  or .
DISPLAY READS ► *First ~ Zero? ~ -0.26*











Fast Calibration

Fast Calibration allows calibration of the Model 350/355 I.S. scale system without accessing the Setup Mode.

To access Fast Calibration from the Weigh Mode (350 I.S.):

1. From the Weigh Mode, press  +  .
DISPLAY READS ► *Setup~Enter ~ Code!*
2. Press  →  →  →  .
DISPLAY READS ► *Fast ~ Cal!~First ~ Zero? ~ -0.26*

To access Fast Calibration from the Weigh Mode (355 I.S.):

1. From the Weigh Mode key in   .
DISPLAY READS ► *Setup~Enter ~ Code!*
2. Key in   .
DISPLAY READS ► *Fast ~ Cal!~First ~ Zero? ~ -0.26*



Fast Calibration can also be accessed if the following data stream is received via the comm port:

```
100%s54321%e
```

Performing Calibration

Calibration always begins by establishing a zero (no-load) reference. A complete calibration also requires establishing a span (test load) reference. This section details various methods for obtaining zero and span references.



Press  or  during calibration to back up one step in the procedure.

Establishing Zero

The Model 350/355 I.S. provides five methods for obtaining a zero (no load) calibration reference, First Zero, Last Zero, False Zero, Only Zero, and Cal Reset.

To select a calibration method (350 I.S.):

1. Press **ZERO CLR** + **SELECT ON** to display the calibration prompt.
2. Press **ZERO CLR** → **PRINT** → **UNITS** → **TARE** to access the Calibration Mode.
3. Press **SELECT ON** to scroll through the five selections.
4. Press **TARE** to establish zero.

To select a calibration method (355 I.S.):

1. Press **1** **0** **0** **SELECT** to display the calibration prompt.
2. Press **5** **4** **3** **2** **1** **SAMPLE ENTER** to access the Calibration Mode.
3. Press **SELECT** to scroll through the five selections.
4. Press **SAMPLE ENTER** to establish zero.

First Zero















The most common zeroing procedure, First Zero is used to establish a new zero (no load) calibration reference before proceeding to span the Model 350/355 I.S.. Use this method for first-time calibration and complete recalibration.

First Zero Calibration Method Example (350 I.S.):

1. From the Weigh Mode, press **ZERO CLR** + **SELECT ON**.
DISPLAY READS ► Setup
2. Press **ZERO CLR** → **PRINT** → **UNITS** → **TARE**.
DISPLAY READS ► Fast ~ Cal~First ~ Zero? ~ -0.26
3. Remove any load on the scale.
DISPLAY READS ► First ~ Zero? ~ -0.42
4. Press **TARE** to establish zero.
DISPLAY READS ► 0.00
5. Pause for motion delay.
DISPLAY READS ► Enter ~ Load ~ 0.00
6. Place a 100lb test weight on scale.
DISPLAY READS ► Enter ~ Load ~ 99.66
7. Enter 100.
DISPLAY READS ► 100
8. Press **TARE** to establish span.
DISPLAY READS ► 100.00
9. Pause for motion delay.
DISPLAY READS ► Cal ~ Good? ~ 100.00
10. Press **TARE** to accept calibration.
DISPLAY READS ► Enter ~ =Stor
11. Press **TARE** to save calibration.
DISPLAY READS ► Enter ~ =End

12. Press  to exit calibration.
DISPLAY READS ► 100.00
13. Remove the calibration weight.
DISPLAY READS ► 0.00

First Zero Calibration Method Example (355 I.S.):

1. From the Weigh Mode key in  .
- DISPLAY READS ► Setup**
2. Key in  .
- DISPLAY READS ► Fast ~ Cal~First ~ Zero? ~ -0.26**
3. Remove any load on the scale.
DISPLAY READS ► First ~ Zero? ~ -0.42
4. Press  to establish zero.
DISPLAY READS ► 0.00
5. Pause for motion delay.
DISPLAY READS ► Enter ~ Load ~ 0.00
6. Place a 100lb test weight on scale.
DISPLAY READS ► Enter ~ Load ~ 99.66
7. Enter 100.
DISPLAY READS ► 100
8. Press  to establish span.
DISPLAY READS ► 100.00
9. Pause for motion delay.
DISPLAY READS ► Cal ~ Good? ~ 100.00
10. Press  to accept calibration.
DISPLAY READS ► Enter ~ =Stor
11. Press  to save calibration.
DISPLAY READS ► Enter ~ =End
12. Press  to exit calibration.
DISPLAY READS ► 100.00
13. Remove the calibration weight.
DISPLAY READS ► 0.00

Last Zero

The Last Zero procedure allows recalibration of the weighing device using an existing test load. This is especially beneficial when checking high capacity applications such as tank weighing to minimize the task of placing and removing test weights.



Establish gross zero *before* entering setup or calibration!

Last Zero Calibration With Weight Already Applied Example (350 L.S.):

1. Remove any load on the scale.
DISPLAY READS ► 10.
2. Press **ZERO CLR** to zero the scale.
DISPLAY READS ► 00.
3. Apply a 10000 lb test weight to verify calibration.
DISPLAY READS ► 9970.
4. Press **ZERO CLR** + **SELECT ON**.
DISPLAY READS ► Setup
5. Press **ZERO CLR** → **PRINT** → **UNITS** → **TARE**.
DISPLAY READS ► Fast ~ Cal~First ~ Zero? ~ 9930.
6. Press **SELECT ON**.
DISPLAY READS ► Last ~ Zero? ~9930.
7. Press **TARE** to use last zero.
DISPLAY READS ► Enter ~ Load? ~ 9970.
8. Enter 10000.
DISPLAY READS ► 10000
9. Press **TARE** to establish span.
DISPLAY READS ► 10000.
10. Pause for motion delay.
DISPLAY READS ► Cal ~ Good? ~ 10000.
11. Press **TARE** to accept calibration.
DISPLAY READS ► Enter ~ =Stor
12. Press **TARE** to save calibration.
DISPLAY READS ► Enter ~ =End
13. Press **TARE** to exit calibration.
DISPLAY READS ► 10000.
14. Remove the calibration weight.
DISPLAY READS ► 0.

Last Zero Calibration With Weight Already Applied Example (355 L.S.):

1. Remove any load on the scale.
DISPLAY READS ► 10.
2. Press **ZERO** to zero the scale.
DISPLAY READS ► 00.
3. Apply a 10000 lb test weight to verify calibration.
DISPLAY READS ► 9970.
4. Press **1** **0** **0** **SELECT**.
DISPLAY READS ► Setup
5. Press **5** **4** **3** **2** **1** **SAMPLE ENTER**.

DISPLAY READS ► *Fast ~ Cal~First ~ Zero? ~ 9930.*

6. Press .

DISPLAY READS ► *Last ~ Zero? ~9930.*

7. Press  to use last zero.

DISPLAY READS ► *Enter ~ Load? ~ 9970.*

8. Enter 10000.

DISPLAY READS ► *10000*

9. Press  to establish span.

DISPLAY READS ► *10000.*

10. Pause for motion delay.

DISPLAY READS ► *Cal ~ Good? ~ 10000.*

11. Press  to accept calibration.

DISPLAY READS ► *Enter ~ =Stor*

12. Press  to save calibration.

DISPLAY READS ► *Enter ~ =End*

13. Press  to exit calibration.

DISPLAY READS ► *10000.*

14. Remove the calibration weight.

DISPLAY READS ► *00.*

False Zero

False Zero calibrates the Model 350/355 I.S. without removing the current gross weight. This is particularly useful in tank weighing applications where it may be both time consuming and costly to completely empty the tank. This operation is achieved by establishing a false (temporary zero) zero reference. Test weights may then be added to verify calibration. The zero reference determined during the last calibration is not affected.

False Zero Calibration Without Removing Existing Load Example (350 I.S.):

1. Press  + .

DISPLAY READS ► *Setup*

2. Press  →  →  → .

DISPLAY READS ► *Fast ~ Cal~First ~ Zero? ~ 5075.*

3. Press  .

DISPLAY READS ► *False ~ Zero? ~5075.*

4. Press  to establish false (temporary) zero.

DISPLAY READS ► *Units ~ =lb*

5. Pause to display calibration units.

DISPLAY READS ► *Enter ~ Load? ~ 00.*

6. Place a 2500lb test weight on scale.

DISPLAY READS ► *Enter ~ Load? ~ 2510.*

7. Enter 2500.

DISPLAY READS ► 2500

8. Press  to establish span.

DISPLAY READS ► 2500.

9. Pause for motion delay.

DISPLAY READS ► Cal ~ Good? ~ 2500.

10. Press  to accept calibration.

DISPLAY READS ► Enter ~ =Stor

11. Press  to save calibration.

DISPLAY READS ► Enter ~ =End

12. Press  to exit calibration.

DISPLAY READS ► 5055.

13. Remove the calibration weight.

DISPLAY READS ► 00.

False Zero Calibration Without Removing Existing Load Example (355 I.S.):

1. Press    .

DISPLAY READS ► Setup

2. Press      .

DISPLAY READS ► Fast ~ Cal~First ~ Zero? ~ 5075.

3. Press  .

DISPLAY READS ► False ~ Zero? ~5075.

4. Press  to establish false (temporary) zero.

DISPLAY READS ► Units ~ =lb

5. Pause to display calibration units.

DISPLAY READS ► Enter ~ Load? ~ 00.

6. Place a 2500lb test weight on scale.

DISPLAY READS ► Enter ~ Load? ~ 2510.

7. Enter 2500.

DISPLAY READS ► 2500

8. Press  to establish span.

DISPLAY READS ► 2500.

9. Pause for motion delay.

DISPLAY READS ► Cal ~ Good? ~ 2500.

10. Press  to accept calibration.

DISPLAY READS ► Enter ~ =Stor

11. Press  to save calibration.

DISPLAY READS ► Enter ~ =End

12. Press  to exit calibration.

DISPLAY READS ► 5055.













13. Remove the calibration weight.

DISPLAY READS ► 00.

















Only Zero

Only Zero is used to establish a new calibration zero without affecting the span. This is useful for correcting changes to the scale's dead load, for example adding safety rails to a truck scale platform.

Only Zero Calibration Example (350):

1. From the Weigh Mode, press  + .
- DISPLAY READS ► Setup**
2. Press  →  →  → .
- DISPLAY READS ► Fast ~ Cal~First ~ Zero? ~2640.**
3. Press   .
- DISPLAY READS ► Only ~ Zero? ~ 2640.**
4. Remove any load on the scale.
- DISPLAY READS ► Only ~ Zero? ~ 2620.**
5. Press  to establish zero.
- DISPLAY READS ► 00.**
6. Pause for motion delay.
- DISPLAY READS ► Cal ~ Good? ~ 00.**
7. Press  to accept calibration.
- DISPLAY READS ► Enter ~ =Stor**
8. Press  to save calibration.
- DISPLAY READS ► Enter ~ =End**
9. Press  to exit calibration.
- DISPLAY READS ► 00.**

Only Zero Calibration Example (355 I.S.):

1. From the Weigh Mode, press    .
- DISPLAY READS ► Setup**
2. Press      .
- DISPLAY READS ► Fast ~ Cal~First ~ Zero? ~2640.**
3. Press   .
- DISPLAY READS ► Only ~ Zero? ~ 2640.**
4. Remove any load on the scale.
- DISPLAY READS ► Only ~ Zero? ~ 2620.**
5. Press  to establish zero.
- DISPLAY READS ► 00.**
6. Pause for motion delay.
- DISPLAY READS ► Cal ~ Good? ~ 00.**
7. Press  to accept calibration.
- DISPLAY READS ► Enter ~ =Stor**
8. Press  to save calibration.
- DISPLAY READS ► Enter ~ =End**

9. Press  to exit calibration.



DISPLAY READS ► 00.

Reset Calibration













Cal Reset may be necessary when an over-load or under-load condition exists, preventing the completion of the calibration process. Calibration Reset adjusts the zero and gain factors of the A/D amplifier to factory default values for maximum sensitivity.



After performing a calibration reset, a complete recalibration is required. The effects of a calibration reset do not take effect until the Model 350/355 is recalibrated and calibration information has been saved.



















If *Code 02* (under-load) or *Code 03* (over-load) is displayed during calibration, press  or  to perform a calibration reset.

Reset Calibration Gain Factors Example (350 I.S.):

1. Press  + .
- DISPLAY READS ► Setup**
2. Press  →  →  → .
- DISPLAY READS ► Fast ~ Cal~First ~ Zero? ~ xx.xx**
3. Remove any load on the scale.
DISPLAY READS ► First ~ Zero? ~ xx.xx
4. Press  to establish zero.
DISPLAY READS ► Enter ~ Load? ~ 0.00
5. Place a 100lb test weight on scale.
DISPLAY READS ► Code03
6. Press .
- DISPLAY READS ► First ~ Zero? ~ -0.26**
7. Remove any load on the scale.
DISPLAY READS ► First ~ Zero? ~ -0.42
8. Press  to establish zero.
DISPLAY READS ► 0.00
9. Pause for motion delay.
DISPLAY READS ► Enter ~ Load ~ 0.00
10. Place a 100lb test weight on scale.
DISPLAY READS ► Enter ~ Load ~ xx.xx
11. Enter 100 with the  and  keys.
DISPLAY READS ► 100
12. Press  to establish span.
DISPLAY READS ► 100.00
13. Pause for motion delay.
DISPLAY READS ► Cal ~ Good? ~ 100.00

14. Press  to accept calibration.
DISPLAY READS ► *Enter ~ =Stor*
15. Press  to save calibration.
DISPLAY READS ► *Enter ~ =End*
16. Press  to exit calibration.
DISPLAY READS ► *100.00*
17. Remove the calibration weight.
DISPLAY READS ► *0.00*

Reset Calibration Gain Factors Example (355 I.S.):

1. Press    .
- DISPLAY READS ► *Setup***
2. Press      .
- DISPLAY READS ► *Fast ~ Cal~First ~ Zero? ~ xx.xx***
3. Remove any load on the scale.
DISPLAY READS ► *First ~ Zero? ~ xx.xx*
4. Press  to establish zero.
DISPLAY READS ► *Enter ~ Load? ~ 0.00*
5. Place a 100lb test weight on scale.
DISPLAY READS ► *Code03*
6. Press .
- DISPLAY READS ► *First ~ Zero? ~ -0.26***
7. Remove any load on the scale.
DISPLAY READS ► *First ~ Zero? ~ -0.42*
8. Press  to establish zero.
DISPLAY READS ► *0.00*
9. Pause for motion delay.
DISPLAY READS ► *Enter ~ Load ~ 0.00*
10. Place a 100lb test weight on scale.
DISPLAY READS ► *Enter ~ Load ~ xx.xx*
11. Enter   .
- DISPLAY READS ► *100***
12. Press  to establish span.
DISPLAY READS ► *100.00*
13. Pause for motion delay.
DISPLAY READS ► *Cal ~ Good? ~ 100.00*
14. Press  to accept calibration.
Enter ~ =Stor
15. Press  to save calibration.
DISPLAY READS ► *Enter ~ =End*

16. Press  to exit calibration.

DISPLAY READS ► 100.00

17. Remove the calibration weight.









DISPLAY READS ► 0.00

Multi-Point Linearization











If the load cell signal input to the indicator has good repeatability and stability, then using multi-point linearization during calibration may significantly improve the ultimate accuracy of the data displayed by the indicator. Parameter 119 (P119) enables or disables this feature. Initially, the same basic procedures as a normal calibration are used to perform a multi-point linearization. All of the prompts provided will be exactly the same as a standard calibration for each cal point up to the *Cal ~ Good?* prompt.



If items are consistently being weighed on either the high or low end of the cell capacity, the points of calibration can be skewed to either end of the spectrum. Multi-point linearization can compensate for a cell that is non-linear. Refer to page 94 for the instructions on how to enter the calibration mode.





First Zero?



1. Remove all weight and press  or .
2. From the *Enter Load* prompt key in the first calibration point and press  or .
3. From the *Add Load* prompt add the weight of the first calibration point and press  or .
4. For calibration points 2 –5; Simply add the weight which you want to use for the next calibration point, then key in the value of the applied weight and press  or . You may wish to add weight until the displayed weight differs from the actual applied weight and then perform the next calibration at that point.



Reset Cal

1. Press  or .
2. From the *First Zero?* prompt remove all weight and press  or .
3. From the *Enter Load* prompt key in the first calibration point and press  or .
4. From the *Add Load* prompt add the weight of the first calibration point and press  or .
5. For calibration points 2 –5; Simply add the weight which you want to use for the next calibration point, then key in the total applied weight and press  or . You may wish to add weight until the displayed weight differs from the actual applied weight and then perform the next calibration at that point.

Up to five calibration points may be established using this procedure. However if fewer calibration points are required, simply press  or  without entering a value at the **PntX** prompt. Refer to Figure 24 for graph examples of 5 point calibration.

After the last point is established, the indicator will prompt with *Cal ~ Good?* Press the  or  key to accept the calibration or press  or  to backup and redo the last point as described below.

If you make a mistake at any point in the linearization process, simply press the  or  key. The indicator will backup one step in the procedure to the previous linearization point.

After the linearization has been completed, the changes must be saved by pressing  or  at the *Enter = Save* prompt. Otherwise the previous calibration data will remain in effect.

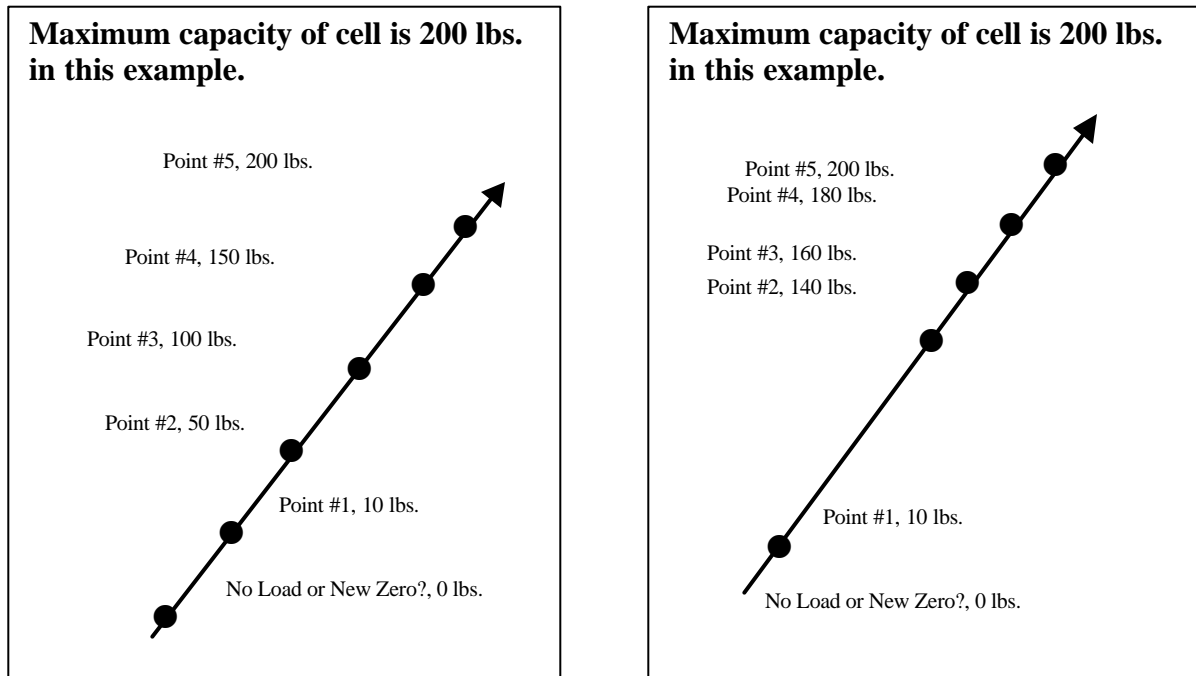



Figure 24: Multi - Point Linearization Charts

Examining Calibration Results

If Multi-Point Linearization is enabled (P119), the ten Parameters **P61130** thru **P61139** show the calibration weights used and the resulting calculated factors. Otherwise the message **Not Used** is displayed.

Establishing A Span



Once a zero reference has been established, the Model 350/355 I.S. displays *Enter ~ Load* and awaits the entry of a span (test load) value. This value may be entered before or after the test load has been applied.



If the calibration weight value was entered before applying the test weight, *Add ~ Load* is displayed indicating that the test weight should now be applied. Apply the test weight, press  or  and proceed to *Exiting Calibration* on page 105.

If it is necessary to repeat the calibration process, press  at the *Cal ~ Good?* prompt and repeat the calibration process.

Establishing span with a 100lb test weight:

1. Place a 100lb test weight on scale.







- DISPLAY READS ► *Enter ~ Load ~ xx.xx***
- Enter 100.
DISPLAY READS ► 100
 - Press  or  to establish span.
DISPLAY READS ► 100.00
 - Pause for motion delay.
DISPLAY READS ► *Cal ~ Good? ~ 100.00*

When making a significant change to the previous calibration, or when the calibration weight is less than 5% of full scale capacity, *ReCal ~ ???* will be displayed instead of *Cal ~ Good?* In this event it is recommended that the calibration be performed a second time. Press  or  to recalibrate, or press  to skip recalibration.







Exiting Calibration

Once zero and span have been established, the newly acquired calibration information must be saved to non-volatile memory before it will be realized in the Weigh Mode.

To exit and save calibration information:

- Press  or  to accept calibration.
DISPLAY READS ► *Enter ~ =Stor*
- Press  or  to save calibration.
DISPLAY READS ► *Enter ~ =End*
- Press  or  to exit calibration.
DISPLAY READS ► 100.00

To exit without saving calibration information:

- Press  or  to accept calibration.
DISPLAY READS ► *Enter ~ =Stor*
- Press .
- Press  or .
- Press  or  to exit calibration.
DISPLAY READS ► 99.66



When saving calibration, parameters changed in the Setup Mode are also saved with their new selections.

Chapter 5: Legal For Trade

The Model 350/355 I.S. default parameter setup does not ensure compliance with legal-for-trade installations as mandated by local weights and measures authorities. This chapter contains information on NTEP and OIML regulations, sealing and audit trails, and other requirements.

Since legal-for-trade requirements may vary, you must ensure that the Model 350/355 I.S. is installed in accordance with all local regulations.

NTEP Requirements

The National Type Evaluation Program (NTEP) is a widely accepted weights and measures standard in the United States, with most states abiding by some or all of the NTEP requirements. A complete list of these regulations is available in the “Handbook 44” publication distributed by the National Institute of Standards and Technology (NIST). For more information, call (301) 975-3058, or visit <http://www.nist.gov>.



The Model 350/355 I.S. NTEP Certificate of Conformance (C.O.C.) is 98-092A3.

In order to configure the Model 350/355 I.S. to comply with NTEP requirements, parameter P440-rstrc (*restrict*) must be enabled. This ensures the following:

- Serial data will not be received while in the Setup Mode.
- Received alpha characters will not be displayed.
- Numeric tare entries cannot be received through the serial port.
- Pressing  with a gross weight of zero (0) will not automatically switch to the net mode.
- Negative tare values are not accepted.
- Tare rounding is enforced.
- When the tare value is zero, the net mode is not selectable.

Where applicable, enabling the *restrict* parameter will over-ride the current setting of other parameters.

OMIL Requirements

The International Organization of Legal Metrology is an inter-governmental body which harmonizes the national metrology regulations of its world wide members. A list of regulation publications may be obtained from the Bureau International de Métrologie Légale (BIML) in Paris, France.

In order to configure the Model 350 I.S. to comply with OIML requirements, parameter P410-Euro must be enabled. Doing so will ensure the following:

- An over-load condition will result when the gross weight exceeds nine graduations over the full scale capacity.



If the counting feature is enabled, NTEP requires a label on the front of the indicator stating “*The counting feature is not legal for trade*”.

- Full scale capacity is always referenced from the last zero calibration reference, not the last zero acquired by pressing .

Most NTEP requirements will also apply. See the *Other Requirements* section below for additional considerations.

Other Requirements

Several parameters must be considered on an individual basis as their configuration may vary with different applications. These parameters include, but are not limited to:

Parameter	Description	Comment
P110	Full Scale Capacity	Verify proper scale capacity.
P111	Division Size	Verify that the maximum allowable number of scale divisions are not exceeded.
P112	Zero Track	Verify required selection.
P114	Stability	Verify required selection.

Parameter	Description	Comment
P118	Zero Range	Verify required selection.
P212	Print Stability	Verify required selection.

Sealing And Audit Trails

Most legal-for-trade installations will require the Model 350/355 I.S. to be sealed. A sealed indicator cannot be accessed for setup or calibration changes without breaking a physical seal or incrementing an event counter, thus providing evidence of tampering.

The Model 350/355 I.S. has two types of sealing provisions; a physical seal and a three-event audit trail counter. Check with your local weights and measures authority to determine your requirements.

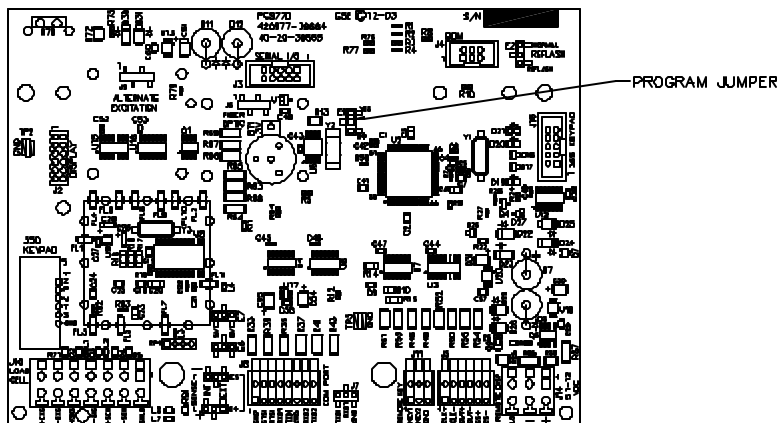

Figure 25: Model 350/355 I.S. Program Jumper (E1)

Physical Seal

The most common sealing method is a lead-wire seal. The Model 350 I.S. and Model 355 I.S. provide an easy means of applying this type of seal as shown in Figure 26. Before applying a wire seal, move the program jumper to the 'NO' position as shown in Figure 25. This will prevent access to the Setup and Calibration Modes.

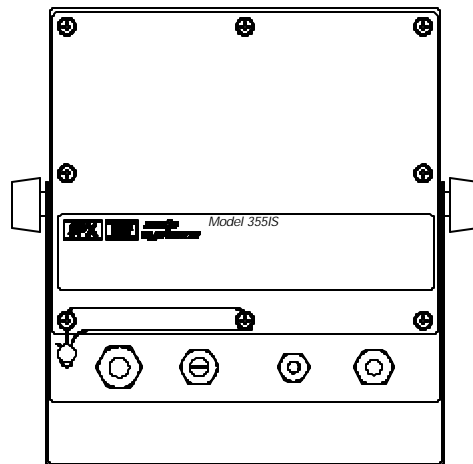

Figure 26: Model 350/355 I.S. Physical Seal

Audit Trails

Three separate incrementing, non-resettable audit trail parameters are used by the Model 350/355 I.S. to indicate changes to various parameters, P60201 – OIML, P60203 – Calibration, P60204 – Setup, and P65001 or P65002 – OIML, Calibration, and Setup. An audit trail counter will increment only once upon reflashing the indicator with new firmware, or exiting the Setup Mode and saving changes regardless of how many settings were changed.

OIML Audit Trail

Changes to any of the following parameters will increment the OIML (Euro) audit trail at P60201:

- P110 – P118 (scale setup)
- P150 (default units)
- P151 (units enable)
- P410 (Euro enable)
- P440 (rStrc enable)
- Existing Calibration
- Loading new Firmware (i.e. updates) by reflashing the indicator.

Calibration Audit Trail

Any changes to the existing calibration will increment the Calibration (CAL) audit trail at P60203.











Setup Audit Trail

Changes to any of the Setup Mode parameters will increment the setup audit trail at P60203.

Viewing Audit Trail Parameters

Audit trail parameters may be viewed at any time.

To view audit trail parameters: (Model 350 I.S.)

1. Press  + .
- DISPLAY READS ► Setup~Enter ~ Code!**
2. Press  →  →  → .
- DISPLAY READS ► -No- ~ Chgs!~P112 ~ FS ~ xx.xx**
3. Enter [60203] with the  and  keys.
- DISPLAY READS ► 60203**
4. Press  to view the selected audit trail.
- DISPLAY READS ► Audit ~ Trail~CAL. ~ 00001**
5. Press  to return to the Weigh Mode.
- DISPLAY READS ► 0.00**

To view audit trail parameters: (Model 355 I.S.)

1. Press    .
- DISPLAY READS ► Setup~Enter ~ Code!**

2. Press .

DISPLAY READS ► 60203

3. Press to view the selected audit trail.

DISPLAY READS ► *Audit ~ Trail~CAL. ~ 00001*

4. Press to return to the Weigh Mode.

DISPLAY READS ► 0.00

Chapter 6: Troubleshooting

This chapter contains error messages and information parameters, as well as information on setup parameter selections and A/D Calibration.

Error Messages

The Model 350/355 I.S. utilizes the following types of error messages: *Operational Errors, Setup Mode Errors, Hardware Errors, Calibration Errors, Communication Errors, and Miscellaneous Errors.*

Operational Errors

Code02	Under Load. Input signal is less than negative full scale. Check load cell wiring. Verify correct capacity selection at P110.
Code03	Over Load. Input signal is greater than positive full scale. Use same checks as “under load” above.
Funct ~ Disbl	Attempted to perform a function disabled in the Setup Mode.
Code 04	The digits on the display have exceeded the six digit display capacity.
Code 05	Zero attempted beyond that allowed by P118.
Code 08	Input signal greatly exceeds the valid range. Check the load cell connection.
Tare ~ Error	Negative tare attempted when disabled (P440 enabled).
Tare ~ GT FS	Tare value greater than full scale capacity.
Delay	Indicates that a motion delay is in effect (zero, tare, etc.).
Delay ~ Abort	Acknowledges that a motion delayed function was aborted.
Print ~ Abort	Acknowledges that a motion delayed print request was aborted.
Add ~ Load!	If displayed after performing a count sample, this message indicates that a larger sample size is required.
Out of ~ Range	Attempted to enter a value beyond the allowable range.
SPTxx ~ Error	A conflict occurred with a setpoint value entry (example: target entry is less than preact). The digits ‘xx’ represent the last two digits of the setpoint parameter in error (example: SPT 5 ~ Error indicates a conflict at P510 <u>5</u> , preact 1).
Need APS	A setpoint start is initiated and the setpoint is based on quantity and no piece weight has been established (start will not occur).
Edit Disbl	Unable to edit the time and date because P502 is disabled.

Setup Mode Errors

Bad ~ Code!	An incorrect access code was entered.
Unit ~ Seald	Access to the Setup or Calibration Mode was denied. Check the internal “YES/NO” program jumper.
Unit3-Ntep	Parameter 440 (NTEP) is enabled and parameter 152 (third unit) is set to an additional unit. The third unit is not NTEP approved.
Code 49.	
Entry ~ Error	An invalid entry was made.
Need ~ Entry	A numeric value was required before pressing  .
Out of ~Range	The entered value exceeded the allowable range.
Can't ~ Set!	Attempt to change a parameter that does not allow an entry.
ResGT ~ 260E3	The number of divisions exceeds 260000 (see P110, P111).
Code 35.	
ResGT ~ 25E3	The number of divisions exceeds 25000 (see P110, P111).
ResLT ~ 100!	The number of divisions is less than 100 (see P110, P111).
ResLT ~ 1 !!	Number of divisions is less than one (see P110, P111).
SPTxx ~ Error	A conflict occurred with a setpoint value entry (example: target entry is less than preact). The digits ‘xx’ represent the last two digits of the setpoint parameter in error (example: SPT 5 ~ Error indicates a conflict P510 <u>5</u> , preact 1).
Prctl ~ Error	Existing protocol is invalid. The following are not allowed: - P201 = 7 data bits, P202 = no parity, P203 = 1 stop bit - P201 = 8 data bits, P202 = even parity, P203 = 2 stop bits - P201 = 8 data bits, P202 = odd parity, P 203 = 2 stop bits
Reboot! ~ to chang baud	The current CPU speed at P60090 is low for the chosen baud rate.









Hardware Errors

Code00 A-D ~ Bad! Or Code17 Deflt ~ A-D	A FRAM problem detected during power-up. Problem with A/D chip detected. Disconnect any options installed and re-power the unit. Options are connected to the same serial lines as the A/D so they may prevent it from working properly. Bad A/D calibration values. Recalibrate A/D (see <i>A/D Calibration Procedure</i> on page 118).
Re- ~ Boot! Chec ~ E2 Deflt ~ Setup	FRAM data could not be read. Attempting power-up reset. FRAM data error. An error occurred when reading setup data from the FRAM during power-up. All parameters are set to factory default.
Ch.XXXX	A checksum error occurred during power-up. All annunciators are lit. The FRAM integrity test failed or is improperly seated.
E2 ~ Full! NoSpc ~ Free!	The FRAM setup exceeds the memory capacity. The current setup exceeds the setup RAM capacity.

Calibration Errors

F.S. ~ TooHi	The entered calibration weight will result in an over-capacity condition at full scale. Verify that the full scale (P110) and calibration weight value are correct.
F.S. ~ TooLo	The entered calibration weight will result in a full scale input signal less than the minimum allowed. Verify that the full scale (P110) and entered weight value are correct.
Add ~ Load! ReCal ~ ???	The calibration weight is less than 0.1% of capacity. More weight is required. Repeat the cal. procedure for accuracy. This prompt appears when the calibration weight is less than 5% of capacity, or when the A/D coarse gain is adjusted.
Entry ~ Error	An invalid entry was made.

Communication Errors

Par-Er Buf-Er	The selected parity (P202) does not match that of the connected device. The receive buffers capacity was exceeded. This indicates a handshaking problem. Check P204 and verify proper communication port connections.
Bit-Er	The stop bit of a received character did not occur when expected. Verify that protocol (P200 – P204) matches that of the connected device.
Trans~Hold1	Data transmission is inhibited due to a deasserted handshake on communication port 1. Press  or  to abort transmission. Check P204. If in a Control and Hub configuration, press  or  three times to clear the error.
Trans~Hold2	Data transmission is inhibited due to a deasserted handshake on communication port 2. Press  or  to abort transmission. Check P204. Check P204. If in a Control and Hub configuration, press  or  three times to clear the error.
Error~BaudX	The X being either comm port 1 or comm. port 2. The baud rate selected is too high for the microprocessor rate. Either set the baud rate lower or change the microprocessor rate at P60090 higher.



Miscellaneous Errors

T.X.YYYY	If catastrophic errors occur in the software, a trap error may occur and freeze the display with address information. (X = bank number and YYYY = the address of the trap error. Press any key five seconds after viewing message to reboot the unit).
-----------------	--





Viewing Setup

While troubleshooting it may be helpful to view the setup parameter selections. This can be done using the procedure below (even with the internal program jumper in the “NO” position). Note that accessing the Setup Mode in this manner will not permit parameter changes.

To view the setup parameter selections (350 I.S.):

1. From the Weigh Mode, press  + .
DISPLAY READS ► Setup~Enter ~ Code!
2. Press .
DISPLAY READS ► -No- ~ Chgs!~P110.-- ~ F.S.= ~ 100.0
3. Navigate the Setup Mode as described in *Setup Mode* on page 33.

To view the setup parameter selections (355 I.S.):

1. From the Weigh Mode, press  .
DISPLAY READS ► Setup~Enter ~ Code!
2. Press .
DISPLAY READS ► -No- ~ Chgs!~P110.-- ~ F.S.= ~ 100.0
3. Navigate the Setup Mode as described in *Setup Mode* on page 33.







To exit the Setup Mode:

1. Press .
2. Press .











Information Mode Parameters

A series of informational parameters are available beginning at P60000. These parameters may be accessed from the Setup Mode, or from the Weigh Mode as described below. Refer to Table 22 for an explanation of each information parameter.

To access the informational parameters (350 I.S.):

1. Press  + .
DISPLAY READS ► Setup~Enter ~ Code!
2. Press  →  →  → .
DISPLAY READS ► P60000 ~ E2Ins ~ 512
3. Navigate the Setup Mode as described in *Setup Mode* on page 33.









To access the informational parameters (355 I.S.):

4. Press  .
DISPLAY READS ► Setup~Enter ~ Code!
5. Press  .
DISPLAY READS ► P60000 ~ E2Ins ~ 512
6. Navigate the Setup Mode as described in *Setup Mode* on page 33.

As each information parameter is accessed, the parameter number is briefly displayed, followed by the parameter name, and finally the parameter value. To repeat the parameter number and name sequence, press **SELECT**. To exit the information mode, press **ZERO**.

Table 22: Information Parameters

PARAMETER	NAME	DESCRIPTION
60000	<i>E2Ins</i>	Total amount of FRAM storage.
60001	<i>E2Fre</i>	Amount of available FRAM storage.
60090	<i>SPEED</i>	Set and view the microprocessor speed. The higher the speed of the processor, the more power consumption. The default value is 3.69 MHz. Press the TARE key on the 350 I.S. or SAMPLE ENTER key on the 355 I.S. to change the value. The value will not take affect until power is cycled. View the current processor speed by pressing PRINT or UNITS .
60100	<i>-GSE- ~ c1998</i>	Copyright statement.
60101	<i>350 I.S. ~ 01001</i>	Firmware revision code.
60102	<i>02- 10 ~ 1998</i>	Firmware date code.
60200	<i>b sn ~ 10001</i>	Main circuit board serial number.
60201	<i>Audit ~ Trail Euro ~ 00000</i>	OIML (European) audit trail number (see <i>OIML Audit Trail</i> on page 110).
60202	<i>i sn ~ 00000</i>	Model 350/355 serial number.
60203	<i>Audit ~ Trail CAL. ~ 00000</i>	Calibration audit trail number (see <i>Calibration Audit Trail</i> on page 110).
60204	<i>Audit ~ Trail Setup ~ 00000</i>	Setup audit trail number (see <i>Setup Audit Trail</i> on page 110).
61100	<i>Load ~ Cell 0.00000</i>	Current mV/V output of the load cell.
61101	<i>Cal ~ Factr 1.00000</i>	Calibration factor for the load cell.
61102	<i>Rezro ~ Load 0.00000</i>	Amount of weight (in default units) zeroed through use of the ZERO key.
61103	<i>Zrtrc ~ Load 0.00000</i>	Amount of weight (in default units) zeroed by the zero track feature since ZERO was last pressed.
61104	<i>CZero ~ 0P</i>	Coarse zero calculated during calibration.
61105	<i>Fine ~ Zero 1738</i>	Fine zero calculated during calibration.
61106	<i>CGain ~ 50</i>	Coarse gain calculated during calibration.
61107	<i>Fine ~ Gain 1.00000</i>	Fine gain calculated during calibration.
61110 ↓ 61112	<i>Zero ~ Adj25 73741 ↓ Zero ~ Ad100 -21813</i>	A/D compensation for coarse zero.
61117 ↓ 61120	<i>AiN1 ~ NrOff -11035 ↓ AiN8 ~ NrOff -14800</i>	A/D non-ratio-metric offset compensation.
61121	<i>Vref ~ NrOff -12739</i>	A/D reference voltage compensation.
61122	Alt~E=8	Alt E=8 when the 8 volt excitation module is installed or Alt E=5 when 8 volt excitation module is not present.
61200	<i>10oFF</i>	Analog option 0 – 10V Zero offset value.
61201	<i>10Gn</i>	Analog option 0 – 10V Full scale gain value.
61202	<i>0oFF</i>	Analog option 0 – 20mA Zero offset value.
61203	<i>0Gn</i>	Analog option 0 – 20mA Full scale gain value.
61204	<i>4oFF</i>	Analog option 4 – 20mA Zero offset value.
61205	<i>4Gn</i>	Analog option 4 – 20mA Full scale gain value.
61206	<i>Srln</i>	Analog option board serial number.

PARAMETER	NAME	DESCRIPTION
62000	<i>Dsply ~ Test 8.8.8.8.8.8.</i>	Display test. Press  or  to illuminate all segments. Continue pressing  or  to cycle through various patterns.
62001	<i>Spt 1 ~ Disbl</i>	Allows setpoint status to be changed by pressing  or  while viewing this parameter. Requires that setup was entered using the access code.
62002	<i>Spt 2 ~ Disbl</i>	
62003	<i>Spt 3 ~ Disbl</i>	
62020	<i>AdAnl</i>	Displays the voltage of the AC to DC power supply. Refer to P62021 if a battery is used. This parameter will still show a voltage when battery powered. This voltage reading will be slightly lower than what is display at P62021.
62021	<i>AdbAt</i>	Displays the voltage level on the battery when battery powered. Will show 0 if AC powered.
64000	<i>Send ~ Setup</i>	Transmits all setup information out the communication port.
64100	<i>LnCnt ~ 0</i>	Received setup line count.
64101	<i>ErCnt ~ 0</i>	Received setup error count.
64102	<i>IstEr ~ None!</i>	Parameter of the first setup receive error.
65001	<i>Deflt ~ All</i>	Default All. Sets all parameters to factory default settings. Press  or  to initiate default.
65002	<i>Deflt ~ -CAL</i>	Same as above, except calibration is retained.
65020	<i>Re- ~ Flash</i>	Used for firmware upgrade. If  is pressed at P65020, the indicator's display will blank out and appear locked up. The only way to unlock this parameter is via a computer and terminal window software (ie. Communications Plus, Hyper terminal). See Upgrade Indicator Firmware on page 80 to upgrade firmware. To escape the firmware upgrade: 1) Connect a computer to the serial port and use a terminal program such as CommPlus. Set the computer protocol to 9600,8,1,none. 2) Power up the indicator and the reflash menu will show in the terminal window. 3) Press the d key on the computer keyboard to quit the reflash process. 4) The indicator will return to a usable state.

A/D Calibration Procedure

The Model 350/355 I.S. Analog-to-Digital Converter (A/D) is calibrated at the factory to ensure a stable, linear response to the load cell signal. This calibration procedure calculates critical values that are permanently stored in parameters P61110 – P61121. The A/D calibration should not be confused with the standard weight calibration. It should never be necessary to recalibrate the A/D. However, if the values stored at parameters P61110 – P61121 appear to be reset to 0.00000 and/or 1.00000, then A/D recalibration is necessary. Contact GSE Scale Systems or your local authorized GSE distributor for more information on this procedure.

Appendix A: Maintenance

The mainboard, keypad and display are the key components that may need to be replaced. All service, component replacement and repairs must be performed by qualified personnel. Before opening the indicator, make sure that all power is removed and the repair is done in a safe area. If it is necessary to replace the keypad or display, you must first remove the main board. Follow the instructions below to remove and reinstall the main board.

Main Board Replacement

It is possible that the main board may need to be replaced for a number of various reasons. Please consult with a factory representative before removing the main board.

Main Board Removal

1. Remove the (8) Phillips head screws from the back panel.
2. Separate the back panel from the front enclosure and set the back panel and screws aside. When the back panel is removed the main board will be visible.
3. Disconnect the wires for the loadcell (J10), power (J) and communications (J8) (if used). Unplug the keypad ribbon cable from J16.
4. Remove the 4 lock nuts (13) from the main board with a 7 mm nut driver.
5. Carefully remove the main board from the enclosure. If the keypad or display need to be replaced, follow the instructions for that component.

Main Board Installation

1. Place the main board over the studs on the enclosure. Make sure the power connector (J) is towards the bottom of the enclosure.
2. Connect the keypad cable.
3. Fasten the main board to the enclosure with 4 lock nuts (13). Be sure not to over tighten.
4. Reinstall the back panel with 2 tamper proof Phillips head screws and 6 Phillips head screws. Be sure not to over tighten.

Keypad Replacement

If the keypad needs to be replaced due to damage or malfunction, follow the steps below to remove the inoperative keypad and replace it with a new one. The main board must be removed to access the keypad.

Model 350 I.S. Keypad Removal

1. Remove the main board. Follow the instructions for *Main Board Removal*.
2. Remove the 4 lock nuts from the keypad studs. Also remove the 2 plastic spacers from the keypad studs.
3. Carefully remove the keypad from the front enclosure.

Model 355 I.S Keypad Removal

1. Remove the main board. Follow the instructions for *Main Board Removal*.
2. There is a steel mounting plate covering the keypad. This must be removed in order to extract the keypad. Remove the 4 lock nuts holding on the plate with a 7 mm nut driver.
3. Carefully remove the mounting plate from the enclosure at set aside. Be sure not to remove the plastic standoffs from the plate.
4. The keypad is fastened to the enclosure by 6 lock nuts. Also there are 4 metal standoffs which provide space for the mounting plate that was removed in the previous step. Remove the 4 standoffs and set them aside.

5. Use a 7 mm nut driver to remove the nuts securing the keypad. The three nuts on the bottom of the keypad are not accessible with a nut driver. Use either a 7 mm wrench, small adjustable wrench or 7mm socket on a small ratchet.
6. Carefully remove the keypad from the front enclosure.

Model 350 I.S. Keypad Installation

1. Place the keypad over the keypad studs on the front enclosure.
2. Use a 7 mm nut driver to fasten the keypad to the front enclosure with 4 lock nuts (8). Also install the 2 plastic spacers (7). Refer to Figure 27 for lock nut and spacer positions. Be sure not to over tighten the lock nuts. 2 lb in maximum.
3. Connect the keypad cable to the main board. Reinstall main board (refer to *Main Board Installation*).
4. Reinstall the back panel with 2 tamper proof Phillips head screws and 6 Phillips head screws. Be sure not to over tighten.

Model 355 I.S. Keypad Installation

1. Place the keypad over the keypad studs on the front enclosure. Make sure the keypad cable connector is facing the left side of the enclosure.
2. Secure the keypad by using a 7 mm nut driver and install one lock nut on the top center keypad stud. Install one lock nut on the left side and another lock nut on the right side. Refer to Figure 28 for positions of lock nuts and spacers.
3. With your fingers install the remaining three lock nuts over the keypad studs on the bottom of the keypad.
4. Use either a 7 mm wrench, small adjustable wrench or 7mm socket on a small ratchet to tighten the three lock nuts. Be sure not to over tighten. 2 lb in maximum.
5. Connect the keypad cable to the main board. Reinstall main board (refer to *Main Board Installation*).
6. Reinstall the back panel with 2 tamper proof Phillips head screws and 6 Phillips head screws. Be sure not to over tighten.

Display Replacement

If the display needs to be replaced due to malfunction, follow the steps below to remove and replace the defective display. The main board must be removed in order to access the display.

Display Removal

1. The display is attached to the back of the main board with 3 plastic standoffs and a 6 pin header. From the component side of the main board, squeeze the plastic standoff with needle nose pliers and push the standoff through the hole on the main board. Be careful not to bend the pins of the 6 pin header.
2. Pull the display from the main board.
3. If the 6 pin header is in the display board, remove it and set aside. If the 6 pin header stayed with the main board, leave it there.
4. Remove the 3 plastic standoffs by squeezing the standoff with needle nose pliers and push it through the hole on the display. Side the standoffs aside.

Display Installation

1. Install 3 plastic standoffs on the new display by pushing them through the holes on the display.
2. Line up the display header with the holes on the back of the main board.
3. Gently push the header into the holes on the main board and also line up the 3 standoffs with the corresponding holes in the main board.
4. Place your thumbs in the middle of the display on either side and your fingers on the component side of the main board. Press the standoffs into the holes of the main board.
5. Reinstall main board (refer to *Main Board Installation*).
6. Reinstall the back panel with 2 tamper proof Phillips head screws and 6 Phillips head screws. Be sure not to over tighten.

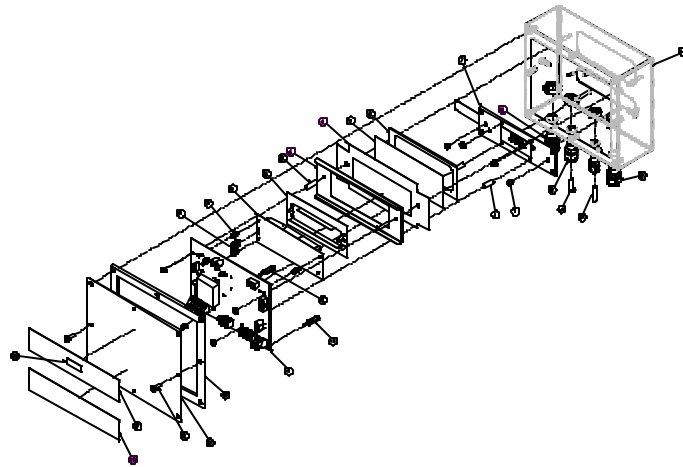

Figure 27: Model 350 I.S. Assembly Drawing

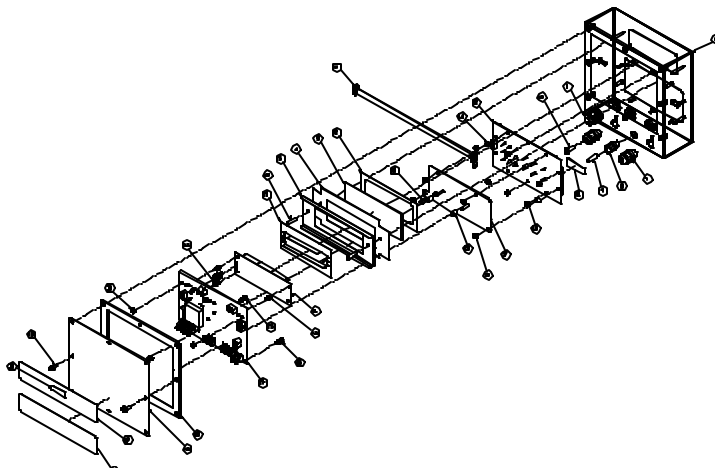

Figure 28: Model 355 I.S. Assembly Drawing

Appendix B: Label Drawings

Reference for Model 350/355 I.S., battery and AC to DC supply labels drawings.

41496 Rev. B: Model 3501 AC to DC Power Supply Label

NOTES:

- 1 MATERIAL - GSE P/N 41-10-35040
LABEL MATERIAL MUST BE CSA APPROVED
- 2 COLORS - BLACK ARTWORK ON SILVER BACKGROUND.
3. LABEL PRINTED ON WEBER LABEL PRINTER USING LABEL FILE 41496.JOB
4. DATE OF MANUFACTURE PRINTED ON LABEL WHEN LABEL IS PRINTED.
5. INDIVIDUAL APPROVAL MARKINGS TO BE ADDED UPON COMPLETION OF EACH APPROVAL

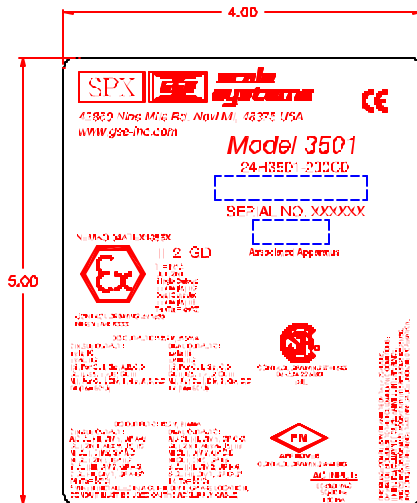

REVISIONS					
REV.	DESCRIPTION	ECN	DATE	BY	APPRV
A	INITIAL RELEASE	-----	1-13-04	RWB	---
B	LABEL SIZE WAS 4"X3", ADDED CSA, EX APPROVALS	8625	6-6-04	RWB	KJP

THIS DRAWING MAY NOT BE MODIFIED WITHOUT AUTHORIZATION FROM FM APPROVALS USE FM FORM #797 FOR NOTIFICATION OF PROPOSED CHANGES

		28-1D-41498	1	2
QTY REQ'D	ITEM NO.	PART NO.	DESCRIPTION/MATERIAL	
BILL OF MATERIAL				
PROPERTY OF SPX GE SCALE SYSTEMS		DRAWN: <u>RWB</u> 1-13-04 CHECKED: <u>RWB</u> 1-13-04 ENGINEER: <u>KJP</u> 1-13-04 APPROVED: <u>KJP</u> 1-13-04 PROJECT NO: <u>D2-22E</u> DO NOT SCALE DRAWING		
UNLESS OTHERWISE SPECIFIED		GSE P/N: <u>41-10-35040</u> PRODUCT LABEL MODEL 3501 AC-DC POWER SUPPLY SERIAL: <u>54879</u> DRAWING NO: <u>41496</u> REV: <u>B</u>		
SURFACE FINISHES PER ASS'Y 428		SCALE: NONE WEIGHT: ----- SHEET: 1 OF 1		

41341 Rev. B: 355 I.S. Generic Rear Label (5 Volt Excitation)

NOTES:

- 1 MATERIAL - GSE P/N 41-10-38016
LABEL MATERIAL MUST BE CSA APPROVED
- 2 COLORS - BLACK ARTWORK ON SILVER BACKGROUND.
- 3 LABEL PRINTED ON WEBER LABEL PRINTER USING LABEL FILE 41341.JOB
- 4 INDIVIDUAL APPROVAL MARKINGS TO BE ADDED UPON COMPLETION OF EACH APPROVAL

REVISIONS					
REV.	DESCRIPTION	ECN	DATE	BY	APPROV
A	INITIAL RELEASE	----	1-13-04	RWB	---
B	REVISION WAS 41-10-3045, NOW 41-10-3080	8823	5-5-04	RWB	KJP

THIS DRAWING MAY NOT BE MODIFIED WITHOUT AUTHORIZATION FROM FM APPROVALS. USE FM FORM #797 FOR NOTIFICATION OF PROPOSED CHANGES

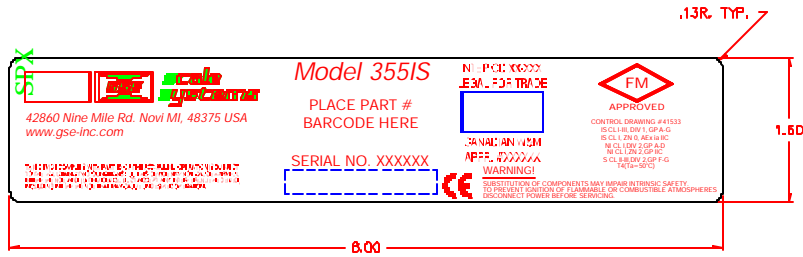

QTY REQ'D	ITEM NO.	PART NO	DESCRIPTION/MATERIAL
		28-10-41341	1 2
BILL OF MATERIAL			
DRAWN: RWB 1-13-04		42860 NINE MILE ROAD NOVI, MI 48375-1122 USA	
CHECKED: RWB 1-13-04		GENERIC REAR LABEL	
DESIGNED: KJP 1-13-04		MODEL 355IS STD INDICATORS	
APPROVED: KJP 1-13-04		REV: 54879	DRAWING NO: 41341
PROJECT NO: D2-228		REV: B	
DO NOT SCALE DRAWING			

PROPERTY OF GSE, USE SOME SYSTEMS
This drawing is intended only for the information and reference use of the recipient. It is not to be used in whole or in part, in any manner or for any purpose, without the prior written consent of GSE.
USE SCALE DIMENSIONS, ADVISE BY EX. COPY.
UNLESS OTHERWISE SPECIFIED
DIMENSIONS ARE IN INCHES
DIMENSIONS ARE UNLESS OTHERWISE SPECIFIED
SURFACE FINISHES PER ANSI Y14.2M
TOLERANCES BY DECIMALS:
.125 - .1250 .3000 = A-G02
.001 - .0010 .0010 = A-D 20P
FILLING: .0010
UNLESS OTHERWISE SPECIFIED BY THE DRAWING

Appendix C: Control Drawings

Reference of system diagrams for connecting the Model 350/355 I.S. to peripherals in the hazardous and safe areas.

Model 350 I.S. and Model 355 I.S. Technical Manual
Version 3.0
Part Number 39-10-41432