

AD-4323

Weighing Indicator

Instruction Manual

v.3.d 91.10.09 TES

AND
A&D WEIGHING
...Clearly a Better Value

1555 McCandless Drive, Milpitas, CA 95035
Tel: (800) 726-3364 / (408) 263-5333 * Fax: (408) 263-0119
Fax-on-Demand: (800) 726-7099, Press 2 * Website: www.andweighing.com
Email: scales@andweighing.com

○ Check Weighing Mode • F-70 = "1"

Control I/O External Interface • Check Mode (F-70 = "1")	Page 64
Setpoint • Check Comparison Mode 1 (F-70 = "1", F-15 = "1") ..	Page 65
Setpoint • Check Comparison Mode 2 (F-70 = "1", F-15 = "2") ..	Page 68
Setpoint • Check Comparison Mode 3 (F-70 = "1", F-15 = "3") ..	Page 71
Setpoint • Check Comparison Mode 4 (F-70 = "1", F-15 = "4") ..	Page 74
Setpoint • Check Comparison Mode 5 (F-70 = "1", F-15 = "5") ..	Page 77
Set Weight Value View Mode	Page 78
Standard Serial Output	Page 80

Options

Parallel BCD Output (Option OP-01)	Page 82
RS-232C Interface (Option OP-04)	Page 84
Setpoint Unit (Option OP-05)	Page 88
Analog Output (Option OP-07)	Page 92
Dimensions	Page 94

COMPLIANCE WITH FCC RULES

Please note that this equipment generates, uses and can radiate radio frequency energy. This equipment has been tested and has been found to comply with the limits of a Class A computing device pursuant to Subpart J of Part 15 of FCC rules. These rules are designed to provide reasonable protection against interference when equipment is operated in a commercial environment. If this unit is operated in a residential area it might cause some interference and under these circumstances the user would be required to take, at his own expense, whatever measures are necessary to eliminate the interference.

(FCC = Federal Communications Commission in the U.S.A.)



AD-4323

CONTENTS

FCC Rules	Page 3
<i>Introduction</i>	
Introduction	Page 6
Features	Page 6
Front Panel Description	Page 7
Rear Panel Description	Page 9
Specifications	Page 10
<i>Installation</i>	
General Rules	Page 16
Load Cell Connection	Page 17
Load Cell and Input Sensitivity.....	Page 17
Quick Install	Page 18
Display Example Resolution Table	Page 21
<i>Calibration</i>	
Items In The Full Calibration Procedure	Page 23
Calibration Flowchart	Page 25
Full Calibration Procedure	Page 26
ZERO CAL & Fine SPAN Adjustment	Page 29
Calibration Errors	Page 31
<i>F-Functions</i>	
About Changing the F-Functions	Page 33
Changing the F-Functions Procedure	Page 34
Errors - Changing the F-Functions.....	Page 35
A Note Concerning Batch vs Check Weighing	Page 36
F-Functions Listed	Page 37
The F-Functions and their Settings	Page 39
<i>I/O Interfacing</i>	
○ <u>Batch Weighing Mode • F-70 = "0"</u>	
Control I/O External Interface • Batch Mode (F-70 = "0")	Page 51
Setpoint External Interface • Batch Mode (F-70 = "0")	Page 52
Timing - Normal Batching (F-70 = "0", F-15 = "1")	Page 54
Timing - Loss-In Weight (F-70 = "0", F-15 = "2")	Page 56
Timing - Normal Batching (F-70 = "0", F-15 = "3")	Page 58
Timing - Loss-In Weight (F-70 = "0", F-15 = "4")	Page 61

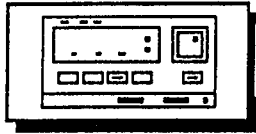

AD-4323 Weighing Indicator

Introduction

THANK YOU FOR YOUR A&D PURCHASE

This is an INSTRUCTION MANUAL for the AD-4323 Weighing Indicator. The AD-4323 is the product of years of design, development, and in-field testing. It is designed to withstand harsh environmental conditions – and each indicator is subjected to several levels of quality control before it leaves the factory. Every care has been taken during the manufacturing process of this indicator to ensure that it will perform accurately and reliably for many years.

INTRODUCTION

The AD-4323 is the choice for dynamic and static weighing applications requiring quality, performance and economy.

Extraordinary speed, accuracy and reliability set the AD-4323 Indicator apart from every other unit in its class. High-speed 70 times per second sampling makes the AD-4323 ideal for dynamic weighing applications. The built-in setpoint connector permits the easy attachment of the optional Setpoint Unit to make the AD-4323 the heart of a simple, but very effective weighing controller system for batch weighing platform setups.

Like every A&D indicator, the AD-4323 is designed for flawless performance in demanding industrial applications. The analog section is completely sealed against RFI interference and A&D's Watchdog™ circuitry automatically resets the unit if a software crash starts to develop for uninterrupted weighing. A sealed front panel keeps out dirt, and the large fluorescent blue display can be easily read in any light. Housed in a rugged case, the AD-4323 is designed for easy panel mounting.

Modern industry demands equipment that is both versatile and easily connectable to other devices. Optional RS-232C and BCD interfaces are available to connect the AD-4323 to computers and printers. A&D offers a number of high-quality printers to satisfy a wide range of hard copy requirements.

FEATURES

- High speed A/D converter - up to 70 times per second.
- Simple calibration via **FDC** (Full Digital Compensation) function.
- WATCHDOG** circuitry virtually eliminates malfunctions commonly associated with computerized equipment.
- Screened against **RFI** (Radio Frequency Interference).
- AD-4323 with option **OP-05** (Setpoint Unit) may be operated anywhere.
- Convenient optional interfaces, parallel **BCD** (Binary-Coded-Decimal) and serial **RS-232C/Current Loop (Passive)**.
- High A/D resolution and high accuracy.

FRONT PANEL DESCRIPTION

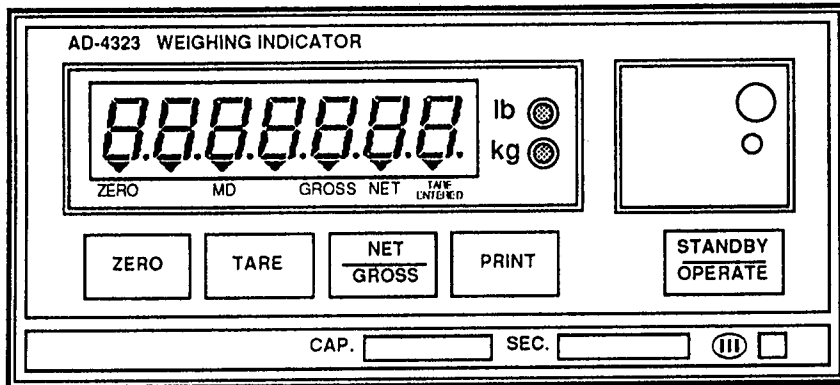

The **STANDBY/OPERATE** Key

This key switches the unit between STANDBY and OPERATE mode. While in STANDBY mode - the display will go OFF and all data output will stop. The power cord must be removed to disconnect power to the AD-4323.



The **ZERO** Key

The **ZERO** key returns the display to the center of ZERO when the weighing device is empty (user selected within $\pm 2\%$ or 10% of the maximum capacity), and motion is not detected (MD annunciator is not on). It should not be confused with the **TARE** key which re-ZERO's the display and switches to NET mode.



The **TARE** Key

The **TARE** key switches to NET mode, ZERO's the display, stores the TARE weight in memory (if motion is not detected) and the TARE ENTERED Annunciator will light.



Maximum TARE value is Max. Capacity, regardless of the decimal point position (if any). Max. Capacity is also the maximum display value which can be stored as TARE when in GROSS mode.



The **NET/GROSS** Key

The **NET/GROSS** key switches between the two modes. The annunciators and display will alternate between NET and GROSS.

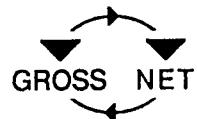

The **PRINT** Key

The **PRINT** key transmits to printer via Option OP-01 (BCD output) or Option OP-04 (RS-232C interface) and Standard Current Loop.

▼
ZERO

The **ZERO** Annunciator triangle will appear when the display is showing the center of ZERO.

▼
MD

The **MD** (Motion Detection) Annunciator triangle will appear when the display is unstable due to weighing device motion.

▼
GROSS

The **GROSS** Annunciator triangle will appear when the display is in the GROSS mode, the display showing the GROSS weight.

▼
NET

The **NET** Annunciator triangle will appear when the display is in the NET mode, the display showing the NET weight.

▼
TARE ENTERED

The **TARE ENTERED** Annunciator triangle will appear when a TARE weight has been entered.

lb 
USA version only

The **lb** Annunciator light will appear when the AD-4323 is in the pound weighing mode - the displayed weight is in pounds. *note: lb/kg version only (USA).*

kg 

The **kg** Annunciator light will appear when the AD-4323 is in the kilogram weighing mode - the displayed weight is in kilograms.

t 
International version only

The **t** Annunciator light will appear when the AD-4323 is in the tonne weighing mode - the displayed weight is in tonne. *note: International version only.*

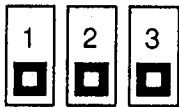

There are three dip-switches behind the front panel (removed by the Front Panel Cover Screw).

- 1) Dip-switch no. 1 moves the AD-4323 into **View Mode** (see p. 76).
- 2) Dip-switch no. 2 moves the AD-4323 into **Calibration Mode**.
- 3) Dip-switch no. 3 moves the AD-4323 into **F-Function Mode**.



CAP. ■ In the space provided, the owner should mark the AD-4323's set weighing (max.) capacity, and minimum division.

SEC. ■ In the space provided, the owner should mark the AD-4323's section weight specification.

To Clear ZERO and TARE Memories



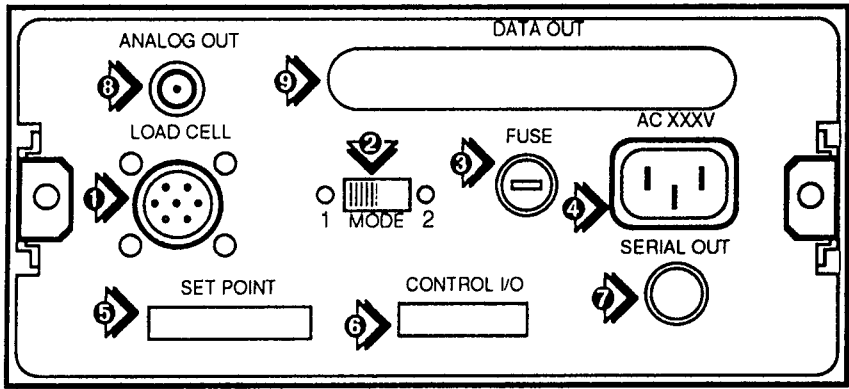

To clear the ZERO and TARE memories: Start with the display OFF. Press and hold the **TARE** key. While holding the **TARE** key, press the **STANDBY/OPERATE** key.

REAR PANEL DESCRIPTION



- ❶ Load Cell connector.
- ❷ lb ↔ kg switch (USA version) or **front panel keys enable** ↔ **front panel key disable** switch (International version).

	Mode	USA	International
1	 <small>1 MODE 2</small>	lb weighing	Disable Front Panel Keys
2	 <small>1 MODE 2</small>	kg weighing	Enable Front Panel Keys

- ❸ **Fuse Holder**
(screw counter-clockwise for removal)

Line Voltage	Fuse
AC 100V ~120V	0.5A
AC 220V ~240V	0.3A

- ❹ Three prong **Power Connector** with ground.
- ❺ **Setpoint Connector.** To connect with Option OP-05 or similar setpoint device.
- ❻ **Control I/O Connector.** To connect with weighing equipment accepting control signals.
- ❼ **Current Loop Serial Outlet Connector** for Printer, external display.
- ❽ Optional OP-07 **Analog Output Connector.** 4→20mA.
- ❾ Optional OP-01 **Parallel Binary-Coded-Decimal BCD Output Connector.** Open-collector output.
- ❿ Optional OP-04 **Serial Interface Connector.** Two types of serial interface are available with this option: 1) EIA-RS-232C. 2) 20mA current loop (passive).

SPECIFICATIONS

■ ANALOG INPUT and A/D CONVERSION

Input Sensitivity	up to 0.6 μ V/D (D="min. division" or "graduation")
ZERO Adjustment Range	0.35mV~24mV
Max. Load Cell Input Volt.	36 mV
Load Cell Excitation	12V DC \pm 5% 280mA
ZERO Temperature Comp.	\pm (0.2 μ V + 0.0008% of Dead Load)/ $^{\circ}$ C TYP
Span Temperature Comp.	\pm 0.0008% / $^{\circ}$ C TYP
Non-Linearity	0.01% F.S.
Input Noise	\pm 0.3 μ V _{p-p}
Input Impedance	10 M Ω
A/D Conversion Method	3 phase, true integrating dual-slope type
A/D Resolution	96,000 Counts Max.
A/D Conversion Rate	approx. 70 times/second (14 m sec/conversion)

■ DIGITAL SECTION

Weighing Display	High intensity 7-segment, cobalt-blue fluorescent
Display Height	13mm (1/2")
Minimum Division	times 1, x2, x5, x10, x20, x50
Maximum Display	"+500450
Under ZERO Indication	"-" minus sign
"ZERO" ▼ Annunciator	Center of ZERO (0 \pm 0.17D)
"MD" ▼ Annunciator	Motion Detection
"GROSS" ▼ Annunciator	GROSS Mode
"NET" ▼ Annunciator	NET Mode
"TARE ENTERED" ▼ Annun.	Tare has been entered
"lb" ● Annunciator	Pounds Displayed (lb or kg version)
"kg" ● Annunciator	Kilograms Displayed
"t" ● Annunciator	Tonne Displayed (kg or t version)
STANDBY / OPERATE KEY	Activates display and functions.
ZERO Key	ZERO's the Display when stable.
TARE Key	Tare when stable - in NET mode, display ZERO.
GROSS / NET Key	Changes from "GROSS" to "NET" and vice versa.
PRINT Key	Send print command to printer via current loop OP-01 or OP-04.

GENERAL

Power Requirements	100,115,220,240V AC +10%,-15% 50/60Hz
NET Weight	Approx. 3kg (6.6lb)
Operating Temperature	-5°C to 40°C (23°F to 104°F)
Maximum Humidity	85% (non-condensing)
Physical Dimensions	192(W)x187(D)x96(H)mm 7.56"x7.36"x3.78"
Memory Battery Back-up	6 years or more without AC power (lithium).

STANDARD ACCESSORIES quantity

Load Cell Connector	1
Serial Outlet Connector	1
Setpoint Connector	1
Control I/O Connector	1
Fuse: 100 or 120 V AC = 0.5A; 220 or 240 V AC = 0.3A	1
Power Cable	1
Capacity Sticker	1
Rubber Feet	4

OPTIONS

Option OP-01	Parallel BCD (Binary-Coded-Decimal) output (DATA OUT). Output data: weight, NET/GROSS, MD Decimal point, lb, kg, (t), print trigger, overload.
Option OP-04	Serial Interface. Two types of serial interface are available with this option: 1) EIA-RS-232C, with or without handshake. 2) 20mA current loop (passive). Baud Rate & Format are identical to RS-232C.
Option OP-05	Setpoint Unit. Independent unit in separate metal casing. The unit can be directly interfaced via an attached cable and connector. Final Weight (Target), Free Fall, Preliminary Weight (cut-off point), and High/Low Limit.
Option OP-07	Analog output (current).

WEIGHT CONVERSION TABLE

One kg	= 2.204 62 lb(avoir) approximately.
One lb	= 0.453 59kg.
One t	= tonne 1,000kg (Metric Ton) or 2,204.62 lb approximately.
	= ton, long: (20 cwt) 2,240 lb or 1,016.05kg approximately.
	= ton, short: 2,000 lb or 907.18kg approximately.
	= tun 216 imp. gal. (ale), 252 imp. gal. (wine). "weight"=volume x density. One imp. gal. of distilled water at 62°F=10 lb=4.536kg but also equals about 4.546 liters/dm ³ /kg at 4°C. One liter of water at 4°C equals 1kg. One US gal. is about 5/6 of an imp. gal. or about 3.785 liters.

F-FUNCTIONS and SETTINGS

F 01	Decimal Point Adjustment	Displays to 1,2,3 or 4 decimal places.
F 02	Weighing Unit Selection	"kg"↔ "t" (Not USA version)
F 03	Display Update Rate	17 times/sec, 4 times/sec.
F 04	Digital Filter	Week ↔ Strong.
F 05	Set ZERO Range	2% or 10% of Maximum Capacity.
F 06	Motion Detection Condition	0.5 sec, 1 count → 1 sec, 9 counts
F 07	Auto. ZERO Track. Comp.	1 sec, .5 division → 2 sec, 4.5 division
F 08	Holding Mode	Normal Hold, Peak Hold
F 09	Comparison Result Output	Normal Output, Locked w/ Display

For Batch Weighing

F 10	Pulse Width of FINISH signal	0.1 sec → 2.0 sec
F 11	ZERO Band	Selectable (enter weight)
F 12	Optional Preliminary Weight	Selectable (enter weight)
F 13	Timer - Comparator Inhibiter	0.1 to 2.0 seconds or Disable.
F 14	Automatic Free Fall Comp.	Set Weight or Disable.
F 15*	Measurement Mode	Normal, Loss-in Batching. *When F-70="0"
F 15*	Comparison Mode	Modes 1→5. *When F-70="1".
F 16	TARE & ZERO keys Availability	Stable or Always Working (Not USA version).
F 17	TARE key Availability	Avail., N. A. at Minus Gross (Not USA version)
F 18	Timer - Finish Signal	Set between 0.1 sec. and 9.9 sec.
F 19	N. A.	N. A.

Front Panel Keys

F 20	Panel Key Disable Selection	Enable/Disable Selection (Not USA version)
-------------	-----------------------------	--

<input type="checkbox"/> For Standard Current Loop		
F 21	Baud Rate	600, 2400 Baud.
F 22	Output Data Gross+Net+Tare	Display, GROSS, NET, Tare or
F 23	Output Mode	Stream, Auto Print, PRINT key.
F 24	Output Availability	Always Available, or Stable Only
F 25 → 30	N. A.	

<input type="checkbox"/> For BCD Option OP-01		
F 31	Output Data	Display, GROSS, NET, or Tare Data.
F 32	Output Mode	Stream, Auto Print, PRINT Key.
F 33	Output Logic	Positive Logic, Negative Logic.
F 34 → 40	N. A.	

<input type="checkbox"/> For Serial Interface Option OP-04		
F 41	Baud Rate	600, 1200, 2400, 4800, 9600.
F 42	Output Data Gross+Net+Tare Data (also update rates).	Display, GROSS, NET, Tare or
F 43	Output Mode	Stream, Auto Print, Print Key, Command.
F 44	Output Availability	Always Available, Only when Stable
F 45 → 50	N. A.	

<input type="checkbox"/> For Analog Option OP-07		
F 51	Analog Output Data	Display, Gross, or Net Data.
F 52	Output current at display ZERO	0.0mA through 99.9mA.
F 53	Output current at Full Scale	0.0mA through 99.9mA.
F 54 → 60	N. A.	

<input type="checkbox"/> For Check Weighing		
F 61	High High Limit Weight	Input the Weight.
F 62	High Limit Weight	Input the Weight.
F 63	Low Limit Weight	Input the Weight.
F 64	Low Low Limit Weight	Input the Weight.
F 65 → 69	N. A.	

<input type="checkbox"/> Weighing Mode		
F 70	Weighing Mode	Batch Weighing, Check Weighing

This page blank

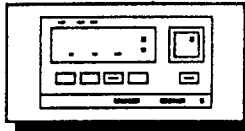

AD-4323 Weighing Indicator

Installation

GENERAL RULES

- ❑ Don't install the AD-4323 in direct sunshine. Avoid sudden temperature changes, vibration, wind, water, or excessive dirt.
- ❑ Best temperature is about 20°C/68°F at about 50% Relative Humidity.
- ❑ Earth the AD-4323 via the power cable to the rear terminal. Ensure a good earth connection. Do not earth directly to other equipment.
- ❑ Analogue input/output signals are sensitive to electrical noise. Do not bind these cables together as it could result in cross-talk interference. Please also keep them well away from AC power cables. Keep all cable/coax as short as possible.
- ❑ If the local AC electricity supply fluctuates by more than $\pm 10\%$ an AC regulator must be used to stabilize the power supply.

LOAD CELL CONNECTION

Attention



- ❑ Use a six wire cable with shield. If the AD-4323 is located near the Load Cells (within a few yards or meters) you may use a 4 wire cable with shield, but first connect pins 1 & 2 and 3 & 4 with independent jumper leads.
- ❑ The analogue output from the Load Cell and the RS-232C input/output signals are sensitive to electrical noise. Do not bind these cables together as it could result in cross-talk interference. Please also keep them well away from AC power cables.

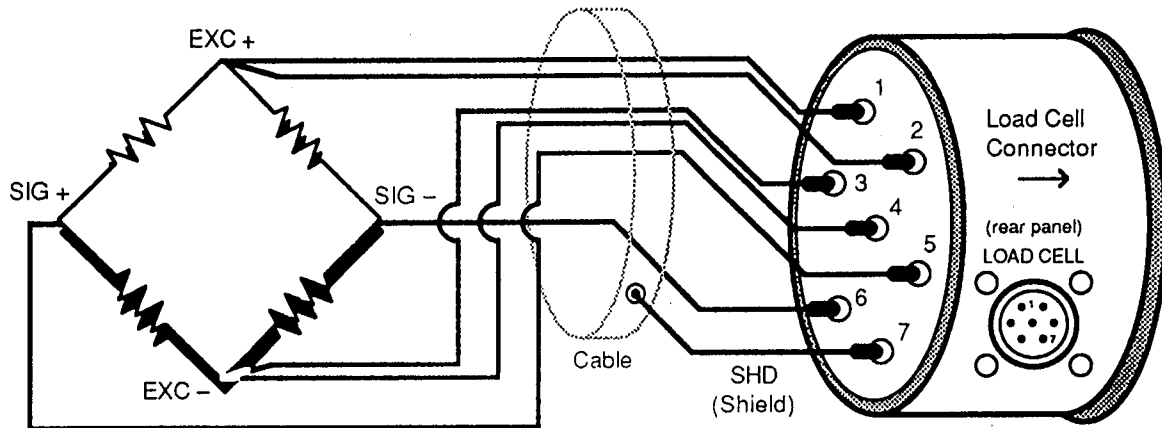

Load Cell Connections					
Pin	Signal		Pin	Signal	
1	Positive Excitation Voltage	(EXC+)	5	Positive Signal Voltage	(SIG+)
2	Positive Sense Voltage	(SEN+)	6	Negative Signal Voltage	(SIG-)
3	Negative Sense Voltage	(SEN-)	7	Shield	(SHD)
4	Negative Excitation Voltage	(EXC-)			

LOAD CELL AND INPUT SENSITIVITY

The relationship between Load Cell and Input Sensitivity (*X*) for the AD-4323 is as follows:

- ❑ **Example:**

Load Cell Capacity	100kg	"A"
Rated Output	3mV/V	"B"
Max. Capacity of Platform	50kg	"C"
Min. Division of Display	0.01kg	"d"
Excitation	12V	"EXC"
- ❑ Actual Load Cell Range Used ("*a*"%) is: $(50\text{kg}/100\text{kg}) \times 100 = 50\%$
- ❑ When a single Load Cell without a lever is used, the following formula should apply: $"X" = ("a"/100) * "EXC" * "B" * 1,000 * ("d"/"C") \mu\text{V}$
- ❑ System design will be satisfactory if "*X*" is between 0.6 μV and 36 μV . In the example above "*X*" = 3.6 μV .

QUICK INSTALL

This section is for those users who wish to simply get the AD-4323 up and working for simple use or testing. If you are going to be using the AD-4323 in a more complicated system, or unusual environment, you may want to study the CALIBRATION section before installation or testing. If you are unfamiliar with any of the terms below, you will find explanations in the ITEMS IN THE FULL CALIBRATION PROCEDURE section, page 21, CALIBRATION section.

If you wish to change one of the sections below, please use the instructions in the ITEMS IN THE FULL CALIBRATION PROCEDURE and THE FULL CALIBRATION PROCEDURE in the CALIBRATION section. This section is just intended for the initial installation.

■ Unpack the AD-4323:

Remove the AD-4323 unit from its packaging - please check that all items on the packing list are included before discarding packaging.

■ Connect to Load Cell(s):

Connect the AD-4323 to the Weighing Device Load Cell(s) via the back panel Load Cell connector. See the LOAD CELL CONNECTION section on the previous page.

■ Connect to Power:

Connect the AD-4323 to power, making sure that the unit is grounded correctly.

■ Set Minimum Division:

For reference, please see page 21

Step 1.  Have nothing on the weighing surface - Press the **STANDBY/OPERATE** key to turn the display ON.

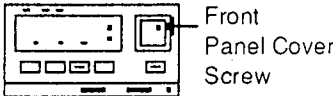
Step 2.  Open the panel cover on the front of the AD-4323 unit by unscrewing the knob - to expose the dip-switches.

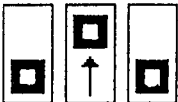
Step 3.  Slide the middle dip-switch (calibration) ON↑.

DISPLAY  "CAL " will be appear for a couple of seconds, followed by:

 "d 01" with the last digit flashing. This is the *internal Minimum Division* that is presently entered into the AD-4323

Step 4. Use the **NET/GROSS** key to move through the available divisions - stop at the internal Minimum Division you want: 1, 2, 5, 10, 20, or 50 - see DISPLAY TABLE p.19.

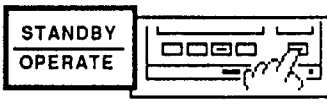

Step 5. 

When you have selected the desired Minimum Division, press the **STANDBY/OPERATE** key.

■ Set Maximum Capacity:

For reference, please see page 21.

DISPLAY

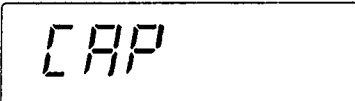

"CAP " will be appear for a couple of seconds, followed by:

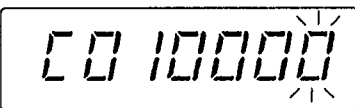

"C010000" with the last digit flashing. This is the *Maximum Capacity* weight (10,000 lb, kg, or t) that is presently entered into the AD-4323

Step 6.

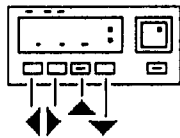

Enter the Maximum Capacity of your weighing device by using the keys as shown.

Step 7.



When you have entered the new Maximum Capacity, press the **STANDBY/OPERATE** key.

■ Perform ZERO Calibration:

For reference, please see page 21.

DISPLAY

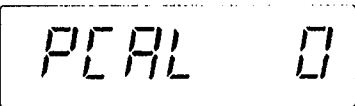

"PCAL 0" will be displayed.

Step 8.



Press the **STANDBY/OPERATE** key for ZERO Calibration.

■ Perform SPAN Calibration:

For reference, please see page 22.

DISPLAY

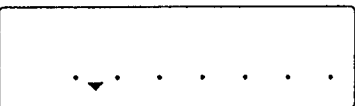

"....." will be appear for a couple of seconds, followed by:

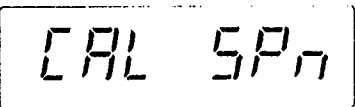

"CAL SPn" (SPAN Calibration) will be appear for a couple of seconds, followed by:

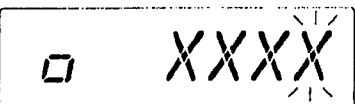

"XXXX" here denotes the Maximum Capacity entered in memory for SPAN.

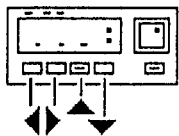
Step 9.  If you are not using Max. Capacity as your SPAN weight - or the exact weight of the Cal. Mass is known - enter in the weight of the calibration mass by using the keys as shown at this time.

Step 10. Place the calibration mass on the weighing device.

Step 11.  Press the **STANDBY/OPERATE** key.

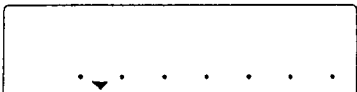
DISPLAY  "." will be appear for a couple of seconds, followed by:

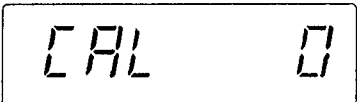
 "CAL 0" will be displayed.

Step 12. Remove the calibration mass from the weighing device.

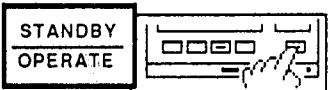
Step 13.  Press the **STANDBY/OPERATE** key.

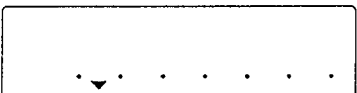
DISPLAY  "." will be appear for a couple of seconds, followed by:

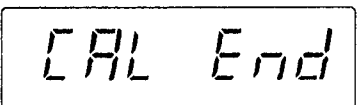
DISPLAY  "CAL End" will be displayed.

Step 14.  Slide the middle dip-switch (calibration) OFF↓.

Step 15. Replace the panel cover on the front of the AD-4323 unit.

■ Setting the Decimal Place:

To set the decimal place - please follow the example given in the CHANGING THE F-FUNCTIONS procedure (page 32) in the REFERENCE section. The example is how to set the decimal place.

■ Problems:

If you have any problems such as error messages, please see: CALIBRATION ERRORS (page 29); ITEMS IN THE FULL CALIBRATION PROCEDURE (page 21); and THE FULL CALIBRATION PROCEDURE (page 24) in the REFERENCE section. Other than that, please study the REFERENCE section, and possibly THE F-FUNCTIONS AND THEIR SETTINGS section for specific problems.

DISPLAY EXAMPLE RESOLUTION TABLE

Maximum Capacity	RESOLUTION					
	1 Min. Div.	2 Min. Div.	5 Min. Div.	10 Min. Div.	20 Min. Div.	50 Min. Div.
300	1/300					
400	1/400					
500	1/500					
600	1/600	1/300				
800	1/800	1/400				
1,000	1/1,000	1/500				
1,200	1/1,200	1/600				
1,500	1/1,500	1/750	1/300			
2,000	1/2,000	1/1,000	1/400			
2,500	1/2,500	1/1,250	1/500			
3,000	1/3,000	1/1,500	1/600	1/300		
4,000	1/4,000	1/2,000	1/800	1/400		
5,000	1/5,000	1/2,500	1/1,000	1/500		
6,000	1/6,000	1/3,000	1/1,200	1/600	1/300	
8,000	1/8,000	1/4,000	1/1,600	1/800	1/400	
10,000	1/10,000	1/5,000	1/2,000	1/1,000	1/500	
12,000		1/6,000	1/2,400	1/1,200	1/600	
15,000		1/7,500	1/3,000	1/1,500	1/750	1/300
20,000		1/10,000	1/4,000	1/2,000	1/1,000	1/400
25,000			1/5,000	1/2,500	1/1,250	1/500
30,000			1/6,000	1/3,000	1/1,500	1/600
40,000			1/8,000	1/4,000	1/2,000	1/800
50,000			1/10,000	1/5,000	1/2,500	1/1,000
60,000				1/6,000	1/3,000	1/1,200
80,000				1/8,000	1/4,000	1/1,600
100,000				1/10,000	1/5,000	1/2,000
120,000					1/6,000	1/2,400
150,000					1/7,500	1/3,000
200,000					1/10,000	1/4,000
250,000						1/5,000
300,000						1/6,000
400,000						1/8,000
500,000						1/10,000

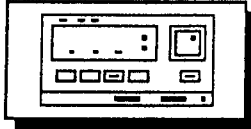

AD-4323 Weighing Indicator

Calibration

ITEMS IN THE FULL CALIBRATION PROCEDURE

The section *FULL CALIBRATION PROCEDURE* on the following pages contains the procedure to input the following information needed to make the AD-4323 function as a Weighing Indicator. Below are some explanations for the major items and shortcuts for individual changes.

Minimum Division

The Display Resolution depends on, and is limited by, the Minimum Division. Display Resolution is Minimum Division divided by the Maximum Capacity (see the DISPLAY RESOLUTION TABLE, page 19). The Minimum Division's are the blocks in which the display will be able to show change in weight. If you set the AD-4323 for 1 internal minimum division, then the display will be able to move by one, ex: 101,102,103.... If you set it for 2 minimum divisions, then the smallest the display will be able to move is by two's, ex: 100,102,104.... And so forth. You are limited to 1,2,5,10,20, or 50 internal divisions - this is in turn limited by the Max. Capacity of your weighing device. The internal divisions are different in the various weighing modes.

Zero Calibration

The ZERO Calibration is simply: recalibrating the AD-4323, to the weighing device, when it has no weight acting on it ("0"). This gives the AD-4323 a base reference point, "zero", to compare with when weight is added. It is possible that temperature changes, wear-and-tear of the Weighing Device, and other influences, may cause the "zero" point to drift - needing recalibration. You may want to do ZERO Calibration on a regular schedule, as weighing conditions demand.

Maximum Capacity

The Maximum Capacity is the full weight that you want your weighing device to handle. This could be the rated capacity of the Load Cells, or some other limit you wish to set. Maximum Capacity also has a relationship to the Display Resolution. Resolution is Minimum Division divided by the Maximum Capacity. Please see the DISPLAY RESOLUTION Table in the INSTALLATION section, page 19.

Span Calibration

SPAN Calibration is simply: recalibrating the AD-4323, to the weighing device, at full capacity. With ZERO Calibration, you set an empty Weighing Device as your "zero" point. With SPAN Calibration, you set the end point of your Weighing Device's ability to weigh - its Max. Capacity. This gives the AD-4323 two extreme points where it knows the correct weight. Now it will accurately calculate what the weights are in between. While the most accurate SPAN Calibration is with Max. Capacity as your SPAN weight - this may not always be possible. In those cases, use the weight closest to Max. Capacity as practical. •The closer to Max. Capacity the SPAN weight is - the more highly accurate the reading is (especially at the higher end).

If you want to perform:

ZERO Calibration ONLY:

If you only want to perform the simple calibration procedure - use the ZERO CAL & FINE SPAN ADJUSTMENT procedure (page 27), after Step 4-B, slide OFF↓ the CAL switch.

To Change Minimum Division ONLY:

If you only want to change the Minimum Division - use THE FULL CALIBRATION PROCEDURE (page 24), after Step 4-B, press the **STANDBY/OPERATE** key, and slide OFF↓ the CAL switch.

To Change Maximum Capacity ONLY:

If you only want to change the Maximum Capacity - use THE FULL CALIBRATION PROCEDURE (page 24), after Step 6-B, press the **STANDBY/OPERATE** key, and slide OFF↓ the CAL switch.

To Perform SPAN Calibration ONLY:

If you only want to do SPAN Calibration - use the ZERO CAL & FINE SPAN ADJUSTMENT procedure, page 27.

Any Mix of Changes:

If you only want to make some other mix of changes or calibrations, please just go through the procedure from the beginning and make your choices as you move through the procedure.

CALIBRATION FLOWCHART

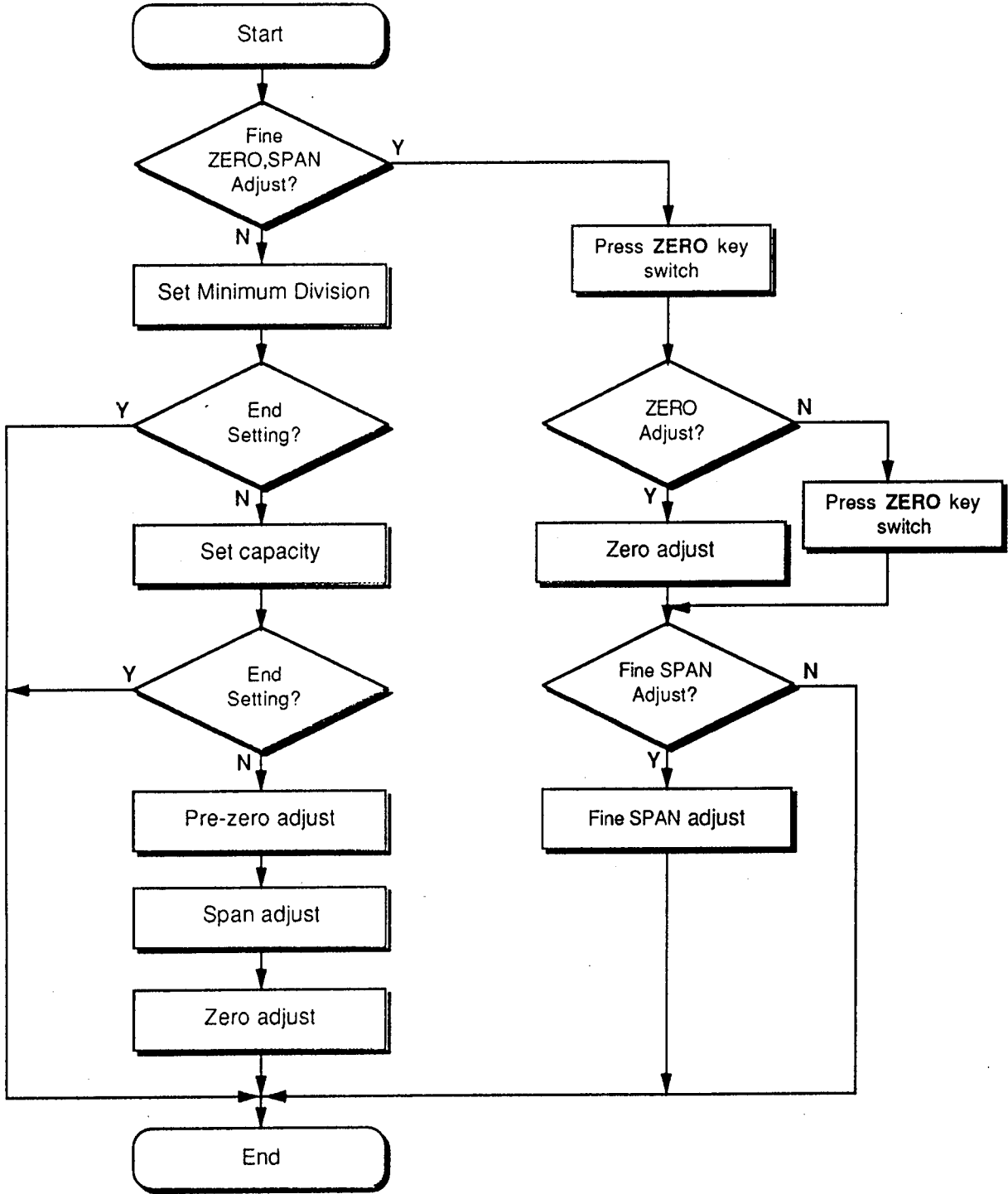

FULL CALIBRATION PROCEDURE

* Calibration and Changing Division or Capacity *
 • Mainly meant for initial installation, or ideal situations •

Please Note



- Your AD-4323 should be calibrated when:
 - first installed, or if any part of the weighing system is changed.
 - if any drift is noted.

Attention



- The AD-4323 must be warmed up (plugged in) for at least 30 minutes before starting calibration.
- During calibration, the weighing system must be kept stable for accurate adjustment.

Note:

The display examples shown in this procedure are initial ones. After this procedure has been done once, the example numbers may be different than the actual numbers displayed.

Step 1.



Press the **STANDBY/OPERATE** key to turn the display ON, and have nothing on the weighing surface.

Step 2.

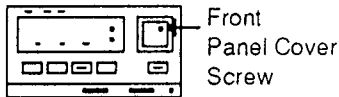

Open the panel cover on the front of the AD-4323 unit by unscrewing the knob - to expose the dip-switches.

Step 3.

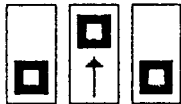

Slide the middle dip-switch (calibration) ON↑.

DISPLAY

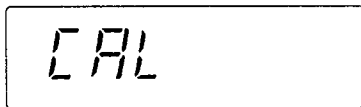

"CAL " will be appear for a couple of seconds, followed by:

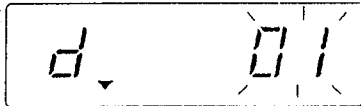

"d 01" with the last digit flashing. This is the *internal Minimum Division* that is presently entered into the AD-4323. You have the following choices.

Step 4.

- A) If you do not want to change the Min. Division., go to Step 5.
- B) If you wish to change the Minimum Division, use the **NET/GROSS** key to move through the available divisions.



Minimum Division

- You are limited to one of the following internal Minimum Divisions: 1, 2, 5, 10, 20, or 50 - see DISPLAY RESOLUTION TABLE, page 19.

Step 5.



A) If there is no change, or B) When you have changed to the new setting, press the **STANDBY/OPERATE** key.

Note:

If you only wanted to change the Min. Div., go to Step 14 and finish.

DISPLAY

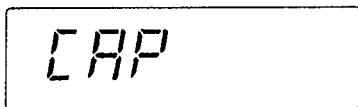

"CAP " will be appear for a couple of seconds, followed by:

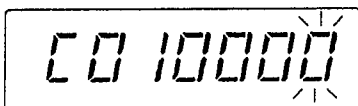

Maximum Capacity



"C010000" with the last digit flashing. This is the *Maximum Capacity* weight (10,000 lb, kg, or t) that is presently entered into the AD-4323

Step 6.

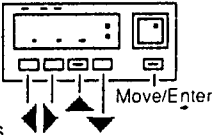
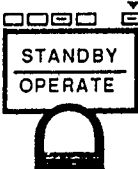
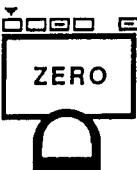
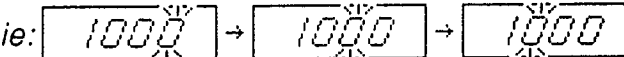
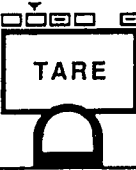
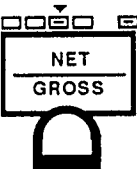
- A) If you do not want to change the Max. Capacity., go to Step 7.
- B) If you wish to change the Maximum Capacity, you may do so now by using the keys as described above in the CALIBRATION KEY ENTERING FUNCTIONS table below. Enter in the Maximum Capacity of your weighing device.

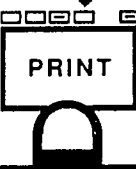
<p>CALIBRATION Key Entering Functions Changing the Display digits</p> 	 <ul style="list-style-type: none"> • The STANDBY/OPERATE key enters settings into memory and moves to the next function.
 <ul style="list-style-type: none"> • The ZERO key moves the flashing cursor left by one place. ie:  	 <ul style="list-style-type: none"> • The TARE key moves it right.
 <ul style="list-style-type: none"> • The NET/GROSS key increases the flashing cursor by one digit. ie:  	 <ul style="list-style-type: none"> • The PRINT key decreases by one digit.

Step 7.



A) If there is no change, or B) When you have changed to the new setting, press the **STANDBY/OPERATE** key.

Note:

If you have changed what you wanted, go to Step 14 and finish.

DISPLAY

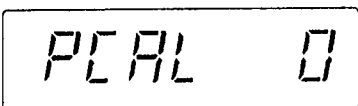

"PCAL 0" will be displayed.

Step 8.



Press the **STANDBY/OPERATE** key.

DISPLAY

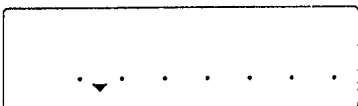

"." will be appear for a couple of seconds, followed by:

Span Calibration

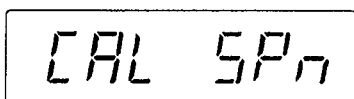

"CAL SPn" (SPAN Calibration) will be appear for a couple of seconds, followed by:

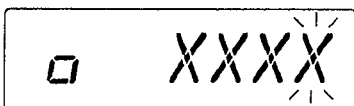

"XXXX" here denotes the Maximum Capacity entered in memory.

Step 9. If you are not using Max. Capacity as your SPAN weight, or the exact weight of the Cal. Mass is known - please enter in the weight of the calibration mass by using the keys as described in the AD-4323 KEY ENTERING FUNCTIONS table above.

Step 10. Place the calibration mass on the weighing device.

Step 11.



Press the **STANDBY/OPERATE** key.

DISPLAY



"." will be appear for a couple of seconds, followed by:

Zero Calibration

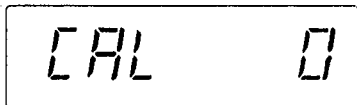

"CAL 0" will be displayed.

Step 12. Remove the calibration mass from the weighing device.

Step 13.



Press the **STANDBY/OPERATE** key.

DISPLAY

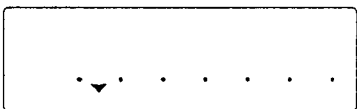

"." will be appear for a couple of seconds, followed by:

DISPLAY

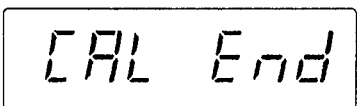

"CAL End" will be displayed.

Step 14.



Slide the middle dip-switch (calibration) OFF↓.

Step 15. Replace the panel cover on the front of the AD-4323 unit.

END End of SPAN CALIBRATION procedure.

ZERO CAL & FINE SPAN ADJUSTMENT

Step 1.

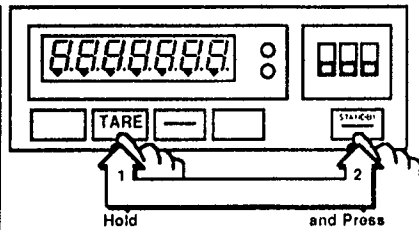

First clear the TARE and ZERO. •Press and hold the TARE key, then press the STANDBY/OPERATE key.

TARE and ZERO will be cleared while the display comes ON

Step 2.

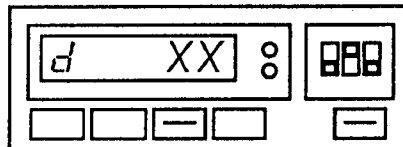
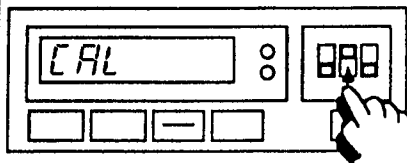

•Slide the middle dip-switch (calibration) ON↑.

"CAL" will be displayed for a couple of seconds, then "d XX" will be displayed. "XX" signifying minimum division in memory.

Step 3.

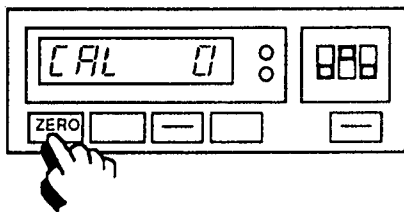

•Press the ZERO key.

"CAL 0" will be displayed.

Step 4.

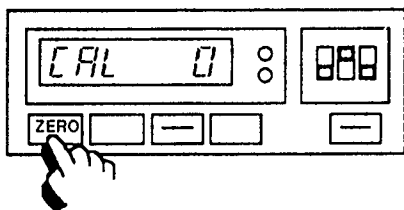

OR

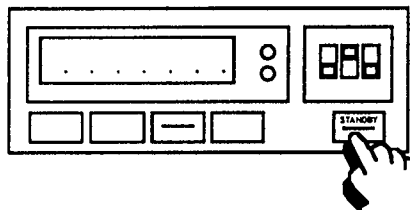

•A) If you don't want to adjust Zero, then press the ZERO key and go to Step. 5.

•B) If you want to adjust ZERO, then remove all weight and press the STANDBY/ OPERATE key.

"....." will be displayed for 10 sec. ZERO CAL has occurred.

Step 5.

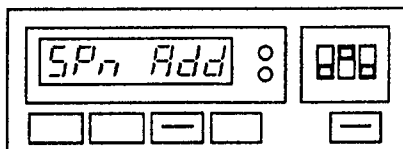

then

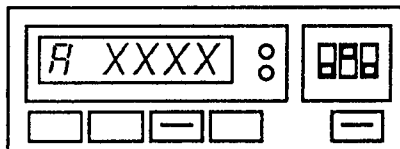

"SPn Add" will be displayed for a couple of seconds.

"A XXXX" will be displayed if there is a mass, or the weight of the system itself, acting on the load cells. It is not necessarily accurate.

Step 6.

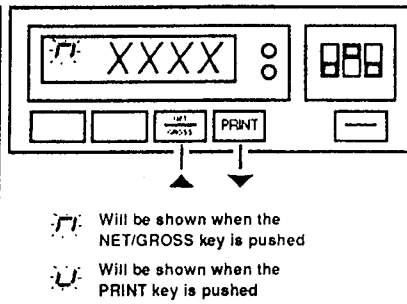

•Load the standard weight you are using on the weighing device. The display will show its weight.

•To adjust, push either the **NET/GROSS** key to increase the display by one, or the **PRINT** key to decrease the display by one. About 3 seconds per 1 count.

Step 7.

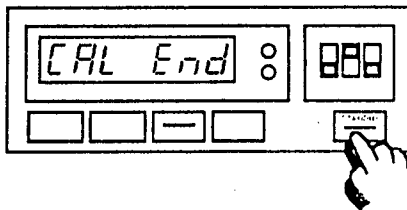

When you are finished the fine adjustment, •Press the **STANDBY/OPERATE** key.

"CAL End" will be displayed.

Step 8.

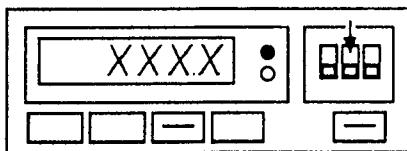

•Slide the middle dip-switch (calibration) OFF↓.

The display will return to normal.

Calibration Errors

DISPLAY



"CErr 1" will be displayed if the resolution exceeds 10,000 Divisions.

DISPLAY

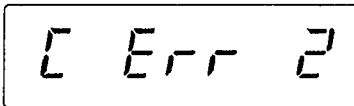

"CErr 2" will be displayed if Load Cell output is too large at ZERO Calibration.

In this case add an additional resistor between EXC+ and SIG-.

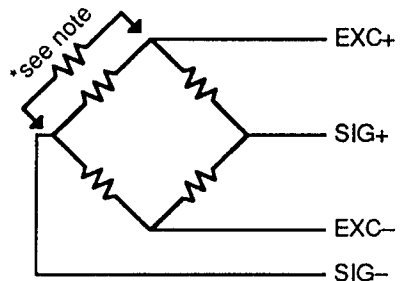

DISPLAY

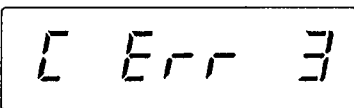

"CErr 3" is displayed if Load Cell output is too small (neg. offset) at ZERO Calibration.

In this case add an additional resistor between EXC+ and SIG+.

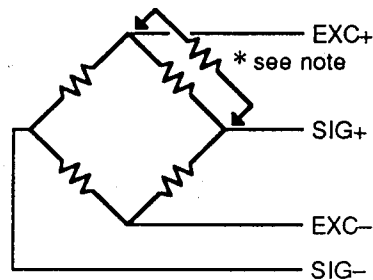

**Note:*

The resistor should have as a high resistance as possible (50kΩ to 500kΩ) and should be of the highest quality, having the lowest temperature coefficient.

DISPLAY

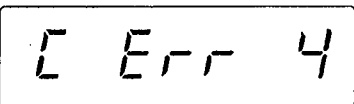

"CErr 4" will be displayed a Calibration Mass over Max. Capacity has been mistakenly entered.

DISPLAY

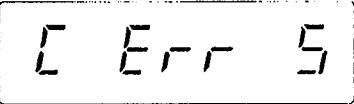

"CErr 5" will be displayed if the Calibration Mass has mistakenly entered as "0", or if it's smaller than the Min. Division.

DISPLAY

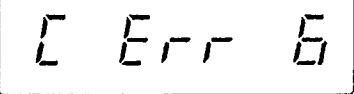

"CErr 6" will be displayed if the Load Cell output is too low.

DISPLAY

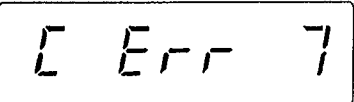

"CErr 7" will be displayed if the Load Cell signal pins are reversed, or incorrectly wired.

DISPLAY



"CErr 8" will be displayed if the Load Cell output is too high.

DISPLAY

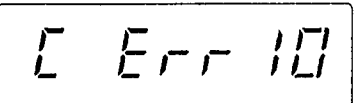

"CErr 10" will be displayed if the Dip Switch 1 is slid ON while in Calibration Mode (CAL. Dip Switch ON).

DISPLAY

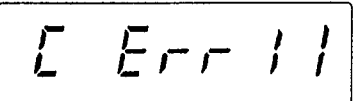

"CErr 11" will be displayed if the ZERO or TARE was not cleared during Fine SPAN Adjustment.

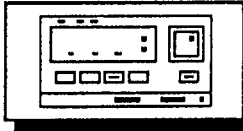



AD-4323 Weighing Indicator





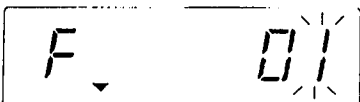

F-Functions

ABOUT CHANGING THE "F" - FUNCTIONS

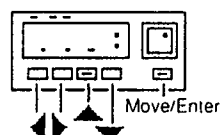
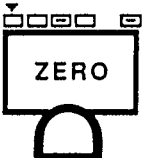
There are a number of AD-4323 functions that are selectable by the user - these functions control many of the important capabilities of the AD-4323. Please take a moment to look through the different F-Functions on the following pages. You are able to change any listed F-Function that you wish. This is accomplished by moving through two levels:

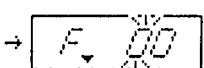
DISPLAY	 <p style="text-align: center;">• F-Function Level •</p>	<p>1) The first level displays an "F" at the far left - the number on the right shows you which F-Function you are presently in. In this example you are in function "F 01", Decimal Point Adjustment. Use the STANDBY/OPERATE key to move to the next level, the settings for "F 01".</p>
DISPLAY	 <p style="text-align: center;">• F-Func. Settings Level •</p>	<p>2) The second level has just a flashing number at the far right, telling you what the setting is for the "F 01". In this example the setting is "3", meaning the decimal point is set three places in. The STANDBY/OPERATE key is now used to move to the next F-Function.</p>

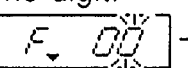
In the CHANGING THE F-FUNCTIONS procedure, the keys are used in the following manner to change the display. Please take a moment to study the key entering functions:

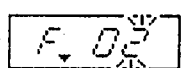
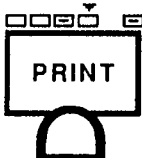
<p>F-FUNCTION Key Entering Functions</p> <p>Changing the Display digits</p> 	<ul style="list-style-type: none"> • The STANDBY/OPERATE key moves to the setting level or, enters and moves to the next F-Function.
 <ul style="list-style-type: none"> • The ZERO key moves the flashing cursor left by one place. <p style="text-align: center;">ie:  → </p>	 <ul style="list-style-type: none"> • The TARE key moves it right.
 <ul style="list-style-type: none"> • The NET/GROSS key increases the flashing cursor by one digit. <p style="text-align: center;">ie:  →  → </p>	 <ul style="list-style-type: none"> • The PRINT key decreases by one digit.

CHANGING THE "F" - FUNCTIONS PROCEDURE

Step 1.  Front Panel Cover Screw

Open the panel cover on the front of the AD-4323 unit by unscrewing the knob - to expose the dip-switches.

Step 2. 

Slide the right dip-switch (F-Function) ON↑.

DISPLAY 

"F 00" will be displayed with the last digit flashing.

Step 3.  NET GROSS

Press the **NET/GROSS** key to move to the first F-Function.

DISPLAY 

"F 01" will be displayed.

Step 4.  STANDBY OPERATE

Press the **STANDBY/OPERATE** key to move into the next level, that of the settings for the F-Function.

DISPLAY 

" 3" (or other number) will be displayed - this is the setting for the F-Function "F 01" presently in memory.

Step 5. You are now in "F 01", Decimal Point Adjustment. If you wanted to change the placement of the decimal point in the display, you would choose a new setting and enter it now.

Decimal Point Adjustment			
F 01	0	No decimal point	12345
	1	10^1	1234.5
	2	10^2	123.45
	3	10^3	12.345
	4	10^4	1.2345

So, if you wanted to change the setting in "F 01", then you would use the **NET/GROSS** key to increase the display by one, or the **PRINT** key to decrease the display by one.

Step 6.  STANDBY OPERATE

If there is no change, or when you have changed to a new setting, press the **STANDBY/OPERATE** key to move forward to the next F-Function level.

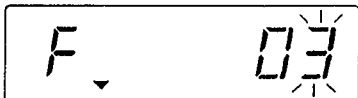
DISPLAY  "F 03" (USA version), Display Update Rate, will be displayed.

Step 7. You are now able to move through and change the F-Functions and their settings as demonstrated above. If there is no change in a function, or you simply wish to move directly to a new one: 1) Move incrementally by pressing the **STANDBY/OPERATE** key twice, or 2) Use the keys to select it at the F-Function level.

Step 8.  When you are finished, slide the right dip-switch (F-Function) OFF↓.

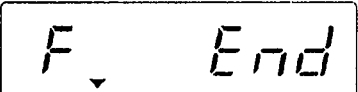
DISPLAY  "F End" will be appear for a couple of seconds.

Step 9. Replace the panel cover on the front of the AD-4323 unit.

Step 10. Return to normal weighing.

END End of CHANGING THE F-FUNCTIONS procedure.

Errors - Changing the F-Functions

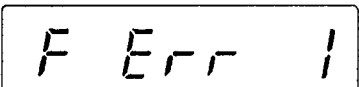
DISPLAY  "F Err 1" will be displayed if there is no such F-function number as the one you set.

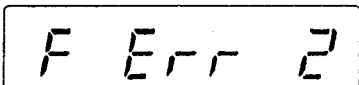
DISPLAY  "F Err 2" will be displayed if there is no such function setting as the one you set.

A NOTE CONCERNING BATCH vs CHECK WEIGHING



If you are using the AD-4323 indicator for static weighing, or not using the SETPOINT interface connector on the back panel, you may disregard this page and F-Functions: F-10 through F-18, F-61 through F-64, and F-70

Besides static weighing, the AD-4323 is pre-programmed for two kinds of weighing modes: batch weighing mode (F-70 = "0"), and check weighing mode (F-70 = "1"). Because of these differences, there are various settings for either system that need to be entered.

Please note that throughout the manual, a note is added when an item is using batch, or check weighing. Example →

Used when F-70 is set at "0"
BATCH WEIGHING MODE

□ F-70 set at "0" is for Batch Weighing.

- Setpoints are entered either through F-Functions F-11, F-12; or through a Setpoint Unit (ex: OP-05); or computer interface.
- When the AD-4323 is in batching mode, F-61, F-62, F-63, and F-64 will not appear as you move through the F-Functions, or operate. They are for check weighing mode.

□ F-70 set at "1" is for Check Weighing.

- Setpoints are entered either through F-Functions F-11, F-61, F-62, F-63, and F-64; or through an external digital switch unit; or computer interface.
- When the AD-4323 is in check mode, F-10, F-12, F-13, F-14, and F-18 will not appear as you move through the F-Functions, or operate. They are for batch weighing mode.

F-FUNCTIONS LISTED

General

F 01	Decimal Point Adjustment	Displays to 1,2,3 or 4 decimal places.
F 02	Weighing Unit Selection	"kg"↔"l" (Not USA version)
F 03	Display Update Rate	17 times/sec, 4 times/sec.
F 04	Digital Filter	Weak ↔ Strong.
F 05	Set ZERO Range	2% or 10% of Maximum Capacity.
F 06	Motion Detection Condition	0.5 sec, 1 count → 1 sec, 9 counts
F 07	Auto. ZERO Track. Comp.	1 sec, .5 division → 2 sec, 4.5 division
F 08	Holding Mode	Normal Hold, Peak Hold
F 09	Comparison Result Output	Normal Output, Locked w/ Display

For Batch Weighing

F 10	Pulse Width of FINISH signal	0.1 sec → 2.0 sec
F 11	ZERO Band	Selectable (enter weight)
F 12	Optional Preliminary Weight	Selectable (enter weight)
F 13	Timer - Comparator Inhibiter	0.1 to 2.0 seconds or Disable.
F 14	Automatic Free Fall Comp.	Set Weight or Disable.
F 15*	Measurement Mode	Normal, Loss-in Batching. *When F-70="0"
F 15*	Comparison Mode	Modes 1→5. *When F-70="1".
F 16	TARE & ZERO keys Availability	Stable or Always Working (Not USA version).
F 17	TARE key Availability	Avail., N. A. at Minus Gross (Not USA version)
F 18	Timer - Finish Signal	Set between 0.1 sec. and 9.9 sec.
F 19	N. A.	N. A.

F 20	Panel Key Disable Selection	Enable/Disable Selection (Not USA version)
------	-----------------------------	--

For Standard Current Loop

F 21	Baud Rate	600, 2400 Baud.
F 22	Output Data	Display, GROSS, NET, Tare or Gross+Net+Tare
F 23	Output Mode	Stream, Auto Print, PRINT key.
F 24	Output Availability	Always Available, or Stable Only
F 25→30	N. A.	

For BCD Option OP-01

F 31	Output Data	Display, GROSS, NET, or Tare Data.
F 32	Output Mode	Stream, Auto Print, PRINT Key.
F 33	Output Logic	Positive Logic, Negative Logic.

For Serial Interface Option OP-04

F 41	Baud Rate	600, 1200, 2400, 4800, 9600.
F 42	Output Data	Display, GROSS, NET, Tare or Gross+Net+Tare Data (also update rates).
F 43	Output Mode	Stream, Auto Print, Print Key, Command.
F 44	Output Availability	Always Available, Only when Stable
F 45→50	N. A.	

For Analog Option OP-07

F 51	Analog Output Data	Display, Gross, or Net Data.
F 52	Output current at display ZERO	0.0mA through 99.9mA.
F 53	Output current at Full Scale	0.0mA through 99.9mA.
F 54→60	N. A.	

For Check Weighing

F 61	High High Limit Weight	Input the Weight.
F 62	High Limit Weight	Input the Weight.
F 63	Low Limit Weight	Input the Weight.
F 64	Low Low Limit Weight	Input the Weight.
F 65→69	N. A.	

Weighing Mode

F 70	Weighing Mode	Batch Weighing, Check Weighing
------	---------------	--------------------------------

THE F-FUNCTIONS AND THEIR SETTINGS

● Indicates Initial Factory Setting

Decimal Point Adjustment			
F 01	● 0	No decimal point	12345
	1	10^1	1234.5
	2	10^2	123.45
	3	10^3	12.345
	4	10^4	1.2345

Weighing Unit Change			International Version ONLY NOT USA VERSION
F 02	● 1	kg	kilogram
	2	t	tonne
<p>Please note that the decimal point will have to be moved if you switch between "kg" and "t". Example: 1001kg will change to 1001t - however, it is <u>1.001</u>t ! The decimal point must be changed.</p>			

Display Update Rate		
F 03	● 1	17 times per second
	2	4 times per second

Digital Filter			
F 04	1	Weakest	<div style="display: flex; justify-content: space-around; align-items: center;"> <div style="text-align: center;"> <p>Good Environment</p> <p>Bad Environment</p> </div> <div style="border-left: 1px dashed black; width: 1px; height: 100%;"></div> <div style="text-align: center;"> <p>More Sensitive</p> <p>Less Sensitive</p> </div> </div>
	2	Weaker	
	3	Weaker	
	● 4	Normal	
	5	Strong	
	6	Stronger	
<ul style="list-style-type: none"> This function is weighing environment dependent. When fast weighing is needed, then the filter should be weaker for a faster display response. 			

Set ZERO Range

<div style="font-size: 2em; font-weight: bold;">F 05</div>	● /	±2% of weighing platform Full Capacity
	□ 2	±10% of weighing platform Full Capacity
	<p>The ZERO key works only if the display is within the set ±2% or ±10% limit of the weighing platform Full Capacity.</p>	

Motion Detection Condition

<div style="font-size: 2em; font-weight: bold;">F 06</div>	01 thru 19	<p>This modifies the "stable" condition by the counts per time of non-movement before the AD-4323 recognizes the stable condition. The fewer counts per longer time are more likely to recognize the stable condition and vice versa.</p>
	00 always stable	
	<p>count</p>	

Automatic ZERO Tracking Compensation (rate of drift from ZERO)

<div style="font-size: 2em; font-weight: bold;">F 07</div>	01 thru 19	seconds <div style="font-size: 1.5em;">01</div> divisions ↑	<p>The ZERO Tracking Comp. function will automatically bring the display back to "zero" when there are small deviations.</p>
	00 Disable	0 = 1 second 1 = 2 seconds 2 = 0.5 Div.'s 3 = 1.0 Div.'s 4 = 1.5 Div.'s 5 = 2.0 Div.'s 6 = 3.0 Div.'s 7 = 4.5 Div.'s	
	<p>seconds</p>		

For example: Puddles of rain form on the weighing platform. Within the limits you set, the AD-4323 will ignore the rain and automatically bring the display to "zero" for easier weighing. So, if your max. capacity = 1.000 lb, min. div. = 1D (0.001 lb) and you set "F 07" function at "02" - every second the AD-4323 will check if more rain than 0.001 lb (1 D) has collected. If it's less, then the display will automatically "zero". If it's more, it will not - you will have to press the ZERO key, and the cycle will start again at the new "zero".

• "02" Setting •
1 sec - 1 Div.

Slope of puddles forming:
less than 0.001 lb per second - display will automatically "zero"

Slope of puddles forming:
more than 0.001 lb per second - display will not automatically "zero"

Holding Mode

Normal Hold

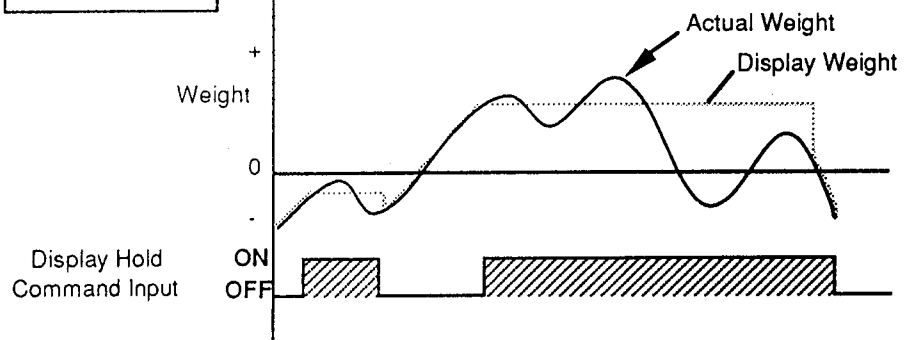

Display is LOCKED when Command Input is ON

F 08

Peak Hold

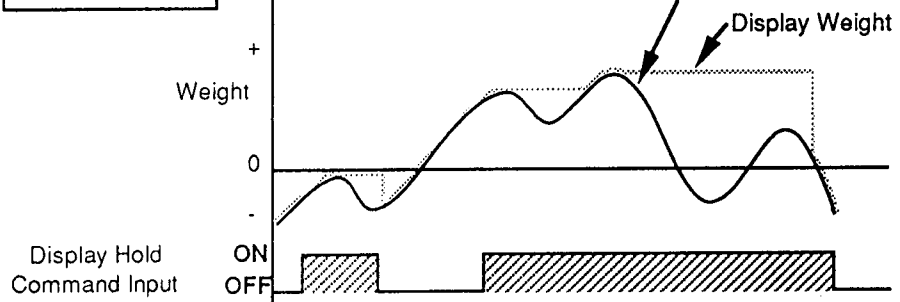

Display is LOCKED when Command Input is ON, but will be replaced when new peak data is entered.

Note

The **ZERO**, **TARE** and **TARE RESET** commands will not work while the display has been locked.

When the display is locked, the ▼ indicator between the **MD** and **GROSS** will come ON.

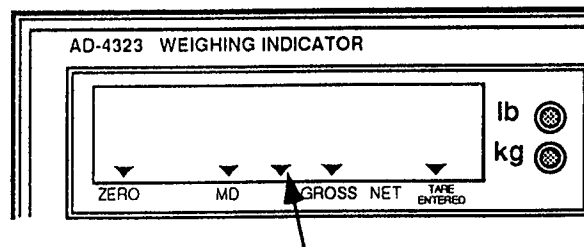

Comparison Result Output Mode

F 09

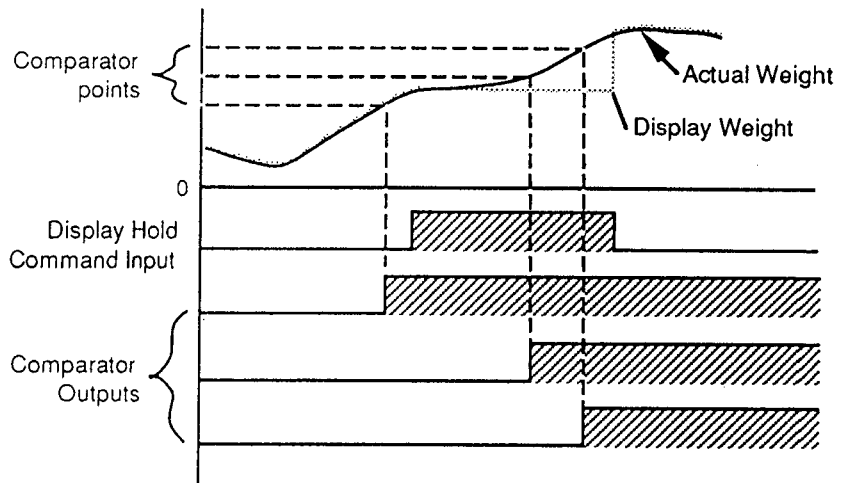

Comparison result is always output

2

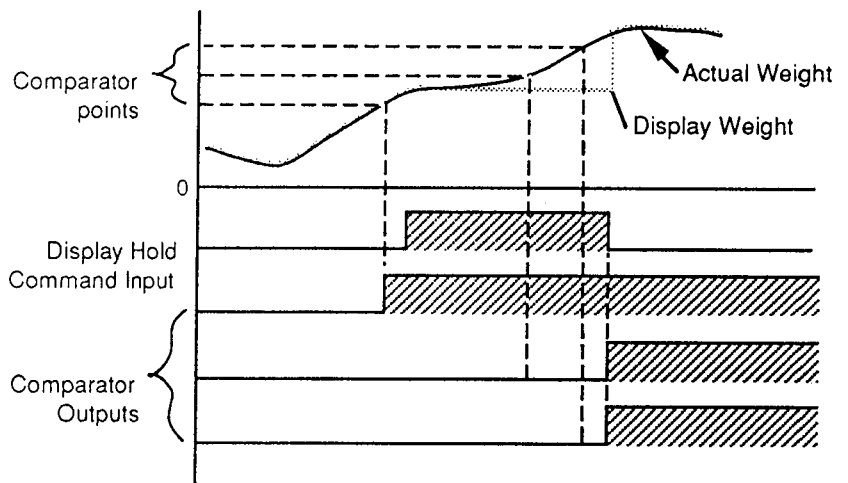

Comparison result is locked when the display is locked

Note

The **ZERO**, **TARE** and **TARE RESET** commands will not work while the display has been locked.

When the display is locked, the ▼ indicator between the **MD** and **GROSS** will come ON.

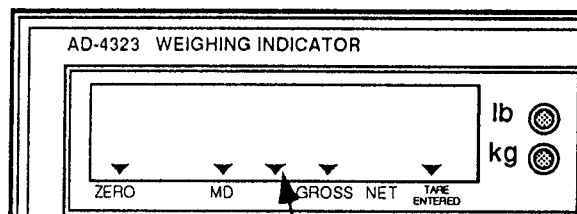

For Batching

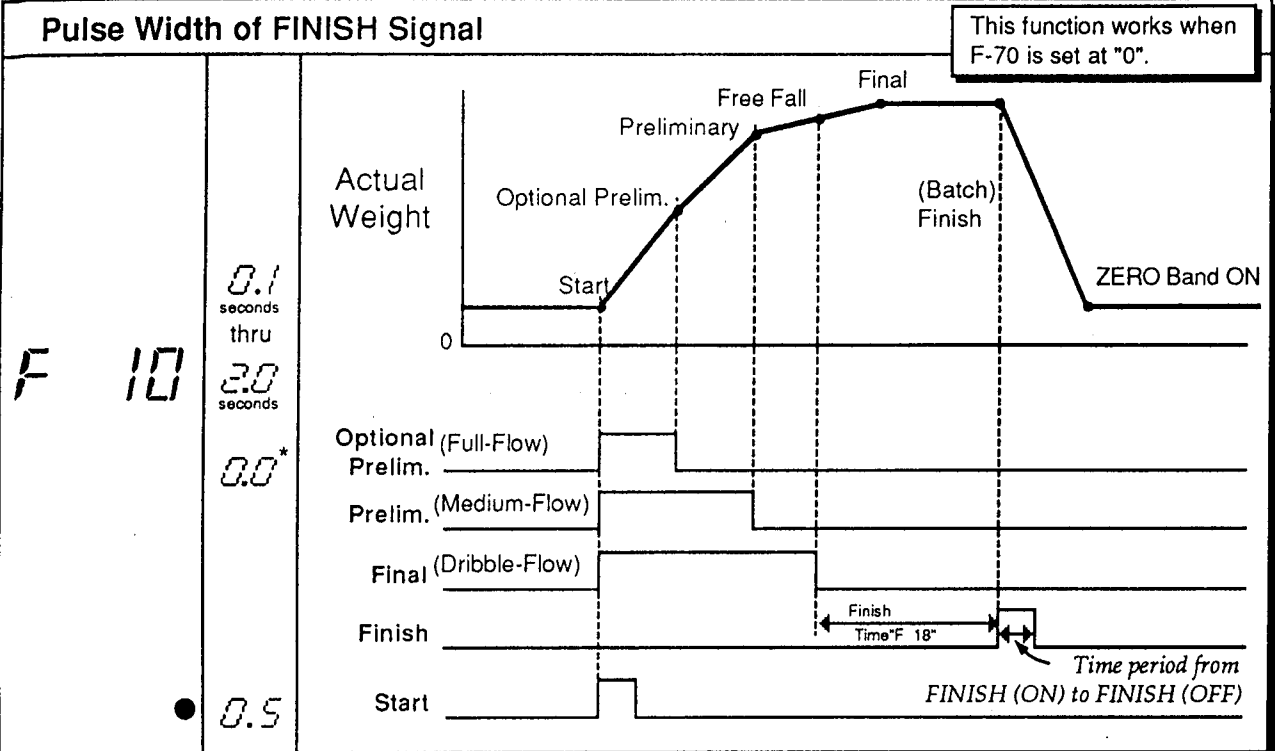

This setting sets the time period from when the FINISH signal is ON to when it goes OFF. *note:* Works only with batching built-in program mode.
 * "0.0" = FINISH signal sent ON, and stays ON until the next START signal.

ZERO Band

F	11	Input the weight where the AD-4323 will read "zero" (empty).
----------	-----------	--

Optional Preliminary Weight

This function works when F-70 is set at "0".

F	12	Input the weight of the Optional Preliminary Weight.
----------	-----------	--

Timer - Comparator Inhibiter

This function works when F-70 is set at "0".

F 13

0.1
thru
2.0

0.0
Disable

The Comparator Input Inhibiter can be set between 0.1 seconds and 2.0 seconds. If there are strong vibrations, the peaks could be mistaken for the next setpoint.

note: 0.1 = 0.1 seconds
2.0 = 2.0 seconds

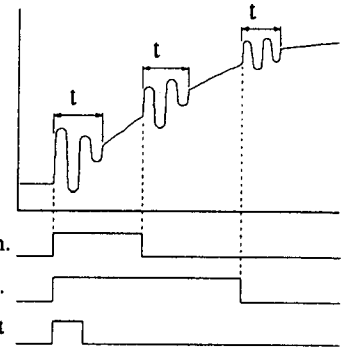

This setting depends on vibration. If there is little, or no vibration, then the Function is not needed ("0.0"). The stronger the vibration, the longer the time needed. note: Works only with batching built-in-program modes.

Automatic Free Fall Compensation Range

This function works when F-70 is set at "0".

F 14

Enter in Free Fall compensation range weight (Disabled = 0) If 1kg is entered, the range is then 1kg lower, or higher, of the Final setpoint. A 2kg total range.

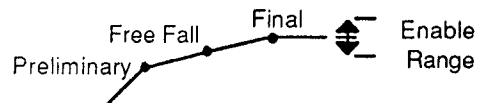

Note

F-15 has two different types of settings, depending on how F-70 is set - at "0" or "1":

Measurement Mode		When F-70 is set at "0", these settings apply:	
F 15	Customer Programmed Control Mode ●	1	Normal Batching
		2	Loss-in-Weight Batching
	Built-in Automatic Program Mode	3	Normal Batching
		4	Loss-in-Weight Batching

Comparison Mode		When F-70 is set at "1", these settings apply:	
F 15 ●	1	Comparison Mode 1	
	2	Comparison Mode 2	
	3	Comparison Mode 3	
	4	Comparison Mode 4	
	5	Comparison Mode 5	

TARE and ZERO keys Availability (Not available on USA version)

F 16 ●	1	ZERO & TARE keys only work when display is STABLE
	2	ZERO & TARE keys always work (used in Batching Mode).

TARE key Availability (Not available on USA version)

F 17 ●	1	If the GROSS is negative (-), TARE does not work.
	2	TARE always works (used in Batching Mode).

Timer - Finish Signal

This function works when F-70 is set at "0".

F 18 ●	0.1 thru 9.9	<p>This Finish Signal Timer can be set between 0.1 seconds and 9.9 seconds. It adjusts the time from the Final signal to the (batch) Finish signal when there are strong vibrations. Setting "0.0" sends the output Finish signal only when the display is stable.</p> <p>note: 0.1 = 0.1 seconds 9.9 = 9.9 seconds</p> <p>note: Works only with the batching built-in program mode.</p>
	0.0 Output when stable	

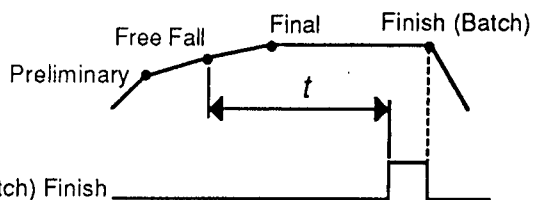

For the International Version

International Version ONLY
NOT USA VERSION

Panel Key Disable Selection - Mode 1

This function allows you to select front panel keys not to be disabled when you are in Mode 1 - Disable Front Panel Keys.

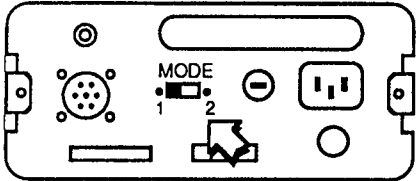
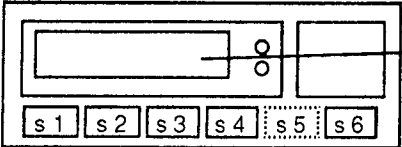



s1 s2 s3 s4 s5 s6

Legend:
 "1" means the key is disabled,
 "0" means the key is enabled.

● Factory setting is "1111-11"
ALL KEYS DISABLED.

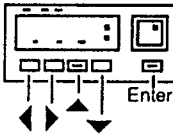
Use the keys in the manor shown to move through the settings and press s6 Enter when settings are correct.



For Standard Current Loop

Baud Rate (serial out for display/printer)		
F 21 ●	1	600 BPS
	2	2400 BPS

Output Data		
F 22 ●	1	Same as Display
	2	Gross Data
	3	Net Data
	4	Tare Data
	5	Gross Data, Net Data, Tare Data

Output Mode		
F 23 ●	1	Stream
	2	Auto Print Mode
	3	Print only when PRINT key is pressed

Output Availability		
F 24 ●	1	Always Available
	2	Output when Stable Only

For BCD Option OP-01

Output Data		
F 31 ●	1	Same as Display
	2	Gross Data
	3	Net Data
	4	Tare Data

Output Mode		
F 32 ●	1	Stream
	2	Auto Print Mode
	3	Print only when PRINT key is pressed

Output Logic		
F 33 ●	1	Positive Logic
	2	Negative Logic

For Serial Interface Option OP-04

Baud Rate		
F 41 ●	1	600 BPS
	2	1200 BPS
	3	2400 BPS
	4	4800 BPS
	5	9600 BPS

Output Data		
F 42	1	Same as Display -Update rate=F 03
	2	Gross Data -Update rate = F 03
	3	Net Data -Update rate = F 03
	4	Tare Data -Update rate = F 03
	5	Gross, Net , & Tare Data -Update rate = F 03
	6	Gross Data -Update rate = 70/sec
	7	Net Data -Update rate = 70/sec

Output Mode		
F 43	1	Stream
	2	Auto Print Mode
	3	Print only when PRINT key is pressed
	4	Command Mode #1
	5	Command Mode #2

Output Availability		
F 44	1	Always Available
	2	Output when Stable Only

For Analog Option OP-07

Analog Output Data		
F 51	1	Same as Display
	2	Gross Data
	3	Net Data

Output Current at Display Zero		
F 52	0.0 thru 99.9	0.0mA through 99.9mA <i>Factory set at "4.0" mA</i>

Output Current at Full Scale		
F 53	0.0 thru 99.9	0.0mA through 99.9mA <i>Factory set at "20.0" mA</i>

For Check Weighing

High High Limit Weight

This function works when F-70 is set at "1".

F 61

Input the weight of the High High Limit Weight.

High Limit Weight

This function works when F-70 is set at "1".

F 62

Input the weight of the High Limit Weight.

Low Limit Weight

This function works when F-70 is set at "1".

F 63

Input the weight of the Low Limit Weight.

Low Low Limit Weight

This function works when F-70 is set at "1".

F 64

Input the weight of the Low Low Limit Weight.

Weighing Mode

Weighing Mode

F 70

0

Batch Weighing Mode

1

Check Weighing Mode

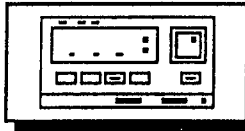

AD-4323 Weighing Indicator

I/O Interfacing

CONTROL I/O EXTERNAL INTERFACE BATCH MODE

Used when F-70 is set at "0"
BATCH WEIGHING MODE

■ Pin Assignment:

Pin	Signal Name	
A-1	ZERO Input	AD-4323 returns to the center of ZERO when the weighing device is empty.
A-2	TARE Input	AD-4323 switches to NET mode, ZERO's the display and stores the TARE weight in memory.
A-3	TARE Reset	TARE value is cleared "0".
A-4	Built-In Program Mode Start Batch Input	Batching will be started when this input is shorted to common (A8)
	Customer Program Mode Setpoint 'data' read inhibit input	When input is shorted to common (A8), AD-4323 will stop to get the data from setpoints, keeping the previous data.
A-5	Built-In Program Mode Abort the Batch	If this input is shorted to common (A8), the batch is aborted - and (batch) FINISH signal is sent.
	Customer Program Mode Automatic Free Fall comp. Command	When input is shorted to common (A8), AD-4323 will estimate the Free Fall value for the next batch.
A-6	Display HOLD/PRINT command Input.	1) • When the data outputs is set to Print Key Mode, this Pin will be PRINT command Input. • If this command is accepted, data output will be sent one time.
		2) • When all data output is not set at Manual Print mode, this pin will be display HOLD input. • When this pin is shorted to common (A8), all data output and display will be frozen.
A-7	Error Output	1) If Gross weight is out of the 2%/10% ZERO range when ZERO input is accepted. 2) Overload, or Underload.
A-8	Common	

B-1	ZERO Band Output	B-5	Hi Limit Ouptut
B-2	Optional Prelim. Ouptut	B-6	Lo Limit Ouptut
B-3	Prelim. Ouptut	B-7	Batch Finish Output
B-4	Final Ouptut	B-8	Motion Detection Ouptut <small>Closed (ON) when in motion</small>

INPUT

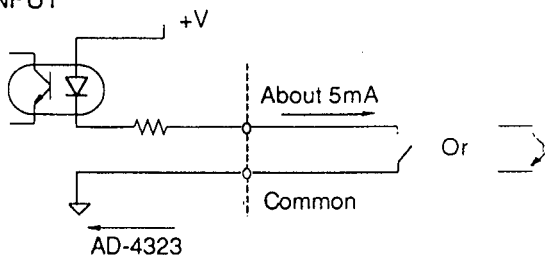

OUTPUT

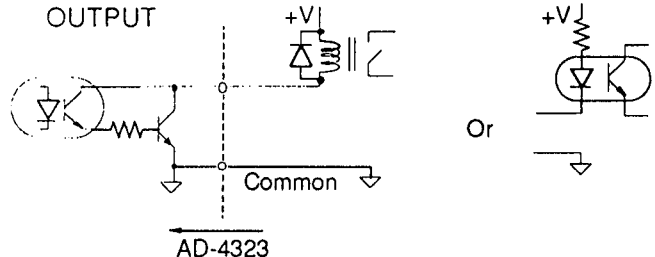

- With the above OUTPUT circuit , please use optical isolator or relay.
- The excitation (or driving) capacity of these relays are 24V 50mA DC maximum.
- The width of these inputs are at least 200msec.

SETPOINT EXTERNAL INTERFACE BATCH MODE

Used when F-70 is set at "0"
BATCH WEIGHING MODE

■ *Push Button Thumbwheels*

The following groups of thumbwheel switches can be directly interfaced:

- | | |
|-------------------------------|--------------------------|
| (a) Final Weight (5 digits) | (b) Free Fall (3 digits) |
| (c) Prelim. Weight (4 digits) | (d) Hi Limit (2 digits) |
| (e) Lo Limit (2 digits) | |
- If Min. Division is ≥ 10 : then (a), (b), (c), (d) and (e) will be multiplied by ten before the Comparator compares the data.
 - The Least Significant Digit (LSD) of a thumbwheel switch group corresponds to the LSD of the weight display.

■ *Setpoint Condition*

Output closes under the following conditions, depending on the customer programmed mode:

	<input type="checkbox"/> <u>Output</u>	<input type="checkbox"/> <u>Condition</u>
	ZERO Band Output	"Gross Weight" < "ZERO Band".
Normal Mode	Optional Prelim Output	"Net weight" \geq "Final" - "Optional Prelim".
Loss-in Mode	Optional Prelim Output	"Gross weight" > "Optional Prelim".
	Preliminary Output	"Net Weight" \geq "Final" - "Preliminary".
	Final Output	"Net Weight" \geq "Final" - "Free Fall".
	Hi Limit Output	"Net Weight" > "Final" + "Hi Limit".
	Lo Limit Output	"Net Weight" < "Final" - "Lo Limit".

■ *Pin Numbers*

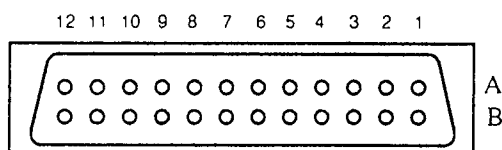

Attention

- The Input cable should be no longer than 20 inches (50cm max.).
- The optional "Preliminary (Prelim)" weight is set by F-Function. See F-12 page 41.

Setpoint Wiring Diagram and Input Pins

Used when F-70 is set at "0"
BATCH WEIGHING MODE

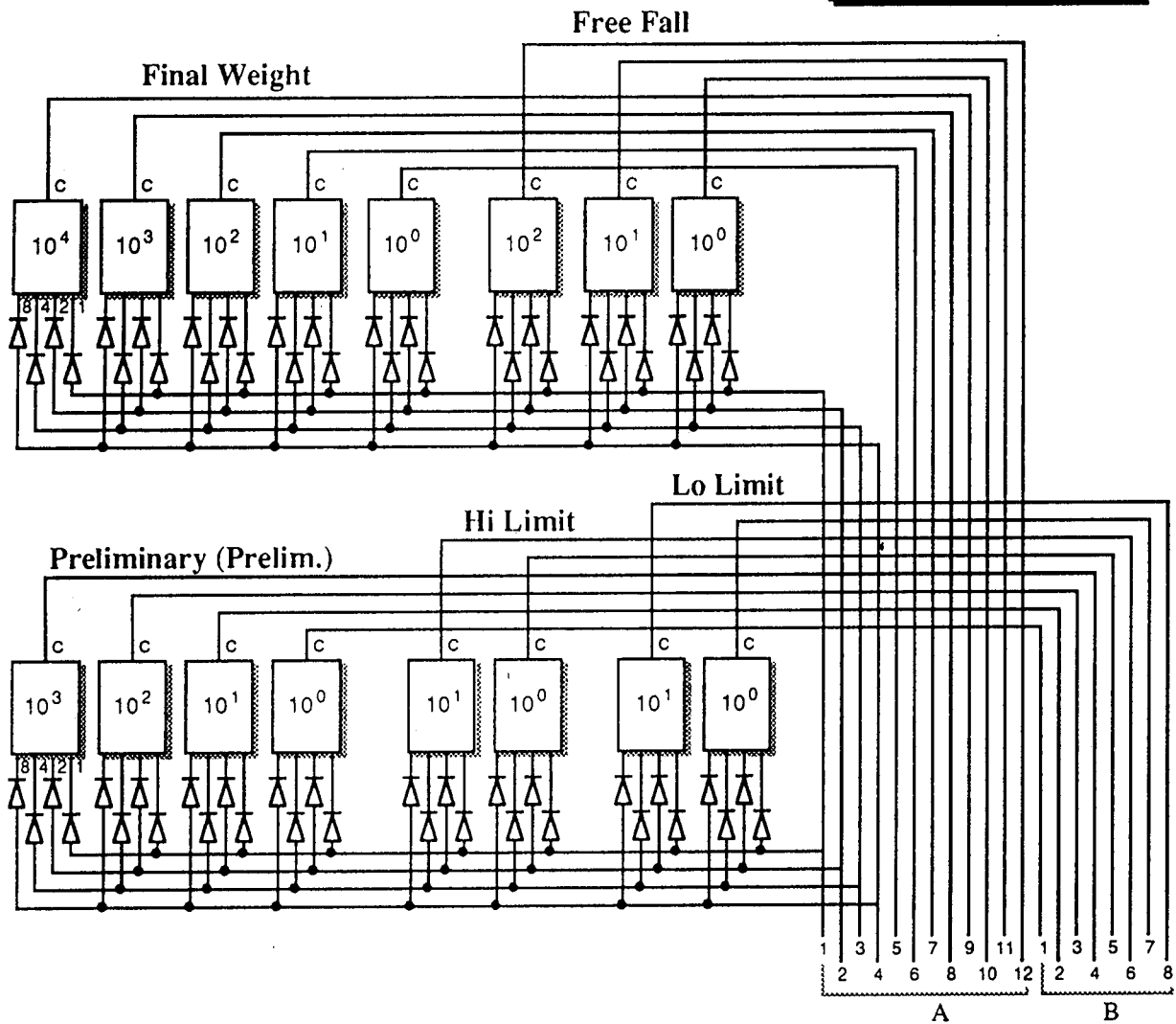

Pin	Signal	Pin	Signal
A-1	1	B-1	Prelim. 10 ⁰ Common
A-2	2	B-2	Prelim. 10 ¹ Common
A-3	4	B-3	Prelim. 10 ² Common
A-4	8	B-4	Prelim. 10 ³ Common
A-5	Final Weight 10 ⁰ Common	B-5	Hi Limit 10 ⁰ Common
A-6	Final Weight 10 ¹ Common	B-6	Hi Limit 10 ¹ Common
A-7	Final Weight 10 ² Common	B-7	Lo Limit 10 ⁰ Common
A-8	Final Weight 10 ³ Common	B-8	Lo Limit 10 ¹ Common
A-9	Final Weight 10 ⁴ Common	B-9	
A-10	Free Fall 10 ⁰ Common	B-10	
A-11	Free Fall 10 ¹ Common	B-11	Internal Use
A-12	Free Fall 10 ² Common	B-12	Shield (SHD)

TIMING - NORMAL BATCHING

F-15 is set at "1"
F-70 is set at "0"

Customer Programmed Control Mode

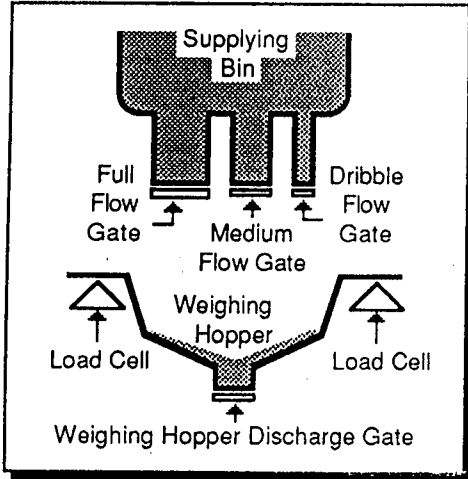

■ In this example:

- AD-4323 means performed by the AD-4323 controller; •Program means performed by a customer generated program; •Operator or Program means performed by an operator, or by the customer generated program.
- Pin Numbers refer to the Control I/O Interface.
- The following are connected: •Optional Prelim Output (pin B2) to the Weighing Hopper Full-Flow Gate controller; •Prelim Output (pin B3) to the Medium-Flow Gate controller; and •Final Output (pin B4) to the Dribble-Flow Gate controller.

Start	The Weighing Hopper is empty, the display shows "0", and all Gates are closed.
Operator or Program	If the display is not at Zero, input a Tare signal (pin A2) to Rezero the display (please use a Zero signal (A1) for multiple ingredient batching).
Operator or Program	Open the Supplying Bin's: Full-Flow Gate, Medium-Flow Gate, and Dribble-Flow Gate.
AD-4323	When the display reaches Optional Prelim. (Final minus Optional Prelim. value - see F-Function "F-12"), the Optional Prelim. Output signal will be sent, or - "come ON".
Program	Close the Full-Flow Gate by using the Optional Prelim. Output ON signal.
AD-4323	When the display reaches Prelim. (Final minus Prelim. value) the Prelim. Output signal will be sent, or - "come ON".
Program	Close the Medium-Flow Gate by using the Prelim. Output ON signal.
AD-4323	When the display reaches Free Fall. (Final minus Free Fall value) the Final Output signal will be sent, or - "come ON".
Program	Close the Dribble Gate by using the Final Output ON signal.
Program	After Free Fall has stopped - Check that the Hi Limit, and Lo Limit signals are OFF. If both outputs are OFF then the batch is completed correctly.
Note	If you wish to use the Automatic Free Fall Compensation ("F-14") - please input the Free Fall Compensation Command via the Control I/O interface Pin A5. The Free Fall value will then be changed to the new value. If you change the Free Fall setpoint by the Thumbwheel switch -

then the learned Free Fall value will be cleared and the new setpoint Free Fall value is entered.

Program The AD-4323 does not have a Discharge Gate control for the Weighing Hopper - use the Final signal plus a time period as the control signal to open the Weighing Hopper Discharge Gate.

AD-4323 When the Gross weight is below Zero Band ("F-11"), the Zero Band Output will come ON - signifying the weighing Hopper is empty.

Program Close the Weighing Hopper Discharge Gate by using the Zero Band Output ON signal.

AD-4323 Ready for next batching event.

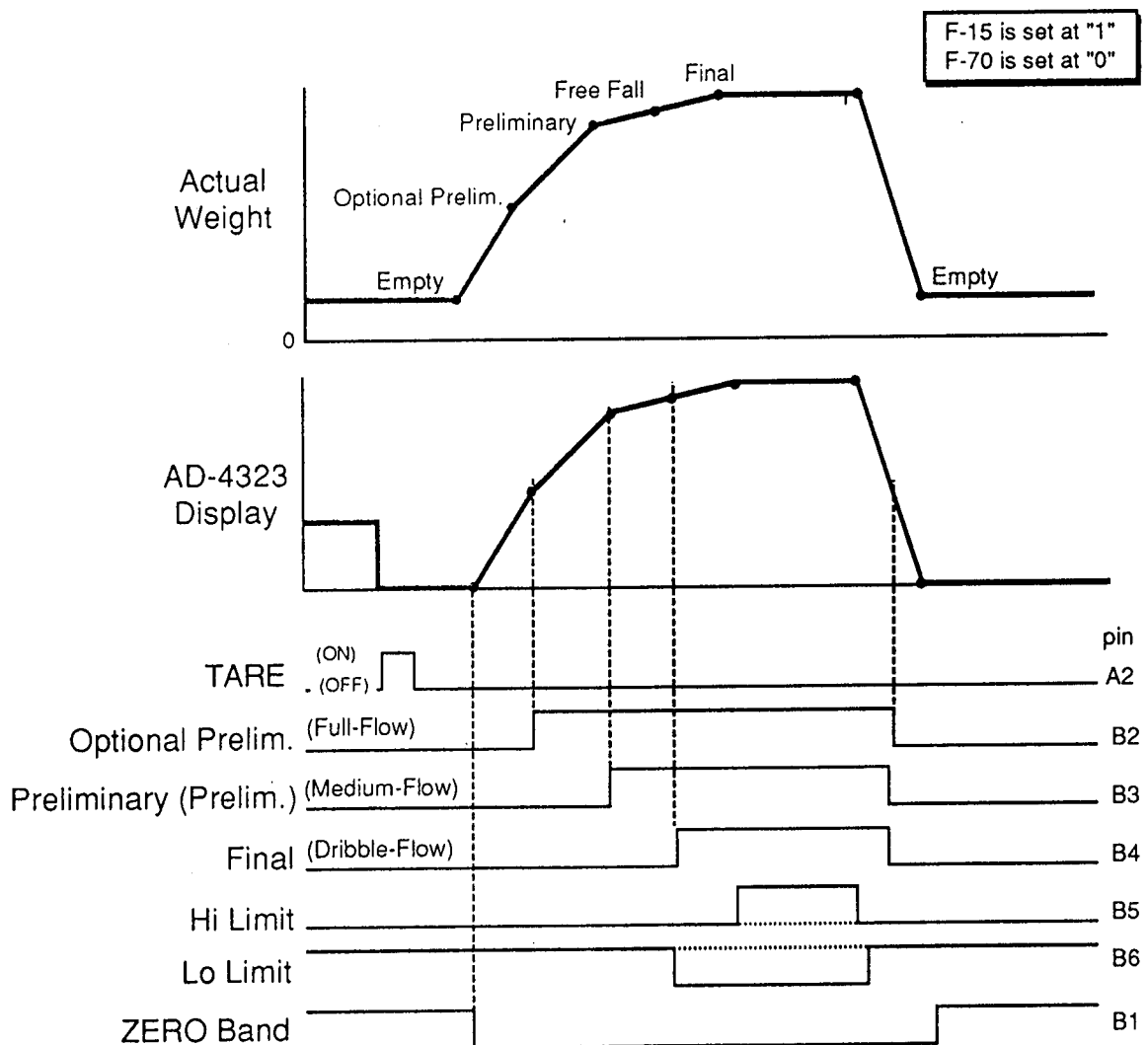

TIMING - LOSS-IN-WEIGHT

F-15 is set at "2"
F-70 is set at "0"

Customer Programmed Control Mode

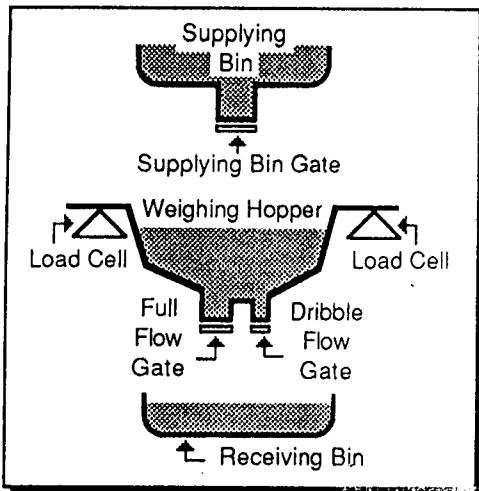

■ In this example:

- AD-4323 means performed by the AD-4323 controller; •Program means performed by a customer generated program; •Operator or Program means performed by an operator, or by the customer generated program.
- Pin Numbers refer to the Control I/O Interface.
- The following are connected: •Optional Prelim Output (pin B2) to the Supplying Bin Gate controller; •Prelim Output (pin B3) to the Weighing Hopper Full-Flow Gate controller; and •Final Output (pin B4) to the Weighing Hopper Dribble-Flow Gate controller.

Start	The Weighing Hopper is empty as is the Receiving Bin . The display shows "0". All Gates are closed.
Operator or Program	Open the Supplying Bin Gate.
AD-4323	When the display reaches Optional Prelim. (Optional Prelim. value - see F-Function "F-12"), then the Optional Prelim. Output signal will be sent, or - "come ON".
Program	Close the Supplying Bin Gate by using the Optional Prelim. Output ON signal.
Note	The displayed weight will exceed the Optional Prelim. value by the Free Fall value. This weight is not necessarily accurate - but accuracy is not need here since the purpose of this event is to fill up the Weighing Hopper. The Optional Prelim value is always compared to Gross weight.
Operator or Program	Input a Tare signal (pin A2) to Zero the display.
AD-4323	Display goes to Zero.
Operator or Program	Open Hopper Full-Flow Gate and Weighing Hopper Dribble-Flow Gate for Full-Flow filling into the Receiving Bin.
AD-4323	When the display reaches Prelim. (Final minus Prelim. value) the Prelim. Output signal will be sent, or - "come ON".
Program	Close the Hopper Full-Flow Gate using the Prelim. Output ON signal.
Comment	Full-Flow filling is now completed.
AD-4323	When the display reaches Free Fall. (Final minus Free Fall value) the Final Output signal will be sent, or - "come ON".

- Program** | Close the Weighing Hopper Dribble-Flow Gate by using the Final Output ON signal.
- AD-4323** | After Free Fall has stopped, the display may show the Final value.
- Note** | If you use the Hi Limit and Lo Limit signal, please check that both Hi and Lo Limit's signals are OFF - meaning the final weight is with acceptable limits, and the Receiving Bin has received the correct weight.
- AD-4323** | If the Gross Weight of the Weighing Hopper is below the Zero Band Setpoint ("F-11")- the Zero Band Output will be ON.
- Note** | Please use Zero Band Output for refilling if needed.
- AD-4323** | Ready for next batching event.

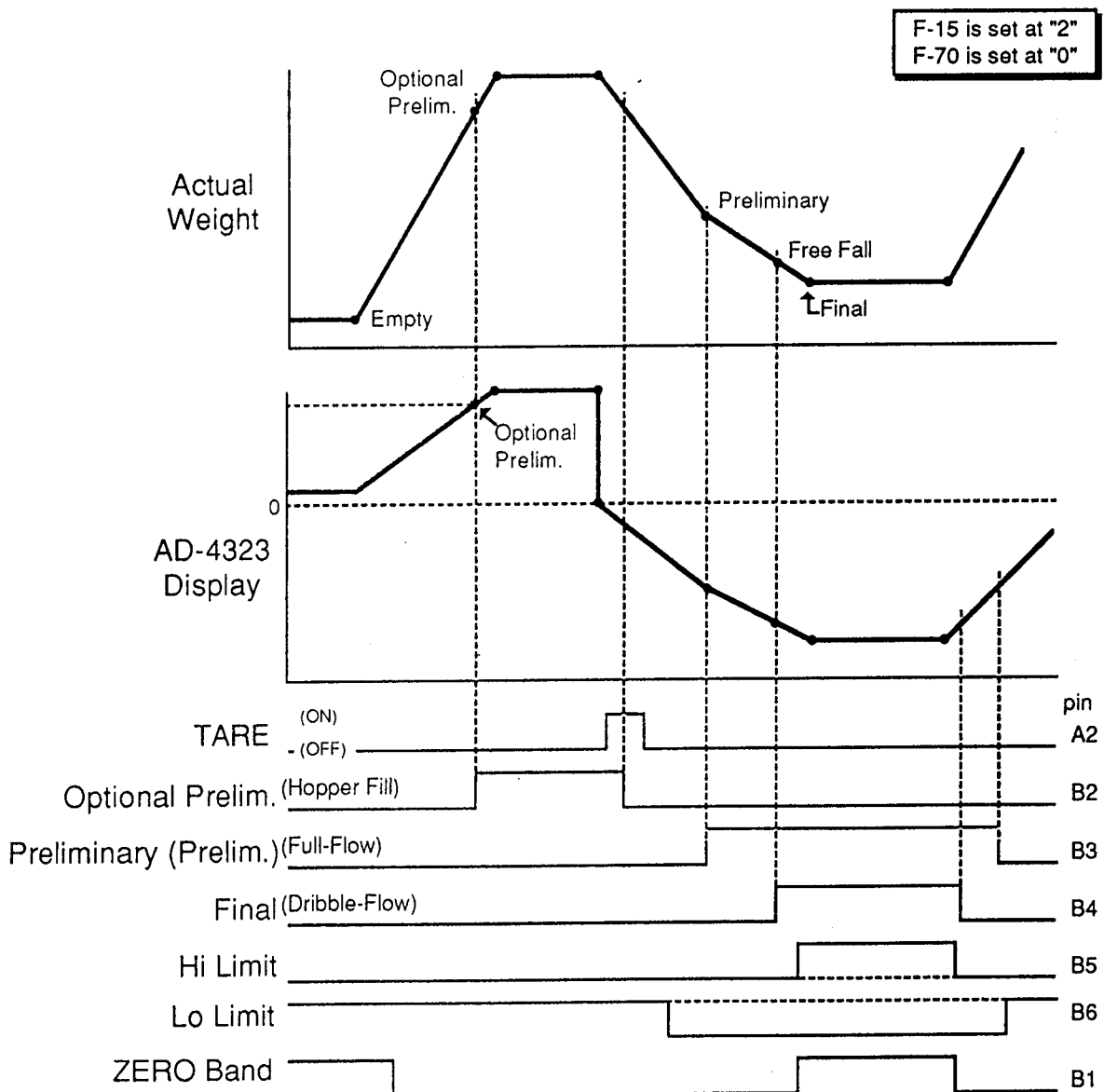

TIMING - NORMAL BATCHING

F-15 is set at "3"
F-70 is set at "0"

Built-in Automatic Program

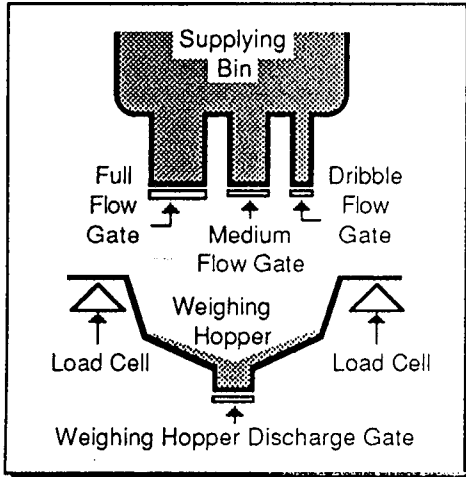

■ In this example:

- AD-4323 means performed by the AD-4323 controller; •Built-In Auto Program means performed by the AD-4323 Built-In Automatic Program controller; •Operator or Program means performed by an operator, or by a customer generated program.
- Pin Numbers refer to the Control I/O Interface.
- The following are connected: •Optional Prelim Output (pin B2) to the Weighing Hopper Full-Flow Gate controller; •Prelim Output (pin B3) to the Medium-Flow Gate controller; and •Final Output (pin B4) to the Dribble-Flow Gate controller. •Start signal Input is from pin A4.

Start	The Weighing Hopper is empty, the display shows "0", and all Gates are closed.
Operator or Program	If the display is not at Zero, please input a Tare signal (pin A2) to Rezero the display (please use a Zero signal (A1) for multiple ingredient batching).
Operator or Program	Check that the Weighing Hopper is empty by using the Zero Band Output ("F-11"). Input the Start signal via the control I/O interface connector (A4).
Built-In Auto Program	When the Start signal is received, the: Optional Prelim. (see F-Function "F-12"), Prelim., and Final Outputs go ON.
Comment	If Gate switch control relays are connected as listed above - the Supplying Bin Gates will be opened using the Optional Prelim., Prelim., and Final Output - ON signal.
AD-4323	When the display reaches Optional Prelim. (Final minus Optional Prelim. value), the Optional Prelim. Output signal will be OFF.
Comment	The Full-Flow Gate will be closed by using the Optional Prelim. Output OFF signal.
AD-4323	When the display reaches Prelim. (Final minus Prelim. value), the Prelim. Output signal will be OFF.
Comment	The Medium-Flow Gate will be closed by using the Prelim. Output OFF signal.
AD-4323	When the display reaches Free Fall (Final minus Free Fall value), the Final Output signal will be OFF.
Comment	The Dribble Gate will be closed by using the Final Output OFF signal.

Built-In Auto Program

Batch Finish signal is sent after the set time period (see "F-18") or when display is stable ("F-18" default).

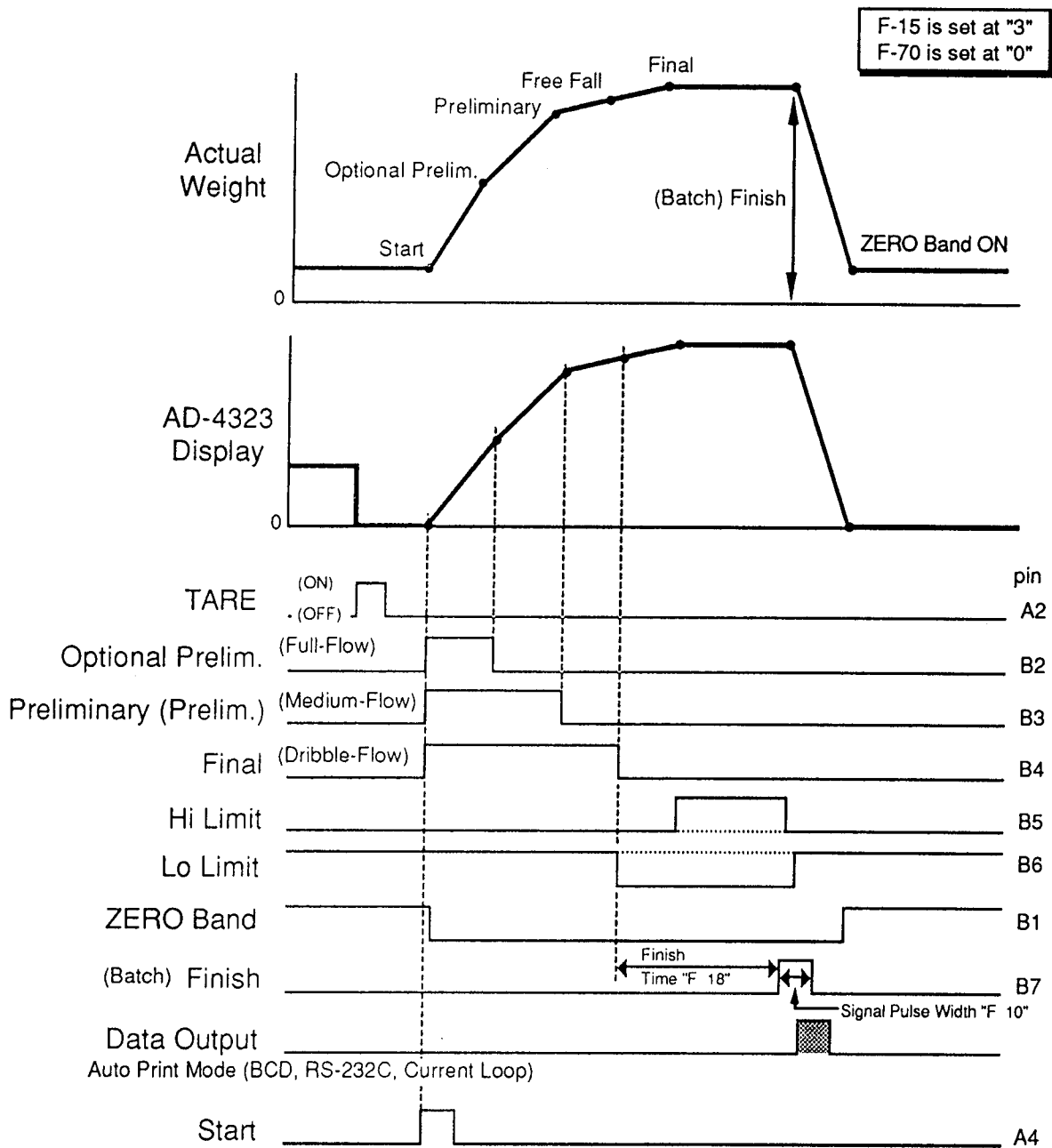

Operator or Program

If you use Hi and Lo Limits - after Free Fall has stopped - check that both signals are OFF. If both outputs are OFF then the batch is completed correctly.



Automatic Free Fall ("F-14") is now recalculated for the next event. If you change the Free Fall setpoint by the Thumbwheel switch - then the learned Free Fall value will be cleared and the new setpoint Free Fall value is entered.

Comment

The Weighing Hopper Discharge Gate will be opened by using the Finish Output ON signal.

Built-In Auto Program

Data output is sent (Auto Print Mode: BCD, RS-232C, or Current Loop).

AD-4323

Ready for next batching event.



If an Abort signal is sent (pin A5) anytime after the Start signal is received, then the:

- Optional Prelim., Prelim., and Final signals go to OFF, - Gates will be closed.
- Batch Finish and Data Output signals will be sent.

Also:

During a normal batching event, do not press the **TARE** or **STANDBY/OPERATE** keys.

Also:

Please note that the idea of Free Fall is based upon the concept of solids falling (after the flow has been cut to zero) from a Supplying Bin into a Weighing Hopper. When liquids are being added to a Weighing Hopper, wave propagation must be kept to a minimum to avoid load oscillation. If a submerged filling probe is employed (which may mean zero Free Fall) liquid displacement must be taken into consideration.

TIMING - LOSS-IN-WEIGHT

F-15 is set at "4"
F-70 is set at "0"

Built-in Automatic Program

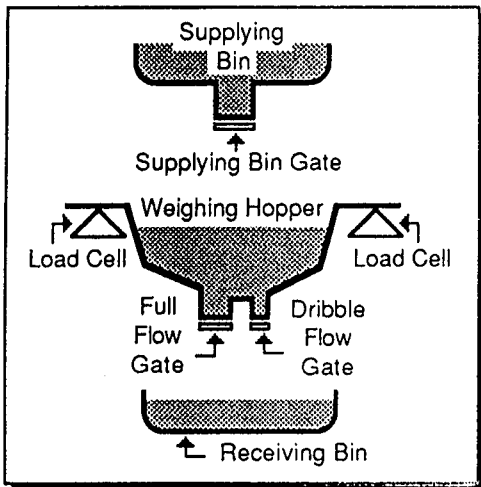

In this example:

- AD-4323 means performed by the AD-4323 controller; •Built-In Auto Program means performed by the AD-4323 Built-In Automatic Program controller; •Operator or Program means performed by an operator, or by a customer generated program.
- Pin Numbers refer to the Control I/O Interface.
- The following are connected: •Optional Prelim Output (pin B2) to the Supplying Bin Gate controller; •Prelim Output (pin B3) to the Weighing Hopper Full-Flow Gate controller; and •Final Output (pin B4) to the Weighing Hopper Dribble-Flow Gate controller. •Start signal Input is from pin A4.

Start	The Weighing Hopper is empty as is the Receiving Bin . The display shows "0". All Gates are closed.
Operator or Program	Open the Supplying Bin Gate.
AD-4323	When the display reaches Optional Prelim. (Optional Prelim. value - see F-Function "F-12"), then the Optional Prelim. Output signal will be sent, or - "come ON".
Comment	If Gate switch control relays are connected as listed above - the Supplying Bin Gate will be closed by using the Optional Prelim. Output ON signal.
	The displayed weight will exceed the Optional Prelim. value by the Free Fall value. This weight is not necessarily accurate - but accuracy is not need here since the purpose of this event is to fill up the Weighing Hopper. The Optional Prelim value is always compared to Gross weight.
Operator or Program	Input a Tare signal (pin A2) to Zero the display.
AD-4323	Display goes to Zero.
Operator or Program	Input the Start signal via the control I/O interface connector (A4).
Built-In Auto Program	When the Start signal is received, the: Prelim. and Final Outputs go ON.
Comment	The Weighing Hopper Full-Flow Gate and Weighing Hopper Dribble-Flow Gate will be opened by using the Prelim. Output and Final - ON signal.

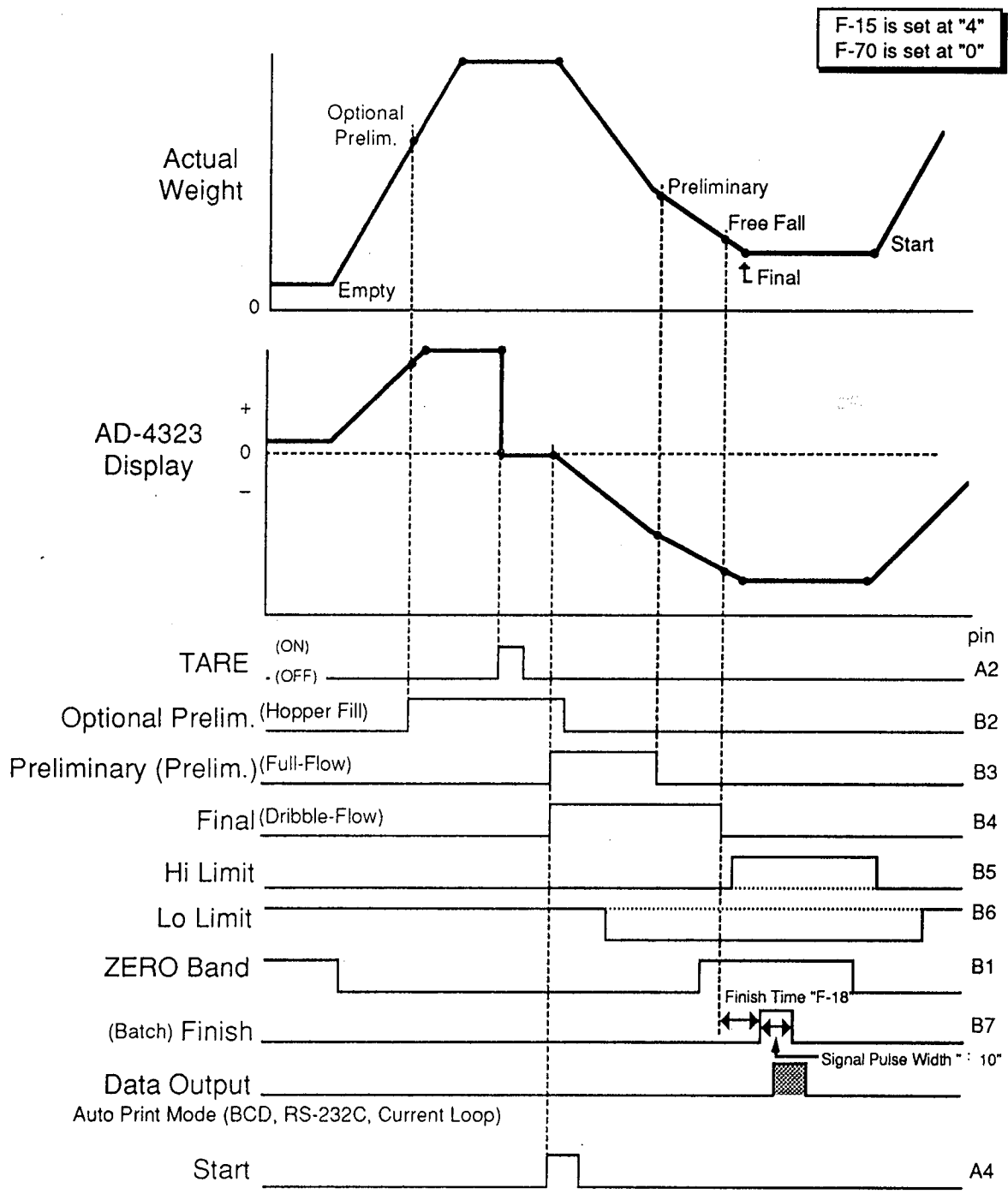

AD-4323 | When the display reaches Prelim. (Final minus Optional Prelim. value), the Prelim. Output signal will be OFF.

Comment | The Weighing Hopper Full-Flow Gate will be closed by using the Optional Prelim. Output OFF signal.

AD-4323 | When the display reaches Free Fall (Final minus Free Fall value), the Final Output signal will be OFF.

Comment | The Weighing Hopper Dribble Gate will be closed by using the Final Output OFF signal.

Built-In Auto Program

Batch Finish signal is sent after the set time period (see "F-18") or when stable ("F-18" default).

AD-4323

After Free Fall has stopped, the display may show the Final value.

Operator or Program

If you use Hi and Lo Limits - after Free Fall has stopped - check that both signals are OFF. If both outputs are OFF then the batch is completed correctly.



Automatic Free Fall ("F-14") is now recalculated for the next event. If you change the Free Fall setpoint by the Thumbwheel switch - then the learned Free Fall value will be cleared and the new setpoint Free Fall value is entered.

Built-In Auto Program

Data output is sent (Auto Print Mode: BCD, RS-232C, or Current Loop).

Note

Please use Zero Band Output for refilling if needed.

AD-4323

Ready for next batching event.



If an Abort signal is sent (pin A5) anytime after the Start signal is received, then the:

- Prelim., and Final signals go to OFF, - Gates will be closed.
- Batch Finish and Data Output signals will be sent.

Also:

During a normal batching event, do not press the **TARE** or **STANDBY/OPERATE** keys.

Also:

Please note that the idea of Free Fall is based upon the concept of solids falling (after the flow has been cut to zero) from a Supplying Bin into a Weighing Hopper. When liquids are being added to a Weighing Hopper, wave propagation must be kept to a minimum to avoid load oscillation. If a submerged filling probe is employed (which may mean zero Free Fall) liquid displacement must be taken into consideration.

CONTROL I/O EXTERNAL INTERFACE CHECK MODE

Used when F-70 is set at "1"
CHECK WEIGHING MODE

■ Pin Assignment:

Pin	Signal Name	
A-1	ZERO Input	AD-4323 returns to the center of ZERO when the weighing device is empty.
A-2	TARE Input	AD-4323 switches to NET mode, ZERO's the display and stores the TARE weight in memory.
A-3	TARE Reset	TARE value is cleared "0".
A-4	Setpoint 'data' read inhibit input	When input is opened, AD-4323 will get the data from the setpoints (thumbwheels). When input is shorted to common (A8), AD-4323 will stop to get the data from setpoints, and from the RS-232C.
A-5	Display HOLD command input	When input is shorted to common (A8), AD-4323 will freeze all data output and the display.
A-6	PRINT command Input.	If this command is accepted, data output will be sent one time.
A-7	Error Output	1) If Gross weight is out of the 2%/10% ZERO range when ZERO input is accepted. 2) Overload, or Underload.
A-8	Common	

B-1	ZERO Band Output		B-5	High Ouput	
B-2	Low Low Ouput		B-6	High High Ouput	
B-3	Low Ouput		B-7	Do Not use this pin!	
B-4	Go Ouput		B-8	Motion Detection Ouput	Closed (ON) when in motion

INPUT

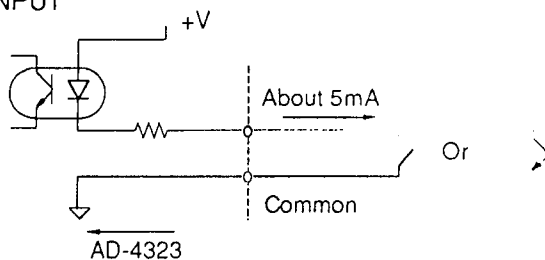

OUTPUT

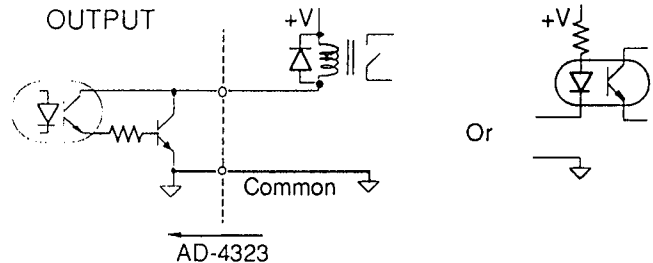

- With the above OUTPUT circuit , please use optical isolator or relay.
- The excitation (or driving) capacity of these relays are 24V 50mA DC maximum.
- The width of these inputs are at least 200msec.

SETPOINT INTERFACE CHECK COMPARISON MODE 1

Used when F-70 is set at "1"
and F-15 is set at "1"
CHECK WEIGHING MODE

■ *Push Button Thumbwheels*

The following groups of thumbwheel switches can be directly interfaced:

- (a) Target Weight (5 digits)
 - (b) High Limit (5 digits)
 - (c) Low Weight (5 digits)
- If Min. Division is ≥ 10 : then (a), (b), and (c) will be multiplied by ten before the Comparator compares the data.
 - The Least Significant Digit (LSD) of a thumbwheel switch group corresponds to the LSD of the weight display.

■ *Setpoint Condition*

Output closes under the following conditions:

- | <input type="checkbox"/> <u>Output</u> | <input type="checkbox"/> <u>Condition</u> |
|--|--|
| ZERO Band Output | "Gross Weight" < "ZERO Band". |
| High High Output | "Net weight" > "High High Limit". |
| High Output | "Net weight" > "Target Weight + High Limit". |
| Go Output | "Target Weight - Low Limit" \leq "Net Weight" \leq "Target Weight + High Limit". |
| Low Output | "Net Weight" < "Target Weight - Low Limit". |
| Low Low Output | "Net Weight" < "Low Low Limit". |

■ *Pin Numbers*

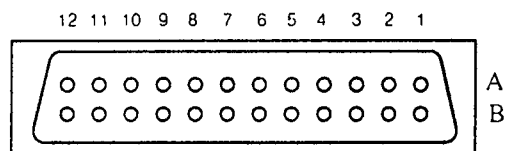

Attention

- The Input cable should be no longer than 20 inches (50cm max.).
- The "High High Limit" and "Low Low Limit" are set by F-Functions. See F-61 and F-64 page 47.

Setpoint Wiring Diagram and Input Pins

Used when F-70 is set at "1"
and F-15 is set at "1"
CHECK WEIGHING MODE

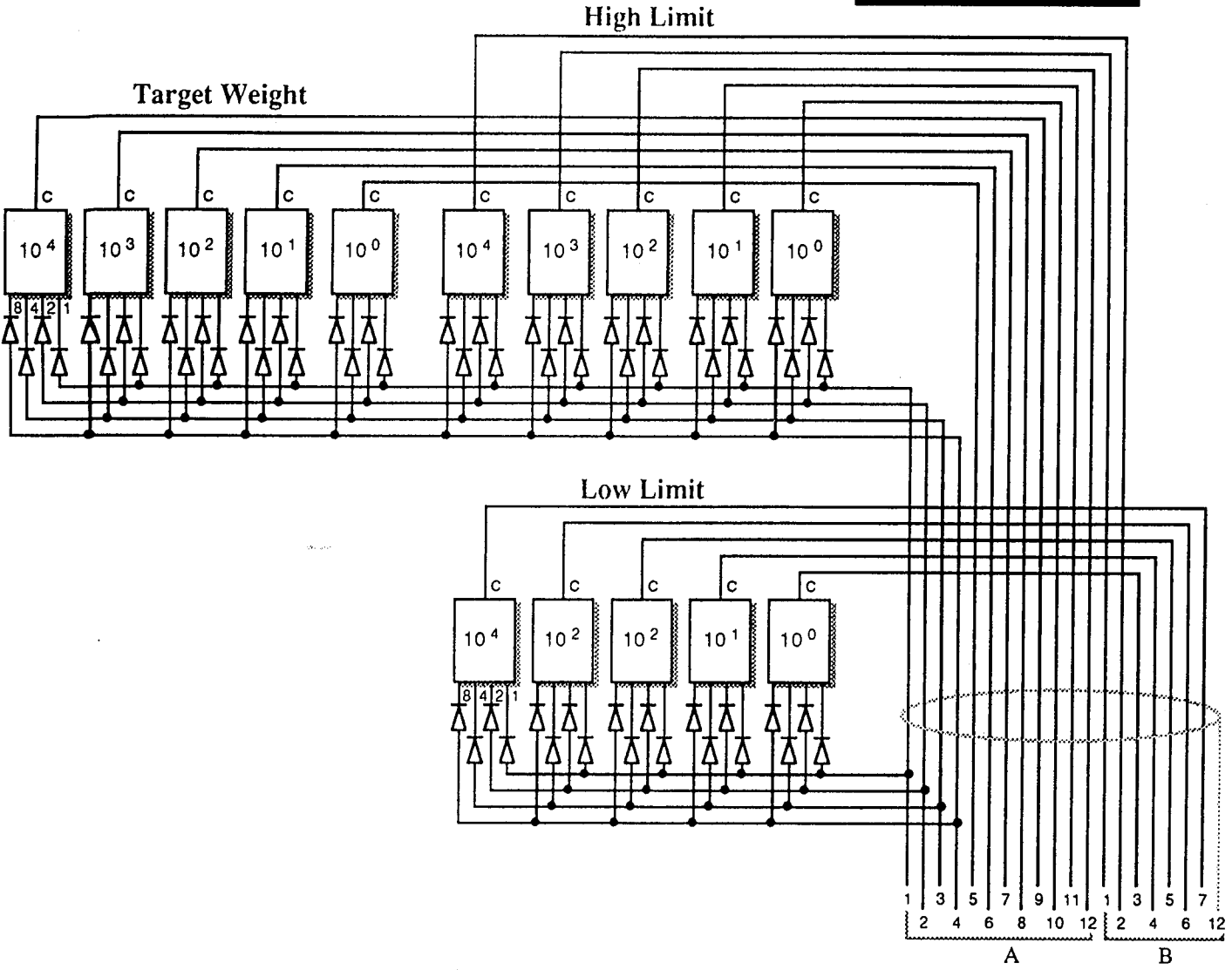

Pin	Signal	Pin	Signal
A-1	1	B-1	High Limit 10 ³ Common
A-2	2	B-2	High Limit 10 ⁴ Common
A-3	4	B-3	Low Limit 10 ⁰ Common
A-4	8	B-4	Low Limit 10 ¹ Common
A-5	Target Weight 10 ⁰ Common	B-5	Low Limit 10 ² Common
A-6	Target Weight 10 ¹ Common	B-6	Low Limit 10 ³ Common
A-7	Target Weight 10 ² Common	B-7	Low Limit 10 ⁴ Common
A-8	Target Weight 10 ³ Common	B-8	
A-9	Target Weight 10 ⁴ Common	B-9	
A-10	High Limit 10 ⁰ Common	B-10	
A-11	High Limit 10 ¹ Common	B-11	Internal Use
A-12	High Limit 10 ² Common	B-12	Shield (SHD)

■ **Comparison Mode 1**

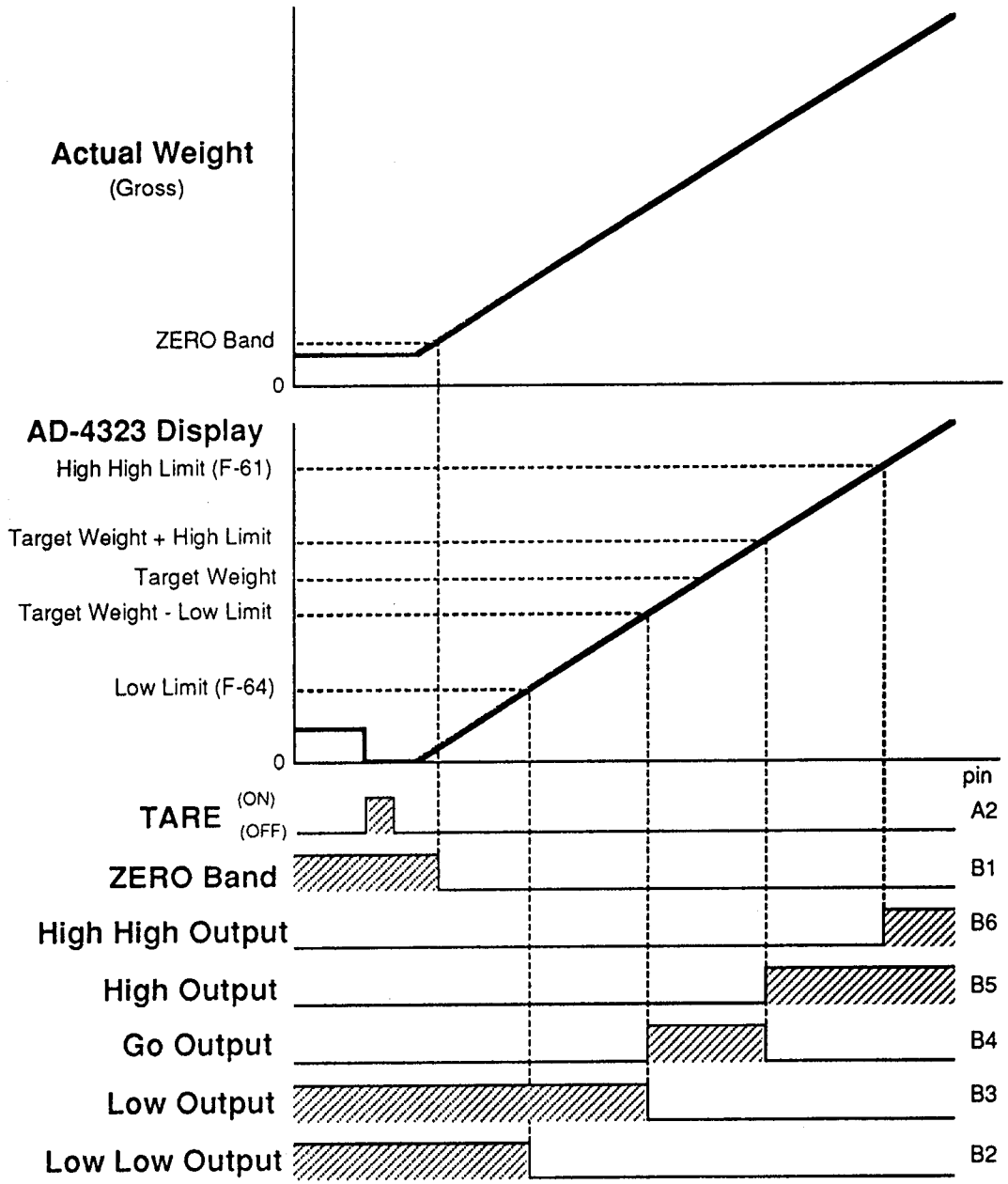

SETPOINT INTERFACE CHECK COMPARISON MODE 2

Used when F-70 is set at "1"
and F-15 is set at "2"
CHECK WEIGHING MODE

■ *Push Button Thumbwheels*

The following groups of thumbwheel switches can be directly interfaced:

- (a) Target Weight (5 digits)
 - (b) High Limit (5 digits)
 - (c) Low Weight (5 digits)
- If Min. Division is ≥ 10 : then (a), (b), and (c) will be multiplied by ten before the Comparator compares the data.
 - The Least Significant Digit (LSD) of a thumbwheel switch group corresponds to the LSD of the weight display.

■ *Setpoint Condition*

Output closes under the following conditions:

- | | |
|--|--|
| <ul style="list-style-type: none"> <input type="checkbox"/> <u>Output</u> ZERO Band Output High High Output High Output Go Output Low Output Low Low Output | <ul style="list-style-type: none"> <input type="checkbox"/> <u>Condition</u> "Gross Weight" < "ZERO Band". "Net weight" > "Target Weight + High High Limit". "Target Weight + High Limit" < "Net Weight" \leq "Target Weight + High High Limit". "Target Weight - Low Limit" \leq "Net Weight" \leq "Target Weight + High Limit". "Target Weight - Low Low Limit" \leq "Net Weight" < "Target Weight - Low Limit". "Net Weight" < "Target Weight - Low Low Limit". |
|--|--|

■ *Pin Numbers*

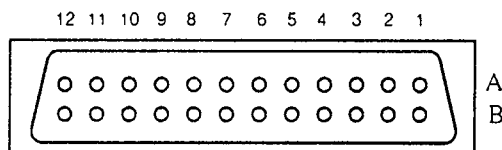

Attention

- The Input cable should be no longer than 20 inches (50cm max.).
- The "High High Limit" and "Low Low Limit" are set by F-Functions. See F-61 and F-64 page 47.

■ Setpoint Wiring Diagram and Input Pins

Used when F-70 is set at "1"
and F-15 is set at "2"
CHECK WEIGHING MODE

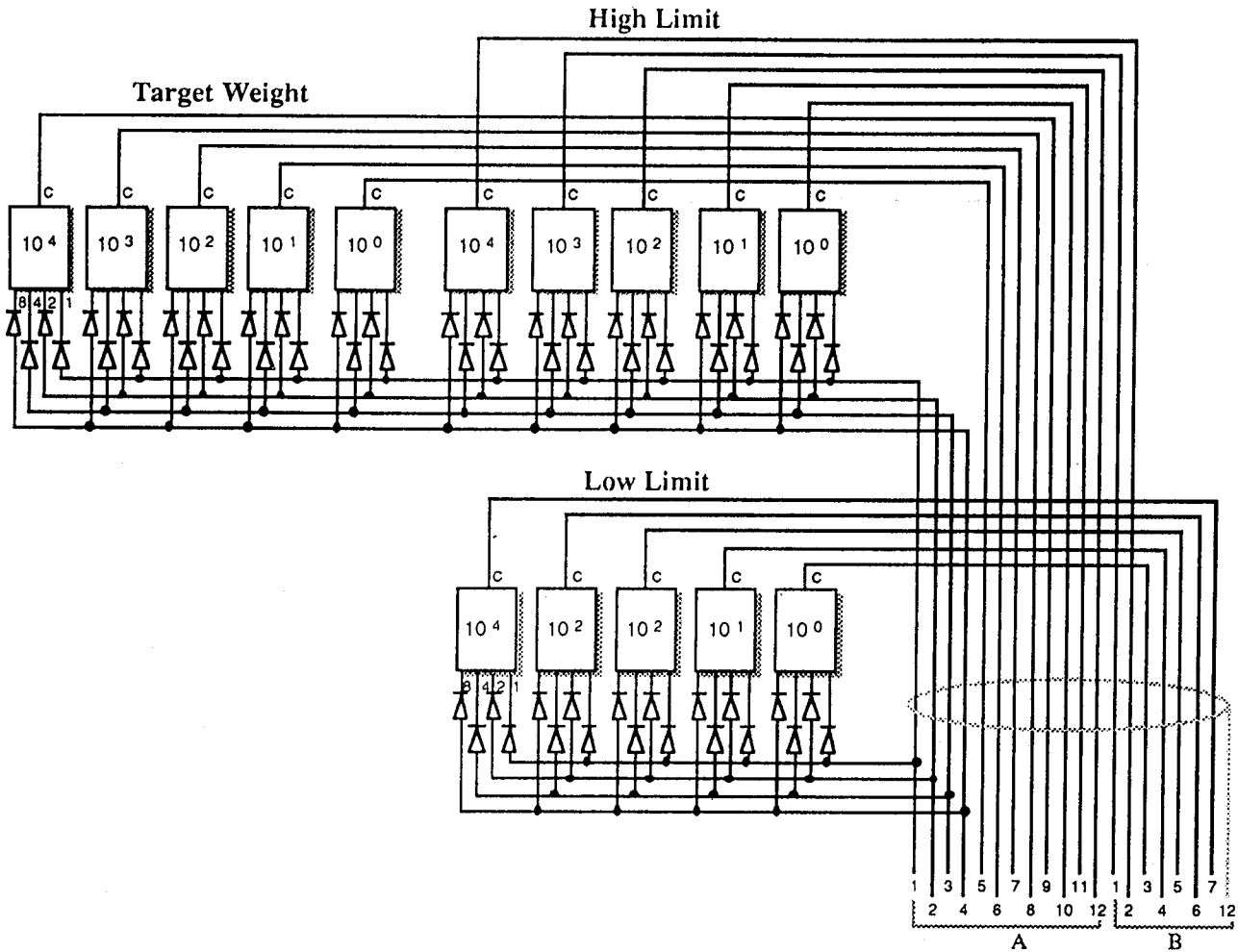

Pin	Signal	Pin	Signal
A-1	1	B-1	High Limit 10 ³ Common
A-2	2	B-2	High Limit 10 ⁴ Common
A-3	4	B-3	Low Limit 10 ⁰ Common
A-4	8	B-4	Low Limit 10 ¹ Common
A-5	Target Weight 10 ⁰ Common	B-5	Low Limit 10 ² Common
A-6	Target Weight 10 ¹ Common	B-6	Low Limit 10 ³ Common
A-7	Target Weight 10 ² Common	B-7	Low Limit 10 ⁴ Common
A-8	Target Weight 10 ³ Common	B-8	
A-9	Target Weight 10 ⁴ Common	B-9	
A-10	High Limit 10 ⁰ Common	B-10	
A-11	High Limit 10 ¹ Common	B-11	Internal Use
A-12	High Limit 10 ² Common	B-12	Shield (SHD)

■ **Comparison Mode 2**

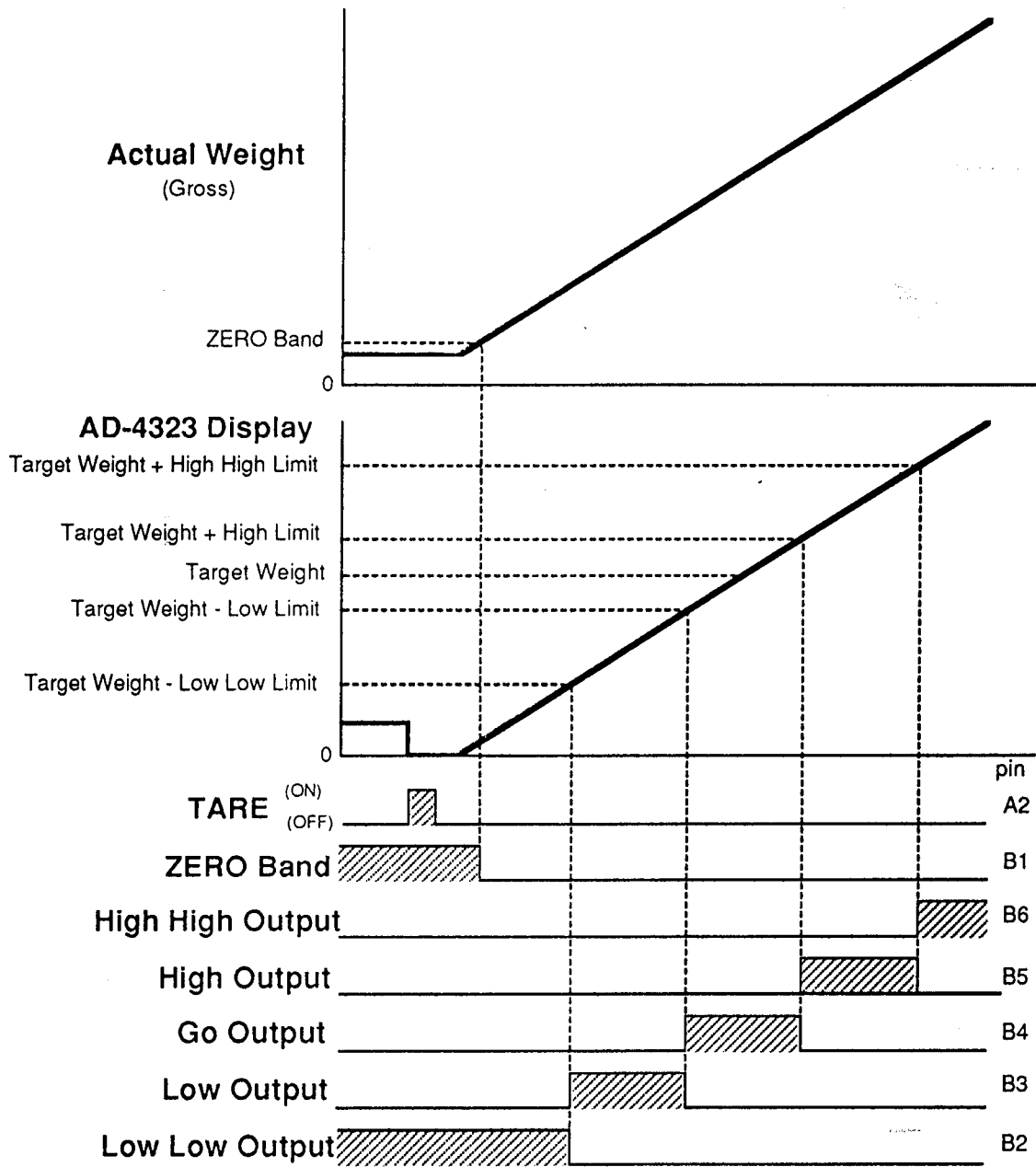

SETPOINT INTERFACE CHECK COMPARISON MODE 3

Used when F-70 is set at "1"
and F-15 is set at "3"
CHECK WEIGHING MODE

■ *Push Button Thumbwheels*

The following groups of thumbwheel switches can be directly interfaced:

- (a) High Limit (5 digits) (b) Low Limit (5 digits)
- If Min. Division is ≥ 10 : then (a) and (b) will be multiplied by ten before the Comparator compares the data.
- The Least Significant Digit (LSD) of a thumbwheel switch group corresponds to the LSD of the weight display.

■ *Setpoint Condition*

Output closes under the following conditions:

- | | |
|--|---|
| <ul style="list-style-type: none"> <input type="checkbox"/> <u>Output</u> ZERO Band Output High High Output High Output Go Output Low Output Low Low Output | <ul style="list-style-type: none"> <input type="checkbox"/> <u>Condition</u> "Gross Weight" < "ZERO Band". "Net weight" > "High High Limit". "Net weight" > "High Limit". "Low Limit" \leq "Net weight \leq "High Limit". "Net Weight" < "Low Limit". "Net Weight" < "Low Low Limit". |
|--|---|

■ *Pin Numbers*

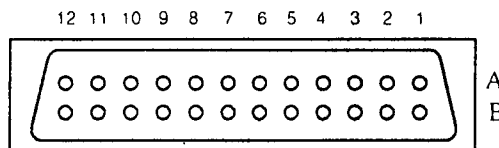

Attention

- The Input cable should be no longer than 20 inches (50cm max.).
- The "High High Limit" and "Low Low Limit" are set by F-Functions. See F-61 and F-64 page 47.

■ Setpoint Wiring Diagram and Input Pins

Used when F-70 is set at "1"
and F-15 is set at "3"
CHECK WEIGHING MODE

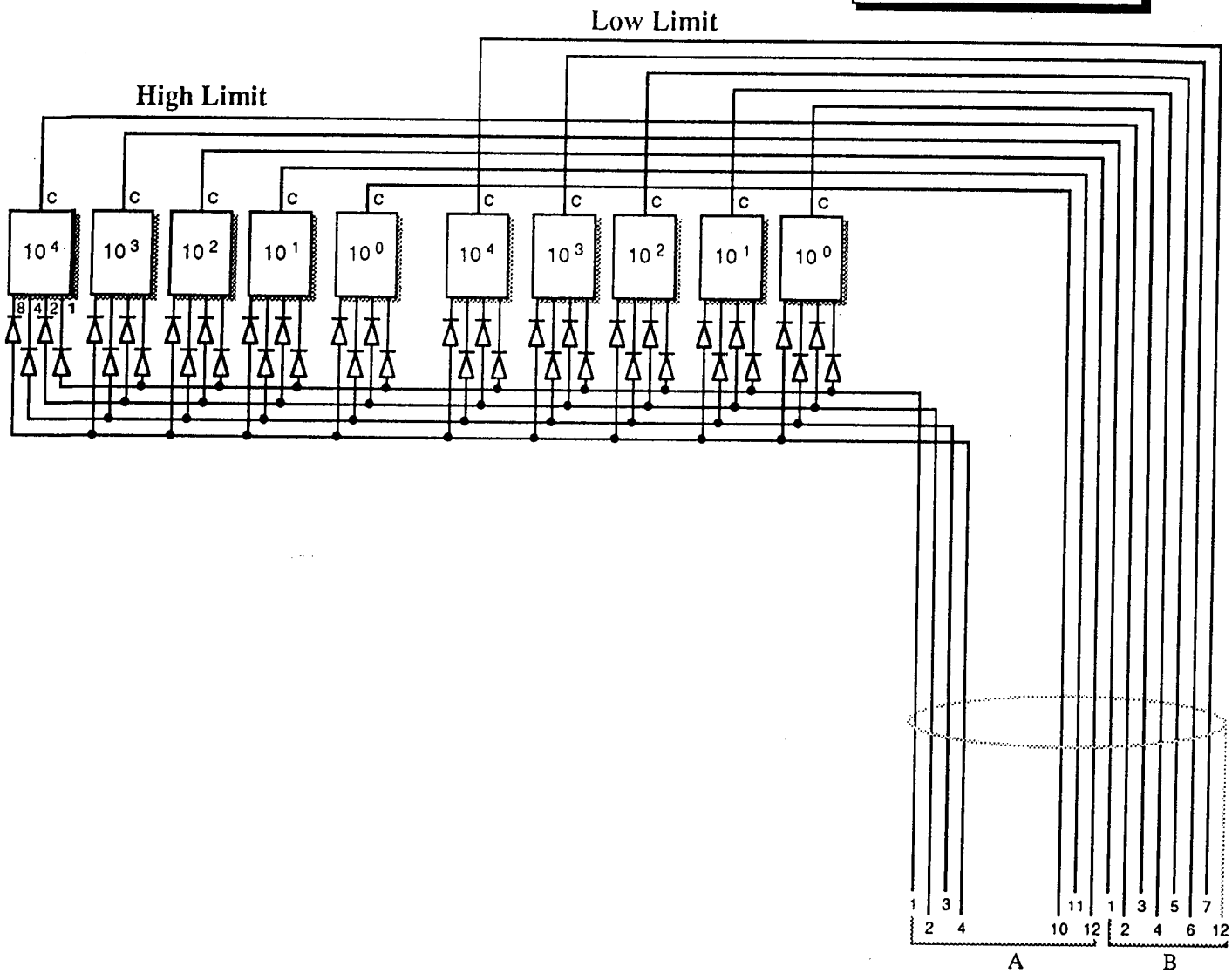

Pin	Signal	Pin	Signal
A-1	1	B-1	High Limit 10 ³ Common
A-2	2	B-2	High Limit 10 ⁴ Common
A-3	4	B-3	Low Limit 10 ⁰ Common
A-4	8	B-4	Low Limit 10 ¹ Common
A-5		B-5	Low Limit 10 ² Common
A-6		B-6	Low Limit 10 ³ Common
A-7		B-7	Low Limit 10 ⁴ Common
A-8		B-8	
A-9		B-9	
A-10	High Limit 10 ⁰ Common	B-10	
A-11	High Limit 10 ¹ Common	B-11	Internal Use
A-12	High Limit 10 ² Common	B-12	Shield (SHD)

■ **Comparison Mode 3**

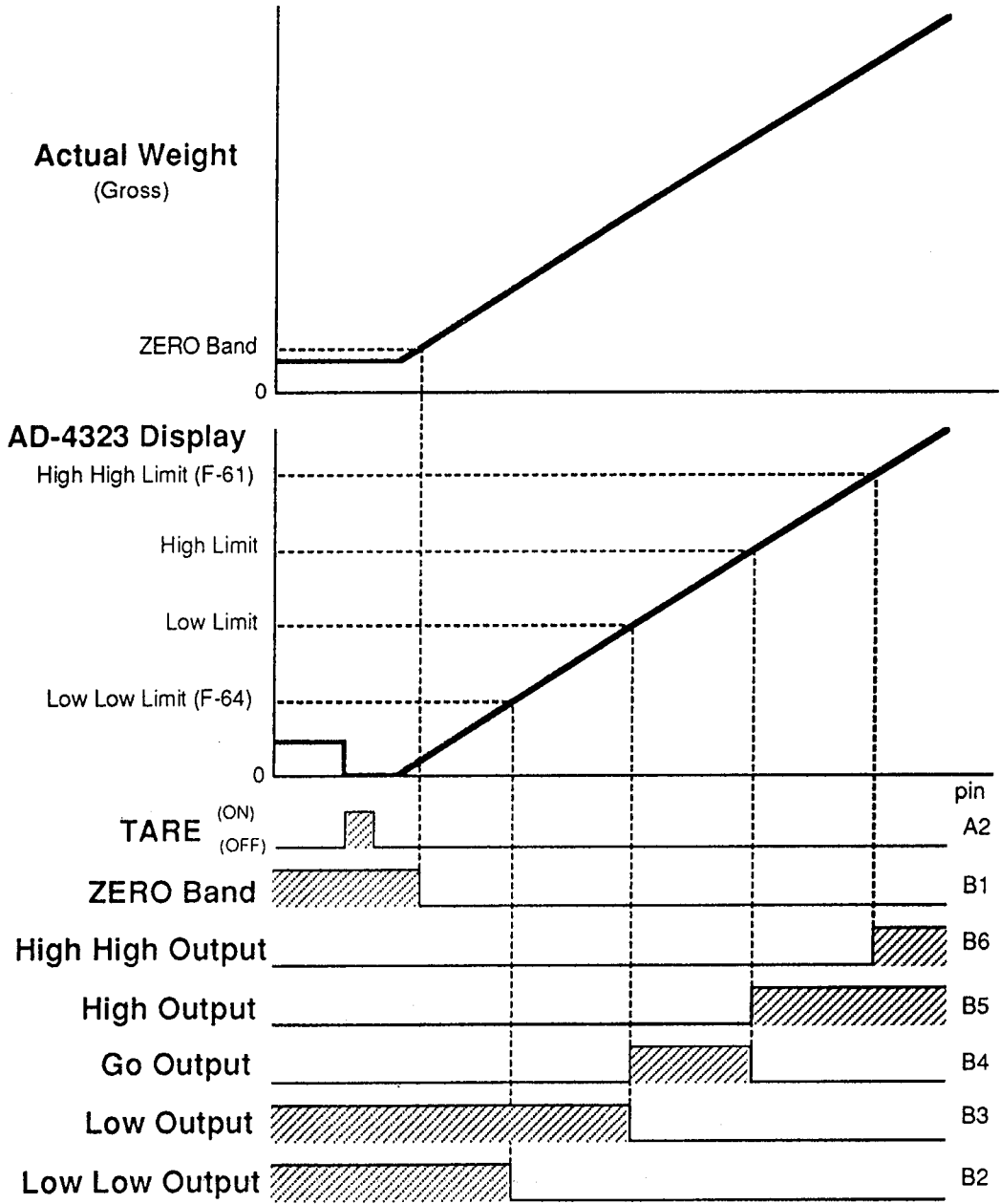

SETPOINT INTERFACE CHECK COMPARISON MODE 4

Used when F-70 is set at "1"
and F-15 is set at "4"
CHECK WEIGHING MODE

■ *Push Button Thumbwheels*

The following groups of thumbwheel switches can be directly interfaced:

- | | |
|--------------------------------|------------------------------|
| (a) High High Limit (4 digits) | (b) High Limit (4 digits) |
| (c) Low Limit (4 digits) | (d) Low Low Limit (4 digits) |
- If Min. Division is ≥ 10 : then (a), (b), (c), and (d) will be multiplied by ten before the Comparator compares the data.
 - The Least Significant Digit (LSD) of a thumbwheel switch group corresponds to the LSD of the weight display.

■ *Setpoint Condition*

Output closes under the following conditions:

- | <input type="checkbox"/> <u>Output</u> | <input type="checkbox"/> <u>Condition</u> |
|--|--|
| ZERO Band Output | "Gross Weight" < "ZERO Band". |
| High High Output | "Net weight" \geq "High High Limit". |
| High Output | "High Limit" \leq "Net Weight" \leq "High High Limit". |
| Go Output | "Low Limit" \leq "Net Weight" \leq "High Limit". |
| Low Output | "Low Low Limit" \leq "Net Weight" < "Low Limit". |
| Low Low Output | "Net Weight" < "Low Low Limit". |

■ *Pin Numbers*

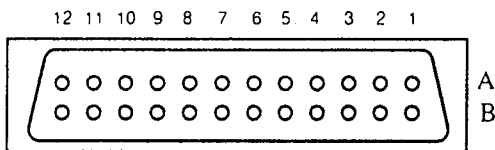

Attention

- The Input cable should be no longer than 20 inches (50cm max.).
- The "High High Limit" and "Low Low Limit" are set by F-Functions. See F-61 and F-64 page 47.

Setpoint Wiring Diagram and Input Pins

Used when F-70 is set at "1"
and F-15 is set at "4"
CHECK WEIGHING MODE

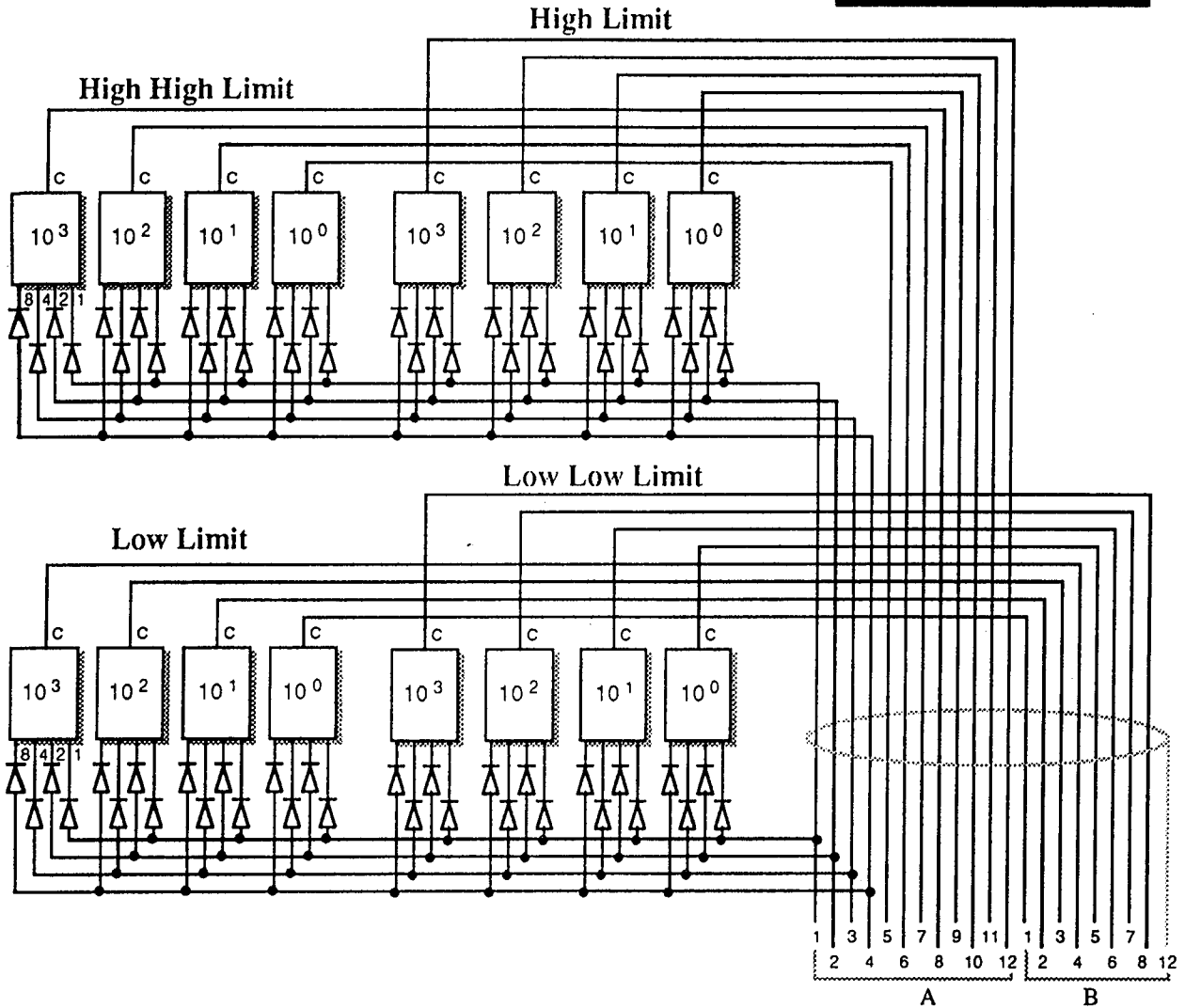

Pin	Signal	Pin	Signal
A-1	1	B-1	Low Limit 10 ⁰ Common
A-2	2	B-2	Low Limit 10 ¹ Common
A-3	4	B-3	Low Limit 10 ² Common
A-4	8	B-4	Low Limit 10 ³ Common
A-5	High High Limit 10 ⁰ Common	B-5	Low Low Limit 10 ⁰ Common
A-6	High High Limit 10 ¹ Common	B-6	Low Low Limit 10 ¹ Common
A-7	High High Limit 10 ² Common	B-7	Low Low Limit 10 ² Common
A-8	High High Limit 10 ³ Common	B-8	Low Low Limit 10 ³ Common
A-9	High Limit 10 ⁰ Common	B-9	
A-10	High Limit 10 ¹ Common	B-10	
A-11	High Limit 10 ² Common	B-11	Internal Use
A-12	High Limit 10 ³ Common	B-12	Shield (SHD)

■ **Comparison Mode 4**

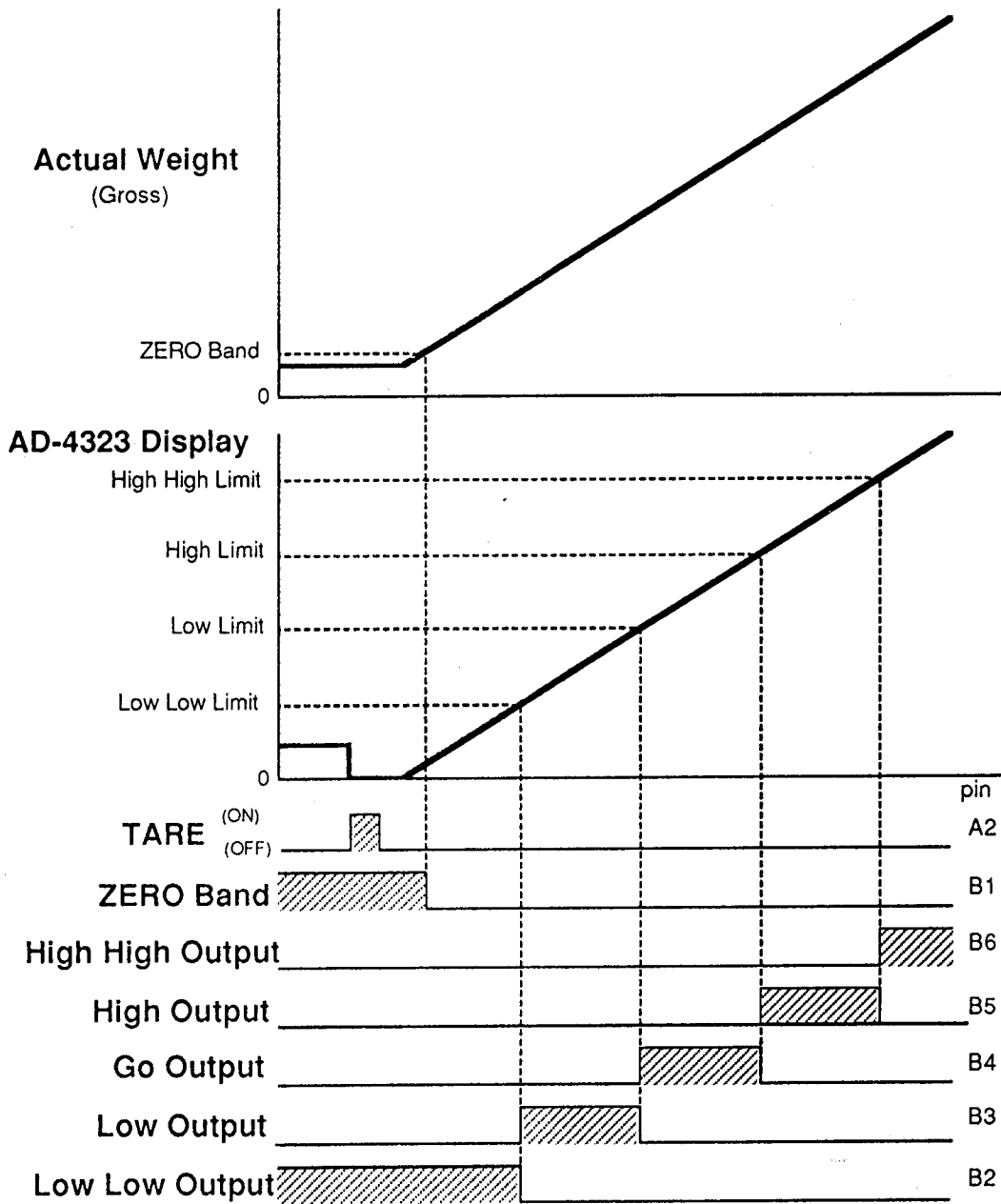

SETPOINT INTERFACE CHECK COMPARISON MODE 5

Used when F-70 is set at "1"
and F-15 is set at "5"
CHECK WEIGHING MODE

■ Setpoint Condition

Output closes under the following conditions, set by F-Functions **F-61** → **F-64**:

<input type="checkbox"/> Output	<input type="checkbox"/> Condition
ZERO Band Output	"Gross Weight" < "ZERO Band".
High High Output	"Net weight" ≥ "High High Limit".
High Output	"High Limit" ≤ "Net weight" < "High High Limit".
Go Output	"Low Limit" ≤ "Net Weight" < "High Limit".
Low Output	"Low Low Limit" ≤ "Net Weight" < "Low Limit".
Low Low Output	"Net Weight" < "Low Low Limit".

■ Comparison Mode 5

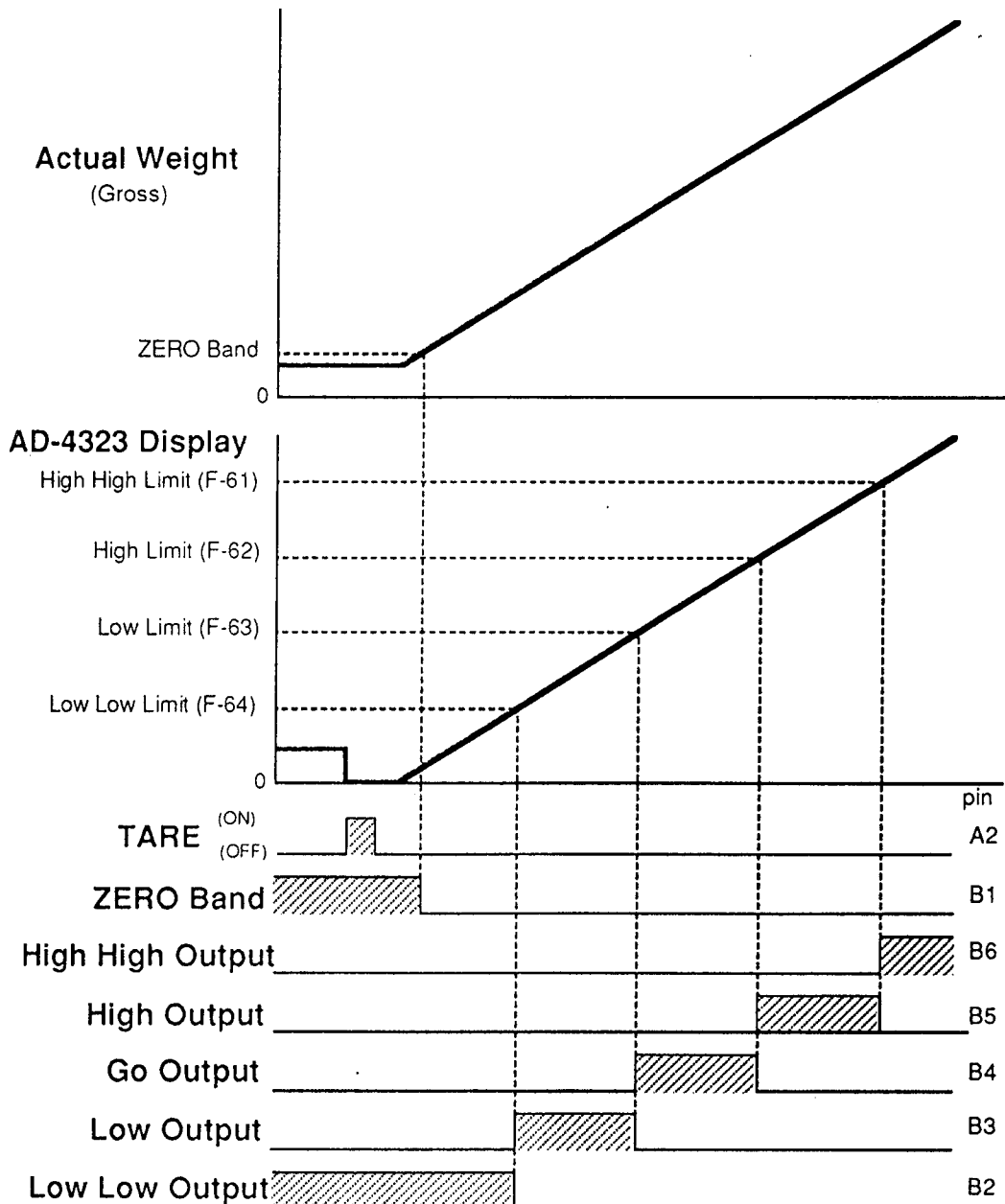

SET WEIGHT VALUE VIEW MODE

Connect the Load Cell(s) and remove any weight before entering this check mode.

Step 1.

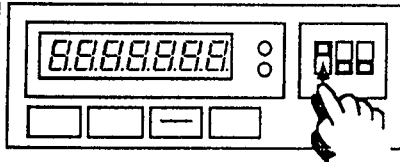

•Slide the left dip-switch (check) ON↑.
The display will come ON with a full display.

(A)



The display will blank during a **RAM** check, followed by;

Used when F-70 is set at "0"
BATCH WEIGHING MODE



(B)

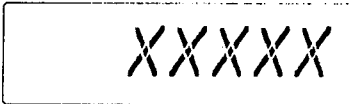

❶ The **Setpoint FINAL Value** will be displayed ("XXXXX" here denotes the value), followed by;

- ❷ The **Setpoint FREE FALL Value** will be displayed, followed by;
- ❸ The **Setpoint PRELIM Value** will be displayed, followed by;
- ❹ The **Setpoint HIGH Value** will be displayed, followed by;
- ❺ The **Setpoint LOW Value** will be displayed, followed by;

Used when F-70 is set at "1"
CHECK WEIGHING MODE



(B)

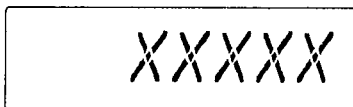

❶ The **TARGET WEIGHT Value** will be displayed ("XXXXX" here denotes the value), followed by;

- ❷ The **HIGH LIMIT Value** will be displayed, followed by;
- ❸ The **LOW LIMIT Value** will be displayed, followed by;
- Please note that the **HIGH HIGH LIMIT** value and the **LOW LOW LIMIT** value will not be displayed as they can only be set by F-Function (F-61, F-64).

(C)

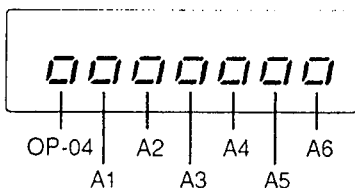

Either if no connection, or if a connection with the CONTROL I/O, or OP-04, will be displayed, followed by;

Step 2.

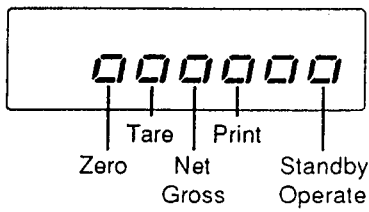

A **I** will appear when the front panel switches are pressed indicating a good switch. •Press each key in turn, if the display does not change, then the key switch is bad.

Step 3.

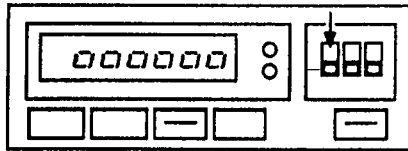

•Slide the left dip-switch (check) OFF↓.

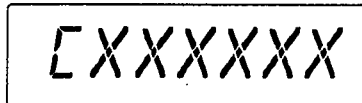

The internal A/D SPAN value will be shown, followed by;



"End" will be displayed for a couple of seconds, and then the display will return to normal.

STANDARD SERIAL OUTPUT

The Serial Output Connector is for a printer, score board, or similar device. Please refer to the following F-Functions for settings:

For Standard Current Loop

F 21	Baud Rate	600, 2400 Baud.
F 22	Output Data	Display, GROSS, NET, Tare or Gross+Net+Tare Data.
F 23	Output Mode	Stream, Auto Print, Print Key
F 24	Output Availability	Always Available, or Stable Only.

■ Stream Mode:

In this mode data will be transmitted whenever new data becomes available. However, the sampling rate is so fast that there is a possibility the output will not be the latest data - that this case the output wave form is:

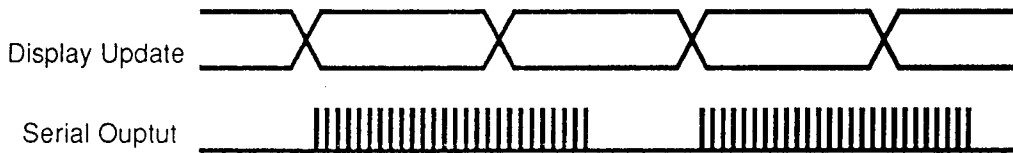

■ Auto Print Mode:

- Customer Program Control Modes:** The data is sent once when the Optional Prelim., Prelim., and Final have all been reached (ON) and the display is stable. The Auto Print function will reset if the net-weight data falls below +5D.
- Built-in Automatic Program Control Modes:** The data is sent when the (batch) Finish signal is sent.

■ Manual Mode:

The data is sent when I/O control A6 pin is shorted to the common or **PRINT** key is pushed.

■ Pin Assignment:

Pin	Assignment
1	N. C.
2	Frame Ground (GND)
3	Serial Output *
4	N. C.
5	Serial Output *
6	N. C.
7	N. C.

Connector: TCS 0270

*Output has no polarity -- bi-directional

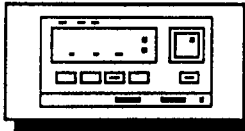

AD-4323 Weighing Indicator

Options

PARALLEL BCD OUTPUT Option OP-01

The Parallel BCD Output Connector is for sending weight data to a printer, score board, PLC (Programmed Logic Control). Please refer to the following F-Functions:

■ Transmission Mode:

The following formats and modes are selected by F-Functions:

F 31	Output Data	Display, GROSS, NET, or Tare Data.
F 32	Output Mode	Stream, Auto Print, PRINT Key.
F 33	Output Logic	Positive Logic, Negative Logic.

■ Pin Assignment:

Pin	Signal	Pin	Signal
1	Ground (GND)	26	Hi = Net Lo = Gross
2	1×10^0	27	N. C.
3	2×10^0	28	N. C.
4	4×10^0	29	N. C.
5	8×10^0	30	Internally Used
6	1×10^1	31	N. C.
7	2×10^1	32	N. C.
8	4×10^1	33	Lo = Motion Detection
9	8×10^1	34	Lo = kg Mode
10	1×10^2	35	Lo = kg Mode
11	2×10^2	36	Lo = kg Mode
12	4×10^2	37	Hi Permanently
13	8×10^2	38	Lo = kg Mode
14	1×10^3	39	Hi Permanently
15	2×10^3	40	Lo Permanently
16	4×10^3	41	Lo = kg Mode
17	8×10^3	42	Lo = Negative Polarity
18	1×10^4	43	Decimal Point at 10^{-1}
19	2×10^4	44	Decimal Point at 10^{-2}
20	4×10^4	45	Decimal Point at 10^{-3}
21	8×10^4	46	Decimal Point at 10^{-4}
22	1×10^5	47	Overload
23	2×10^5	48	N. C.
24	4×10^5	49	Data Valid Trigger
25	8×10^5	50	Hold (input)

□ 50 pin connector, TTL Open-Collector Output, fan-out 5, positive/negative

logic. Pins 2 → 25 are data output.

- When HOLD (pin 50) input is accepted by Open-Collector Output or contact closure, output will go to hold.
- Standard Accessory..... Mating connector (1) 57-30500 (Amphenol).

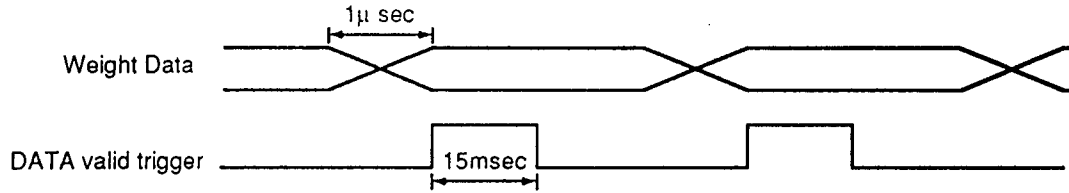

BCD Output Circuit:

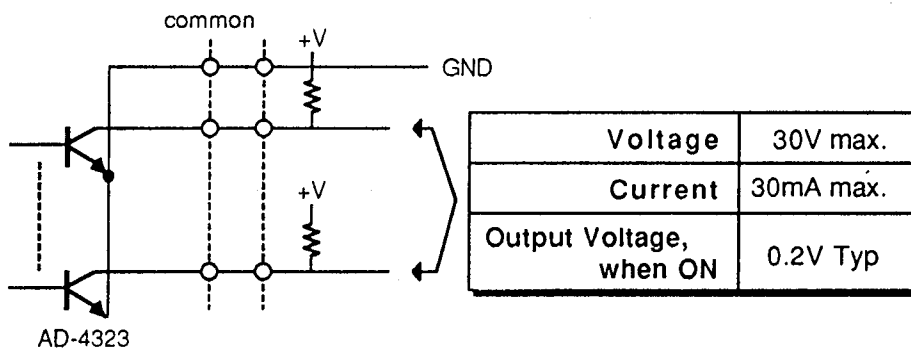

- The output circuit is an open-collector type. If you hook-up this line to TTL Logic, please add a pull-up resistor.

RS-232C INTERFACE Option OP-04

Attention



□ The analogue output from Load Cells, and the RS-232C input/output signals, are sensitive to electrical noise. Do not bind these cables together as it could result in cross-talk interference. Please also keep them well away from AC power cables. Keep all cable/coax as short as possible.

■ **Transmission Mode:**

The following formats and modes are selected by F-Functions:

□ For Serial Interface Option OP-04

F 41	Baud Rate	600, 1200, 2400, 4800*, 9600*.
F 42	Output Data	Display, GROSS, NET, Tare Data or Gross+Net+Tare Data. High Speed Output.
F 43 #1,#2.	Output Mode	Stream, Auto Print, Print Key, Command
F 44	Output Availability	Always Available, Only when Stable

* Not for use with Current Loop Output

■ **Signal Format**

Type EIA-RS-232C/Passive 20mA Current Loop.
Method Half-duplex, Asynchronous Transmission, Bi-directional.
Format Baud rate: 600, 1200, 2400, 4800 and 9600 selectable.
 Data bit: 7 Stop bit: 1
 Parity bit: 1 Even Code: ASCII

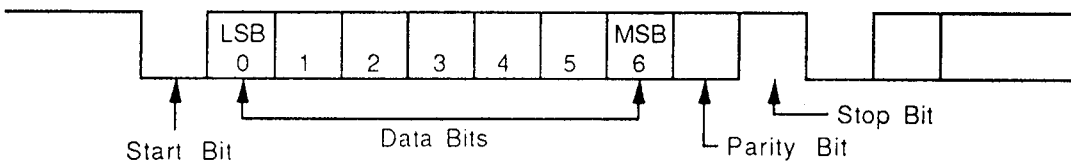

RS-232C	20mA Cur. Loop
1 = -5V → -15V	20mA
0 = +5V → +15V	0mA

■ **Stream Mode:**

The Stream Mode is available for both RS-232C and 20mA Current Loop. In this mode data will be transmitted whenever new data becomes available, without receiving any input.

■ Data Format:

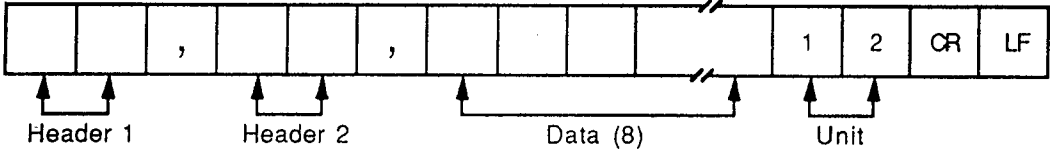

- **Header 1:**
 - OL - Overload, Underload
 - ST - Display is Stable (no motion)
 - US - Display is Unstable (in-motion)
- **Header 2:**
 - NT - NET Mode
 - GS - GROSS Mode
 - TR - TARE Data
- **Weight Data TXD by ASCII numerals plus:**
 - 2D (HEX) "-" (minus)
 - 2B (HEX) "+" (plus)
 - 20 (HEX) " " (space)
 - 2E (HEX) "." (decimal point)
- **Unit 1:**
 - kg = 67 (HEX)
 - t = 20 (HEX)
 - lb = 6C (HEX)
- **Unit 2:**
 - kg = 6B (HEX)
 - t = 74 (HEX)
 - lb = 62 (HEX)

■ Command Mode #1:

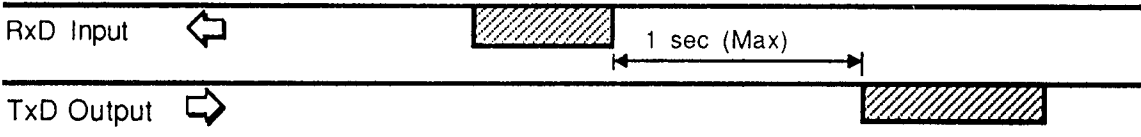

To AD-4323	Command Explanation	AD-4323 Response
R \langle LF •READ•	This is a command to the AD-4323 to read the data and transmit.	If "R" is received, the AD-4323 will send the latest data one time.
Z \langle LF •ZERO•	This is a command to the AD-4323 to ZERO the display.	If "Z" is received, the AD-4323 display will ZERO and: Z \langle LF will be sent by the AD-4323.
T \langle LF •TARE•	This is a command to the AD-4323 to TARE the display and go to NET mode.	If "T" is received, AD-4323 will go to NET mode, display will ZERO, TARE ENTERED annunciator will light and: T \langle LF will be sent by the AD-4323.
N \langle LF •NET•	This is a command to the AD-4323 to change from GROSS to NET mode.	If "N" is received, AD-4323 display will change from GROSS to NET mode and: N \langle LF will be sent by the AD-4323.
G \langle LF •GROSS•	This is a command to the AD-4323 to change from NET to GROSS mode.	If "G" is received, AD-4323 display will change from NET to GROSS mode and: G \langle LF will be sent by the AD-4323.

■ RS-232C "S" Setpoint Command #2:

Used when F-70 is set at "0"
 BATCH WEIGHING MODE 

In addition to Commands "R,Z,T,N,G" there is an additional "S" command for Setpoint data. If option OP-05 has setpoint value, they will over-ride the AD-4323's. OP-05 data should be set at "00000", or you must disconnect the cable.

Each setpoint value has six digits followed by carriage return <CR> & Line Feed <LF>. There are no decimal points or separator.

Final (6 digits)	Free Fall (6 digits)	Prelim. (6 digits)	Over (6 digits)	Under (6 digits)	Op-Prelim. (6 digits)	Zero Band (6 digits)	CR (1 digit)	LF (1 digit)
---------------------	-------------------------	-----------------------	--------------------	---------------------	--------------------------	-------------------------	-----------------	-----------------

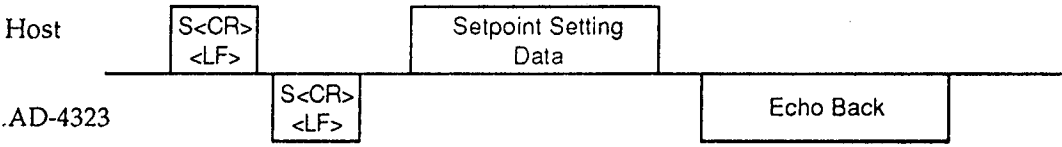

- F-43 should be set at "5".
- If F-15 is set at "1" or "2", then External I/O pin A4 should be open.

00200000010000020000003000002000100000050 CR LF

Example: Final (200.0) Free Fall (10.0) Prelim. (20.0) Over (3.0) Under (2.0) Op-Prelim. (100.0) Zero (5.0)

- If the commands are not accepted for any reason: I ^{CR} LF will be sent by the AD-4323.
- If an invalid character is received: ? ^{CR} LF will be sent by the AD-4323.

Used when F-70 is set at "1"
 CHECK WEIGHING MODE 

Target* Weight (6 digits)	High High Limits (6 digits)	High Limits (6 digits)	Low Limits (6 digits)	Low Low Limits (6 digits)	000000 (6 digits)	Zero Band (6 digits)	CR (1 digit)	LF (1 digit)
---------------------------------	-----------------------------------	------------------------------	-----------------------------	---------------------------------	----------------------	-------------------------	-----------------	-----------------

*If Target Weight is not used (F-15 = 3,4, or 5), then send "00000".

- F-43 should be set at "5".
- External I/O pin A4 should be shorted to common (A8).

00500000700000600000400000300000000000050 CR LF

Example: Target (500.0) High High (700.0) High (600.0) Low (400.0) Low Low (300.0) Zero (5.0)

- If the commands are not accepted for any reason: I ^{CR} LF will be sent by the AD-4323.
- If an invalid character is received: ? ^{CR} LF will be sent by the AD-4323.

High Speed Output:

If F-Function F-42 is set at either "6" or "7" (update rate = 70/sec), due to the high transmission rate, the following F-Function settings will be over-ridden: •F-41 to "5", 9600 BPS; •F-43 to "1", Stream; •F-44 to "1", Output Always Available. The data is sent in 7 digits (± 999999), no decimal points, units or over/under.

Data is sent in 7 digits, no decimal points

Example: 32.568kg

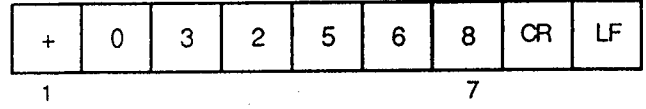
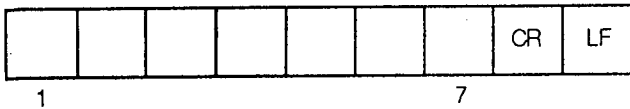

Printers and Other Devices:

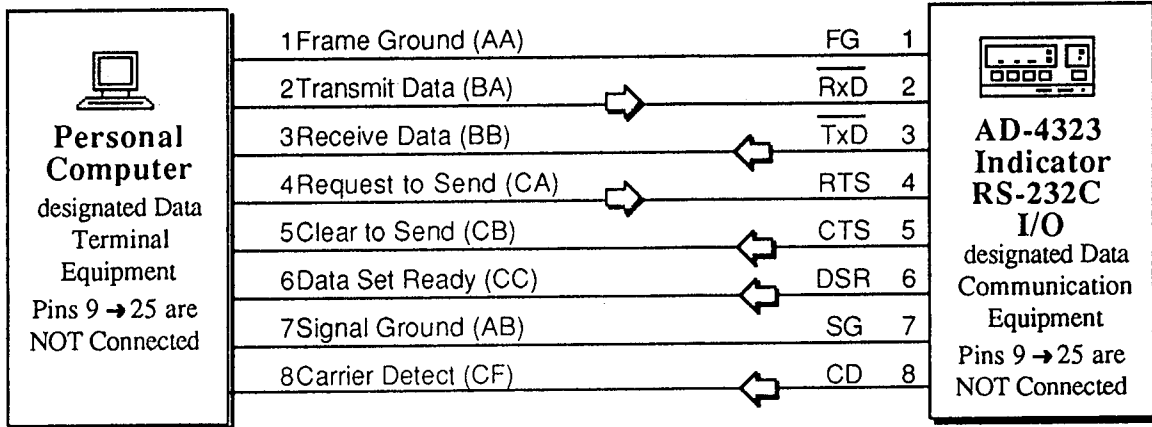

RS-232C Circuit:

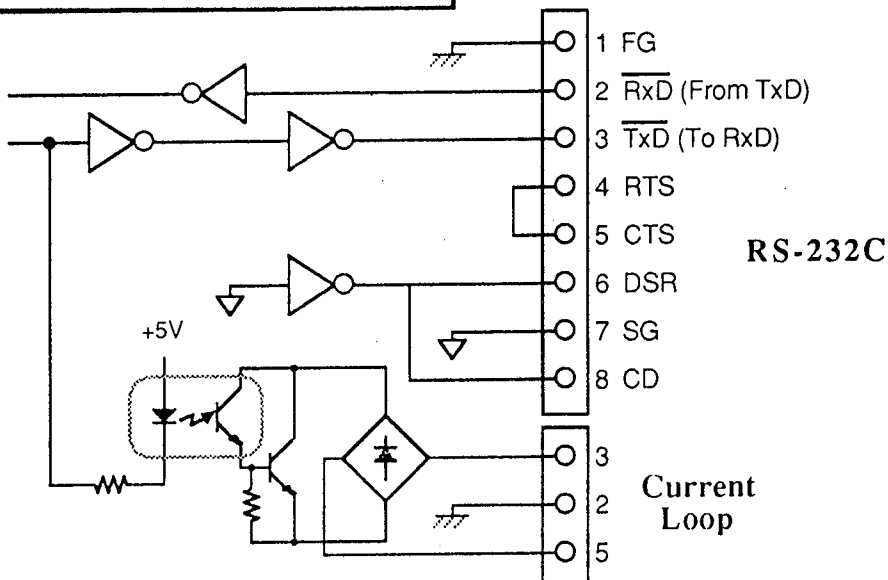

SETPOINT UNIT Option OP-05

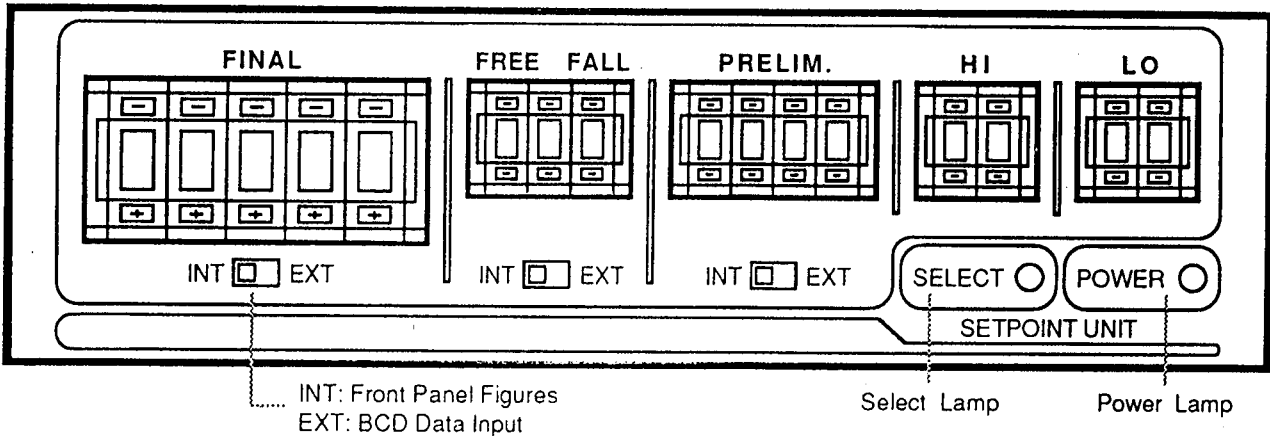

This is an independent unit housed in a separate metal case. It may be directly interfaced to any AD-4323 via attached cable and connector. This option will also accept external input signals - which means that it may be used to control multiple batching operations after receiving external setpoint information.

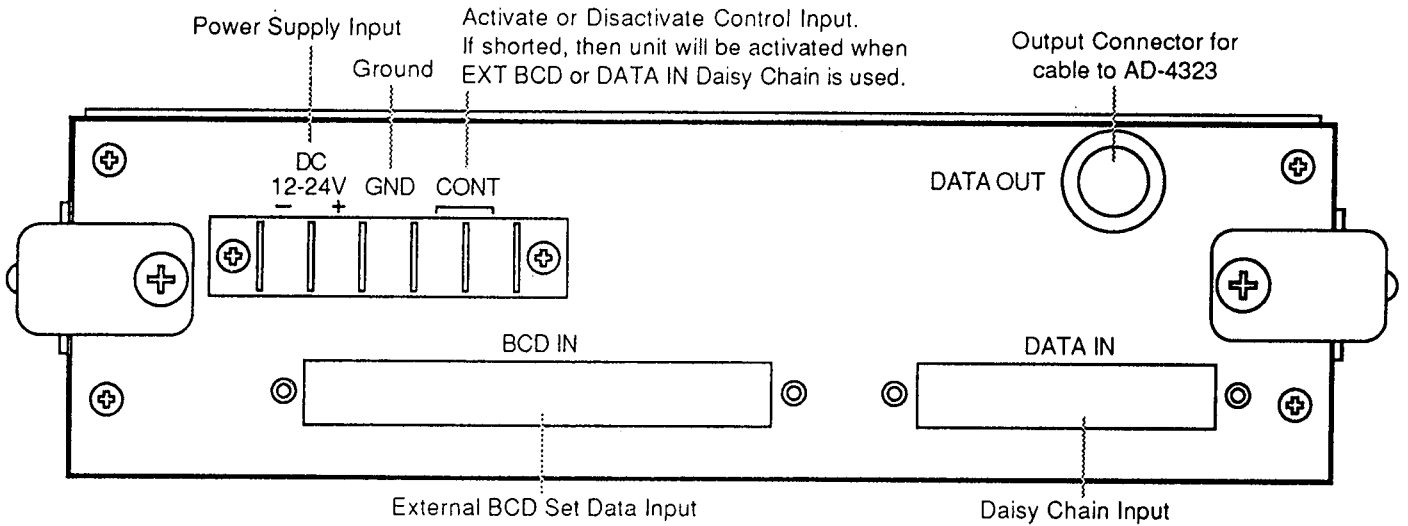

■ General Specifications:

Power Requirements	DC 11.5V →25V
Operating Temperature	23°F →104°F (-5°C →+40°C)
Operating Humidity	85% or less (non-condensing)
Net Weight	2.2 lb (1kg) Approximately
Physical Dimensions (inch)	7.6 wide x 4.6 depth x 2.2 height inches
Physical Dimensions (mm)	192 wide x 117 depth x 57 height mm
Panel cut-out Dimen. (inch)	7.13 wide(+0.04) x 2.087 height(+0.02) inches
Panel cut-out Dimen. (mm)	181 wide(+1.0) x 53 height(+0.5) mm
Interface cable	50cm (20 inches) includes a connector.

■ Input Data

Setpoint data may be programmed either via the front panel thumbwheels or through the external input facility.

Front Panel Thumbwheels

- | | | | |
|--------------------|------------|---------------|------------|
| (a) Final Weight | (5 digits) | (b) Free Fall | (3 digits) |
| (c) Prelim. Weight | (4 digits) | (d) Hi Limit | (2 digits) |
| (e) Lo Limit | (2 digits) | | |

External Input

- | | | | |
|--------------------|------------|---------------|------------|
| (a) Final Weight | (5 digits) | (b) Free Fall | (3 digits) |
| (c) Prelim. Weight | (4 digits) | | |

■ Connections:



When Option OP-05 is used in external input mode it must be provided with DC power. Power is not necessary for the front panel thumbwheels.

Setpoint Unit OP-05 and AD-4323 ONLY:

- If just this setpoint unit and AD-4323 are going to be used, external power is not needed.
- The front panel's internal/external (INT/EXT) switch should be switched to the INT side.

With External (EXT) BCD IN (input), or Daisychain:

- If you are going to use the setpoint unit with an external BCD IN, or with daisychained units, you will have to have to supply a DC 11.5~25V power supply.
- The setpoint unit will be activated by shorting the CONT terminal (rear panel).
- When the front panel INT/EXT switches are on the:
 - INT side: the settings which are entered by the thumbwheels are used.
 - EXT side: the settings which are entered by the external BCD line input (BCD IN) are used.

• EXAMPLE:

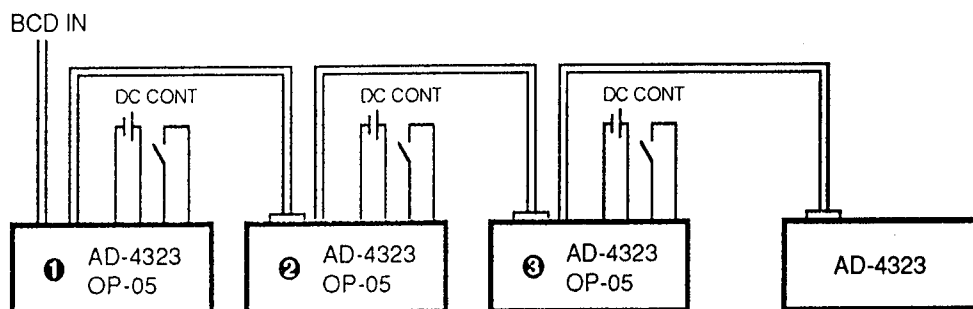

- If you shorten the CONT terminal of setpoint unit ②, then unit ② will be activated. The AD-4323 will get the data from unit ②.
- If you shorten the CONT terminal several units at a time, then the AD-4323 will select the setpoint unit nearest to the AD-4323.

Pin Assignment for EXT BCD Input:

Pin	Signal	Pin	Signal
A1	Ground (GND)	B1	1×10^1
A2	1×10^0	B2	2×10^1
A3	2×10^0	B3	4×10^1
A4	4×10^0	B4	8×10^1
A5	8×10^0	B5	1×10^2
A6	1×10^1	B6	2×10^2
A7	2×10^1	B7	4×10^2
A8	4×10^1	B8	8×10^2
A9	8×10^1	B9	1×10^0
A10	1×10^2	B10	2×10^0
A11	2×10^2	B11	4×10^0
A12	4×10^2	B12	8×10^0
A13	8×10^2	B13	1×10^1
A14	1×10^3	B14	2×10^1
A15	2×10^3	B15	4×10^1
A16	4×10^3	B16	8×10^1
A17	8×10^3	B17	1×10^2
A18	1×10^4	B18	2×10^2
A19	2×10^4	B19	4×10^2
A20	4×10^4	B20	8×10^2
A21	1×10^0	B21	1×10^3
A22	2×10^0	B22	2×10^3
A23	4×10^0	B23	4×10^3
A24	8×10^0	B24	8×10^3

Final

Free Fall

Prelim.

Free Fall

Fuse Replacement:

- To replace the fuse, please remove the top cover.
- There is a fuse located on the Printed Circuit Board.
- Fuse: F7142-0.3A
- Connector: FCN361J048-AG and FCN360C048-B-Fujitsu

■ **EXT BDC Input Signal:**

- The input signal has the following requirements:
 - The signal should be BCD data.
 - The Logic should be Negative.
 - The Input Interface should be Open-Collector output, or Dry-Relay Contact.
 - *The Interface circuit of AD-4323-05:*

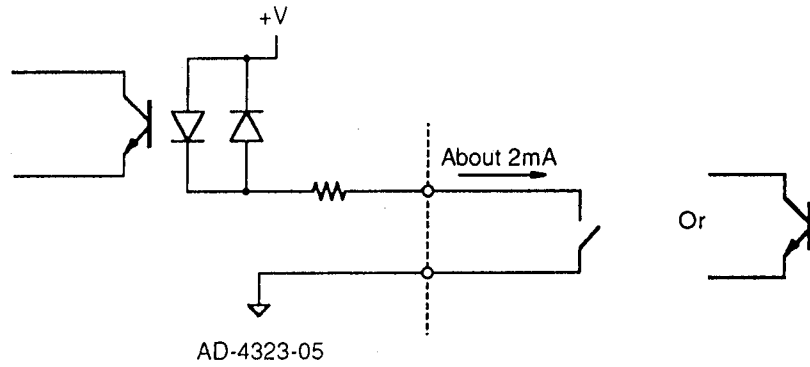

ANALOG OUTPUT Option OP-07

This option is used to transmit the Analog weight data to equipment that is controlled by Analog signal.

■ Transmission Mode:

The following formats and modes are selected by F-Functions:

For Analog Option OP-07

F 51	Analog Output Data	Display, Gross, or Net Data.
F 52	Output current at display ZERO	0.0mA through 99.9mA.
F 53	Output current at Full Scale	0.0mA through 99.9mA.

■ Specifications:

Output level	4~20mA effective range. Output range is approx. 2mA to 22mA.
Resolution	more than 1/1000.
Temperature Coefficient	$\pm(0.015\% \text{ of rdg} + 0.01\text{mA})/^{\circ}\text{C}$
Max. Load Resistor	500 Ω Max.

- The output current when the display is at "0", and at maximum capacity, can be set from 0.0mA to 99.9mA by F-Functions F-52 & F-53.
- If the output is NET output and the weighing mode is Loss-in-Weight mode, the Analog output will send the reversed value.
- For example, to convert current to voltage:

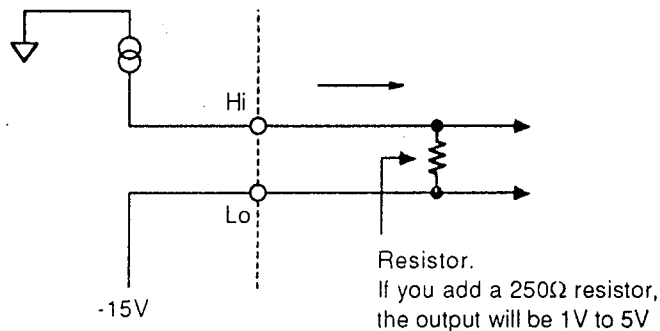

- Caution!!** This resistor must be high enough for the power consumption. If a 500 Ω resistor is used, power consumption will be:

$$W = i^2 R = (0.02)^2 \times 500 = 0.2(W).$$

W = power
 i = output current
 R = Resistor

It should be a 1/2W type resistor and have a very low temperature coefficient.

- Do not connect any GND line, body GND, or similar device.

■ Setting Output Current:

Output Current can be scaled from ZERO to Full Capacity by F-Functions F-52 and F-53. The setting range is 0.0mA to 99.9mA, by steps of 0.1mA. This simulated value is calculated by the following formula:

$$I_{OUT} = I_z + \frac{\text{weight}}{\text{capacity}} \times (I_M - I_z) \quad (\text{if } 2\text{mA} \leq I_{OUT} \leq 22\text{mA})$$

I_{OUT} = Current
 I_z = Output at Zero
 I_M = Output at Max. Capacity

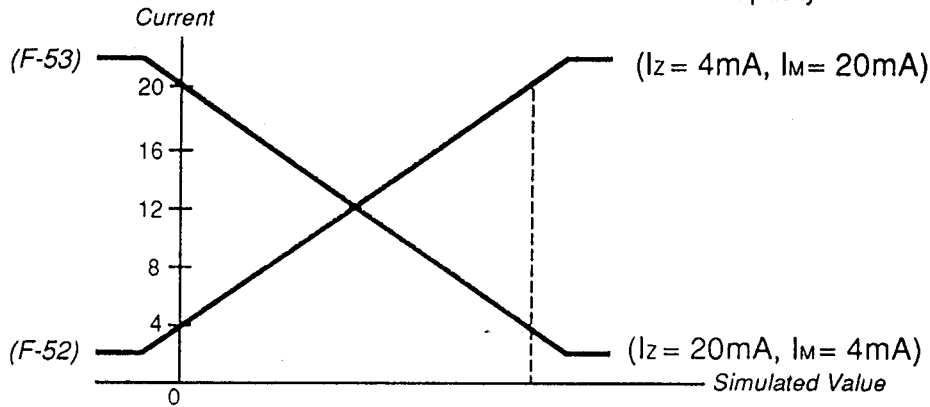

Example:

A weighing system has a Max. Capacity of 10,000kg. If you want the current to be 4mA at ZERO display, and 20mA at 1/2 capacity then:

$$I_M = \frac{\text{capacity}}{\text{simulated value}} \times (I_{OUT} - I_z) + I_z$$

$$I_M = \frac{10,000\text{kg}}{5,000\text{kg}} \times (20\text{mA} - 4\text{mA}) + 4\text{mA}$$

$$= 36\text{mA}$$

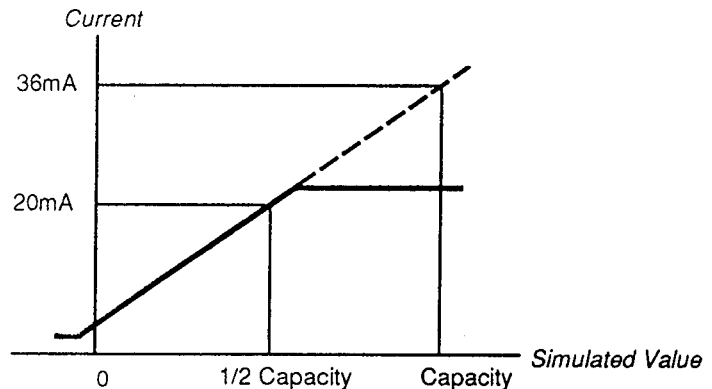

When OUTPUT CURRENT AT FULL SCALE (F-53) is set at 36mA, and OUTPUT CURRENT AT DISPLAY ZERO (F-52) is set at 4mA, then at 1/2 capacity (5,000kg) the output current will be 20mA. NOTE: The maximum output will be saturated at 22mA.

□ Accessory: BNC type plug: BNC-P-58U.

■ Analog Connector:

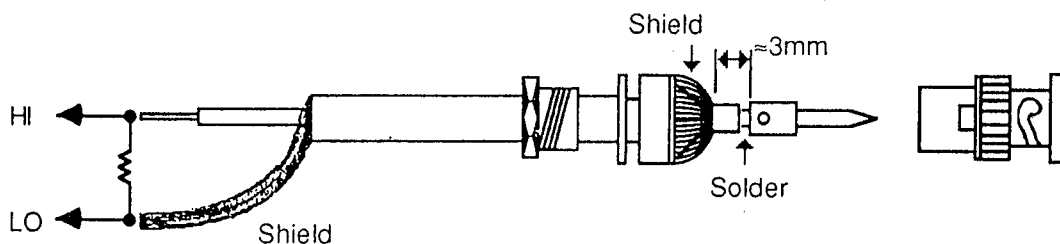

DIMENSIONS

AD-4323/Weighing Indicator

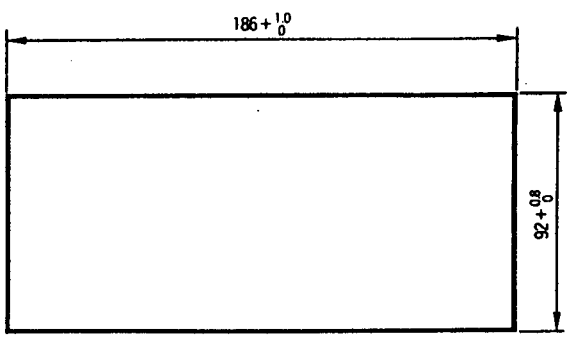
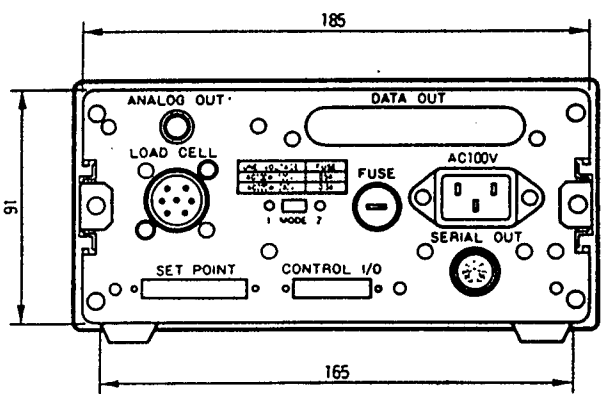
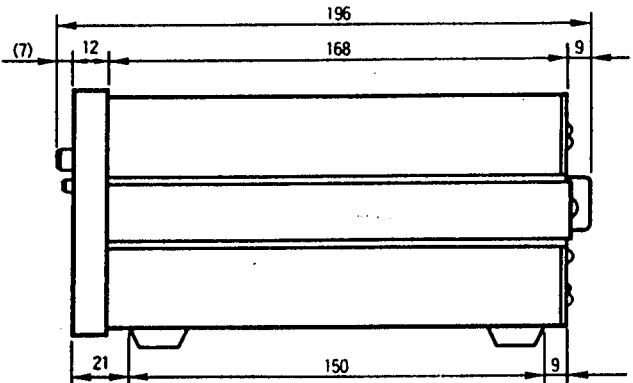
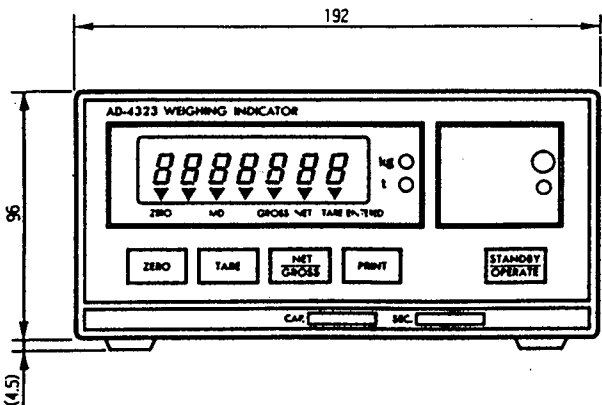

Optional Setpoint Unit (OP-05)

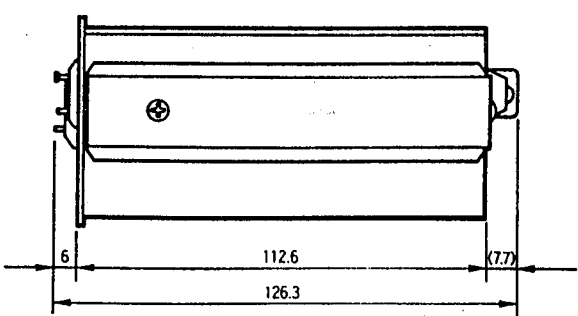
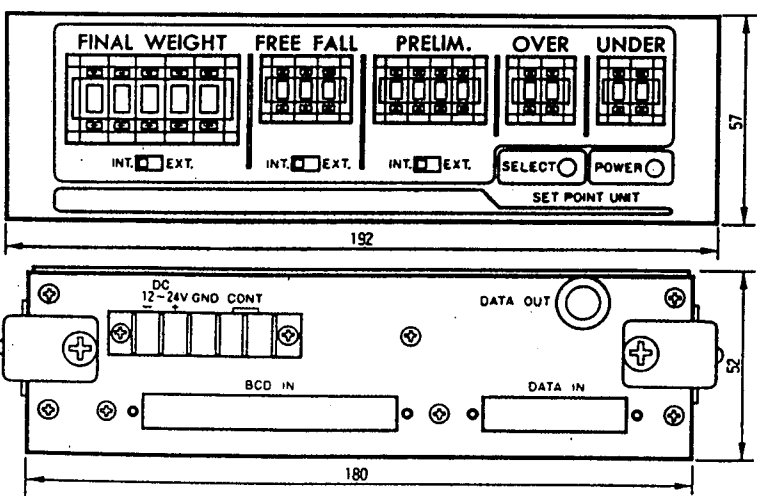

AND

A&D Company, Limited

3-23-14 Higashi-Ikebukuro, Toshima-ku, Tokyo 170 JAPAN
Telephone: [81] (03) 5391-6132 Fax: [81] (03) 5391-6148

A&D ENGINEERING, INC.

1555 McCandless Drive, Milpitas, CA. 95035 U.S.A.
Telephone: [1] (408) 263-5333 Fax: [1] (408) 263-0119

A&D INSTRUMENTS LTD.

Abingdon Science Park, Abingdon, Oxford OX14 3YS ENGLAND
Telephone: [44] (0235) 550420 Fax: [44] (0235) 550485

< German Sales Office >

Genfer Strasse 6, Niedereschbach 60437 Frankfurt Main 50 GERMANY
Telephone: [49] (069) 507-1017 Fax: [49] (069) 507-2054

A&D MERCURY PTY. LTD.

32 Dew Street, Thebarton, South Australia 5031 AUSTRALIA
Telephone: [61] (08) 352-3033 Fax: [61] (08) 352-7409

A&D KOREA Limited

Seongmi Building 2/3F, 740-18 Panpo-1dong, Seocho-ku, Seoul, KOREA
Telephone: [82] (02) 517-4101 Fax: [82] (02) 546-4264