

CI200 SERIES

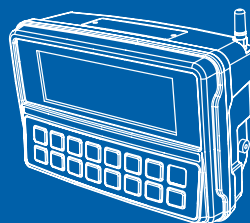

Weighing Indicator







Cautions for Your Safety

Please comply with 'Cautions for Your Safety', which will lead you to use the product safely and properly to prevent any dangerous situations.



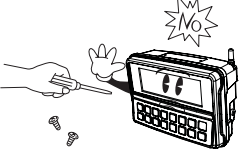
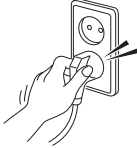

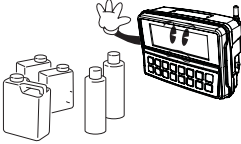
- Cautions are divided into 'Warning' and 'Alert', which mean as follows.
- Keep this manual in a place where product users can find out, after finish reading it.

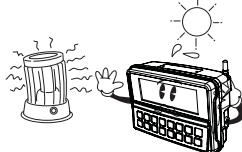
 Warning
'Warning' means a great possibility led to the death or heavy injury when instructions are violated.
 Attention
'Alert' means a great possibility led to the injury or material damage when instructions are violated.

⚠ Warning

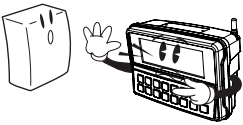
<p>Never disassemble, repair or retrofit the product. It might exclude the product from the quality assurance and cause the damage to devices, electric shock or fire.</p>	<p>Ensure the power plug to be fully inserted to prevent shaking. Any instable connection might cause electric sparks to set fire.</p>	<p>Ensure the grounding of the product. Poor grounding might cause failure or electric shock upon electric leak.</p>
		
<p>Do not damage, process, excessively jerk, bend or twist the power cord. It might damage the power cord to cause fire or electric shock.</p>	<p>Keep any combustible spray or fire source away. It might cause fire.</p>	<p>Do not spray water to the outside of the product or use it in any humid place. It might deteriorate the insulation of electric parts that can cause the electric shock, fire risk or weighing errors.</p>
		
<p>Do not place the product to the direct sunlight or near any hot object like a heater. It might cause fire.</p>		
		

 **Attention**

<p>Check the weighing error anytime for the accurate weighing. Any use out of the allowed tolerance for the careless use or other causes might not ensure the accurate weighing. Customer Service : 080-022-0022</p>	<p>Avoid any sudden shock to the product. It might damage the product to fail the accurate weighing.</p>	<p>Find a proper place to attach the rubber pad at the bottom of the indicator, which was shipped together.</p>
		
<p>Do not use the product at a place with sudden temperature changes or severe vibrations. It might cause the weighing error or failure.</p>	<p>Do not install the produce at a place with the excessive electromagnetic wave. It might cause the wrong weighing.</p>	
		

Contents

1. Features	9
1-1. Features	9
1-2. Major Functions	9
1-3. Analog and A/D Conversion	10
1-4. Digital and Display	10
1-5. General Specifications	11
1-6. Communication and Option	11
2. Specifications in Appearance	12
2-1. External Dimension	12
2-2. Front Panel Descriptions	14
2-3. Rear Panel Descriptions	20
3. How to Install	22
3-1. How to Connect Load Cell	22
4. Weight Setup Mode	23
4-1. Weight Setup Menu	23
4-2. How to Seal the Indicator	30
5. Set Mode	31
5-1. How to Enter the Set Mode	31
5-2. Descriptions on key operations in the Set Mode	31
5-3. Set Menu Descriptions (F00 ~ F82)	32
5-3-1. General Function	35
5-3-2. RS-232 (Serial Communication) Function	41
5-3-3. Print Function	46
5-3-4. Checker Function	51
5-3-5. Other Functions	52
6. Test Mode	53
6-1. How to Enter the Test Mode	53
6-2. Test Menu	53

7. System Mode	58
7-1. How to Enter the System Mode	58
7-2. PCS Mode	60
7-3. Percent Mode	62
8. General Function Descriptions	64
8-1. Item Number Input Method	64
8-2. Key Tare Input Method	64
8-3. How to Check Subtotal, Total and Weighing Count	65
8-4. How to Enter High Limit	66
8-5. How to Enter Low Limit	66
9. Weighing Mode	67
9-1. Zeroing Function – LED	67
9-2. Tare Function – LED	67
9-3.	68
9-4. Zeroing Function – LCD	69
9-5. Tare Function – LCD	69
9-6.	70
10. Charge and Use Time	71
10-1. How to Use and Charge the Chargeable Batter	71
10-2. Use Time of the Battery	71
11. RS-232C Interface in Detail	72
11-1. RS-232C Port Connection	72
11-2. How to Connect Serial Communication Devices	73
11-2-1. How to Connect an Auxiliary Display	73
11-2-2. How to Connect a Label Printer	73
11-3. RS-232 Communication Protocol	73
11-3-1. 22 Bytes for CAS	73
11-3-2. 10 Bytes for CAS	74
11-3-3. A18 Bytes for AND	74
12. Error Message	76
12-1. Error Message from the Weight Setup Mode	76
12-2. Error Message from the Weighing Mode	77

Preface

Thank you very much for purchasing CAS International Indicator.

This produce is characterized by the excellent performance and luxurious features through strict examinations, as well as elaboration for each part under our strict quality control.

CA Indicator (CI series) is a product with rich functions and various external interfaces, which is designed to comply well with special requirements in a variety of industrial fields under strong and beautiful designs in appearance.

In addition, it is designed for the user-friendly programs for the easier use of indicator by any user with the built-in message display functions to help users understand the product.

Please use the product right and sufficiently utilize functions of CI200 series as you read this manual thoroughly before using CI200 series.

1. Features

1-1. Features

<input type="checkbox"/> Suitable for the platform and bench type scale and weighing system
<input type="checkbox"/> Easy operations
<input type="checkbox"/> Simple and prompt full digital calibration (automatic weight setup at once)
<input type="checkbox"/> Weight backup functions [restoring weight at the power supply On/Off]
<input type="checkbox"/> Multiple weights setup functions [5 point input weight setup]
<input type="checkbox"/> Command mode functions [PC control functions - data request and setup]
<input type="checkbox"/> 6 line [basic] / 4 line load cell Input
<input type="checkbox"/> Front panel key lock
<input type="checkbox"/> User message output functions
<input type="checkbox"/> High & low limit, zero, OK signal output functions (only for LCD, SC)
<input type="checkbox"/> System functions [count, percent, summation] (only for LCD)
<input type="checkbox"/> Tare input functions using key
<input type="checkbox"/> Gravity calibration functions

1-2. Major Functions

<input type="checkbox"/> Various printer connection supports [roll DEP & label DLP printer]
<input type="checkbox"/> Free to set the maximum weight and a division value as a user desires
<input type="checkbox"/> Independent zeroing functions
<input type="checkbox"/> Built-in hardware test functions

1-3. Analog and A/D Conversion

Applied voltage for load cell	DC 5V (350Ω maximum 8 possible connections)
Zeroing range	0 ~ 2mV/V
Input sensitivity	2 Uv / D (OIML,)Ntep, KS
	0.5 uV / D (Non OIML,)Ntep, KS
Non-straightness	0.01% Full Scale
A/D internal resolution	1 / 520,000
A/D external resolution	1 / 10,000 (NTEP,)OIML, KS
	1 / 20,000 (Non NTEP,)OIML, KS (Possible with the use of sufficient output at 2mV/V L/C)
A/D conversion speed	Maximum 80 rounds/second
Weight setup	Full Digital Calibration : SPACTM (Automatic weight setup at once)

1-4. Digital and Display

* Communication (RS 232/422) ensures the free setup of independent use.

Weight display	CI200-A, CI200-S, CI200-SC	LED (6 digit)
	CI201-A	LCD (6 digit + Sign)
Character size	CI200-A	25 mm (Height)
	CI201-A	24 mm (height)
Sign below zero point	"- " minus sign	
Sign for status	ZERO, TARE, GROSS, NET, STABLE, HOLD, UNIT(kg)	

1-5. General Specifications

AC Adapter		AC 100~240 V (DC 12V, 1.25A)
Operating temperature		-10℃ ~ 40℃
Product size	CI200-A CI201-A	139mm(H) x 206mm(L) x 91.05mm(W)
	CI200-S CI200-SC	169.5mm(H) x 250mm(L) x 83mm(W)
Product weight	CI200-A CI201-A	About 1.3kg
	CI200-S CI200-SC	About 1.5kg

1-6. Communication and Option

Basic	COM1 (RS-232 Printer & PC Interface)
Optional	COM2 (RS-232 Printer & Auxiliary Display)
	RS-485 Multi Drop Interface

* COM2 can be selectively used for a printer (RS-232).

2. Specifications in Appearance

2-1. External Dimension (CI200-A, CI201-A)

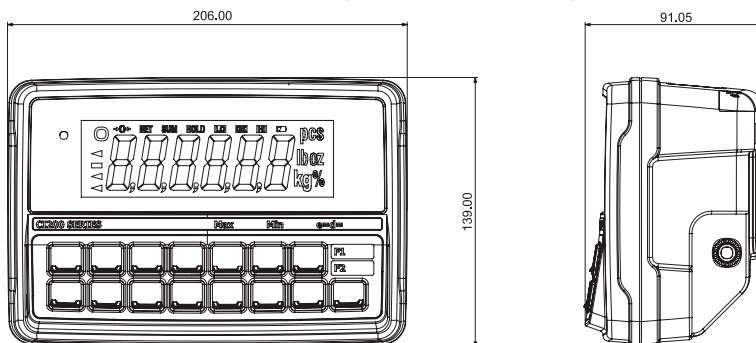

(DESK TYPE)

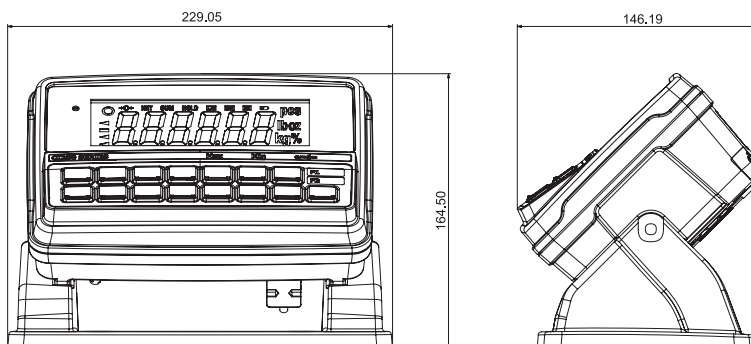

(WALL MOUNT TYPE)

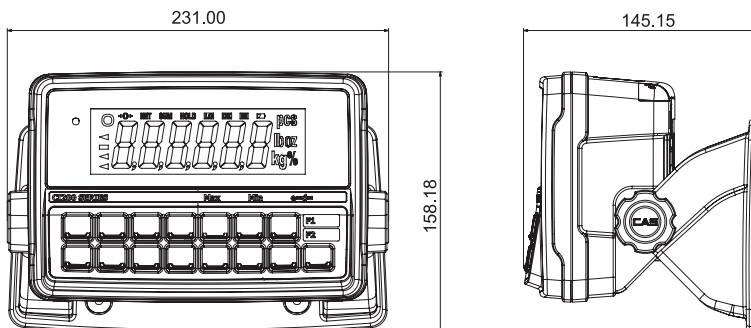

(CI200-S, CI200-SC)

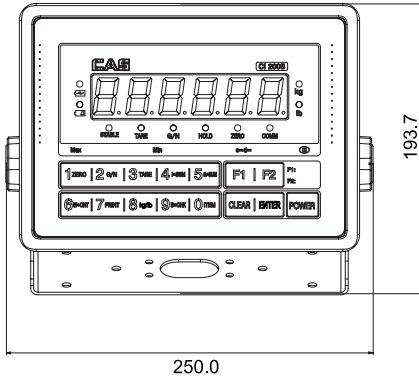

(DESK TYPE)

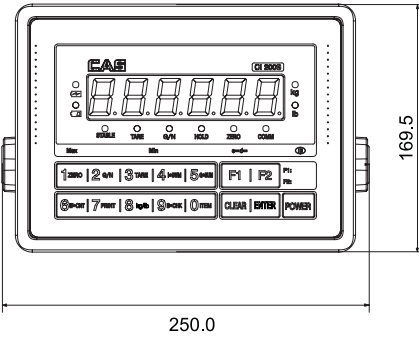
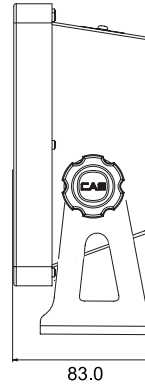

(WALL MOUNT TYPE)

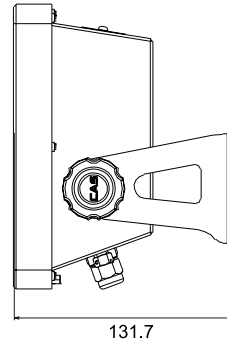

2-2. Front Panel Descriptions

CI200-A

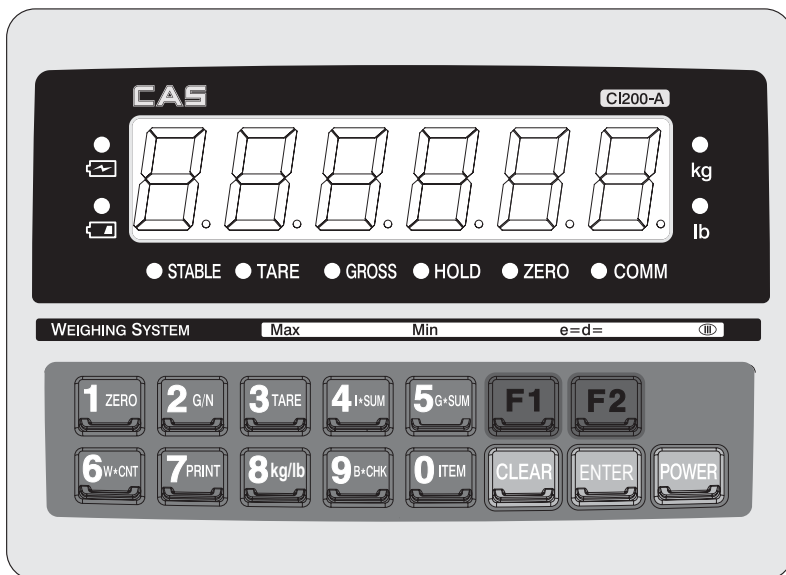

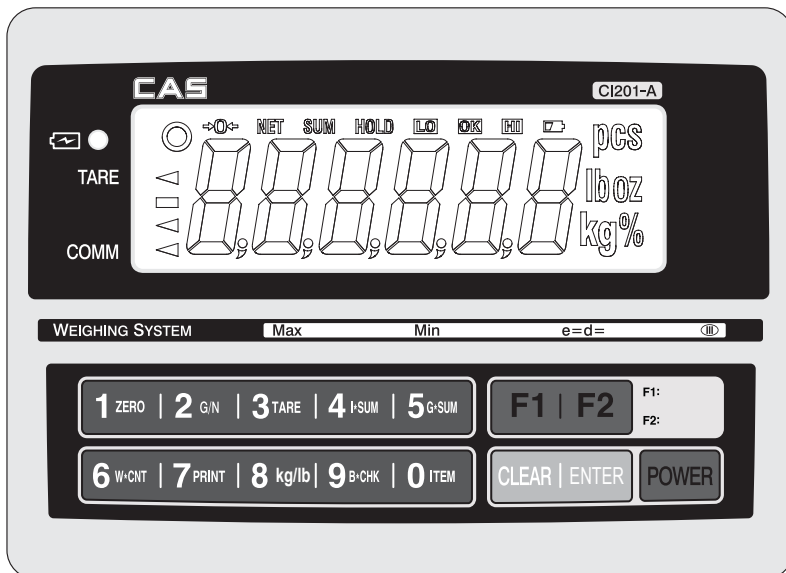

CI201-A



(1) Main Display (Weight Display)

- A. Displaying the value of gross or net weight.
- B. Displaying error messages for any abnormal motion or weigh setup error/
- C. Displaying the status value for the Set Mode and weigh setup mode.

(2) Status Display (Lamp)

LED Lamp	LCD Status Display	Descriptions
Stable	0	The weighed weight is stable.
	NET	The current display of weight is a net weight.
Gross weight		The current display of weight is a gross weight.
Zero point	→0←	The current weight is 0 kg.
		Displayed when the battery should be charged (chargeable battery).
-	HI High limit	The weight is heavier than the upper limit.
-	LO Low limit	The display of lower limit is lit if the value set at F50 is smaller than the lower limit, or greater than the lower limit or smaller than the upper limit.
-	OK Normal	The weight is greater than the lower limit and smaller than the upper limit.
Tare	◁	The current status is at the tare status.
Communication	◁	The current status is at the communication status.
-	SUM Summation lamp	The current weight is the value of summation.
-	PCS Quantity lamp	The current mode is at the count mode.
-	% Percent lamp	The current mode is at the percent mode.

CI200-S

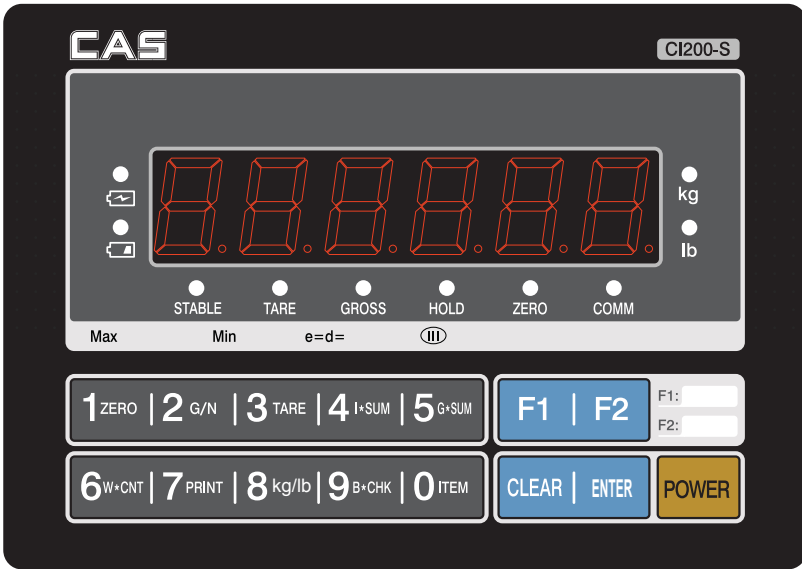

CI200-SC

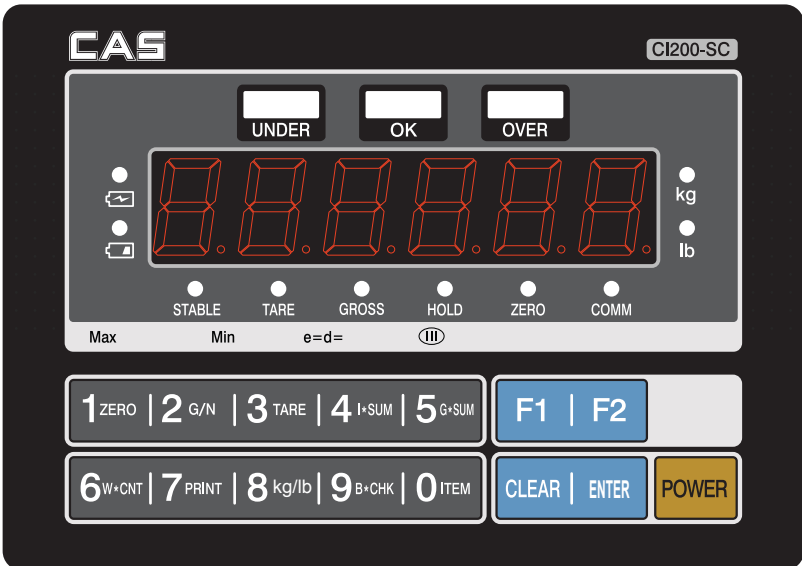

(1) Main Display (Weight Display)



- A. Displaying the value of gross or net weight.
- B. Displaying error messages for any abnormal motion or weigh setup error/
- C. Displaying the status value for the Set Mode and weight setup mode.

(2) Status Display (Lamp)









Stable	The weighed weight is stable.
Tare	The current status is at the tare status.
Gross weight	The currently displayed weight is a gross weight.
kg/lb	The current unit.
Zero point	The current weight is 0 kg.
Communication	The current status is at the communication status.
Kg	The current weight unit is set to kg.
lb	The current weight unit is set to lb.
Lack	The weight is less than the setup value. (SC Only)
Fixed Quantity	The weight is within the setup range. (SC Only)
Excess	The weight is greater than the setup value. (SC Only)





(3) Keyboard

Function Key



	<ul style="list-style-type: none"> * Some functions can be defined to the needs. (The function set at F17 in the Set Mode will be operated.)
	<ul style="list-style-type: none"> * Some functions can be defined to the needs. (The function set at F18 in the Set Mode will be operated.)

Number Key

	<ul style="list-style-type: none"> * It enters 1 in the input mode. * It sets the weight display near zero point to 0. (A range of 2%, 5%, 10%, 20% and 100% can be selected.) * Long press to enter the test mode.
	<ul style="list-style-type: none"> * It enters 2 in the input mode. * Each press after setting up the tare displays the gross weight and the net weight in turn. (The displayed weight is the net weight when the net weight lamp is one, but the displayed weight is the gross weight when the net weight lamp is off.) * Long press to enter the setup mode.
	<ul style="list-style-type: none"> * It enters 3 in the input mode. * Use it to weigh with the tare. * The current weight is memorized as the tare by pressing the key. * Press the key when the load tray is empty to release the tare. * Long press to enter the system selection mode. (CI201-A Only)
	<ul style="list-style-type: none"> * It enters 4 in the input mode. * Use it to check the subtotal (partial summation). * Long press to enter the system weight setup mode. (CI201-A Only)
	<ul style="list-style-type: none"> * It enters 5 in the input mode. * Use it to check the grand total (entire summation).
	<ul style="list-style-type: none"> * It enters 6 in the input mode. * Use it to check the weighing count.
	<ul style="list-style-type: none"> * It enters 7 in the input mode. * Use it for the manual print. (manual print key) (Print format can be changed in the Set Mode.)
	<ul style="list-style-type: none"> * It enters 8 in the input mode. * Use it to fix the shaking weight.

	<ul style="list-style-type: none"> * It enters 9 in the input mode. * Use it to check the remaining capacity of battery.
	<ul style="list-style-type: none"> * Use it to correct any wrong input while entering data. * Use it to enter a decimal point (.) in the weight setup mode and weighing mode.
	<ul style="list-style-type: none"> * It enters 0 in the input mode. * Use it to register an item number. (0 ~ 19)
	<ul style="list-style-type: none"> * Use it to save the current status and exit from the weight setup mode, Set Mode and test mode. * Use it to check the current weight value in PCS and percent mode. (CI20A-A Only)

Double Key

	<ul style="list-style-type: none"> * Use it to print the subtotal.
	<ul style="list-style-type: none"> * Use it to print the grand total.
	<ul style="list-style-type: none"> * Use it for the tare key. * If the tare is known, enter it using the numeric keys. (If the remaining value occurs when the input value is divided into the minimum unit, the value is rounded and entered.) The key tare function cannot be used during the PCS and percent functioning.

2-3. Rear Panel Descriptions

CI200-A, CI201-A

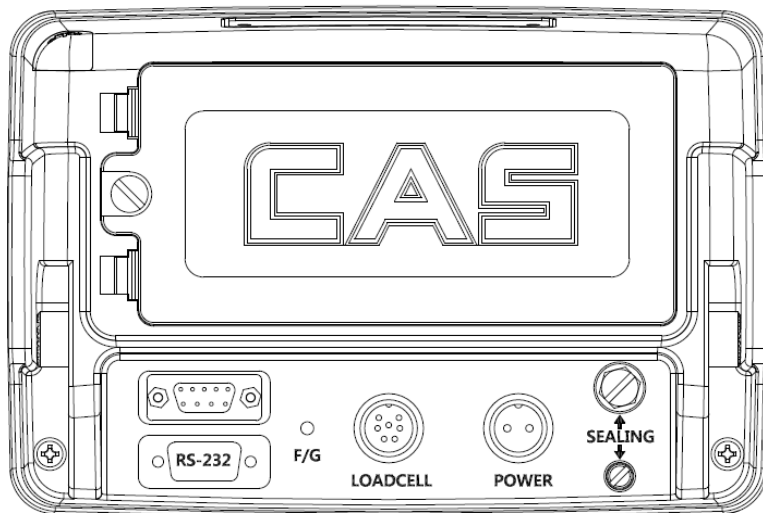

• SEALING (CAL S/W)	Use it to set the weight (calibration).
• POWER	* Use it for the power supply.
• LOAD CELL	A port to connect load cell.
• RS-232C	Serial Com 1 and Com 2 port (connect PC or printer)
• F/G	It is a terminal for grounding to improve electric noises, which is connected to the grounding line upon any abnormalities in the product. (If the grounding terminal of the product is not connected, it might cause failures.)

CI200-S, CI200-SC

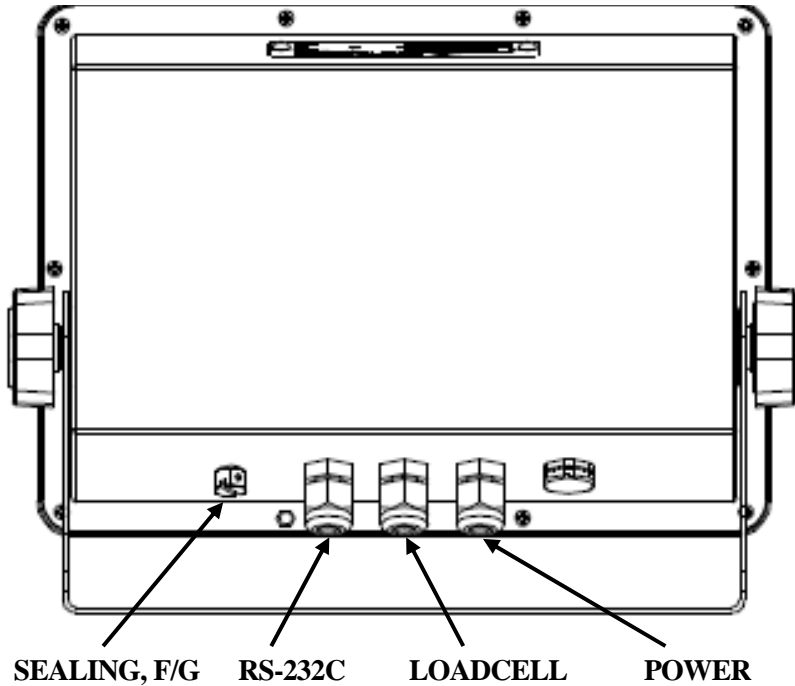

• SEALING (CAL S/W)	Use it to set the weight (calibration).
• POWER	* Use it for the power supply.
• LOAD CELL	A port to connect load cell.
• RS-232C	Serial Com 1 and Com 2 port (connect PC or printer)
• F/G	It is a terminal for grounding to improve electric noises, which is connected to the grounding line upon any abnormalities in the product. (If the grounding terminal of the product is not connected, it might cause failures.)

3. How to Install

3-1. How to Connect Load Cell

Connect the load cell connector to the load cell port on the back of the indicator.

* How to connect the load cell to the connector.

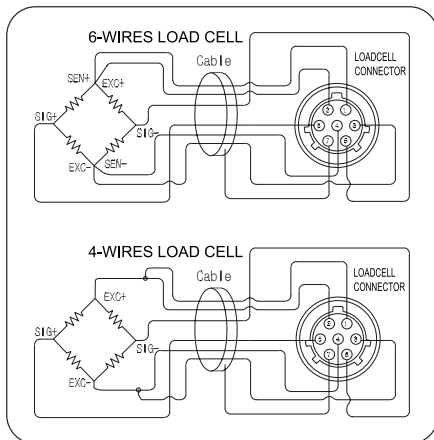

Pin Number	Pin Function
1	EXC+
6	SEN+
2	EXC-
5	SEN-
3	SIG+
4	SIG-
7	SHIELD

Note 1. When 4 line load cell is used, connect EXC+ and SEN+ to '+' power supply terminal in the load cell input, and connect EXC- and SEN- to '-' power supply terminal in the load cell input.

* Relationship between the load cell output and input sensitivity.

The input sensitivity of this product is maximum 0.2uV/digit or more.

The following equation should be satisfied upon the system design.

$$0.2\mu\text{V} \leq \frac{\text{Applied voltage of load cell} \times \text{Output voltage of load cell} \times \text{Value of a division}}{\text{Rated capacity of load cell} \times \text{Number of load cell}}$$

Example 1) Number of load cell: 4 ea

Rated capacity of load cell: 500 Kg

Rated output of load cell: 2mV/V

Value of a division: 0.10 Kg

Applied voltage of load cell: 10V (= 10,000 mV)

According to the equation → $(10000 \text{ mV} \times 2\text{mV} \times 0.1\text{Kg}) / (500\text{Kg} \times 4) = 1 \geq 0.2\mu\text{V}$

As the calculated value is greater than 0.2uV, this weight system design has no problem.

4. Weight Setup (Calibration) Mode

What is the weight setup?

It refers to the calibration to set the displayed value to the actual weight in displaying weights.

How to Access to the Weight Setup Mode

Turn on the power supply to access to the weight setup mode while pressing Cal S/W after removing the sealing. Press the setup key long in the weight setup mode to return to the weighing mode.

4-1. Weight Setup Menu (CAL1 – CAL9)

CAL 1: Maximum capacity

CAL 2: Minimum division and decimal position setting

CAL 3: Weight calibration

3-1. Setting the range of multiple calibration

3-2. Zero calibration

3-3. Setting weight





3-4. Span calibration

CAL 8: Zero adjustment

CAL 9: Factor calibration





CAL 10: Setting dual range

CAL 1 (CAL 1 automatically starts.)

Function: Setting Maximum Value Range of set value: 1 ~ 99,999		
Used key	Display	Descriptions
 :Save and next Menu navigation  ~  : Set value change  :End	C= 10000	Max. value = 10000kg
	C= 10	Max. value = 10kg

Note 1. It means the maximum weight value to be weighed by the scale.

CAL 2

Function: Minimum division and decimal position setting Range of set value: 0.001 ~ 9999		
Used key	Display	Descriptions
 :Save and next Menu navigation  ~  : Set value change  :Set decimal point and end	d= 0.001	Minimum division 0.001 kg
	d= 0.01	Minimum division 0.01 kg
	d= 0.1	Minimum division 0.1 kg
	d= 1	Minimum division 1 kg
	d= 10	Minimum division 10 kg

Note 1. To end CAL2, press  key when a decimal point is set.

Note 2. The minimum division means the value of a division.

Note 3. Set the external resolution within 1/30,000 as the value by dividing the maximum weight by the minimum division.





If the external resolution is 1/30,000 or more, Err 21 is shown.

Note 4. The position of a decimal point is decided by the position of a decimal point for the minimum division set in CAL2.

Note 5. If the minimum division is set to any value out of 1, 2 and 5 unit, "ERR DIV" is shown.

3 CAL

CAL3-1



Function: Setting Multi Calibration Step Range of set value: 1~5		
Used key	Display	Descriptions
 : Save and next Menu navigation	STEP- 1	Setting multi calibration for step 1 (CAL3-3 and CAL 3-4 are carried out once)
 ~  : Set value change	STEP- 3	Setting multi calibration for step 3 (CAL3-3 and CAL 3-4 are carried out three times.)
 : End	STEP- 5	Setting multi calibration for step 5 (CAL3-3 and CAL 3-4 are carried out five times.)

* If the actual curve of load cell is a straight line, set the range of weight setup to 1.

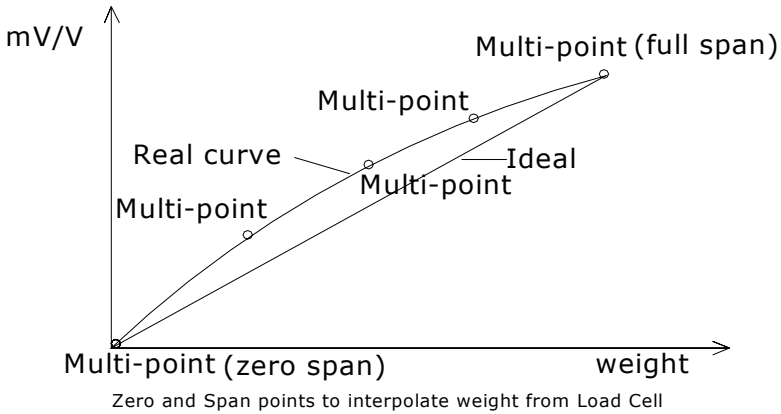
* A function to use, when the output of load cell is corrected by setting multiple points in some sections because the actual curve of load cell is not a straight line.



CAL3-2





Function: Zero Calibration		
Used key	Display	Descriptions
 :Zeroing	UnLoAd	Empty the load tray and press the setup key.
 :End	1234	The current weight value is displayed. Confirm 'Stable' and press the setup key.
	- - -	Zeroing in progress...

Note 1. If zeroing finished with no error, it moves to Setting Weight (CAL 3-3) although no key is pressed.

Note 2. When zero point is too low, an error message "ERR27" is displayed.

Note 3. When zero point is too high, an error message "ERR26" is displayed.

CAL3-3

Function: Setting Weight Range of set value: 1 ~ 99,999		
Used key	Display	Descriptions
 :Save and next Menu navigation	LOAD 1	It means the weight setting mode. (Number = multi calibration number)
 ~  : Set value change	W=100.00	100.00 (unit: Kg or Ton)
 :End	W= 0.10	0.10 (unit: Kg or Ton)



Note 1. Set the weight within a range of 10% ~ 100%.

Although 100% of the maximum weight is given as the initial value, enter the desired weight again if the weight is different from the initial value.

(If the weight exceeds the maximum weight, "ERR 23" is displayed.)

If the weight is 10% or less, "Err 20" is displayed and if the calibration is set to 10% or less, the accuracy is lowered.

CAL 3-4

Function: Weight Calibration)		
Used key	Display	Descriptions
 :Span adjustment	LoAd	Load the weight set in CAL 4-3 and press the setup key. The current weight value is displayed. Confirm 'Stable' and press the setup key. Span adjustment in progress...
 :End	12345	

Note 1. CAL 3-3 and CAL 3-4 are repeated as many as STEP is set in CAL 3-1.

At this time, the weight value should be set to a value greater than the previous one.





Note 2. Move to CAL-1 if the span adjustment is over with no error.

Note 3. When zero point is low, an error message "ERR24" is displayed.

Note 4. When zero point is high, an error message "ERR25" is displayed.



Note 5. After finishing calibration, press the setup key for 2 seconds or more to convert to the weighing mode.

CAL 7

Function: Gravity Adjustment		
Used key	Display	Descriptions
 :Save and next Menu navigation	G-CAL	It means you accessed to the menu for the gravity adjustment.
 ~  : Set value change	Gr-CAL 9.XXXX	
 :End	Gr-SET 9.XXXX	Set the gravity for the place to use the product.

Note 1. If the gravity of the indicator production place is different from that of the place to use, the gravity adjustment can be done using this function.

CAL 8

Function: Zero adjustment - calibration when any zeroing error occurs.		
Used key	Display	Descriptions
 :Zeroing	2-CAL	Empty the load tray and press the setup key.
 :End	1234	The current weight value is displayed. Confirm 'Stable' and press the setup key.
	- - -	Zero adjustment in progress...

Note 1. Use this function when zeroing is not passed for any shock to the load cell.





The range of zero adjustment is 0 ~ 2mV/V.

Note 2. Move to CAL-1 if the zero adjustment is over with no error.

Note 3. When zero point is too low, an error message "Err27" is displayed.

Note 4. When zero point is too high, an error message "Err 26" is displayed.

CAL 9

Function: Factor Calibration		
Used key	Display	Descriptions
 :Save and next Menu navigation	NOT USE	This function cannot be used because of multi calibration.
 ~  : Set value change	FACTOR	It means you entered the factor correction mode.
 :End	12345	The current factor is displayed.

Note 1. As this is a menu to set the weight setup with no weight, general users have no need to use it.





Note 2. This can be used only when the range of multi calibration in CAL 4-1 is set to 1.

"NOT USE" is displayed when the range of CAL 4-1 is set to 2 or larger.

Note 3. Enter a password to enter the factor correction mode.





CAL 10

CAL 10-1

Function: Setting Dual Range Range of set value: 0 ~ 1		
Used key	Display	Descriptions
 :Save and next Menu navigation  ~  : Set value change  :End	DUAL- 0	Dual range function is not used.
	DUAL- 1	Dual range function is used.

Note 1. If the resolution capability is 1/10,000 or higher, "OVER" message is displayed and return to the CAL menu mode.

CAL 10-2

Function: Setting the applied section for the Dual Range Range of set value: 0 ~ 99999		
Used key	Display	Descriptions
 :Save and next Menu navigation  ~  : Set value change  :End	M 1000	Dual range is applied to less than 1000kg.
	M 5000	Dual range is applied to less than 5,000kg.
	M 10000	Dual range is applied to less than 10,000kg.

Note 1. If the input value is greater than the maximum value, "ERR SET" message is displayed and returned to the CAL menu mode.

4-2. How to Seal the Indicator (Sealing)

After the calibration mode is carried out, proceed to the following step.

1. Tighten the CAL switch bolt.
2. Connect the sealing wire as shown in the picture.
3. Press the sealing wax as shown in the picture.

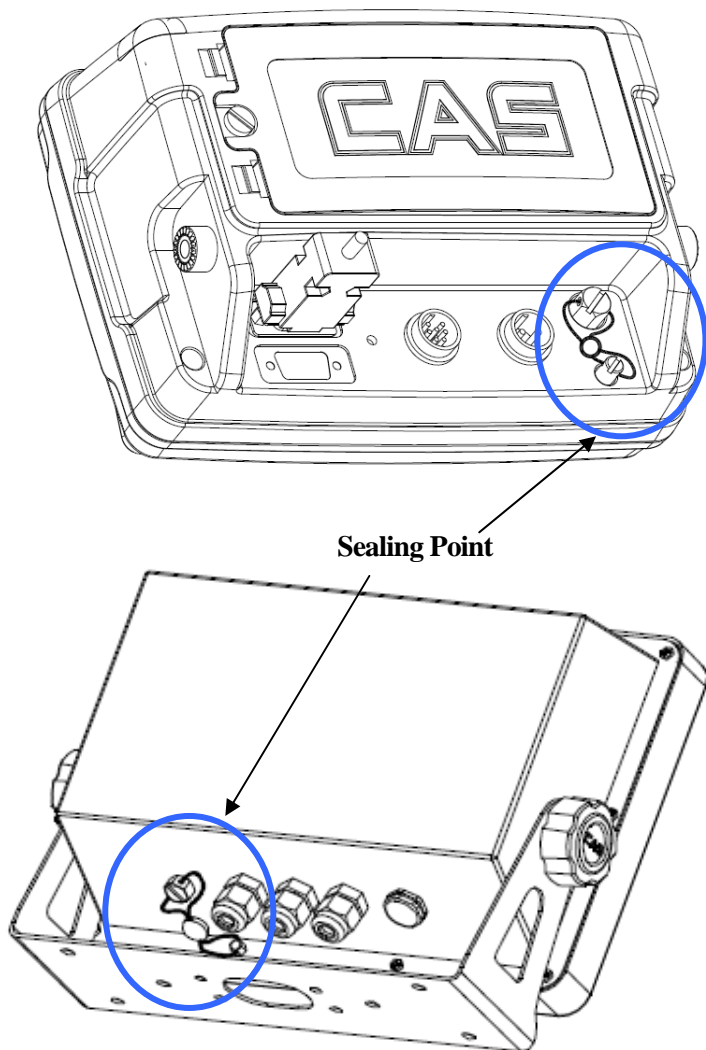

5. Set Mode

5-1. How to Enter the Set Mode

Turn on the power while pressing  key at the indicator front to start the Set Mode.

Or, Hold  key for about 3 seconds to move from other mode to the conversion mode.

After finishing the setup in the Set Mode, press  key for a long time

5-2. Descriptions on key operations in the Set Mode

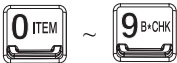

: Use them to change the setup value.



: Save changes in the setup value and move to the higher menu



: Cancel the set value and move to the higher menu

5-3. Set Menu Descriptions (F00 ~ F99)

General Function		
F01	-	Date Change
F02	-	Time Change
F03	(00)	Auto Power Off
F04	(10)	A/D Converting Speed
F05	(10)	Digital Filter
F06	(00)	Vibration Filter
F07	(02)	Motion Detection Condition
F08	(02)	Automatic Zero Tracking Compensation
F09	(00)	Weight Backup
F10	(00)	Set Hold Type
F13	(10)	Set Zero Range
F14	(01)	Set ZERO, TARE Keys Availability
F16	(00)	Set the Front Key Input to be Allowed
F17	(00)	Set "F1" Key
F18	(00)	Set "F2" Key
F21	(10)	Set Initial Zero Range
F23	(09)	Set Excessive Weight Check
F24	(00)	Set Backlight Operational Condition (LCD)
F25	(03)	Set LED Brightness or Backlight Brightness

* Note. Number in () is the default at the factory shipment.

RS-232 Serial Communication Function		
F26	(00)	Device ID
F27	(00)	Parity Bit
F28	(04)	COM1 Baud Rate
F29	(00)	COM1 Usage
F30	(00)	COM1 Output Format
F31	(00)	COM1 - Output Mode
F32	(04)	COM2 Baud Rate
F33	(01)	COM2 Usage
F34	(00)	COM2 Output Format
F35	(00)	COM2 - Output Mode
Print Function		
F40	(02)	Set Printer in Use
F41	(00)	Set Print Format
F42	(00)	Automatic Print
F43	(01)	Print Line Feed
F44	-	User Print Message Input
F45	(01)	Print Output
F47	(01)	Data Initialization after Summation Print
F48	(01)	Print Item Number

Checker Function		
F50	(00)	Measurement Mode
F51	(00)	Checker Buzzer On/Off

Set Mode Initialization		
F90		Password Change
F99	-	Set the Set value of Set Mode to the Factory Default

* Note. Number in () is the default at the factory shipment.

5-3-1. General Function

F01

Function	Date Change	
Numeric key : assigning data	Display	Meaning
	02.01.10	January 10, 2002

F02

Function	Time Change	
Numeric key : assigning data	Display	Meaning
	11.30.10	11 o'clock 30 minutes and 10 seconds AM

F03

Function	Auto Power OFF	
Setting range (00~30)	Display	Meaning
	F03.00	Not used.
	F03.10	Automatic power off after 10 minutes in the waiting mode.
	F03.30	Automatic power off after 30 minutes in the waiting mode.

Note 1. The power is automatically off if the defined time continues at the zero point after the automatic power off is set.

F04

Function	Setting A/D Converting Speed	
Setting range (00~99)	Display	Meaning
	F04.10	10 rounds/second
	F04.20	20 rounds/second
	F04.80	80 rounds/second

F05

Function	Setting digital filter	
Setting range (00~50)	Display	Meaning
	F05.10	Display of average for No. 10
	F05.30	Display of average for No. 30
	F05.50	Display of average for No. 50

F06

Function	Setting vibration filter	
	Display	Meaning
Setting range (00~99)	F06.00	Vibration filter OFF
	F06.10	Compensation for the vibration value of 5 divisions (0.5d * 10)
	F06.99	Compensation for the vibration value of 49.5 divisions (0.5d * 99)

Note 1. Apply this function to a place with heavy vibrations.

(The display response speed becomes slower when the vibration filter is applied.)

Note 2. This function should be adjusted appropriately to the site while the speed of weight variations in F04 is being lowered little by little.

F07

Function	Setting Motion Detection Condition	
	Display	Meaning
Setting range (1~99)	F07. 1	The 'Stable' lamp is lit if the weight changes within 0.5 division.
	F07. 2	The 'Stable' lamp is lit if the weight changes within 1 division.
	F07.10	The 'Stable' lamp is lit if the weight changes within 5 division.

F08

Function	Setting Automatic Zero Tracking Compensation	
	Display	Meaning
Setting range (0~9)	F08. 0	Automatic zero function is not used.
	F08. 1	If it changes slowly to 0.5 divisions or less, it is compensated.
	F08. 2	If it changes slowly to 1.0 divisions or less, it is compensated.
	F08. 9	If it changes slowly to 4.5 divisions or less, it is compensated.

Note 1. This function compensates zero automatically if the weight at the zero point does not exceed the division in a certain range within a specific time.

Ex) If F08 is set to "4" when the maximum displayed division is 120.0kg and the value of a division is set to 0.05kg;

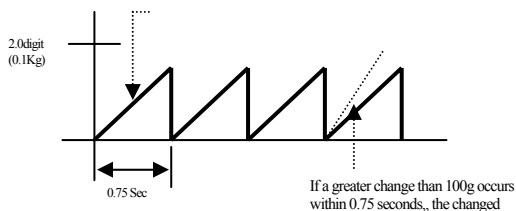

F09

Function	Weight Backup Function	
Setting range (0, 1)	Display	Meaning
	F09. 0	Weight backup is not used.
	F09. 1	Weight backup is used.

Note 1. As the backup state memorizes the initial status at zero for the weighing machine even during the blackout or when the power is turned off, the weight value is displayed if there is any weighing object in the weighing machine when the power is turned on.

If the weighing tray is empty, press the "ZERO" key to memorize the zero again.

F10

Function	Set Hold Type	
Setting range (0~3)	Display	Meaning
	F10. 0	Ordinary hold: calculating the average of weights for shaking objects
	F10. 1	Peak hold: calculating the maximum value for shaking objects
	F10. 2	Sampling hold: calculating the sampling value for shaking objects
F10. 3	Automatic hold: automatically calculating the average weight of shaking objects	

Note 1. If any load more than 'Over' is applied or at the zero, the hold is automatically released.

Note 2. Use automatic hold function, when you weight an animal or moving.

F13

Function	Set Zero Range	
Setting range (0-99)	Display	Meaning
	F13. 2	The 'Zero' Key is operated within 2% of the maximum weight.
	F13. 10	The 'Zero' Key is operated within 10% of the maximum weight.
	F13. 99	The 'Zero' Key is operated within 99% of the maximum weight.

Note. Be aware that the load cell can be damaged if you set the value to F13=10% or more.

F14

Function	ZERO and TARE Keys Availability	
Setting range (0, 1)	Display	Meaning
	F14. 0	Always operated.
	F14. 1	Operated when the weight is 'Stable'.

F16

Function	Set the front key input to be allowed.	
Setting range (0~1)	Display	Meaning
	F16. 0	The front keys are unlocked.
	F16. 1	The front keys are locked.

Note 1. If it is set to 1, some function keys among the front keys cannot be used.
(Print, Hold, Tare, Step, Subtotal, Grand total, Weighing count, Item number, Setup, etc)

F17

Function	Set the use of function key 1	
Setting range (0~15)	Display	Meaning
	F17. XX	Set function key 1 to the key in the code table.

Note 1. Set the desired functions using <Table 1. Function Key Code>.
(LCD product = "11" and LED product = "0" as the default at the product shipment)

F18

Function	Set the use of function key 2	
Setting range (0~15)	Display	Meaning
	F18. XX	Set function key 2 to the key in the code table.

Note 1. Set the desired functions using <Table 1. Function Key Code>.
(LCD product = "12" and LED product = "0" as the default at the product shipment)

Table 1> Function Key Code Table

Function Name	Key Code	Function Name	Key Code
Empty	00		
Zero Point	01	Battery	09
Gross Weight * Net Weight	02	Item Number	10
Tare	03	High Limit (LCD, SC Only)	11
Subtotal	04	Low Limit (LCD, SC Only)	12
Grand Total	05	Tare Lease	13
Weighing Count	06	Piece Weight Value (LCD Only)	15
Print	07		

F21

Function	Set the initial zero range	
Setting range (02~20)	Display	Meaning
	F21. 02	Set the initial zero up to 2% of the maximum weight
	F21. 10	Set the initial zero up to 10% of the maximum weight
	F21. 20	Set the initial zero up to 20% of the maximum weight

Note 1. Please consult with an engineer because setting 10 or larger value might affect the load cell greatly.

F23

Function	Setting the range of check for the excessive weight (weighing unit)	
Setting range (00~99)	Display	Meaning
	F23 09	Excessive weight from the maximum weight + 9 divisions
	F23. 99	Excessive weight from the maximum weight + 99 divisions

F24(CI201-A)

Function	Backlight Operation	
Setting range (0~5)	Display	Meaning
	F24 0	Backlight off
	F24 1	Backlight on when any key is operated.
	F24 2	Backlight on when the weight changes.
	F24 3	Backlight on when it is 'Stable' after the weight changes.
	F24 4	Backlight on when a key operates or the weight changes.
	F24 5	Backlight on all the time

Note. Although it is set to 5, press the power key shortly to turn off the backlight.

F25

Function	Set Backlight and LED Brightness	
Setting range (1~7)	Display	Meaning
	F25 1	Set 10% of brightness
	F25 2	Set 30% of brightness
	F25 3	Set 50% of brightness
	F25 4	Set 60% of brightness
	F25 5	Set 70% of brightness
	F25 6	Set 90% of brightness
	F25 7	Set 100% of brightness

Note 1. Any value out of the setting range, the brightness will be set to '3'.

5-3-2. RS-232 (Serial Communication) Function

F26

Function	Set Device ID	
Setting range (00~99)	Display	Meaning
	F26. 00	Device ID 00
	F26. 99	Device ID 99

Note 1. This function enables to use the unique indicator ID in the command mode.

F27

Function	Set Parity Bit – RS232C & PRT	
Setting range (0~2)	Display	Meaning
	F27. 0	Data bit 8, stop bit 1, parity bit: none
	F27. 1	Data bit 7, stop bit 1, parity bit: even number
	F27. 2	Data bit 7, stop bit 1, parity bit: odd number

Note 1. F26 and F27 apply commonly to 2 serial communications (RS232C and PRT).

Serial Communication COM1 Function

F28

Function	Set COM1 Baud Rate	
Setting range (0~8)	Display	Meaning
	F28. 0	600 bps
	F28. 1	1200 bps
	F28. 2	2400 bps
	F28. 3	4800 bps
	F28. 4	9600 bps
	F28. 5	19200 bps
	F28. 6	38400 bps
	F28. 7	57600 bps
F28. 8	115200 bps	

F29

Function	Set COM1 - Usage	
Setting range (0~1)	Display	Meaning
	F29 0	Connect to a printer
	F29 1	Connect to a computer or auxiliary display

* If F29:0 and F33:0, "ERR-Set" is displayed with no print.

F30

Function	Set COM1 - Output Format	
Setting range (0~2)	Display	Meaning
	F30 0	22 bytes for CA
	F30 1	10 bytes for CA
	F30 2	18 bytes for AND

F31

Function	Set COM1 - Output Mode	
Setting range (0~4)	Display	Meaning
	F31 0	No data out
	F31 1	Transmission for both the stable and instable time (stream mode)
	F31 2	One time transmission after the weight is stabilized.
	F31 3	Transmission only if data is requested. * Data request signal: device ID (F26)_1 byte communication (Data on request: 1=0x01, 10=0x0A)
F31 4	Response to the data request - Command Mode	

Set the value of F31 to '1' or more if the print mode is used.

Note 1. Command Mode Table

Data Request Signal of CI-200											Descriptions on Request Signal	CI-200 Output Signal	
0	1	2	3	4	5	6	7	8	9	10			11
D	dd	K	Z	CR	LF							Zero Point Key	Received Data Return
D	dd	K	T	CR	LF							Zero Point Key	Received Data Return
D	dd	K	G	CR	LF							Gross Weight Key	Received Data Return
D	dd	K	N	CR	LF							Net Weight Key	Received Data Return
D	dd	H	D	CR	LF							Hold Key	Received Data Return
D	dd	K	B	CR	LF							Print Key	Received Data Return
D	dd	K	C	CR	LF							Total Print Key	Received Data Return
D	dd	K	W	CR	LF							Weight Data Request Signal	Received Data Return
D	dd	I	D	0	0	0	0	0	0	CR	LF	Device Number	Received Data Return
D	dd	H	Y	0	0	0	0	0	0	CR	LF	Key Tare Value	Received Data Return
D	dd	H	I	0	0	0	0	0	0	CR	LF	High Limit(LCD Only)	Received Data Return
D	dd	H	L	0	0	0	0	0	0	CR	LF	Low Limit(LCD Only)	Received Data Return

Note 1. (D : 0x44, dd:00~99, K:0x4B, Z:0x5A, CR : 0x0D, LF: 0x0A)

dd= Device Number (2byte), CR = 0x0D, LF: 0x0A

Ex) If a device number is 10, dd becomes 0x31 and 0x30.

Ex) If you want to operate the zero point key when a device number is 11, the indicator operates zeroing if the hex code of “44 31 31 4B 5A 0D 0A” is sent.

Note 1. NT-200 Command Mode Table

Command (ASCII Code)	Description		Status
HI	High Limit	LCD, SC	Read / Write
LO	Low Limit		Read / Write
KT	Key Tare Value		Read / Write
CO	Code		Read / Write
WT	Current Weight		Read
ZE	Operation with ZERO Key		Read
TR	Operation with TARE Key		Read
GN	Operation with Gross/Net Key		Read
ID	Device Number (ID) Change		Read
PR	Operation with PRINT Key		Read
TP	Operation with Total Print Key		Read
PW	POWER OFF		Read

Read

1	2	3	4	5
Device ID	Command		CR	LF

Note 1. Device ID is hex value and Command is ASCII value.

[Ex] If Device ID is 13, a user wants to know the current weight value -> 0x0d
0x57 0x54 0x0d 0x0a

Write

1	2	3	4	5	6	7	8	9	10
Device ID	Command		DATA (Not include decimal point)					CR	LF

Format for Device ID Change

1	2	3	4	5	6
Device ID	Command		DATA	CR	LF

Note 2. When you change code and device number, the data value is HEX 1byte.

Serial Communication COM2 Function

F32

Function	Set COM2 Baud Rate	
Setting range (0~8)	Display	Meaning
	F32 0	600 bps
	F32 1	1200 bps
	F32 2	2400 bps
	F32 3	4800 bps
	F32 4	9600 bps
	F32 5	19200 bps
	F32 6	38400 bps
	F32 7	57600 bps
F32 8	115200 bps	

F33

Function	Set COM2 - Usage	
Setting range (0~1)	Display	Meaning
	F33 0	Connect to a printer
	F33 1	Connect to a computer or auxiliary display

* If F29: 0 and F33 : 0, "ERR-Set" is displayed with no print.

* COM1 and COM2 cannot be used together as the printer function.

F34

Function	Set COM2 - Output Format	
Setting range (0~2)	Display	Meaning
	F34 0	22 bytes for CA
	F34 1	10 bytes for CA
	F34 2	18 bytes for AND

F35

Function	Set COM2 - Output Mode	
Setting range (0~2)	Display	Meaning
	F35 0	No data out
	F35 1	Transmission for both the stable and instable time (stream mode)
	F35 2	One time transmission after the weight is stabilized.

Set the value of F35 to '1' or more if the print mode is used.

5-3-3. Print Function

F40

Function	Set a printer to use	
Setting range (0~2)	Display	Meaning
	F40 0	Not used.
	F40 1	DLP (Label Printer)
	F40 2	DEP (Roll Printer)

F41

Function	Set print format	
Setting range (0~2)	Display	Meaning
	F41 0	Set print format 0
	F41 1	Set print format 1
	F41 2	Set print format 2

F42

Function	Set automatic print	
Setting range (0, 1)	Display	Meaning
	F42 0	Manual print
	F42 1	Automatic print

Note 1. If the automatic print is set, print can be done with no press of print key when the weight is stable.

F43

Function	Set Line Feed	
Setting range (0~9)	Display	Meaning
	F43 1	1 Line feed
	F43 9	9 Line feed

【 Print Format 0 】

Date, Time, Weighing No. (Item No.), Net Weight
Weight

2002. 1. 1	12:30
0001 ID_01:	50.0 kg
0002 ID_01:	100.0 kg
0003 ID_01:	200.5 kg

【 Print Format 1 】

Date, Time, Weighing No. (Item No.), Net

2002. 1. 1	12:30
0001 ID_01:	50.0 kg
2002. 1. 1	12:40
0002 ID_01:	50.0 kg
2002. 1. 1	12:50
0003 ID_01:	50.0 kg

【 Print Format 2 】

Date, Time, Weighing No. (Item No.), Net Weight

	2002. 1. 112:30
No.0001	ID_01
Gross :	1000.0 kg
Tare :	0.0 kg
Net :	1000.0 kg
	2002. 1. 112:40
No.0002	ID_01
Gross :	2000.0 kg
Tare :	500.0 kg
Net :	1500.0 kg

Note 1. If the power is turned off and then on, the number and total are initialized to 0001.

Note 2. The output of item number (ID_XX) depends on the setting in "F48".

Note 3. The possible number for print is a range of 1~9999.

【 Total Print Format 】

Total Format	

ID_01 TOTAL	

2004.06.24	14:32:54
COUNT	22
WEIGHT	4500.05kg

GRAND TOTAL	

2004.06.24	14:32:58
COUNT	123
WEIGHT	12500.10kg

Note 1. When a label printer (DLP-50) is used, the subtotal and grand total functions are not supported and Err-12 is displayed.

Note 2. After summation, data are maintained or initialized depending on the set value in F47.

CAS DLP Protocol

Variable	Descriptions
V00	Gross Weight (8 bytes)
V01	Tare (8 bytes)
V02	Net Weight (8 bytes)
V03	Barcode (Net Weight) (8 bytes)
V04	Count in the Count Mode (8 bytes)
V05	Percent in the Percent Mode (8 bytes)

The weight, count and percent cannot be printed at the same time.
 Values that can be accurately printed are those for [weight, count and percent].

User's Output Message Protocol

Command (ASCII code)	Descriptions	Status
UM	User output message	Write

The maximum length is 40 bytes. 0xFF should be put in the last byte.
 20 bytes are printed in a line and the message starts from the upper left corner.

F44

Function	Enter the user output message	
Set Range (32~255)	Display	Meaning
	12 - 065	Designate a character "A" equivalent to ASCII code 65 in the 12th data
	00 - 032	To print out the added contents, designate ASCII code 32 to 0th data.
	18 - 255	The end has to be meant by designating ASCII code 255 next to the last data.

 ~  : set number,  : coordinate increase,  : end entry

(If a coordinate increase is done when the input range exceed a range of 32 ~ 255, it will be cleared with “255”)

Note 1. This function adds something to write down on the print format.

(Ex: company name, Phone number)

Note 2. Coordinates that can be designated have a range from 0 to 71, of which 0th data designates whether or not to print the added contents (032: printed, others: not printed). Accordingly, the actually printed contents will include contents from 1st data to the part right before the coordinate where data 255 is assigned.

Note 3. If you want to add the company name “CAS” to the existing print format, you might assign as follows;

P00-032 (ASCII code 32: data starts),
 P01-067 (ASCII code 67: character C)
 P02-065 (ASCII code 65: character A)
 P03-083 (ASCII code 83: character S)
 P04-255 (ASCII code 255: data ends)

F45

Function	Set print output	
Setting range (0, 1)	Display	Meaning
	F45 0	Print on both the stable and instable time
	F45 1	Print when the weight is stable.

F47

Function	Initialize data after the summation is printed.	
Setting range (0, 1)	Display	Meaning
	F45 0	Maintain the status
	F45 1	Initialize data after the summation is printed.

F48

Function	Setting print item number	
Setting range (0, 1)	Display	Meaning
	F45 0	Not printing item number on print output
	F45 1	Printing item number on print output

5-3-4. Checker Function

F50

Function	Select the weighing mode (LCD, SC Only)	
Setting range (0 ~ 2)	Display	Meaning
	F50 0	Not used.
	F50 1	Use as the checker mode
	F50 2	Use as the limit mode

[CHECKER MODE]

Weight Comm Signal	(Low Limit)		(High Limit)		OUT PUT
	0 kg	50 kg	100 kg		
LOW					1 0
HIGH					1 0
OK					1 0

Note 1. All the outputs are generated regardless of the stable status.

[LIMIT MODE]

Weight Comm Signal	(Low Limit)		(High Limit)		OUT PUT
	0 kg	50 kg	100 kg		
LOW					1 0
HIGH					1 0
OK					1 0

Note 1. OK signal is displayed only for the stable status.

F51

Function	Set Buzzer On/Off on the Checker Function (LCD, SC Only)	
Setting range (0, 1)	Display	Meaning
	F51 0	General functions are operated as the buzzer.
	F51 1	Buzzer ON when the checker function is OK.

5-3-5. Other Functions

F90

Function	Password Change	
Setting range (0, 1)	Display	Meaning
	F98. 0	Password not changed.
	F98. 1	Password Changed
Password Change	Good	Enter the current password using numeric keys.
	PASS	Enter a new password.
	Change	Enter the new password again.

F99

Function	Set default	
Setting range (0, 1)	Display	Meaning
	0	No initialization functions for indicator.
	1	Carry out the initialization functions for indicator.

Note 1. To set values to the same as the factory default for the indicator, press the setup key after setting F99 to 1.

6. Test Mode

6-1. How to Enter the Test Mode

Test mode starts when the power is turned on while pressing  key in the front of the indicator.

Press the number for the test menu as you wish.

To enter the weighing mode during test, press  key for a long time.

6-2. Test Menu (TEST 1 - TEST10)

Test 1: Key test

Test 2: Display test

Test 3: Load cell test and A/D conversion test

Test 4: RS-232 serial communication test (COM1, COM2)

Test 5: Printer test

Test 8: EEPROM test















Test 9: Battery test

Test 10: Clock (RTC) test

Test 1

Function: Key test		
Used key	Display	Descriptions
 : Higher Menu Other keys: Test	1 1	When you press any key to test, the number and code for the key are displayed on the screen.

<Key List>

Key	Number	Code	Key	Number	Code	Key	Number	Code
	1	1		6	6		0	0
	2	2		7	7		70	30
	3	3		8	8		28	28
	4	4		9	9		29	29
	5	5		11	27			

Test 2

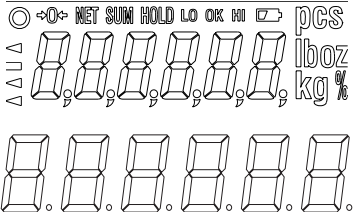
Function: Display Screen Test		
Used key	Display	Descriptions
 : Higher Menu Other keys: Test		<p>An LCD lamp is on.</p> <p>An LED lamp is on.</p>

Test 3

Function: Load cell test and A/D conversion test		
Used key	Display	Descriptions
 : Higher Menu	XXXXXX X.XX	The internal value for the current weight value is displayed. The output value of the current load cell is displayed in mv/V.

Note 1. If  key is pressed, the internal value of the current weight and the output of load cell (mv/V) are displayed repeatedly.

Note 2. Check this number to see if it moves well, while loading or unloading a weight to the load tray. If the number is fixed or “0” is displayed, check the connection of load cell once again.

Test 4

Function: Serial Communication Test		
Used key	Display	Descriptions
 : Higher Menu Other keys: Test	Tx -- Rx ----- 05 --13	Status to wait for transmission or reception Transmission: 5, Reception: 13

Note 1. Run this test while the communication program in the computer (ex: Hyper Terminal) is executing after connecting a serial port in the computer to the serial port on the back.

Note 2. Send ‘1’ from the computer keyboard, check whether or not ‘1’ is received properly on the indicator’s screen, and then check whether or not ‘1’ is received properly on the computer after pressing ‘1’ from the indicator’s keyboard.

TEST 5

Function: Printer Test		
Used key	Display	Descriptions
 : Higher Menu Other keys: Test	Print	No abnormality in the printer. Check the connection of the printer connector..

Note 1. Designate a printer used in the Set Mode (F30) in advance.

Note 2. If the printer connection and the designation are done correctly, the following details will be shown in the printer.

CAS Corporation Come And Succeed TEL 1577-5578 TEST OK

TEST 8

Function: EEPROM Test		
Used key	Display	Descriptions
 : Higher Menu	ROM OK	Displaying the status of EEPROM operation

Test 9

Function: Battery test		
Used key	Display	Descriptions
 : Higher Menu	b 6.15	Displaying the current voltage of battery (6.15V)





Test 10

Function: RTC Test		
Used key	Display	Descriptions
 : Higher Menu	SEC XX	XX : Displaying the progress of seconds (SEC)

Note 1. If  key is pressed, the current second changes to '0'.

7. System Mode (LCD Only)

7-1. How to Enter the System Mode

Step	Display Screen and Key Input	Load Tray	Descriptions
1	Press  key for about 3 seconds in the weighing mode.	Empty	
2	Screen display: “1. PCS” characters are blinking after “SYSTEM” is displayed.		
3	If  key is pressed, “1. PCS” characters are blinking. If  key is pressed, “2. PER” characters are blinking. If  key is pressed, “3. WGT” characters are blinking.		Select the mode to which you want to move.
4	If  key is pressed, the selected mode is set.		









Weighing Mode (I)	
Initial Screen	Descriptions
<p>0 → 0 ←</p> <p>0.000kg</p>	Weighing Mode

Counting Mode (II)	
Initial Screen	Descriptions
<p>0 → 0 ←</p> <p>0 PCS</p>	Counting Mode

Percent Mode (III)	
Initial Screen	Descriptions
<p>0 → 0 ←</p> <p>0.0%</p>	Percent Mode

7-2. PCS MODE









7-2-1. PCS MODE Sample Input Method (LCD Only)

Step	Display Screen and Key Input	Load Tray	Descriptions
1	Press  key for about 3 seconds in the PCS Mode.	Empty	
2	Screen display: "1.SAMPL" characters are blinking.		
3	If  key is pressed, "1. SAMPL" characters are blinking. If  key is pressed, "2. WEIGH" characters are blinking.		Select the input method as desired.
4	Press  +  keys.		
5	Screen display: A/D value is displayed after "SAMPLE" -> "LoAd" is shown. (Wait until the weight is stable.)	Sample	Put samples on the load tray
6	Press  key	Sample	Save sample weight
7	Screen display: "SUCCE" -> "NUMBER" is displayed.	Sample	
8	Enter the number of samples using  ~  keys, and then press  key. (Ex) If 10kg (sample) and 10 pieces, then the unit weight becomes 1kg.	Sample	
9	Screen display: It moves to PCS Mode after displaying "End".	Sample	

Note 1. The current weight is displayed when  key is pressed during operating "1. PCS MODE".

Note 2. If the value of 1 PCS is smaller than 0.7 divisions of maximum resolution capacity when the number of samples is entered, Err-21 is displayed.

7-2-2. PCS Mode Direct Input Method (LCD Only)









Step	Display Screen and Key Input	Load Tray	Descriptions
1	Press  key for about 3 seconds in the PCS Mode.	Empty	
2	Screen display: "1.SAMPL" characters are blinking.		
3	If  key is pressed, "1. SAMPL" characters are blinking. If  key is pressed, "2. WEIGH" characters are blinking.		Select the input method as desired.
4	Press  +  keys.		
5	Screen display: After "WEIGHT" is displayed, "0.000 KG" is displayed.		Weight input mode
6	Enter the weight of PCS using   keys, and then press  key.		Save sample weight
7	Screen display: It moves to PCS Mode after displaying "End".		

Note 1. If  key is pressed during operations in the PCS MODE, it shows the current weight for 3 seconds and then returns to the PCS MODE.

Note 2. If the value of Piece Weight to a function key (F17 or F18), you may confirm the unit weight of 1 PCS.

7-3. PERCENT MODE









7-3-1. Percent Mode Sample Input Method (LCD Only)

Step	Display Screen and Key Input	Load Tray	Descriptions
1	Press  key for about 3 seconds in the Percent Mode.	Empty	
2	Screen display: "1.SAMPL" characters are blinking.		
3	If  key is pressed, "1. SAMPL" characters are blinking. If  key is pressed, "2. WEIGH" characters are blinking.		Select the input method as desired.
4	Press  +  keys.		
5	Screen display: A/D value is displayed after "SAMPLE" -> "LoAd" is shown. (Wait until the weight is stable.)	Sample	Put samples on the load tray
6	Press  key	Sample	Save sample weight
7	Screen display: "SUCCES" -> "NUMBER" is displayed.	Sample	
8	Enter the number of samples using  ~  keys, and then press  key. (Ex) If 10kg (sample) and 10 pieces, then the unit weight becomes 1kg.	Sample	
9	Screen display: It moves to Percent Mode after displaying "End".	Sample	

Note 1. The current weight is displayed when  key is pressed during operating in the Percent Mode.

Note 2. If the value of 1 PCS is smaller than 0.7 divisions of maximum resolution capacity when the number of samples is entered, Err-21 is displayed.

7-3-2. Percent Mode Direct Input Method (LCD Only)



Step	Display Screen and Key Input	Load Tray	Descriptions
1	Press  key for about 3 seconds in the PCS Mode.	Empty	
2	Screen display: "1.SAMPL" characters are blinking.		
3	If  key is pressed, "1. SAMPL" characters are blinking. If  key is pressed, "2. WEIGH" characters are blinking.		Select the input method as desired.
4	Press  +  keys.		
5	Screen display: After "WEIGHT" is displayed, "0.000 KG" is displayed.		Weight input mode
6	Enter the weight of 100% using   keys, and then press  key.		Save sample weight
7	Screen display: It moves to Percent Mode after displaying "End".		

Note 1. If  key is pressed during operations in the Percent MODE, it shows the current weight for 3 seconds and then returns to the PCS Mode.

Note 2. If the value of Piece Weight to a function key (F17 or F18), you may confirm the unit weight of 1 PCS.



8. General Function Descriptions

8-1. Item Number (Unique Number of Weighing Item: ID) Input Method

Step	Display Screen and Key Input	Load Tray	Descriptions
1	Press  key Screen display: "ID = XX"		"Meaning the value of the current item number"
2	Enter a desired ID using number keys		Input ID(=10)
3	Press  key to save and exit	Item	An item number is registered. The weight is displayed.





Note 1. Product ID has a range of 0 ~ 19.

8-2. Key Tare Input Method

Step	Display Screen and Key Input	Load Tray	Descriptions
1	Press  +  keys	Empty	
2	Screen display: "t = 0.000"	Empty	"Meaning the value of the current item number"
3	Enter a desired ID using number keys		
7	Press  key to save and exit		





Note 1. If the remainder occurs when the input value is divided by the minimum unit, it is rounded and entered.

8-3. How to Check Subtotal, Total and Weighing Count

Key	Descriptions
	The current subtotal (partial summation) is displayed.
	The current total (entire summation) is displayed.
	The current subtotal (partial summation) is printed. Subtotal is erased after it is printed.
	The current total (entire summation) is printed. Total is erased after it is printed.
	The current weighing count is displayed.





Note 1. While printing subtotal and total, an error (Err 12) is displayed with no connection to printer, and total and weighing count are erased.
1% unit of weight can be confirmed.

8-4. How to Enter High Limit (LCD, SC Only)

Step	Display Screen and Key Input	Load Tray	Descriptions
1	Press  key. Screen display: "H 0.000"		It means the current high limit.
2	Enter a desired value using   keys.		Change the high limit
3	Press  key to save and exit.	Item	The weight is displayed after the high limit is saved.

Note 1. If the remainder occurs when the input value is divided into the minimum unit, the value is rounded and entered.

8-5. How to Enter Low Limit (LCD, SC Only)

Step	Display Screen and Key Input	Load Tray	Descriptions
1	Press  key. Screen display: "L 0.000"		It means the current low limit.
2	Enter a desired value using   keys.		Change the low limit.
3	Press  key to save and exit.	Item	The weight is displayed after the low limit is saved.

Note 1. If the remainder occurs when the input value is divided into the minimum unit, the value is rounded and entered.

Note 2. If the key code value of F17 and 18 was changed from the initial value, the key code should be set again.

* F1 key's basic value is set to the high limit.

* F2 key's basic value is set to the low limit.

* If the weight is greater than the high limit, the "HI" lamp appears on the screen.

If the weight is smaller than the low limit, the "LO" lamp appears on the screen.

If the weight is smaller than the low limit, the "LO" lamp appears on the screen.

9. Weighing Mode

9-1. Zeroing Function (used when the zero point changes) - LED

■ Range of zero point: within a range set in F13



Zero changed.



Press Zero Key to set the zero lamp on and 0.

9-2. Tare Function (used for weighing with a container) - LED

■ Maximum tare set range: maximum weight

* Caution: the weight including the tare cannot exceed the maximum weight.



Put a container on the load tray.
(Container weight: 10kg)



Press the tare key.
(Tare is saved.)



Put an object on the load tray.
(Net weight: 20kg)

■ If you want to know the total weight;



Press the 'total * net weight' key (the value of object's weight + tare is displayed.)

■ If you want to know the net weight;



Press the 'total * net weight' key (the value of object's weight is displayed.)
Remove the container and object from the load tray to display the saved tare.

■ If the tare is removed;



Remove the container and object from the load tray, and press the tare key (picture on the right) if the saved tare is only displayed (picture on the left).



9-4. Zeroing Function (used when the zero point changes) - LCD

■ Range of zero point: within a range set in F13



Zero changed.



Press Zero Key to set the zero lamp on and 0.

9-5. Tare Function (used for weighing with a container) - LCD

■ Maximum tare set range: maximum weight

* Caution: the weight including the tare cannot exceed the maximum weight.



Put a container on the load tray.
(Container weight: 10kg)



Press the tare key.
(Tare is saved.)



Put an object on the load tray.
(Net weight: 20kg)

■ If you want to know the total weight;



Press the 'total * net weight' key (the value of object's weight + tare is displayed.)

■ If you want to know the net weight;



Press the 'total * net weight' key (the value of object's weight is displayed.)
Remove the container and object from the load tray to display the saved tare.

■ If the tare is removed;



Remove the container and object from the load tray, and press the tare key (picture on the right) if the saved tare is only displayed (picture on the left).



10. Charge and Use Time

- Charge the battery sufficiently when you use the product after storing it for a long time.
- During the use of device,  sign is shown (LCD) or 'LOW BAT' sign (LED) on the upper right corner, and then the power is turned off after a specific time.
When the power supply of battery reaches 5.6V, the battery alert lamp is turned on. When it reaches 5.2V, the power is automatically turned off.
- When the battery alert lamp is turned on, charge the battery.

10-1. How to Use and Charge the Chargeable Battery

- When an adapter is connected, a red light in the power supply lamp and another red light in the charge lamp are turned on.
When the charging is completed, a green light in the charge lamp is turned on.
- The charging takes about 12 hours.
- The complete charge mark is turned on if an adaptor is connected with no battery.

10-2. Use Time of the Battery

	Condition	Use Time
CI200-A CI200-S	-	About 30 hours
CI201-A(LCD)	Backlight OFF	About 180 hours
	Backlight ON	About 33 hours
CI200-SC	-	About 26 hours

※ Note. The time stated above is subject to change depending on the period of battery use and the number of batteries.
To use the battery for a longer time, adjust the automatic power switch function in F03 and the brightness of display in F25.

11. RS-232C Interface in Detail

11.1. RS-232C Port Connection

(1) COM1 - TXD: Pin No. 2, RXD: Pin No. 3, GND: Pin No. 7

RXD	3 O
TXD	2 O
GND	7 O

9 pin port (male)
RS-232C port of CI 200

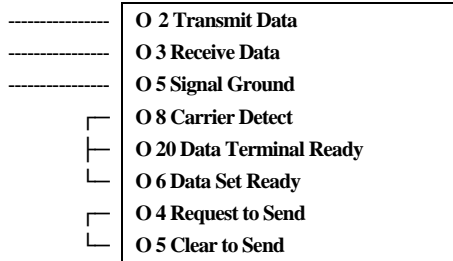

25 pin port (female)
Serial port of the computer

(2) COM2 - TXD: Pin No. 2, RXD: Pin No. 3, GND: Pin No. 7 (Option)

RXD	3 O
TXD	2 O
GND	7 O

9 pin port (male)
RS-232C port of CI 200

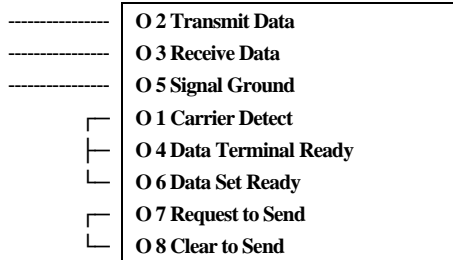

9 pin port (female)
Serial port of the computer

11-2. How to Connect Serial Communication Devices

11-2-1. How to Connect an Auxiliary Display

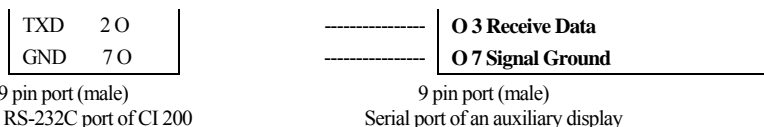

11-2-2. How to Connect a Label Printer (DLP)

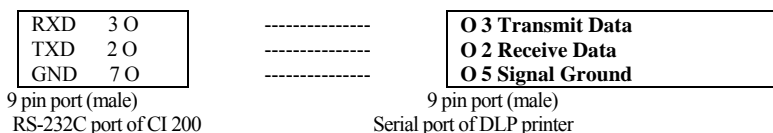

Note. Refer to page 38 (Set Mode) for RS-232C communication and setting method.

11-3. RS-232 Communication Protocol

11-3-1. 22 Bytes for CAS

- (1) Data bit: 8, Stop bit: 1, Parity bit: none
- (2) Code: ASCII
- (3) Set the time to send data to the computer in the Set Mode.
 - Send all the time: if **F30 and F35** are set to 1.
 - Send when the weight is stable: if **F30 and F35** are set to 2.
 - Send upon data request: if **F30 and F35** are set to 3.
 - Only if the computer send 1 byte of the indicator's device ID to the indicator, the indicator makes the defined output format.

RS-422 & 485 Serial Communications (COM2)

RS-422 & 485 transmit signals with the voltage difference, which are more stable for electric noises than other communication methods.

In addition, the AC Power Cable or other electric wires should be placed separately, and the shield cable (0.5Φ or more) dedicated to communications should be applied.

The recommended use distance is within 1.2km.

▶ **Setting output method**

The same as RC232C before

▶ **Signal Format and Data Format**

The same as RC232C before

- 422 Connection Diagram -

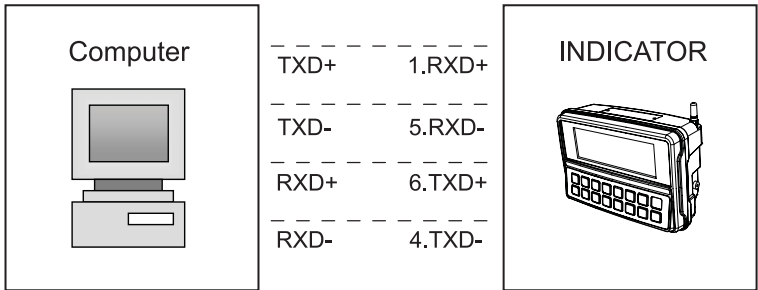

- 485 Connection Diagram -

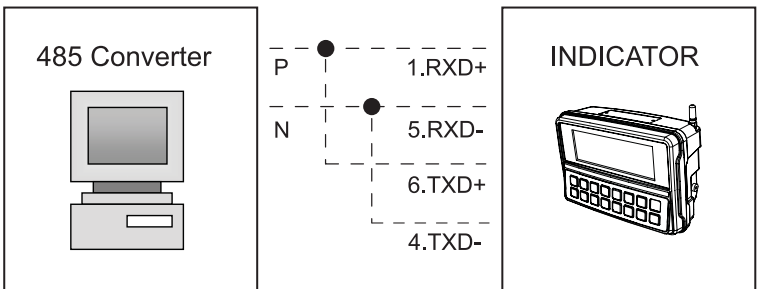

Note. RS-422 & 485 communication is optional specifications, which are supported through COM2. Refer to page 42 (Set Mode) for the setup.

12. Error Message

12-1. Error Message from the Weight Setup Mode

Error	Cause	Solution
Err 20	The resolution was set in excess of the tolerance 1/10,000.	Lower the resolution. As the resolution = maximum tolerance / value of one division, adjust the resolution to 1/10,000 or less by correcting either the maximum allowable weight in CAL 1 or the value of one division in CAL3 in the weight setup mode.
Err 21	The resolution was set in excess of the tolerance 1/30,000.	Lower the resolution. As the resolution = maximum tolerance / value of one division, adjust the resolution to 1/30,000 or less by correcting either the maximum allowable weight in CAL 1 or the value of one division in CAL3 in the weight setup mode.
Err 22	The weight for the span adjustment was set to less than 10% of the maximum capacity.	Set the weight to 10% or more of the maximum capacity (set in CAL 1) from CAL 4 in the weight setup mode.
Err 23	The weight for the span adjustment was set to more than 100% of the maximum capacity.	Set the weight within the maximum capacity (set in CAL 1) from CAL 4 in the weight setup mode.
Err 24	Too low span.	Set the weight again by lowering the resolution as the setting of the current resolution is not possible because of either abnormality or lower output in the load cell. Two low weight for PCS and percent sample.
Err 25	Too high span.	There is either any abnormality or too high output in the load cell. Execute steps from the zeroing step in CAL 4 in the weight set up again. Two high weight for PCS and percent sample.
Err 26	Too high zero point.	Check whether or not the load tray is empty. Retry the weight setup after check at the test mode 3.
Err 27	Too low zero point.	Set the weight setting again after confirming what force is given to the load tray of the scale in the test mode 3.
Err 28	Weight is shaking.	Check the connection of the load cell connector.

12-2. Error Message from the Weighing Mode

Error	Cause	Solution
Err 01	The initialization of the scale cannot be done because of the shaking weight.	Turn on the power after placing the scale at a flat place with no vibration.
Err 02	Either the connection of load cell is wrong or there is abnormality in the A/D conversion section.	Check the connection between the load tray and the body.
Err 05	Either you are pressing a key for a long time or there is abnormality in the key section.	Make an inquiry to A/S.
Err 08	The zero key, tare key and start key were disabled at the instable weight.	Set the zero key, tare key and start key to the proper user conditions at F14 in the Set Mode.
Err 09	The current weight is out of the range of zero point.	Set the range of operations for the zero key to within 2% or 10% at F13 in the Set Mode.
Err 10	The tare to set is out of the maximum weight of the scale.	Set the tare to less than the maximum weight.
Err 12	The type of the configured printer is one that cannot support the total print.	DLP printers cannot make the total print. Set "F40" to '2' when DEP printers are used.
Err 13	The set value of zero point on the weight setting is out of range.	Check the status of the load tray and set the weight again.
Err 15	The range exceeded during setting the item code in the command mode.	Check the range of item code.
Err 82	There is abnormalities in the A/D set section.	Make an inquiry to A/S.
Over	The current weight on the load tray is too heavy and out of the allowable tolerance.	Avoid any weight in excess of the maximum allowable limit on the scale. If the load cell is damaged, it should be replaced.

□ Descriptions on Abbreviation on the Display

Abbreviation	Descriptions	Abbreviation	Descriptions
"LOCK"	Key Lock	"UnLoad"	Unload the load tray
"PASS"	Enter Password	"LoAd"	Load a weight
"Discord"	Re-enter Password	"Good"	Successful Execution
"CAL"	Weight Set Mode	"SyS"	System Mode
"SET"	Set Mode	"PCS"	PCS Mode
"TEST"	Test Mode	"Per"	Percent Mode
"OUEr"	Exceeding Maximum Load		

Appendix I. ASCII Code Table

Character	Code	Character	Code	Character	Code	Character	Code	Character	Code	Character	Code
Space	32	0	48	@	64	P	80	`	96	p	112
!	33	1	49	A	65	Q	81	a	97	q	113
“	34	2	50	B	66	R	82	b	98	r	114
#	35	3	51	C	67	S	83	c	99	s	115
\$	36	4	52	D	68	T	84	d	100	t	116
%	37	5	53	E	69	U	85	e	101	u	117
&	38	6	54	F	70	V	86	f	102	v	118
‘	39	7	55	G	71	W	87	g	103	w	119
(40	8	56	H	72	X	88	h	104	x	120
)	41	9	57	I	73	Y	89	i	105	y	121
*	42	:	58	J	74	Z	90	j	106	z	122
+	43	;	59	K	75	[91	k	107	{	123
,	44	<	60	L	76	\	92	l	108		124
-	45	=	61	M	77]	93	m	109	}	125
.	46	>	62	N	78	^	94	n	110	~	126
/	47	?	63	O	79	_	95	o	111	End	0

MEMO



MEMO

MEMO



CI200 SERIES

Weighing Indicator



CAS BLDG., # 440-1, SUNGNAE-DONG,
GANGDONG-GU, SEOUL, KOREA
TEL_ 82 2 2225 3500
FAX_ 82 2 475 4668
www.globalcas.com