

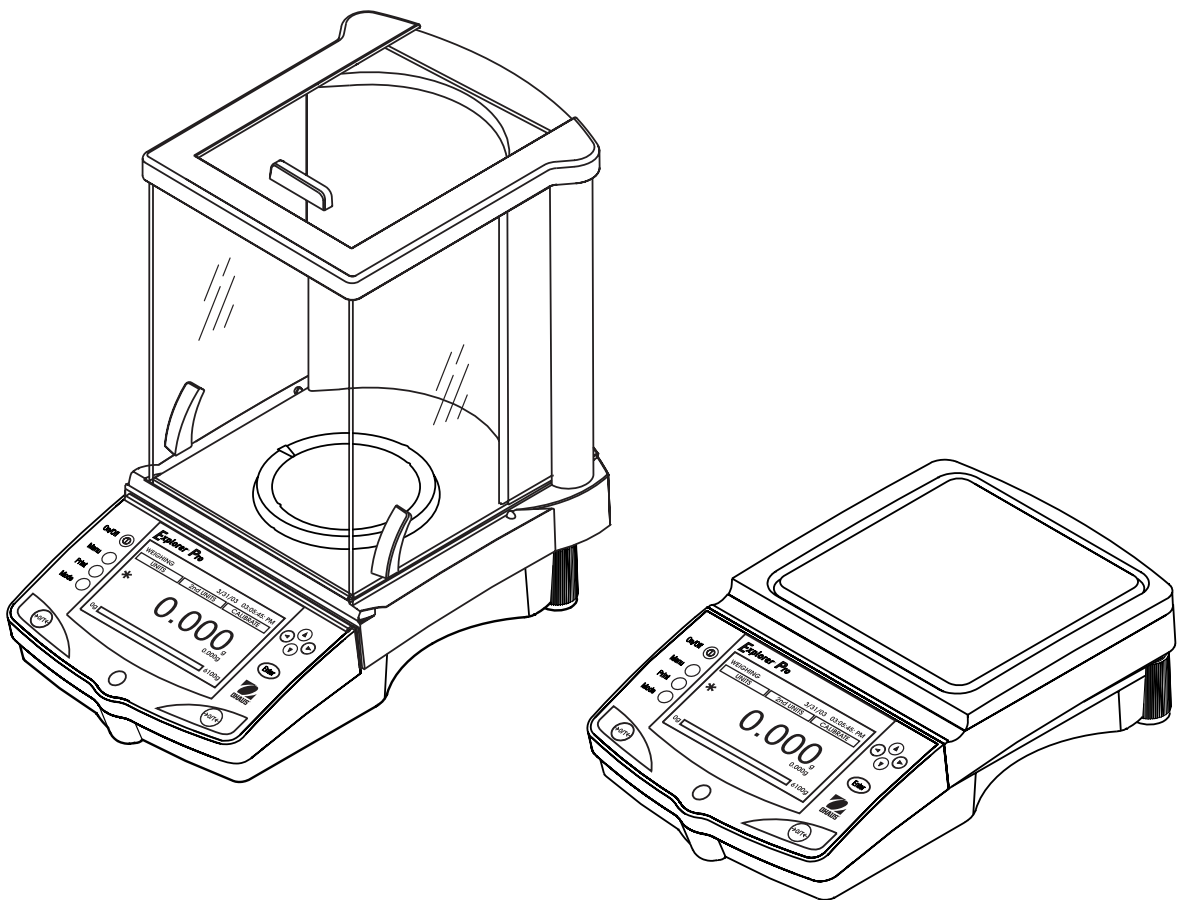

Explorer *Pro* Instruction Manual





Declaration of Conformity

The undersigned, representing the following manufacturer

Ohaus Corporation
19A Chapin Road
PO Box 2033
Pine Brook, NJ 07058 USA

hereby declares that the following products are in conformity with the EEC directives listed below (including any and all modifications).

Balance models: EP64, EP64C, EP64CN, EP64CM, EP114, EP114C, EP114CN, EP114CM, EP164, EP214, EP214C, EP214CN, EP214CM, EP214D, EP214DC, EP214DCN, EP214DCM, EP213, EP213N, EP213C, EP213CN, EP213CM, EP413, EP413N, EP413C, EP413CN, EP413CM, EP513CM, EP613, EP613C, EP613CN, EP613CM, EP413D, EP413DN, EP413DC, EP413DCN, EP413DCM, EP612, EP612N, EP612C, EP612CN, EP612CM, EP1502, EP2102, EP2102N, EP2102C, EP2102CN, EP2102CM, EP4102, EP4102N, EP4102C, EP4102CN, EP6102, EP6102N, EP6102C, EP6102CN, EP6102CM, EP4102D, EP4102DN, EP4102DC, EP4102DC, EP4102DCM, EP410, EP4101N, EP4101C, EP4101CN, EP4101CM, EP6101, EP6101N, EP6101C, EP6101CN, EP6101CM, EP810, EP8101N, EP8101C, EP8101CN, EP8101CM, EPG114, EPG114C, EPG2102, EPG2102C, EPG213, EPG213C, EPG214, EPG214C, EPG214D, EPG214DC, EPG4101, EPG4101C, EPG4102, EPG4102C, EPG4102D, EPG4102DC, EPG413, EPG413C, EPG413C, EPG413D, EPG413DC, EPG6101, EPG6101C, EPG6101C, EPG6102, EPG6102C, EPG612, EPG612C, EPG613, EPG613C, EPG64, EPG64C, EPG8101, EPG8101C

Marked with: Gekennzeichnet mit: Munis de la mention: Contrassegnati con la marcatuara: Con el distintivo:	Directive Richtlinie Directive Directiva Direttiva	Standard Norm Norme Norma Norma
	EU 73/23/EEC Low Voltage Niederspannung Basse tension Baja tensión Bassa tensione	IEC 1010 -1:1990 + A1: 92 + A2: 95 Safety requirements for electrical equipment for measurement, control and laboratory use – Part 1: General requirements Sicherheitsbestimmungen für elektrische Meß-, Steuer-, Regel- und Laborgeräte — Teil 1: Allgemeine Anforderungen Règles de sécurité pour appareils électriques de mesure, de régulation et de laboratoire – Partie 1: Prescriptions générales Requisitos de seguridad de equipos eléctricos de medida, control y uso en laboratorio – Parte 1: Requisitos generales Prescrizioni di sicurezza per apparecchi elettrici di misura, controllo e per utilizzo in laboratorio — Parte 1: Prescrizioni generali
	EU 89/336/EEC Electromagnetic compatibility Elektromagnetische Verträglichkeit Compatibilité électromagnétique Compatibilidad electromagnética Compatibilità elettromagnetica	EN61326: 1997 + A1: 1998 Electrical equipment for measurement, control and laboratory use (Class B) Elektrische Betriebsmittel für Leittechnik und Laboreinsatz —EMV-Anforderungen (Class B) Matériels électriques de mesure, de commande et de laboratoire — Prescriptions relatives à la CEM (Class B) Equipo eléctrico de medida, control y uso en laboratorio — Requisitos de compatibilidad electromagnética (Class B) Apparecchi elettrici di misura, controllo e laboratorio — Prescrizioni di compatibilità elettromagnetica (Class B)
 xx= year CE affixed	EU 90/384 NAWI FNSW BFNA PBNA BFNA	EN45501:1992 Non-automatic weighing instruments Nichtautomatische Wiegevorrichtungen Instruments de pesage à fonctionnement non automatique Instrumentos de pesaje de funcionamiento no automático Strumenti per pesare a funzionamento non automatico

ISO 9001 Registration for Ohaus Corporation. Ohaus Corporation, USA, was examined and evaluated in 1994 by the Bureau Veritas Quality International, BVQI, and was awarded ISO 9001 registration. This certifies that Ohaus Corporation, USA, has a quality system that conforms with the international standards for quality management and quality assurance (ISO 9000 series). Repeat audits are carried out by BVQI at intervals to check that the quality system is operated in the proper manner.



Ted Xia
President
Ohaus Corporation
Pine Brook, NJ USA
Date: July 29, 2003



Urs Müller
General Manager
Ohaus Europe
Greifensee, Switzerland

Additional Standards



CAN/CSA-C22.2 No. 1010.1-92; UL Std. No. 3101-1

Safety requirements for Electrical Equip. for measurement, Control and Laboratory Use, Part 1; General Requirements

FCC

FCC, Part 15, class A Emission



AS/NZS4251.1 AS/NZS4252.1 Emission and Immunity

N13123

Note: This equipment has been tested and found to comply with the limits for a Class A digital device, pursuant to Part 15 of the FCC Rules. These limits are designed to provide reasonable protection against harmful interference when the equipment is operated in a commercial environment. This equipment generates, uses, and can radiate radio frequency energy and, if not installed and used in accordance with the instruction manual, may cause harmful interference to radio communications. Operation of this equipment in a residential area is likely to cause harmful interference in which case the user will be required to correct the interference at his own expense.

This Class A digital apparatus complies with Canadian ICES-003.

Cet appareil numérique de la classe A est conforme à la norme NMB-003 du Canada

TABLE OF CONTENTS

1.	INTRODUCTION	EN-3
1.1	Description	EN-3
1.2	Features	EN-3
1.3	Safety Precautions	EN-3
2.	INSTALLATION	EN-3
2.1	Unpacking	EN-3
2.2	Installing Components	EN-4
2.2.1	Platform Installation	EN-4
2.2.2	Windshield Installation	EN-4
2.2.3	Weigh Below Preparation	EN-4
2.3.	Selecting the Location	EN-5
2.3.1	Balance Location	EN-5
2.3.2	Leveling the Balance	EN-5
2.4	Connecting Power and Communications	EN-6
2.4.1	AC Adapter Installation	EN-6
2.4.2	RS232 Interface	EN-6
2.4.3	Initial Calibration	EN-7
3.	OPERATION	EN-8
3.1	Overview of Controls	EN-8
3.2	Overview of Display Indicator	EN-10
3.3	Menu	EN-11
3.3.1	Menu Structure	EN-11
3.3.2	Navigation	EN-11
3.3.3	Turning On the Balance	EN-11
3.4	Applications	EN-12
3.4.1	Weighing	EN-12
3.4.2	Parts Counting	EN-13
3.4.3	Percent Weighing	EN-17
3.4.4	Animal Weighing	EN-19
3.4.5	Check Weighing	EN-20
3.4.6	Gross/Net/Tare Weighing	EN-21
3.4.7	Filling	EN-22
3.5	Balance Settings	EN-23
3.5.1	Calibration	EN-23
3.5.2	Balance Options	EN-24
3.5.3	Readout	EN-25
3.5.4	Application Modes	EN-26
3.5.5	Units	EN-26

TABLE OF CONTENTS (Cont.)

3.5.6	Interface	EN-27
3.5.7	Print Options	EN-28
3.5.8	GLP Print Options	EN-28
3.5.9	Lockout	EN-29
3.5.10	Factory reset	EN-29
3.9.11	LFT Legal for Trade	EN-30
3.5.12	Hardware Lock Switch	EN-30
3.5.13	Sealing the Balance	EN-30
3.6	Printing Data	EN-30
4.	CARE AND MAINTENANCE	EN-31
4.1	Cleaning	EN-31
4.2	Troubleshooting	EN-31
4.3	Error Codes List	EN-32
4.4	Service Information	EN-33
4.5	Replacement Parts	EN-33
4.6	Accessories	EN-33
5.	TECHNICAL DATA	EN-34
5.1	RS232 Commands	EN-34
5.2	Specifications	EN-35

1. INTRODUCTION

1.1 Description

Thank you for deciding to purchase an Explorer Pro® Balance from Ohaus. Explorer® Pro’s software design allows direct access to 7 application modes and all menus. The backlit dot matrix display, is capable displaying either limited or multiple data fields at each application. Explorer® Pro’s optional AutoCal™ automatically calibrates the balance due to temperature changes that may affect calibration. Panel controls and soft key functions on the display clearly indicate functions and data. Operation is extremely simplified, you enter a menu, select an item, modify the item according to menu selections and exit.

Capacities from 62 grams to 8,100 grams are available. Legal for Trade versions are also available.

To ensure you make full use of the possibilities offered by your Explorer® Pro balance, we advise you to read through these operating instructions.

1.2 Features

- Ready to weigh without complicated setup
- 3 soft keys are application mode specific.
- Operating languages include English, Spanish, French, German and Italian.
- Simplified menu navigation and balance setup.
- Capacity Bar guide and Fill bar guide.
- Flexibility to display either simple weighing results or more advanced results including piece count, average piece weight, sample size, tare weight, weight, under and over.
- Dot Matrix display with backlight
- Weighing, Parts Counting, Animal Weighing, Percent Weighing, Check Weighing, Gross/Net/Tare Weighing and Filling.

1.3 Safety Precautions

Please follow the safety precautions as listed.

CAUTION:

- Do not operate the balance around corrosive fumes.
- Only use the adapter provided with the balance.
- Do not try to service the Explorer® Pro balance.

2. INSTALLATION

2.1 Unpacking

Open the package and remove the instrument and the accessories. Check the completeness of the delivery. The following accessories are part of the standard equipment of your new Explorer® Pro balance.

Pan 3.5", 90mm Round - Analytical 62g, 110g, 162g, 210g, 210/100g
Pan 4.7", 120mm Round - Precision 210g 410g, 510, 610g, 410/100g
Pan 6.8", 152mm Square (0.01 g units) - Precision 610g, 1500g, 2100g, 4100g, 6100g, 4100/1000g
Pan 8", 203mm Square (0.1 g units) - Precision* 6100g, 4100g, 8100g
Draft Shield - Analytical 62g, 110g, 162g, 210g, 210/100g
Draft Shield (0.001g units) - Precision 210g 410g, 610g, 410/100g
Wind Shield (0.01g Units) - Precision 610g, 1550g, 2100g, 4100g, 6100g, 4100/1000g

* 4100 g, 6100 g and 8100 g balances with internal calibration are equipped with a 6" Pan and Windshield.

The following items are supplied with all balances:

AC Power Adapter, Instruction Manual, Warranty Card, In Use Cover

- Remove packing material from the instrument.
- Check the instrument for transport damage. Immediately inform your Ohaus dealer if you have complaints or parts are missing.
- Store all parts of the packaging. This packaging guarantees the best possible protection for the transport of your instrument.

2.2 Installing Components

2.2.1 Platform Installation

Balances are shipped with the pan not installed. On balances equipped with a draft shield, slide open the side door and insert the pan into the center hole.

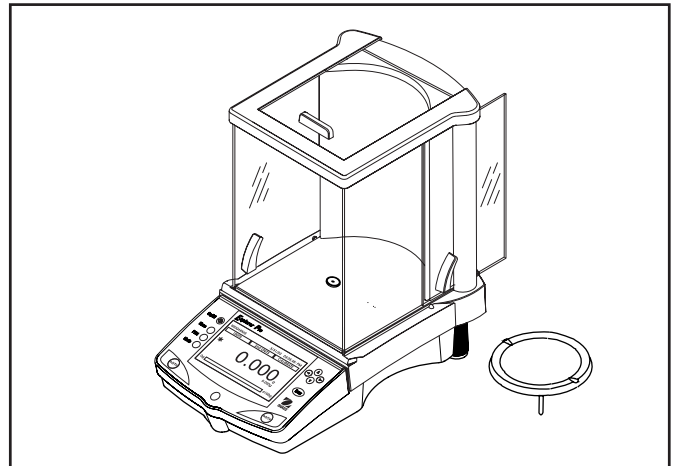

2.2.2 Windshield Installation

On 610 g to 6100 g balances with 0.01 g resolution, a windshield is required to reduce the possibility of air currents from disturbing the pan. When the windshield is in place, air currents are deflected up over the pan. Make sure the windshield is firmly snapped into place.

NOTE: 4100 g, 6100 g and 8100 g balances with internal calibration are equipped with a 6" Pan and Windshield.

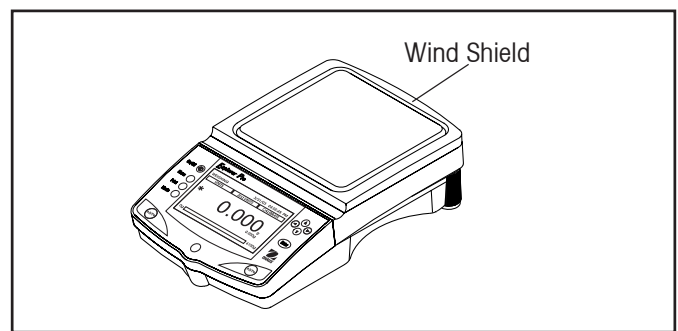

2.2.3 Weigh Below Preparation

The Explorer Pro balance is equipped with a weigh below hook at the bottom of the balance. To use this feature, remove the protective cover underneath the balance. See illustration for location. The balance can be supported using lab jacks or any other convenient method. Make sure the balance is level and secure. Apply power and operate the balance. Attach items to be weighed to the hook underneath the balance.

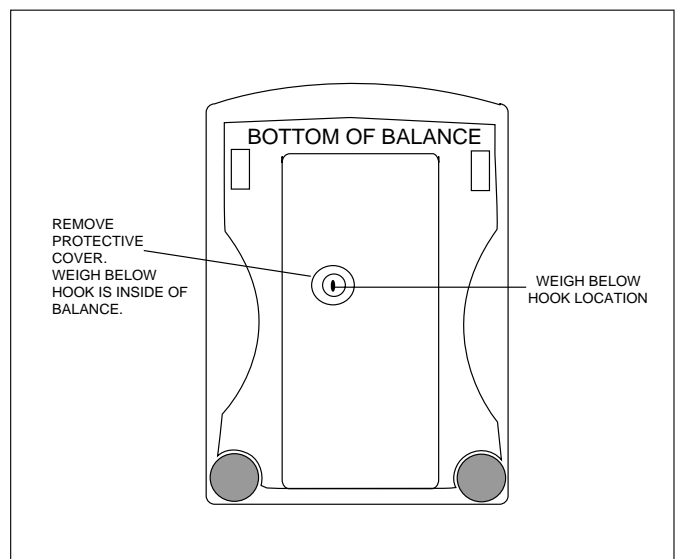

2.3 Selecting the Location

2.3.1 Balance Location

The balance should be used indoors only and in an environment which is free from excessive air currents, corrosives, vibration, and temperature or humidity extremes (Max. 80%). Maximum altitude not to exceed 2000 m above sea level. These factors will affect displayed weight readings.

DO NOT install the balance:

- Next to open windows or doors causing drafts or rapid temperature changes.
- Near air conditioning or heat vents.
- Near vibrating, rotating or reciprocating equipment.
- Near magnetic fields or equipment that generates magnetic fields.
- On an unlevel work surface.
- Allow sufficient space around the instrument for ease of operation and keep away from radiating heat sources.

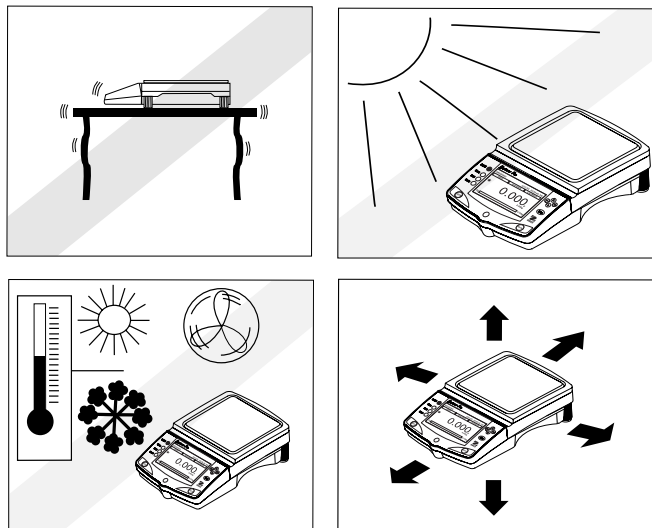

2.3.2 Leveling the Balance

Exact horizontal positioning and stable installation are prerequisites for repeatable results. To compensate for small irregularities or inclinations at the location, the instrument can be leveled.

For exact horizontal positioning, the balance is equipped with a level indicator located at the front on the control panel and two leveling feet located at the rear of the balance.

Position the balance in the intended operating location. Adjust the leveling feet at the rear of the balance until the air bubble in the indicator is centered.

NOTE: The instrument should be leveled each time its location is changed.

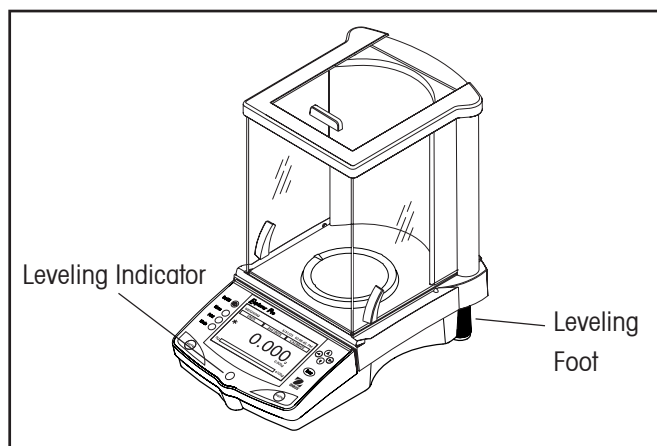
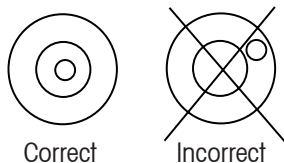

2.4 Connecting Power and Communications

2.4.1 AC Adapter Installation

Connect the AC Adapter supplied to the three pin connector located at the rear of the balance.

The balance is now ready for operation.

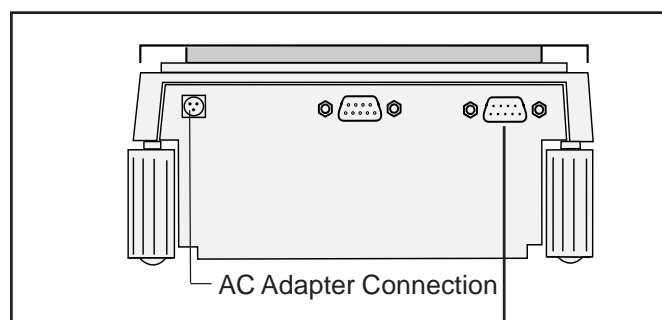

Rear of Balance

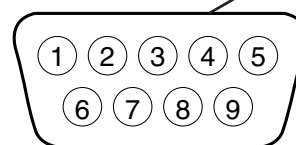

Male Connector

2.4.2 RS232 Interface

Explorer Pro balances are equipped with a bidirectional RS232 compatible interface for communication with serial printers and computers. When the balance is connected directly to a printer, displayed data can be output at any time by simply pressing the **Print** button, or by using the Auto Print feature. Connecting the balance to a computer enables you to operate the balance from the computer, as well as receive data such as displayed weight, weighing mode, stability status, etc.

The following sections describe the hardware and software provided with the balance

Hardware

On the rear of the balance, the right-hand, 9-pin male subminiature "D" connector is provided for interfacing to other devices. The pinout and pin connections are shown in the adjacent illustration. Refer to paragraph 3.5.6 for setup.

The balance is equipped with hardware handshaking, it will not output any data unless pin 5 (CTS) is held in a high state (+3 to +15 V dc). Interfaces not utilizing the CTS handshake may tie pin 5 to pin 6 to defeat it.

Output Formats

Data output can be initiated in one of three ways: 1) By pressing PRINT; 2) Using the Auto Print feature; 3) Sending a print command ("P") from a computer.

Additional information is located in Section 5, Technical Data which contains the RS232 Command Table.

1	N/C
2	Data Out (TXD)
3	Data In (RXD)
4	N/C
5	Clear To Send (CTS)
6	Data Terminal Ready (DTR)
7	Ground
8	Request To Send (RTS)
9	N/C

2.4.3 Initial Calibration

Calibration Masses

Calibration masses are required if the balance is not equipped with internal calibration. Before beginning calibration, make sure masses are available. If you begin calibration and realize calibration masses are not available, exit the menu. The balance will retain previously stored calibration data. Calibration should be performed as necessary to ensure accurate weighing. Masses required to perform the procedures are listed in the following table.

NOTE: Any of the calibration modes can be terminated at any time by pressing the **Menu** button.

CALIBRATION MASSES

CAPACITY	LINEARITY MASSES	SPAN ONLY MASSES
62 g	20g/50 g	50 g
162 g	50g/150 g	150 g
110 g	50g/100 g	100 g
210 g	100g/200 g	200 g
410 g	200g/400 g	400 g
510g/610 g	200g/500 g	500 g
1550 g	500g/1500 g	1500 g
2100 g	1000g/2000 g	2000 g
4100 g	2000g/4000 g	4000 g
6100 g	2000g/5000 g	5000 g
8100 g	4000g/8000 g	8000 g

It is recommended that masses must meet or exceed ASTM Class 1 Tolerance. Calibration masses are available as accessories.

Calibrating from the Weighing Screen

When the balance is first turned on, three soft keys appear on the weighing screen. The CALIBRATE soft key is highlighted. This permits calibration immediately without entering the CALIBRATION menu. On balances equipped with internal calibration, the balance automatically calibrates. On balances that do not have internal calibration, an external mass is required.

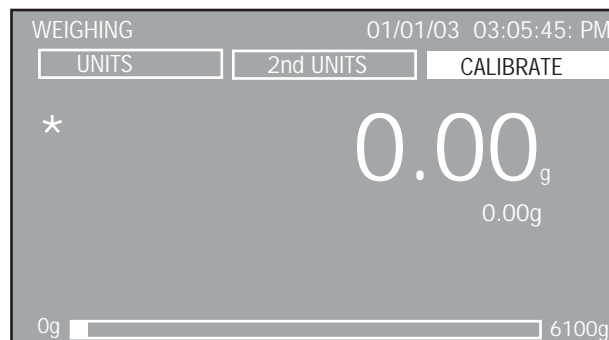

Press the **Enter** button with the CALIBRATE soft key highlighted. On balances that do not have internal calibration, a message appears on screen indicating the mass value to be placed on the pan and also indicates other values of masses that can be used.

Place the required mass on the pan and press the **Enter** button. The balance performs a span calibration.

3 OPERATION

3.1 Overview of Controls

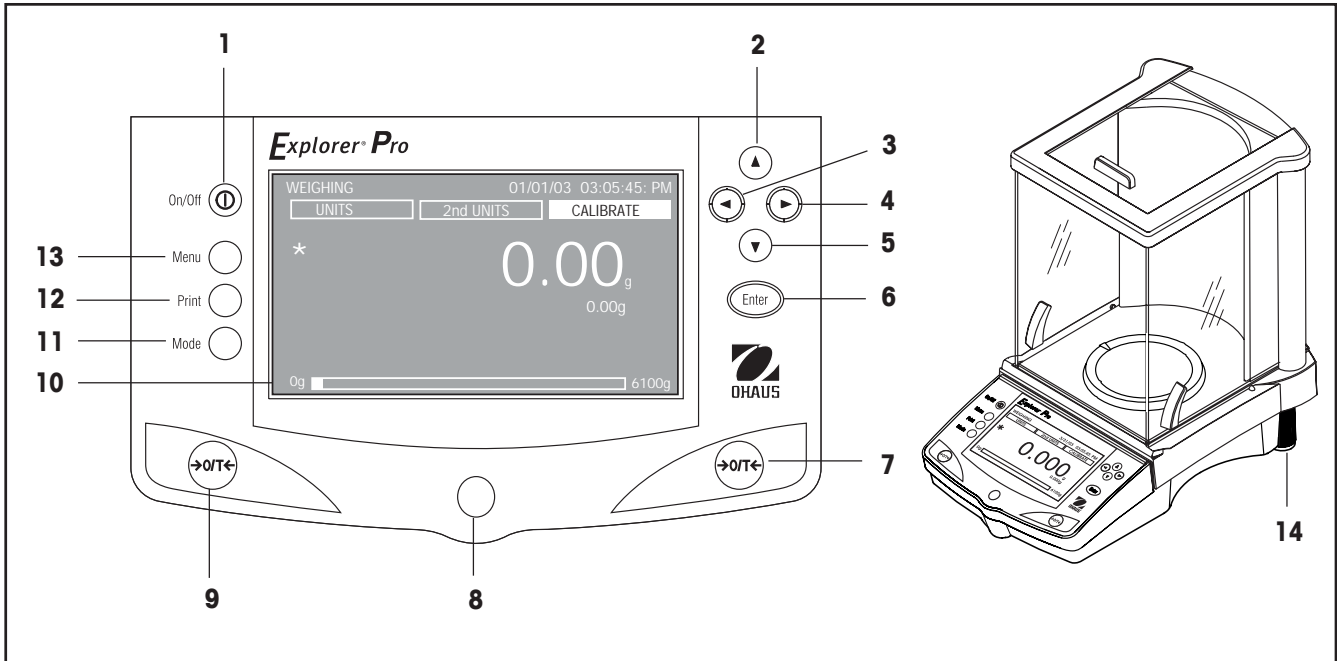

No.	Designation	Function
1	⏻	Power On/ Off button.
2	▲ button	When pressed in Menu mode, single press moves menu selection bar in an up direction and highlights the activated field or changes the settings of a selected field in increasing order. When at an alphanumeric field, then the number or letter is incremented.
3	◀ button	When pressed in Menu mode, single press moves the cursor within a alphanumeric field to the left (example date 07/02/2003). Selection does not wrap at end. In application mode, single press moves to the next soft key selection to the left.
4	▶ button	When pressed in Menu mode, single press moves the cursor within a alphanumeric field to the right (example date 07/02/2003). Selection does not wrap at end. In application mode, single press moves to the next soft key selection to the right.

No.	Designation	Function
5	 button	<p>When pressed In Menu mode, single press moves menu selection bar in a down direction and highlights the selected field or changes the settings of a selected field in decreasing order.</p> <p>When at an alphanumeric field, then the number or letter is decremented.</p>
6	Enter button	<p>When pressed in application modes, functions as an "Enter" button to accept Soft-key selection.</p> <p>When pressed in menu, functions as an "Accept" button for accepting and saving parameter of selected items.</p>
7 & 9	>O/T< buttons	When pressed, performs tare function or zero function.
8	Spirit Level	Provides a leveling indication for the balance.
10	LCD Display	Backlit LCD display provides all necessary indications for operation.
11	Mode button	When pressed, causes the balance to cycle through all active application modes.
12	Print button	When pressed in any application mode, causes a print function to occur.
13	Menu button	When pressed in any application mode, will bring up the Menu screen. Pressing the button within a Menu screen will return to the application mode.
14	Feet	Two adjustable feet used to level the balance.

3.2 Overview of Display Indicator

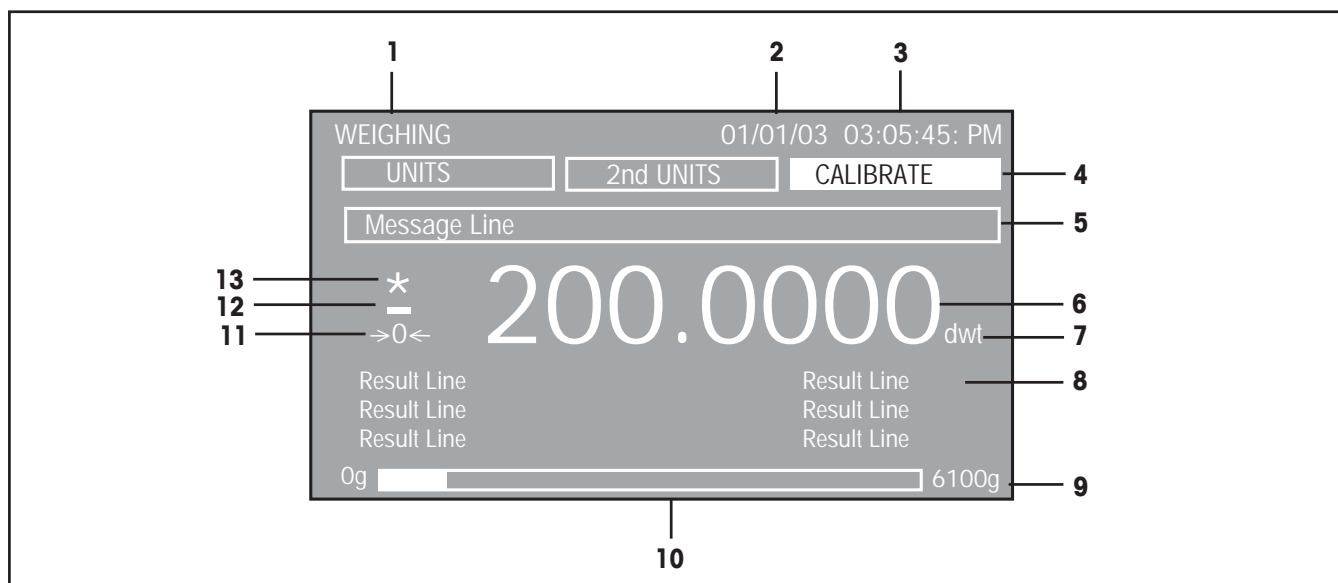

No.	Designation	Function
1	Application	Indicates the active application by function.
2	Date	Indicates current date when properly set.
3	Time	Indicates current time when properly set.
4	Soft Keys	Three Soft-keys are displayed in the upper display area. Depending on the application mode selected, the functionality changes. A Soft-key can be selected by using the left and right arrow buttons. Pressing the Enter button on a highlighted soft-key will activate the function.
5	Message Line	Contains instructional messages.
6	Numerical Display	Indicates primary weight/load.
7	Unit of measure	Indicates active unit of measure.
8	Result Lines 1-6	Six lines that contain balance results.
9	Capacity	Indicates full balance capacity.
10	Bar Graph	Shaded area indicates capacity used for, under, accept, over for check weighing application, or target values for filling application.
11	->0<-	Indicates center of zero (only active in legal for trade).
12	-	Indicates negative value.
13	*	Stability indicator.

3.3 Menu

3.3.1 Menu Structure

The Explorer Pro balance utilizes a menu structure that permits entering various menus by using a dedicated **Menu** button. Pressing the **Menu** button allows access to additional sub menus. See illustration below.



3.3.2 Navigation

When the balance is first turned on, the main weighing screen is displayed. To enter the menu and to change parameters, the following controls are used:

Menu button - When pressed, enters the Menu.

Enter button- When pressed, accepts the menu field selections.

▲ - Scrolls up through the menus.

▼ -Scrolls down through the menus.

◀ - Moves the cursor within the field to the left.

▶ - Moves the cursor within the field to the right.

There are two ways to exit the Menu; one is to scroll to Exit and press the **Enter** button, the other is to press the **Menu** button. All changes will be saved.

To select a highlighted menu, press the **Enter** button. Each menu item contains a display that allows setting balance parameters to individual requirements. These are described in detail in section 3.5 Balance Settings.

Section 3.5.1 describes Calibration procedures and section 3.4 describes the Applications.

3.3.3 Turning on the Balance

The Explorer Pro balance is ready to operate after the installation procedures are performed. When the balance is first turned on and it completes its checks, it can be used to weigh or tare materials without setting the menus.

It is recommended that you read this manual carefully and set the balance to operate to your specific applications before using.

Power On/Off

To turn the balance ON, press the **On/Off** button. To turn OFF, press the button again.

Stabilization

Before initially using the balance, allow time for it to adjust to its new environment. The balance only requires to be plugged in to warm up.

Recommended warm up period is twenty (20) minutes. Analytical Class I balances require at least 2 hours.

The internal circuits of the balance are powered whenever it is plugged into a power source.

3.4 Applications

The Explorer Pro balance contains Weighing, Parts Counting, Animal Weighing, Percent Weighing, Check Weighing, G/N/T and Filling applications. Before using any of these applications, they must be turned on first before they can be accessed. A choice can be made to turn on or off as many of these applications as required. The balance default setting has the weighing mode turned on and all other modes are off.

To select applications to be turned on or off, press the **Menu** button and using the arrow buttons, scroll to Application Modes, then press the **Enter** button.

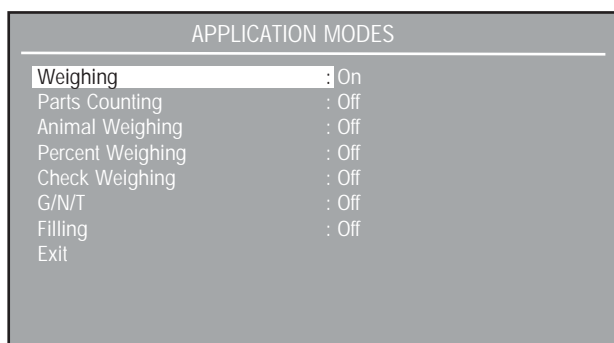
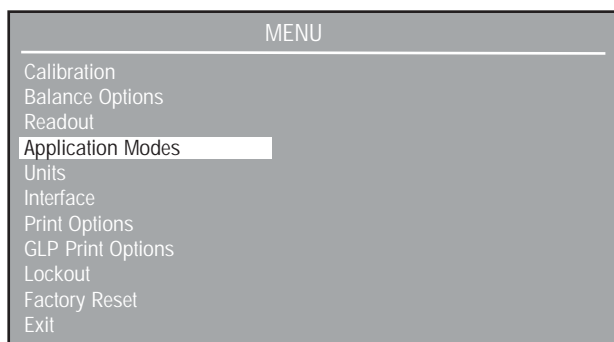

By pressing the **Enter** button and using the arrow buttons, each item on the Application Modes screen can be turned on or off. When finished, press the **Menu** button, the balance returns to weighing mode. All settings are saved.

To use any of the modes that have been turned on, press the **Mode** button repeatedly to cycle through all of the application modes.

3.4.1 Weighing

The Explorer Pro balance is shipped with grams only enabled. The balance can be used immediately after calibration has been performed. When the balance is to be used with other units of measure, the desired unit must be enabled.

USE

Zero the balance. Place objects or material to be weighed on the pan. Example indicates a 200 gram weight on a 6100g balance.

Wait for the stability indicator to appear before reading the weight.

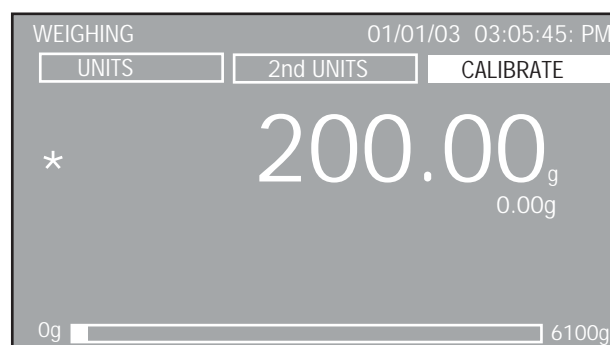

WEIGHING WITH A CONTAINER

With no load on the pan, zero the balance.

Place an empty container on the pan. Its weight is displayed. Tare the balance. The container's weight is stored in memory.

Add material to the container. As material is added, its net weight is displayed.

Removing the container and material from the pan will cause the balance to display the container's weight as a negative number. The tared container weight will remain in memory until the balance is zeroed again or the balance is turned off.

ADJUSTMENTS

Three soft-keys at the top of the display screen labeled UNITS, 2nd UNITS and CALIBRATE are accessed by using the arrow buttons and selected by pressing the **Enter** button.

CALIBRATE

When the CALIBRATE soft key is highlighted, and the **Enter** button is pressed, calibration can be performed.

2ND UNITS

When 2nd UNITS is highlighted, each press of the **Enter** button cycles through the measuring units that are turned On in the Units menu. The last option when cycling through the units is Off.

UNITS

When UNITS is selected and highlighted, each press of the **Enter** button cycles through the measuring units that are On and will appear adjacent to the large numerals.

3.4.2 Parts Counting

The three different Parts Counting modes can be selected, Count, Check or Fill in the Parts Counting Setup. Each mode is described separately.

USE

PARTS COUNTING

In the Parts Counting mode, the balance displays the quantity of parts you place on the pan. Since the balance determines the quantity based on the average weight of a single part, all parts must be reasonably uniform in weight.

The balance has a default setting of 10 pieces. This permits starting parts counting immediately without setting up the balance. The following display indicates the first time operation of parts counting.

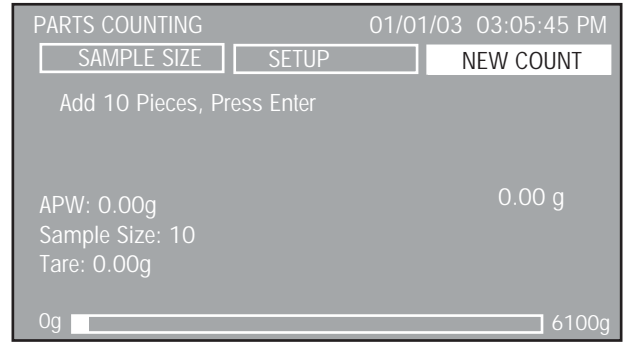

Tare the balance if required. With the NEW COUNT soft key highlighted, press the **Enter** button. Place 10 pieces on the pan as instructed by the blinking text on the display. Press the **Enter** button.

The display now indicates the Average Piece Weight (APW) and the sample size.

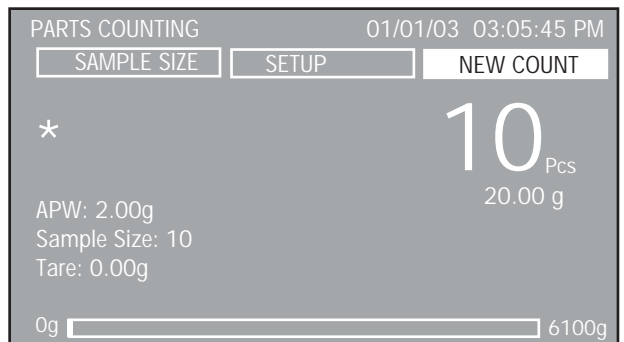

Place parts to be counted on the pan. Balance displays number of pieces.

ADJUSTMENTS

The Parts Counting display contains three soft keys at the top of the screen SAMPLE SIZE, SETUP and NEW COUNT.

NEW COUNT

When NEW COUNT soft key is selected, follow the screen instructions "Add 10 Pieces, Press Enter ". After pressing the **Enter** button, the balance calculates the APW and the display indicates the number of pieces.

SETUP

Select the SETUP soft key and press the **Enter** button. The PARTS COUNTING SETUP is shown.

PARTS COUNTING SETUP	
Mode	: Count
Unit	: g
Sample Size	: 10
APW	: Off
Tare	: 0.00
Auto Optimize	: Off
Display Settings	: Custom
Size/APW Key	: Unlocked
New Count Key	: Unlocked
Exit	

Using the arrow keys and **Enter** button, each item on the display can be entered and modified as required. The following information describes each entry on the screen.

Mode: Count, Check, Fill (default is Count)

Three different modes are available, Count, Check or Fill. The applications for Check and Fill are described in detail after this section.

Unit: g, kg, etc. (default is g)

Cycles through all units turned On in the Units menu. Units can be set active (On) in the UNITS menu.

Sample Size : 0-99 (default is 10)

Defines the amount of pieces used to calculate APW (average piece weight). Setting the sample size will force the APW field to Off and change the APW soft key to SAMPLE SIZE.

APW: 0-999999999 (default is Off)

Defines the average piece weight. Setting the APW will force the Sample Size field to Off and change the SAMPLE SIZE soft key to APW.

Tare: 0-999999999 (default is 0)

Defines the weight of the container being used.

Auto Optimize: On,Off (default is Off)

Selecting Auto Optimize On will recalculate the APW value automatically during the parts counting process up to double the amount of parts. For higher quantities, the APW will not be recalculated. During the auto optimization process, the message "Auto Optimizing, Please wait" will be displayed in the message bar on the screen.

Display Settings: Custom, Default (default is Default)

Selecting Display Settings to Custom will bring up the DISPLAY SETTINGS screen that will allow individual display items to be turned on or off. Selecting Exit will return balance to previous screen.

DISPLAY SETTINGS	
APW	: On
Sample Size	: On
Tare	: On
Weight	: On
Exit	

Size/APW Key: Unlocked, Locked (default is Unlocked)

Allows locking and unlocking the soft key function in the Parts Counting screen. If locked, the message "Key Is Locked" will be displayed in the message bar.

New Count Key: Unlocked, Locked (default is Unlocked)

Allows locking and unlocking the soft key function in the Parts Counting screen. If locked, the message "Key Is Locked" will be displayed in the message bar.

Exit:

When selected, balance returns to the Parts Counting Mode.

SAMPLE SIZE/APW

With SAMPLE SIZE soft key highlighted, press the **Enter** button. The PARTS COUNTING display is shown with the value of the sample size highlighted. Using the arrow buttons and the **Enter** button, the sample size value can be changed.

After the **Enter** button is pressed, and a new sample size has been entered, remove the sample and place parts to be counted on the balance using the new sample size.

APW

With the APW soft key highlighted, press the **Enter** button. The APW is highlighted at the lower left of the screen. Using the arrow buttons and the **Enter** button, the APW value can be changed.

USE

PARTS COUNTING-CHECK

This feature permits establishing a set quantity of pieces as a criteria for similar items that can be quickly checked against the sample. In the Parts Counting Check mode, the displayed data includes, present count (Pcs), APW, Sample Size, Tare, Weight and a bar graph indicating UNDER, ACCEPT (blinking) and OVER .

Refer back to Parts Counting, enter the PARTS COUNTING SETUP menu and change Mode to Check.

The balance is now in the PC CHECK mode.



The balance indicates to add 10 pieces and has an Under value of 5 and an Over value of 10 set up as default values and an average piece weight has not been set. Place 10 pieces on the pan and press the **Enter** button.

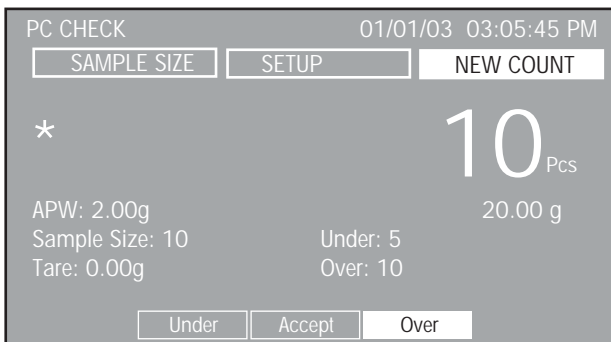

An average piece weight has been set by placing the pieces on the pan. To use the PC Check, the Over and Under values must be set as well as other display setup parameters. Refer to adjustments and set the balance parameters to fit specific requirements.

ADJUSTMENTS

The PC Check display contains three soft keys at the top of the screen SAMPLE SIZE, SETUP and NEW COUNT.

NEW COUNT

When NEW COUNT soft key is selected, follow the screen instructions "Add 10 Pieces, Press Enter ". After pressing the **Enter** button, the balance calculates the APW and the display indicates the number of pieces.

SETUP

Using the left arrow key, select SETUP soft key and press the **Enter** button. The PARTS COUNTING SETUP is shown.

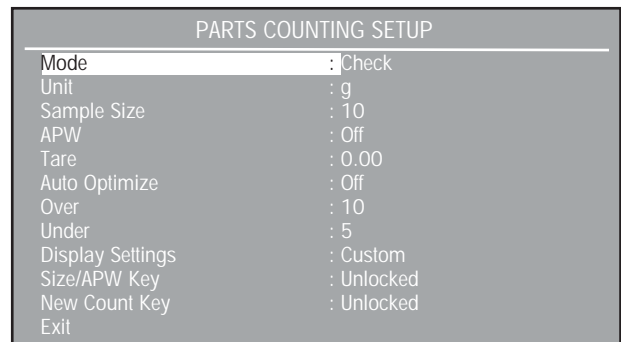

Two additional entries have been added to the PARTS COUNTING SETUP, they are Over and Under. Refer to the Adjustments section of parts counting for a description of all other settings.

Over 10: 0-9999 (default is 10)

Defines the over limit in pieces.

Under 5: 0-9999 (default is 5)

Defines the under limit in pieces.

Display Settings: Custom, Default (default is Default)

Selecting Display Settings to Custom will bring up the DISPLAY SETTINGS screen that will allow individual display items to be turned on or off. Sample Size, Tare, Weight are described under parts counting Display Settings.

Three new entries Weight, Over and Under appear on this screen. Selecting Exit will return balance to previous screen.

Weight: On, Off (default is On)
Can be turned on or off.

Over: On, Off (default is On)
Can be turned on or off.

Under: On, Off (default is On)
Can be turned on or off.

SAMPLE SIZE/APW

Select SAMPLE SIZE soft key and enter the sample size desired.

APW

With the APW soft key highlighted, press the **Enter** button. The APW is highlighted at the lower left of the screen. Using the arrow buttons and the **Enter** button, the APW value can be changed. Follow screen instructions and place sample on pan.

Remove the sample and place items on pan. In the following example, the sample size was 10, the APW was 5.00g, the under value was set at 99 and the over value was set at 101. The acceptable value was 100 pieces.

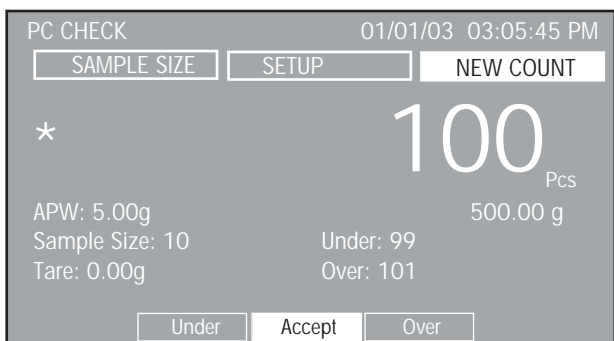

USE

PARTS COUNTING-FILL

This feature permits establishing a set quantity of pieces that can be shown as a percentage when pieces are added. A split bar display indicates 0% to 90% on the first bar and 90% to 110% on the second bar.

Refer back to Parts Counting, enter the PARTS COUNTING SETUP menu and change Mode to Fill. The balance is now in the PC FILLING mode.

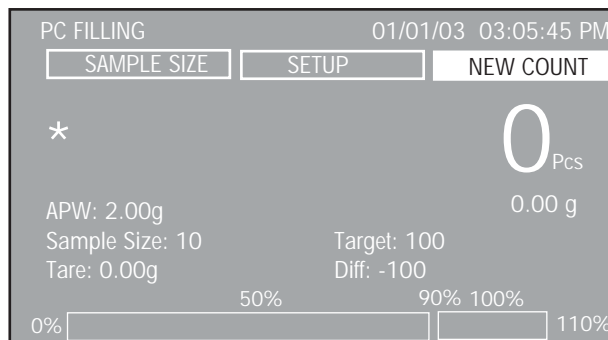

NOTE: The values appearing on the screen initially are from previous entries in parts counting.

Placing an item on the pan at this time will only respond to the previous settings for sample size and APW.

To use PC FILLING, the sample size and other parameters must be set first. Refer to adjustments and set the balance parameters to fit specific requirements.

ADJUSTMENTS

The PC FILLING display contains three soft keys at the top of the screen SAMPLE SIZE, SETUP and NEW COUNT.

NEW COUNT

When NEW COUNT soft key is selected, follow the screen instructions "Add 10 Pieces, Press Enter" is displayed After pressing the **Enter** button, the balance calculates the APW and the display indicates the number of pieces.

SETUP

Select SETUP soft key and press the **Enter** button. The PARTS COUNTING SETUP is shown.

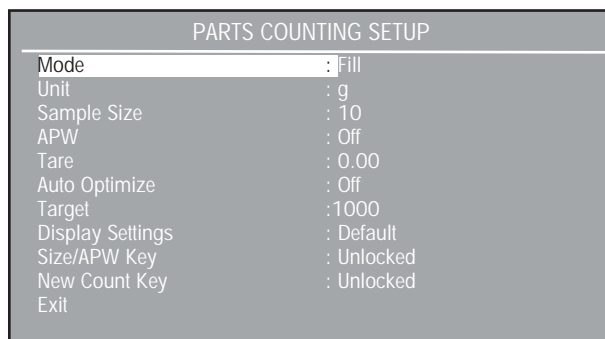

One additional entry has been added to the PARTS COUNTING SETUP, that is Target. Refer to the Adjustments section of parts counting for a description of all other settings.

Target: 0-9999 (default is 1000)

Defines the target pieces for the 100% limit.

Display Settings: Custom, Default (default is Default)

Selecting Display Settings to Custom will bring up the DISPLAY SETTINGS screen that will allow individual display items to be turned on or off. APW, Sample Size, Tare, Weight are described under parts counting Display Settings.

Two new entries Target and Difference appear on this screen. Selecting Exit will return balance to previous screen.

Target: On, Off (default is On)

Can be turned on or off.

Difference: On, Off (default is On)

Can be turned on or off.

SAMPLE SIZE/APW

Select SAMPLE SIZE soft key and enter the sample size desired.

APW

With the APW soft key highlighted, press the **Enter** button. The APW is highlighted at the lower left of the screen. Using the arrow buttons and the **Enter** button, the APW value can be changed. Follow screen instructions and place sample on pan.

Remove the sample and add items on pan until 100% is highlighted at the bottom of the screen as shown. In the following example, the sample size was 10, the APW was 2.00g, the Target value was set at 100 pieces.

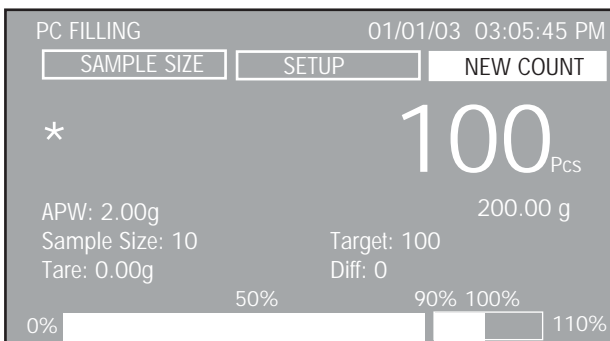

3.4.3 Percent Weighing

Percent weighing allows placing a reference load on the balance, then view other loads as a percentage of the reference. The load placed on the pan as a reference is displayed as 100%. Subsequent loads are displayed as a percentage of the reference are limited. The maximum limit is the capacity of the balance. The minimum limit is 100d. The display data includes reference weight in unit of measurement, difference value in percent, difference value in measuring unit and a bar graph indicating present used capacity of the balance.

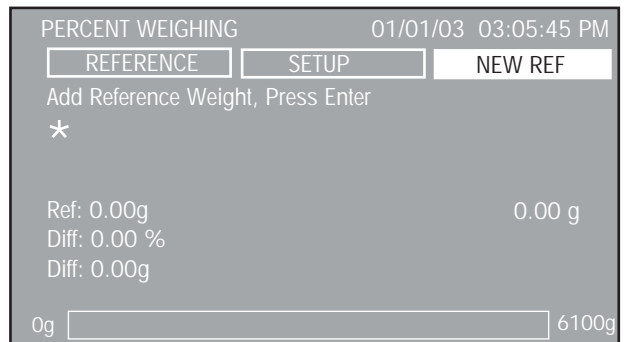

USE

PERCENT WEIGHING

With the NEW REF soft key highlighted, press the **Enter** button. Place the reference weight on the pan and press the **Enter** button again. The sample shown indicates a 200g weight was placed on the pan.

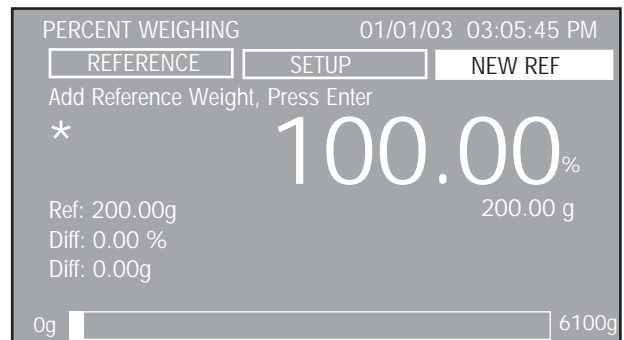

The reference weight is removed and a second weight is placed on the pan. The example illustrates a 50 g weight.

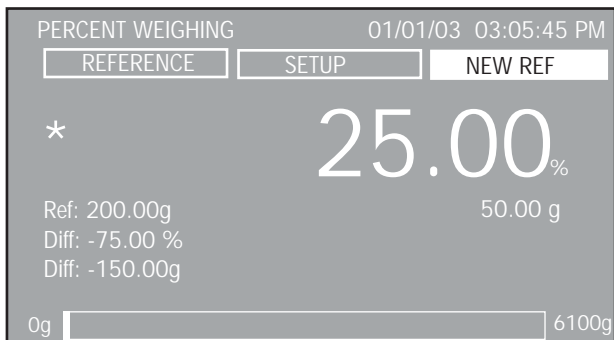

ADJUSTMENTS

The PERCENT WEIGHING display contains three soft keys at the top of the screen REFERENCE, SETUP and NEW REF.

NEW REF

When NEW REF soft key is selected, follow the screen instructions "Add Reference Weight, Press Enter". This establishes a new reference weight.

SETUP

Select SETUP soft key and press the **Enter** button. The PERCENT WEIGHING SETUP display is shown.

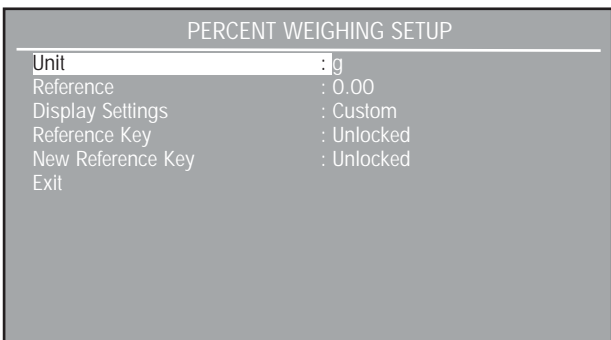

Unit: g, kg, etc...(default g)

Cycles through all units turned On in the Units menu.

Reference: 0-99999999 (default is 10)

Defines the reference weight at 100%.

Display Settings: Custom, Default (default is Default)

Allows setting the display settings On or Off.

Reference Key: Locked, Unlocked (default is Unlocked)

Allows locking or unlocking the REFERENCE soft key in the percent Weighing screen. Message "Key is locked" when Locked is selected.

New Reference Key: Locked, Unlocked (default is Unlocked)

Allows locking or unlocking the NEW REF soft key in the Percent Weighing screen. Message "Key is locked" when Locked is selected.

Exit:

When selected, balance returns to the Percent Weighing Mode.

REFERENCE

Select REFERENCE soft key and press the **Enter** button. The display screen changes with Ref field highlighted. Reference weight can be specified.

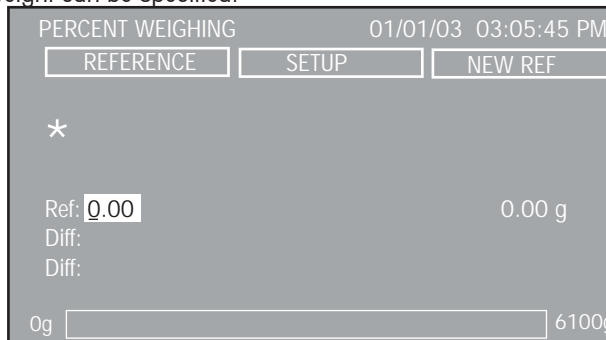

3.4.4 Animal Weighing

Animal weighing permits you to weigh small animals and filters out animal movements. Choices of manual, semi automatic and automatic operation is possible.

The display data includes the filtered weight of the animal in selected unit of measurement, and unfiltered weight of the animal in 2nd unit of measurement, filter level, mode of operation and a bar graph indicating present used capacity of the balance.

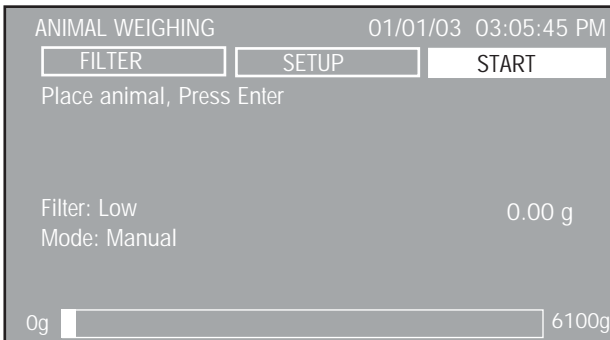

USE

ANIMAL WEIGHING

Place the animal on the pan. With the START soft key highlighted, press the **Enter** button. The display performs a count down to average out the weight. The weight is indicated as shown and remains on the display.

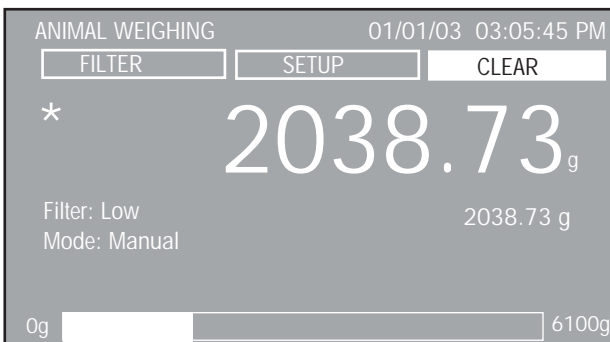

Remove the animal from the pan. With the CLEAR soft key highlighted, press the **Enter** button to clear the weight. The balance is now ready for another measurement. To change the mode of operation from manual to semi automatic or automatic and change filtering levels, refer to Adjustments.

ADJUSTMENTS

The ANIMAL WEIGHING display contains three soft keys at the top of the screen FILTER, SETUP and START/CLEAR .

START/CLEAR

Select the START soft key and press the enter button to start the animal weighing process. The soft key is changed to CLEAR and allows the weight to be cleared when the Enter button is pressed.

SETUP

Select SETUP soft key and press the **Enter** button. The ANIMAL WEIGHING SETUP display is shown.

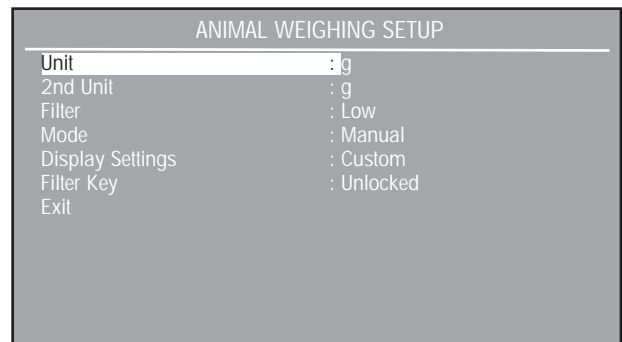

Unit: g, kg, etc...(default is g)

Cycles through all units turned on in the Units menu.

2nd Unit: g, kg, etc...(default is g)

Cycles through all units turned on in the Units menu.

Filter: Low, Medium, High (default is Low)

Can be set one of three filtering levels. A higher level filter will provide more accurate measurement.

Mode: Manual, Semi, Auto (default is Manual)

One of three modes can be set.

Manual Mode

Weighing process starts manually. After placing animal on pan with soft key START highlighted, press the **Enter** button. Screen display retains reading and is manually cleared by pressing the **Enter** button when soft key CLEAR is highlighted.

Semi Automatic mode

Weighing process starts automatically as soon as the animal is placed on the pan. When the animal is removed, the display retains the weight reading. The balance must be cleared manually by pressing the **Enter** button.

Automatic Mode

Weighing process starts automatically as soon as the animal is placed on the pan. The weight is displayed until the animal is removed. The balance is ready for another animal weighing.

Display Settings: Custom, Default (default is Default)

Setting the display to Custom allows individual items Filter, Mode, 2nd weight to be turned on or off. In the default setting, all items are turned on.

Filter Key: Locked, Unlocked (default is Unlocked)

This feature allows to lock or unlock the Soft key function.

Exit

When selected, returns to Animal Weighing mode.

FILTER

Select FILTER soft key and press the Enter button. The display is shown with the Filter: Low highlighted. Pressing the up or down arrow buttons, either Low, Medium or High can be selected, then press the Enter button. Low is the default setting. Display is shown. After selection is made, the screen display returns to an Animal Weighing Mode. A higher filter level will provide a more accurate measurement.

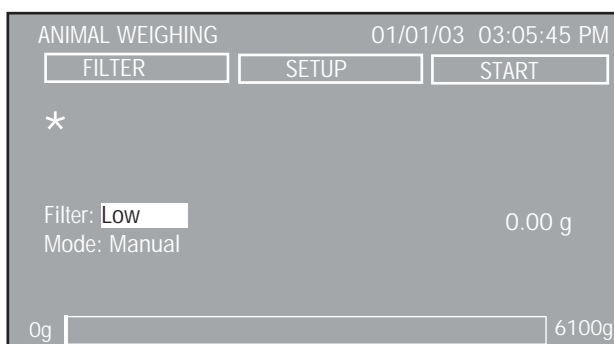

3.4.5 Check Weighing

Check weighing is used when items are checked against preset balance parameters. This feature permits you to weigh an item, set balance parameters such as the over weight, target weight and under weight. A bar graph at the bottom of the Check Weighing screen indicates UNDER, ACCEPT and OVER for items being checked.

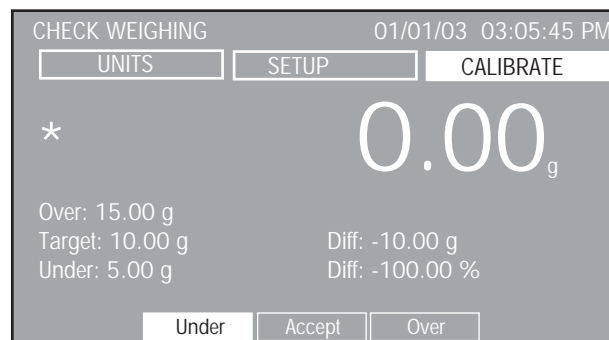

USE

CHECK WEIGHING

Before using the Check Weighing feature, the Over, Target and Under limits must be set.

ADJUSTMENTS

The CHECK WEIGHING display contains three soft keys at the top of the screen UNITS, SETUP and CALIBRATE.

CALIBRATE

When the CALIBRATE soft key is highlighted, an internal span or span calibration can be performed depending upon the model. Press the **Enter** button. Refer to Balance Setting, paragraph 3.5.

SETUP

Select the SETUP soft key and press the Enter button. The CHECK WEIGHING SETUP display is shown.

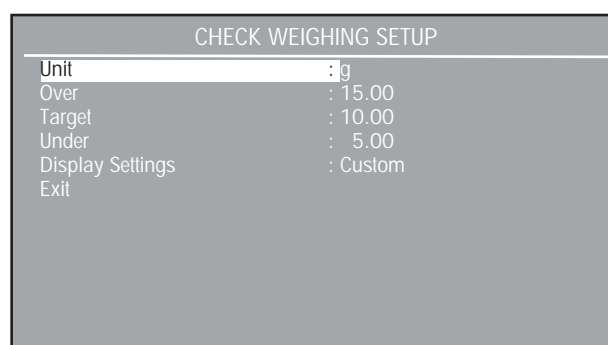

Unit: g, kg, etc...(default is g)

Cycles through all units turned On in the Units menu.

Over: 0-99999999 (default is 15)

Defines over limit value.

Target: 0-99999999 (default is 10).

Defines target value.

Under: 0-99999999 (default is 5)

Defines under limit value.

Display Settings: Custom, Default (default is Default)

Setting the display to Custom allows individual items Over, Target, Under, Difference, Difference % to be turned On or Off. In the default setting, all items are turned on. Additionally, the item reading can be set to weight or message. Default is Weight.

Reading allows a choice of either weight readings to be displayed in large numeral or message that displays OVER, ACCEPT and UNDER in large letters. Display below indicates message format.

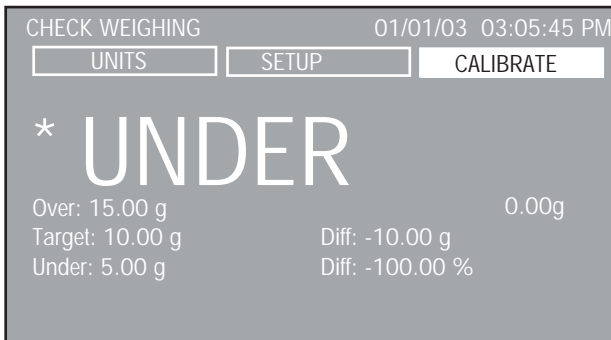

Exit:

When selected, returns to Check Weighing mode.

UNITS

When the UNITS soft key is highlighted, each press of the **Enter** button cycles through the measuring units that are On.

3.4.6 Gross / Net / Tare Weighing

Gross/Net/Tare (G/N/T) application allows to display Gross (sample plus container weight), NET (sample weight) and TARE (container weight) simultaneously.

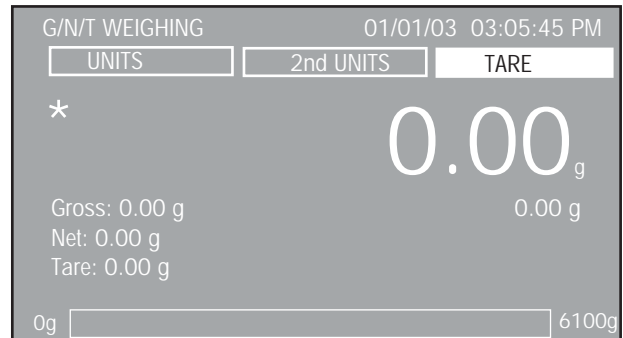

USE

G/N/T WEIGHING

Press the **O/T** button to zero the balance. In this application, the **O/T** button functions as a Zero and not as a Tare.

Place a container on the pan. With the TARE soft key highlighted, press the Enter button. The container's weight is stored in memory in the balance. Place the material in the container. The balance immediately displays the Gross, Net and Tare weights. The net weight is displayed as large numerals. Example shown represents a container weight of 50g and material of 200g. The gross weight is displayed as 250g. Before a new container is used, zero the balance by using the O/T button.

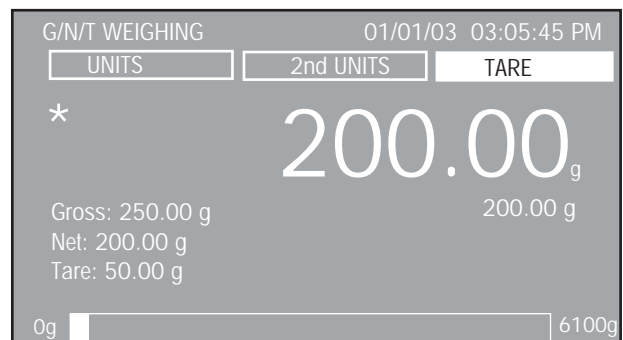

ADJUSTMENTS

The G/N/T WEIGHING display contains three soft keys at the top of the screen UNITS, 2nd UNITS and TARE.

TARE

When the TARE soft key is selected, pressing the **Enter** button will store the current display reading as the tare value.

2nd UNITS

When 2nd UNITS soft key is highlighted, each press of the **Enter** button changes the measuring units that are on and will appear under the large numerals. The last option when cycling through the units is Off.

UNITS

When the UNITS soft key is highlighted, each press of the **Enter** button cycles through all active measuring units on the Gross, Net and Tare displays.

3.4.7 Filling

Filling permits entering a target reference weight. Material can be placed on the pan and by monitoring the Difference weight and the bar display, an accurate fill can be achieved. A split bar display indicates 0% to 90% on the first bar and 90% to 110% on the second bar.

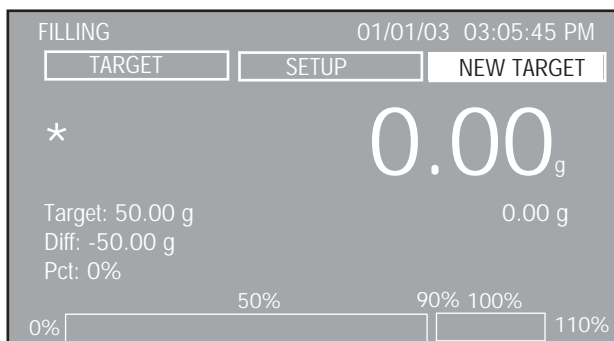

USE

FILLING

A sample (target weight) is placed on the pan and the Enter button is pressed. The balance stores this weight as shown on the display as Target. The sample is removed from the pan and the material is added to the pan. The display provides Target Weight, Difference weight, Percentage and the split bar at the bottom of the screen displays the percentage of the sample compared against the target weight. When a container is used, zero the balance before placing the actual sample on the pan. See Adjustments to set other balance parameters.

ADJUSTMENTS

The FILLING display contains three soft keys at the top of the screen TARGET, SETUP and NEW TARGET.

NEW TARGET

With the NEW TARGET soft key highlighted, press the Enter button. Follow display instructions to "Add Target Weight, Press Enter". This establishes a new target weight and is displayed on the screen.

SETUP

When SETUP soft Key is highlighted, press the **Enter** button. The FILLING SETUP display is shown.

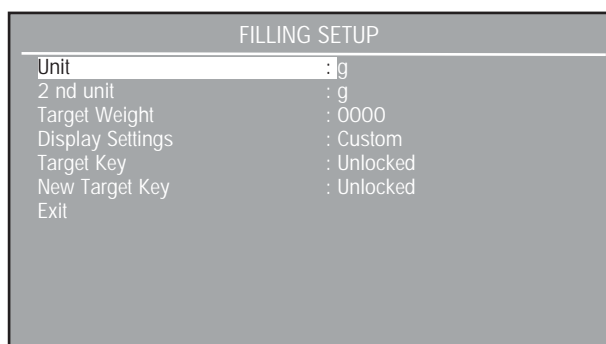

Units: g, kg, etc...(default is g)

Cycles through all units turned On in the Units menu.

2nd UNITS: g, kg, etc...(default is g)

Cycles through all units turned On in the Units menu.

Target Weight: 0-99999999 (default is 0)

Allows entering a specific target filling weight.

Display Settings: Custom, Default (default is Default)

Setting the display to Custom allows individual items Target Weight, Difference, Percent, 2nd weight to be turned On or Off. In the default setting, all items are turned on.

Target Key: Locked, Unlocked (default is Unlocked)

This feature allows to lock or unlock the soft key function.

New Target Key: Locked, Unlocked (default is Unlocked)

This feature allows to lock or unlock the soft key function.

Exit:

When selected, balance returns to the Filling Mode.

TARGET

With the TARGET soft key highlighted, press the **Enter** button.

The FILLING display is shown with the value of the Target highlighted. Using the arrow buttons and the **Enter** button, the Target value can be changed.

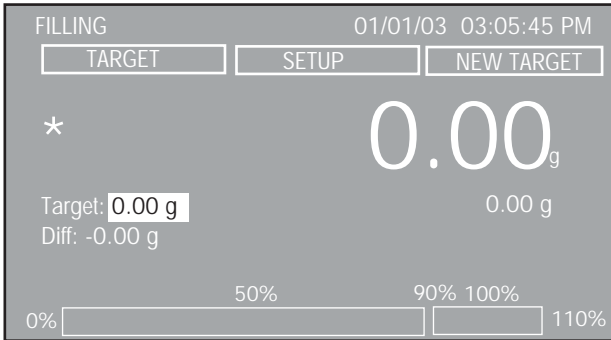

3.5 Balance Settings

The Explorer Pro balance contains ten submenus that are accessible from the Menu. The submenus are Calibration, Balance Options, Readout, Application Modes, Units, Interface, Print Options, GLP Print Options, Lockout and Factory Reset.

Each of the submenus contain settings that will affect the operation of the balance. Please review all submenus settings to obtain the best performance from the balance. Make the necessary settings to suit specific needs.

3.5.1 Calibration

Press the Menu button and select CALIBRATION. Press the enter button, the CALIBRATION screen is displayed. Explorer Pro balances offers a choice of five calibration methods: Internal Calibration, Autocal Calibration, Span Calibration, Linearity Calibration and User Calibration,

Linearity, Span and User calibration are disabled for Type Approved/LFT balances Class II and Class III.

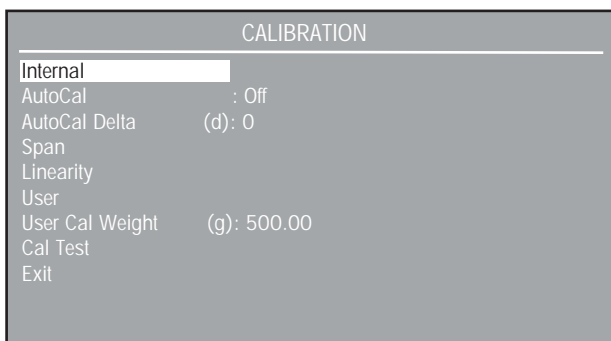

IMPORTANT !
DO NOT DISTURB THE BALANCE
DURING CALIBRATION.

Internal Calibration

On Explorer Pro balances equipped with internal calibration, calibration is accomplished using the internal calibration mass. Internal calibration can be performed at any time providing the balance has warmed up to operating temperature and is level.

AutoCal: On, Off (default is On)

Explorer Pro balances equipped with internal calibration also contain AutoCal. When AutoCal is set ON, the balance performs a self calibration when a measured predefined delta temperature change occurs. After calibration, the display returns to the last application mode. Environmental conditions must be met for the AutoCal to be successfully completed.

AutoCal Delta: -100 - +100 (default is 0)

Explorer Pro balances equipped with internal calibration also contain AutoCal Delta. AutoCal Delta allows the internal calibration mass value to be adjusted. This permits calibrating the balance using an external mass which is traceable to a certified standard.

Perform the internal calibration procedure. After the calibration is completed, zero the balance.

Place a certified mass equal to the **span calibration value** of the balance.

Compare the reading on the balance to the expected weight being used. If the reading is above the expected weight, the delta entered in digits is negative. If the reading is below the expected weight, the delta entered in digits is positive.

See following example:

Actual Weight Reading: 200.0014
 Expected Weight Reading: 200.0000
 Delta Weight (d): 0.0014
 Delta weight in Digits: -14

Recalibrate using internal calibration. After calibration, place the certified mass on the pan and see if the mass agrees with the displayed value. If not, repeat procedure until internal calibration reading agrees with the certified mass.

Span Calibration:

Span calibration utilizes two calibration points, one at zero load and the other at specified full span. See following table.

CALIBRATION MASSES

CAPACITY	LINEARITY MASSES	SPAN ONLY MASSES
62 g	20g/50 g	50 g
162 g	50g/150 g	150 g
110 g	50g/100 g	100 g
210 g	100g/200 g	200 g
410 g	200g/400 g	400 g
510g/610 g	200g/500 g	500 g
1550 g	500g/1500 g	1500 g
2100 g	1000g/2000 g	2000 g
4100 g	2000g/4000 g	4000 g
6100 g	2000g/5000 g	5000 g
8100 g	4000g/8000 g	8000 g

It is recommended that masses must meet or exceed ASTM Class 1 Tolerance. Calibration masses are available as accessories.

Additional calibration values to be used are shown on the display screen. The best accuracy is achieved using the mass closest to the full span value. After calibration, the display returns to the last application mode.

Linearity Calibration:

Linearity calibration utilizes three calibration points, one at zero load and two at specified calibration masses. This method minimizes deviation between actual and displayed weights within the balance's weighing range. After calibration, the display returns to the last application mode.

User Calibration:

User calibration is used when it is desired to calibrate the balance using a user defined mass. The user defined mass value has to be entered in the User Cal Weight. After calibration, the display returns to the last application mode.

User Calibration Weight: 25%-100% of capacity (default is Span)

Defines the mass value for User calibration. The user calibration may now be done with the mass selected.

Cal Test:

Calibration test feature allows a check of a known calibration mass against the last stored calibration information in the balance.

The display indicates the difference in weight between calibration mass placed on the pan and the previous weight value which was stored in the balance. After Cal Test, the display returns to the last application mode.

3.5.2 Balance Options

Press the **Menu** button, and select Balance Options.

Press the **Enter** button. The BALANCE OPTIONS screen is displayed.

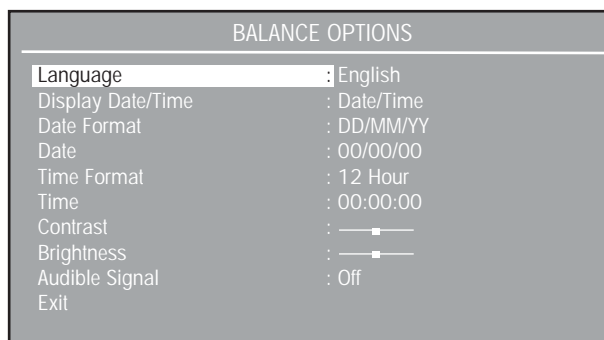

Languages: English, Spanish, etc...(default is English)
 Allows the selection of English, Spanish, French, German or Italian as the operating language to be displayed.

Display Date/Time: Time, date, etc...(default is Date/Time)
 Allows display selection of Time, Date, Date/Time or Off in the upper right-hand corner of the Application Mode screen.

Date Format: MM/DD/YY, YY/MM/DD, ETC...(default is MM/DD/YY)
 Allows setting of one of six date formats: MM/DD/YY, YY/MM/DD, DD/MM/YY, DD/YY/MM, MM/YY/DD or YY/DD/MM.

Date: 00/00/00 (default is none)
 Allows setting the present date.

Time Format: 12 Hour, 24 hour(default is 12 Hour)
 Allows setting the time format of either 12 hours or 24 hours.

Time: 00:00:00 (default is none)
 Allows setting the present time of hours, minutes and AM/PM. Valid numbers change with time format from 1->12 to 0->23. When in 24 hour mode, no AM/PM flag appears.

Contrast:
 Allows adjusting the contrast level of the display.

Brightness:
 Allows adjusting the brightness level of the display.

Audible Signal: On, Off (default is Off)
 With audible signal set On, each button press will generate a tone.

Exit:
 When selected, returns to previous screen.

3.5.3 Readout

Press the **Menu** button, and select Readout.

Press the **Enter** button. The READOUT screen is displayed.

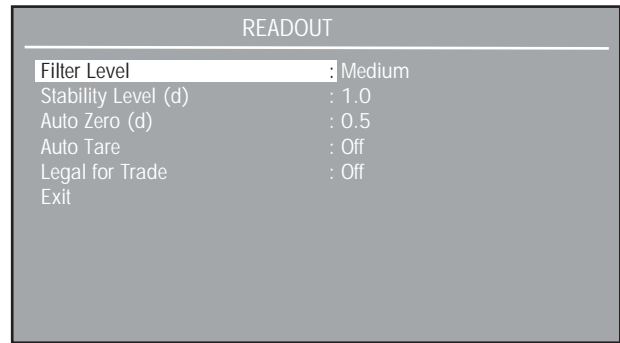

Filter Level: Low, Medium, High (default is Medium)
 Sets the balance reading averaging level to a value of Low, Medium or High. A higher filter level will provide a more repeatable measurement.

Stability Level: 0.5, 1.0, etc... (default is 1.0)
 Sets the balance stability level for the stability indicator to either 0.5, 1.0, 2.0 or 5.0. A 0.5 setting is equivalent to end result of .5 display digit. A 5.0 setting is equivalent to end result of 5 display digits.

Auto Zero: Off, 0.5, etc... (default is 0.5)
 Sets the balance auto zero level to either Off, 0.5, 1.0, 2.0 or 5.0. Auto Zero tracking compensates for the drift at zero load. 0.5d means 0.5 display digit drift compensation per second. 5.0d means 5 display digit drift compensation per second.

Auto Tare: On, Off (default is Off)
 Sets the Auto Tare function to On or Off. This feature provides auto tare in all application modes. When Auto Tare is On, the balance waits for the container/load to be placed on the pan and automatically tares it. This function is repeated for each new container/load.

Legal for Trade: On, Off (default is Off)
 Sets the Legal for Trade (LFT) function either On or Off. Refer to paragraph 3.5.11 for additional information.

3.5.4 Application Modes

Press the **Menu** button, and select Application Modes.

Press the **Enter** button APPLICATION MODES screen is displayed.

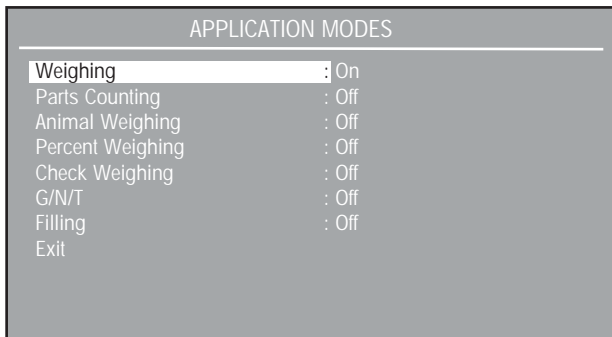

All application modes are displayed on this screen. Each mode may be set on or off. These modes are cycled through when the **Mode** button is pressed.

3.5.5 Units

Press the **Menu** button, and select Units. The UNITS screen is displayed and displays a list of the available weighing units. Depending on the model, some units are not available.

In some models, the number of units contained in the balance exceeds the screen capacity. In order to view all units, the down arrow must be pressed repeatedly to view all available units.

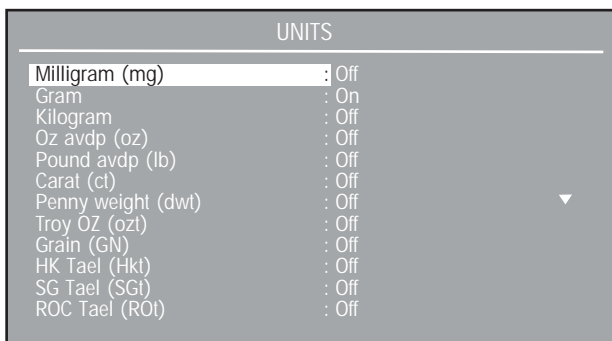

Scroll down using arrow button to view remaining units.

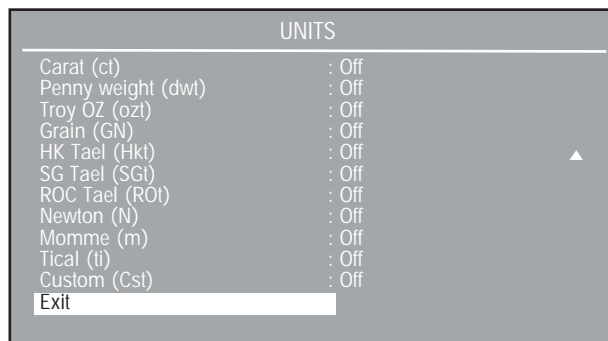

Milligram (mg): On, Off (default is Off)

Unit (mg) = g x 1000, displayed readability by 1.

Gram (mg): On, Off (default is On)

Unit (g) = g x 1, displayed readability by 1.

Kilogram (kg): On, Off (default is Off)

Unit (kg) = g x .001, displayed readability by 1.

OZ avdp (oz): On, Off (default is Off)

Unit Ounces (oz) = g x .002204623, displayed readability by 5.

Pound avdp (lb): On, Off (default is Off)

Unit Pounds (lb) = g x .03527396, displayed readability by 5.

Carats (ct): On, Off (default is Off)

Unit (ct) = g x 5, displayed readability by 5.

Pennyweight (dwt): On, Off (default is Off)

Unit (dwt) = g x .6430149, displayed readability by 1.

Troy OZ (ozt): On, Off (default is Off)

Unit (ozt) = g x .03215075, displayed readability by 5.

Grain (GN): On, Off (default is Off)

Unit (GN) = g x 15.43236, displayed readability by 2.

Hong Kong Tael (Hkt): On, Off (default is Off)

Unit (Hkt) = g x 0.02671725, displayed readability by 5.

Singapore Tael (SGt): On, Off (default is Off)

Unit (SGt) = g x 0.02645547, displayed readability by 5.

ROC Tael (ROt): On, Off (default is Off)

Unit (ROt) = g x 0.02666667, displayed readability by 5.

Newton (N): On, Off (default is Off)

Unit (N) = g x 0.00980665, displayed readability by 1.

MOMME (m): On, Off (default is Off)

Unit (m) = g x 0.2666667, displayed readability by 5.

Tical (ti): On, Off (default is Off)

Unit (ti) = g x 0.0612395, displayed readability by 1.

Custom Unit (Cst): On, Off (default is Off)

When the Custom Unit is set On, the CUSTOM UNIT screen will appear.

This feature can be used to create a custom weighing unit. It permits entering a conversion factor which the balance will use to convert grams to the desired unit of measure.

$$\text{Conversion Factor} \times \text{Grams} = \text{Custom Unit}$$

Unit (Cst) = g x user set custom factor, displayed resolution can not exceed resolution in gram.

Conversion factors are expressed in scientific notation and entered into the balance in three parts:

- Mantissa (0.1 and 1.999999)
- Exponent (10^E)
- Least Significant Digit (LSD)

CUSTOM UNIT	
Factor	: 1.0
Exponents	: E1
LSD	: 1
Exit	

SCIENTIFIC NOTATION				
Conv. Factor	Mantissa Between 0.1 and 1.999999	Exponent	Mantissa	Exp. (10 ^E)
123.4	= .1234 x 1000	=	.1234	x 10 ³
12.34	= .1234 x 100	=	.1234	x 10 ²
1.234	= .1234 x 10	=	.1234	x 10 ¹
.1234	= .1234 x 1	=	.1234	x 10 ⁰
.01234	= .1234 x .1	=	.1234	x 10 ⁻¹
.001234	= .1234 x .01	=	.1234	x 10 ⁻²
.000123	= .123 x .001	=	.123	x 10 ⁻³

EXPONENTS	
E-3	Moves decimal point 3 places to the left.
E-2	Moves decimal point 2 places to the left.
E-1	Moves decimal point 1 place to the left.
E0	Leaves decimal point in normal position.
E1	Moves decimal point 1 place to the right.
E2	Moves decimal point 2 places to the right.
E3	Moves decimal point 3 places to the right.

LSD's	
LSD .5	Adds one decimal place display counts by 5's.
LSD 1	Display counts by 1's.
LSD 2	Display counts by 2's.
LSD 5	Display counts by 5's.
LSD 10	Display counts by 10's.
LSD 100	Display counts by 100's.

3.5.6 Interface

Press the **Menu** button, and select Interface.

Press the **Enter** button, The INTERFACE screen is displayed.

INTERFACE	
Baud Rate	: 2400
Parity	: None
Data Bits	: 7
Stop Bits	: 2
Exit	

Baud Rate: 300, 1200, etc... (default is 2400)
Baud Rate is selectable between 300, 1200, 2400, 4800 or 9600 BPS.

Parity Bit: None, Odd, Even (default is None)
Parity Bit is selectable between None, Odd or Even.

Data Bits: 7, 8 (default is 7)
Data Bits is selectable between 7 or 8 data bits.

Stop Bits: 1, 2 (default is 2)
Stop Bits is selectable between 1 or 2 stop bits.

Exit:
Will return to previous display.

Pro

3.5.7 Print Options

Press the **Menu** button, and select Print Options.

Press the **Enter** button PRINT OPTIONS screen is displayed.

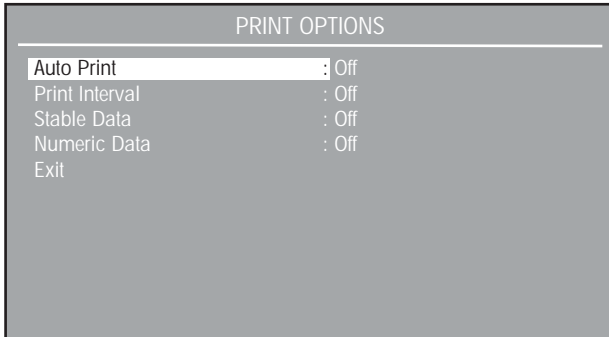

Auto Print: Off, interval, etc... (default is Off)

When enabled, the Auto Print feature causes the balance to automatically output display data in one of three ways: continuously, at user specified time intervals, or upon stability.

- OFF Turns off the auto print feature.
- Interval Provides a user specified printing interval
- Stable Provides printed data each time a stable reading is achieved.
- Continuous Outputs data continuously.

Print Interval: 1-3600 (default is 1)

When Auto Print is set to Interval, a specified printing interval between 1 and 3600 seconds can be set.

Stable Data: Load, Load & Zero (default is Load)

When Auto Print is set to Stable, an option of Load or Load & Zero can be set.

- Load Will print stable load data only.
- Load & Zero Will print stable load data and stable zero data.

Numeric Data: On, Off (default is Off)

When set On, will print numeric data.

3.5.8 GLP Print Options

GLP stands for Good Laboratory Practice. The GLP Print Options enables the printing of a Date & Time, Balance ID, Project Name, User Name, Calibration, Reference, Application Mode and Result lines. Press the Menu button, and select GLP Print Options.

Press the Enter button GLP PRINT OPTIONS screen is displayed.

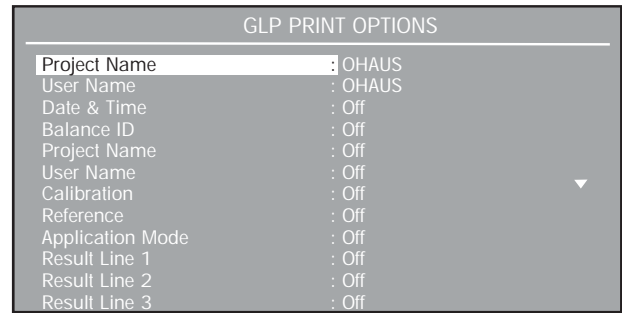

Project Name: (default is OHAUS)

A project name of up to 8 characters may be entered.

User Name: (default is OHAUS)

A user name of up to 8 characters may be entered.

Date & Time: On, Off (default is Off)

When set On, will output date and time.

Balance ID: On, Off (default is Off)

When set On, will output Balance ID.

Project Name: On, Off (default is Off)

When set On, will output project name.

User Name: On, Off (default is Off)

When set On, will output User name.

Calibration: On, Off (default is Off)

When set On, prints out the calibration data after the completion of every calibration process. See sample of span calibration.

SAMPLE PRINTOUT

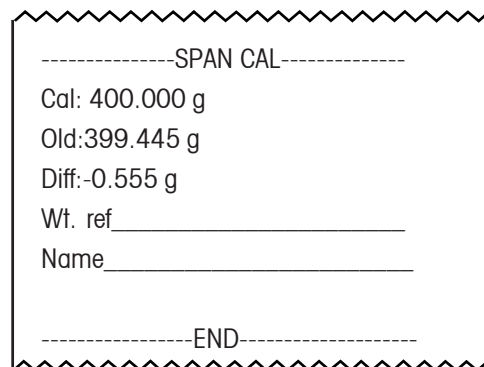

Reference: On, Off (default is Off)

When the Reference function is set ON, it will output the value of weight used as a reference in either Percent Weighing mode or Parts Counting mode.

Application Mode: On, Off (Default is Off)

When set to On, the Application name will be printed during a print operation.

Result Lines: On, Off (Default is Off)

Each of the six Result Lines can be set independently. When set to On, the Result Line information will be printed

Exit:

When selected, returns to previous menu.

3.5.9 Lockout

Provides the capability to lock the Menu settings individually to protect selected parameters against modifications. Locked means the items can be viewed but not changed.

Press the **Menu** button, and select Lockout.

Press the **Enter** button LOCKOUT screen is displayed.

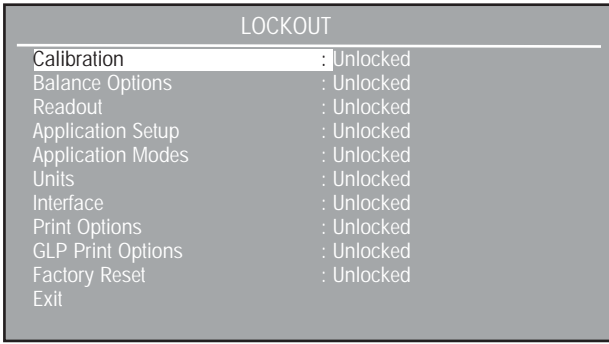

The default setting for all items on the LOCKOUT screen are Unlocked.

3.5.10 Factory Reset

The FACTORY RESET allows parameters to be set to the default values. Each menu item can be reset by setting to Yes. After accepting the changes, the balance will reset the selected menus items. Global Reset will change all menus to a factory setting in one step.

Press the **Menu** button, and select Factory Reset.

Press the **Enter** button FACTORY RESET screen is displayed.

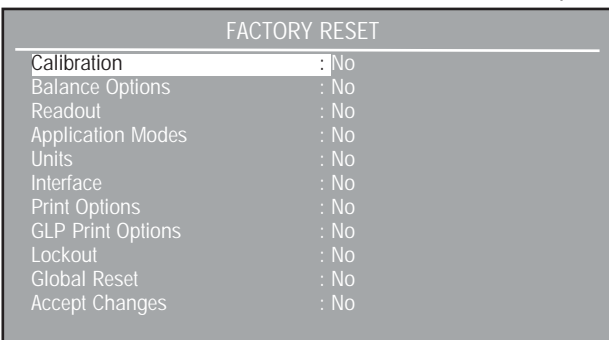

The balance default parameters are listed as follows:

Calibration:

Auto Cal: On (Internal calibration models only)

Autocal delta: 0 (Internal calibration models only)

User Cal weight = Span weight

Balance Options:

Language: English

Display Date/Time: Date/Time

Date Format: MM/DD/YY

Time Format: 12 Hour

Readout:

Filter Level: Medium

Stability Level (d): 1.0

Auto Zero (d): 0.5

Auto Tare: Off

Legal for Trade: Off

Application Modes:

Weighing: On

All others Off

Units:

Grams On, all others Off.

Interface:

Baud Rate: 2400

Parity: None

Data Bits: 7

Stop Bits: 2

Print Options:

Auto Print: Off

Print Interval: Off

Stable Data: Off

Numeric Data: Off

GLP Print Options:

Balance ID=OHAUS

User Name = OHAUS

All others Off

Lockout:

All Unlocked

Pro

3.5.11 LFT Legal for Trade

Legal for Trade (LFT) is a software controlled option which can be set ON in the Readout menu. When LFT is set ON, certain items in the Calibration, Readout and Print menus are automatically preset and locked to permit the balance to operate in a legal for trade application and works in conjunction with a Lockswitch. Default setting is OFF. See default table.

LFT DEFAULT TABLE

LFT and Lockswitch	Default Value
Balance Menu	
Readout	
Stability Level	Locked to 1
Auto Zero	Limited to OFF & 0.5
Auto Cal	
Print Current Settings	Balance will only output stable data

When the balance is first turned ON and LFT has been previously set ON, the initial display will indicate that LFT is ON.

The last digit on the weighing display will be highlighted in white and is used to indicate the auxiliary digit.

Depending upon country regulations, additional settings will have to be locked. Before sealing the balance, check with your local Weights and Measure official.

3.5.12 Hardware Lockswitch

Access to the various menus can be disabled setting the Lockswitch located on the PC board inside the balance to locked position. The Lockswitch locks out all menus which have been set to LOCKED. The default setting for the Lockswitch is UNLOCKED.

3.5.13 Sealing the Balance

“Certified balances have a securing sticker and additional labeling applied at the factory. When subsequent verification is carried out, they can be sealed either with a lead seal and wire, or with a new securing sticker”.

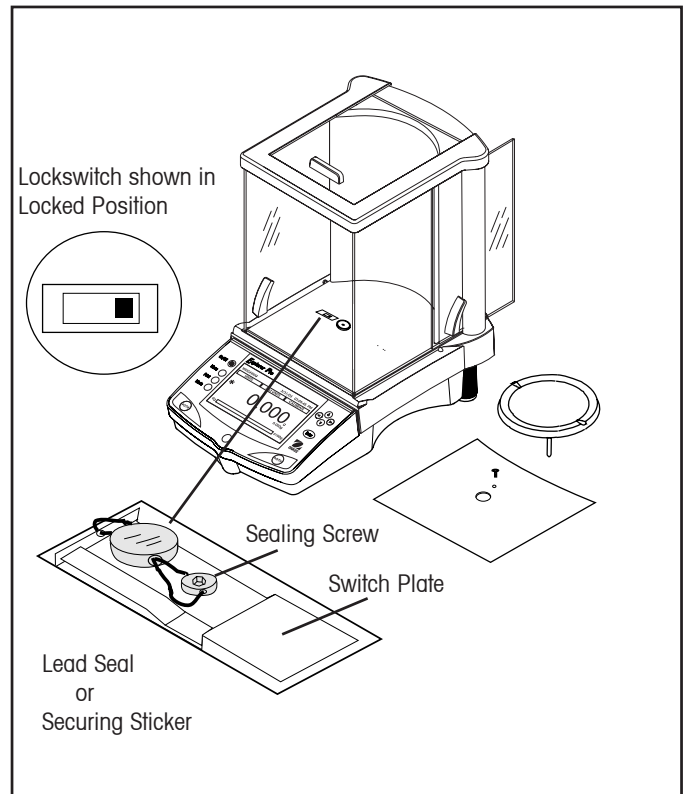

Example of Sealing Method

3.6 Printing Data

Printing data requires that the Interface menu, Print Options and GLP Print Options are set properly.

Pressing the **Print** button will initiate printing each time it is pressed.

Sample printout is shown below with GLP Options turned on.

SAMPLE PRINTOUT

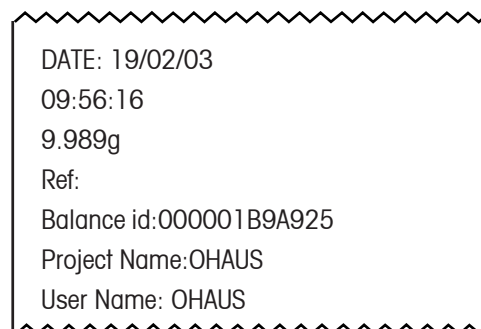

4. CARE AND MAINTENANCE

4.1 Cleaning

To keep the balance operating properly, the housing and pan should be kept clean and free from foreign material. If necessary, a cloth dampened with a mild detergent may be used. Keep calibration masses in a safe dry place.

4.2 Troubleshooting

SYMPTOM	PROBABLE CAUSE(S)	REMEDY
Unit will not turn on.	Power cord not plugged in or properly connected to balance.	Check power cord connections.
Incorrect weight reading.	Balance was not tared before weighing. Balance out of level. Balance not properly calibrated.	Press >O/T< with no weight on the pan, then weigh item. Adjust leveling feet. Recalibrate correctly.
Cannot display weight in desired unit.	Desired unit not enabled.	Enable units in Units menu.
Cannot access desired application.	Desired application mode is not enabled.	Enable desired application in Application Modes menu.
Unable to change menu settings.	Menu locked.	Verify that Lockswitch is in the Off position, unlock menu in the Lockout menu.
RS232 interface not working.	Interface parameters not properly set up. Incorrect cable being used. Cable connections.	Verify interface settings in RS232 menu correspond to those of peripheral device. Refer to Accessory list for proper cable. Check cable connections are installed properly. Check correct cable end is plugged into the balance.
Unstable readings.	Vibration on table surface.	Check environmental conditions. Close draft shield doors. Change averaging level to a higher setting or place balance on a stable surface
Error message display.	_____	See Error Codes list.
Incorrect calibration	Balance not tared. Internal calibration not adjusted properly.	Tare the balance. Perform calibration adjustments.

Pro

4.3 Error Codes List

Error Codes List

The following list describes the various error codes that can appear on the display and the suggested remedy.

Data Errors

- 1.0 Transient error (hardware error, probably static discharge). If error persists, the balance must be serviced.
- 1.1 Balance temperature transducer hardware error.
- 1.2 No data from main board.

Tare Errors

- 2.0 Balance is unable to stabilize within time limit after taring. Environment is too hostile or balance needs recalibration.

Calibration Errors

- 3.0 Incorrect or no calibration mass used for calibration. Recalibrate with correct masses.

RS232 Errors

- 4.4 RS232 buffer is full.

User Errors

- 7.0 User entry out of bounds.
- 7.2 Number outside of display capacity.

Over-Under Load Errors

- 8.0 Hardware error causing an internal weight signal which is too low. Check if pan is off. If not, the balance must be serviced.
- 8.1 Hardware error caused by an internal weight signal which is too high. Check load on the pan which may be excessive. If error persists, the balance must be serviced.
- 8.2 Power-on load out of specification (LFT only)
- 8.3 Rated capacity exceeded. Remove excessive weight from pan.
- 8.4 Underload condition on balance. Check that the proper pan is installed.
- 8.5 Auto Cal weight internal sensor indicated its weight on the pan.

Checksum Errors

- 9.1 Bad factory checksum. If error persists, have the balance serviced.
- 9.2 Bad factory checksum. If error persists, have the balance serviced.
- 9.3 Bad factory checksum. If error persists, have the balance serviced.
- 9.4 Auto Cal data failed checksum. This failure will disable access to the Auto Cal feature (if installed).
- 9.5 Factory calibration data failed checksum.
- 9.6 Bad program checksum.
- 9.7 Bad CMOS checksum.
- 9.8 User calibration data failed checksum.
- 9.9 Factory temperature compensation data failed checksum.

4.4 Service Information

If the Troubleshooting section does not resolve or describe your problem, you will need to contact an authorized Ohaus Service Agent. For Service assistance in the United States, please call Aftermarket, Ohaus Corporation toll-free at (800) 526-0659. An Ohaus Product Service Specialist will be available to help you. Global contact addresses and phone numbers are accessible on www.ohaus.com.

4.5 Replacement Parts

<u>Description</u>	<u>U.S. Part No.</u>	<u>Global Part No.</u>
Power Pack, 100/120 V ac US Plug (Cord set part of power pack)	490202-010	21202536
Power Pack, (Cord set required for UK, European and Australian)	490203-010	21202537
Cord Set, 230 V ac, UK Plug	76448-00	89405
Cord Set, 230 V ac, European Plug	76212-00	87925
Cord Set, 230 V ac, Australian plug	76199-01	88751
In-Use Display Cover Kit		80850042

4.6 Accessories

Description

Calibration Masses - ASTM Class 1 Tolerance:

20 g	49024-11	80780022
50 g	49054-11	80730028
100 g	49015-11	80780020
200 g	49025-11	80780023
500 g	49055-11	80780029
1 kg	49016-11	80780021
2 kg	49026-11	80780024
4 kg	49046-11	80780027
Security Device	470004-01	80850043
Density Determination Kit	470007-01	80850045
Auxiliary Display Kit (Table Mount)	470009-01	80850048
RS232 Interface Cable, Blunt end (user defined)	AS017-01	80850013
RS232 Interface Cable, IBM® - PC 25 Pin	AS017-02	80850014
RS232 Interface Cable, (connects impact printer)		80500570
RS232 Interface Cable, IBM® - PC 9 Pin	AS017-09	80850015
RS232 Interface Cable, Apple® IIGS/Macintosh	AS017-10	80850072
Printer		SF42
Printer Cable		80500570

Pro

5. TECHNICAL DATA

5.1 RS232 Commands

Command Character	Description										
C	Begin span calibration										
xD	Set 1 second print delay (set x = 0 for OFF, or x = 1 for ON)										
PM	Application mode.										
xFL	Set Averaging Filter Level 1= Low, 2= Medium, 3= High										
L	Begin linearity calibration										
P	Print displayed weight (stable or unstable) Field: <table border="1" style="display: inline-table; vertical-align: middle;"> <tr> <td>Weight</td> <td>Unit</td> <td>Stab</td> <td>CR</td> <td>LF</td> </tr> <tr> <td>Max 9</td> <td>5</td> <td>1</td> <td>1</td> <td>1</td> </tr> </table> Length:	Weight	Unit	Stab	CR	LF	Max 9	5	1	1	1
Weight	Unit	Stab	CR	LF							
Max 9	5	1	1	1							
T	Same as pressing Tare key.										
PV	Version: print name, software revision and LFT ON (if LFT is set ON)										
xAL	Set Auto-Zero level to x. x = 0 for OFF, x = 1 for 0.5d, x=2 for 1.0d, x=3 for 2.0d, x=4 for 5.0d.										
Esc R	Resets Setup and Print menus to factory defaults										
On	Turns balance on										
Off	Turns balance off										
x%	Set % reference weight (x) in current unit										
x#	Set PC reference weight (x) in current unit										
P#	Print PC reference weight										
P%	Print percent reference weight										
xM	Set current Application mode to x. x = 1 for Weighing, x = 2 for Parts Counting, x = 3 for Animal Weighing, x = 4 for Percent Weighing, x = 5 for Check Weighing, x = 6 for G/N/T, x = 7 for Filling										
xAW	Set Animal Weigh Level to x. x = 1 for LOW, x = 2 for MEDIUM, x = 3 for HIGH.										
xAM	Set animal mode. Where x is 1=Manual, 2=Semi and 3=Auto										
SAW	Start Animal cycle.										
xT	Download Tare value in current unit. Sending OT clears tare.										
PID	Print current user ID string										
xID	Program user ID string. 1-8 characters										
AC	Abort calibration										
xUC	Set user defined weight										
UC	Initiate user calibration										
IC	Initiate internal calibration										
PTIME	Print current time										
mm/dd/yyDATE	Set date										
hh:mm:ssTIME	Set time										
PDATE	Print current date										

5.2 Specifications

Admissible Ambient Conditions

	Use only in closed rooms
Ambient Temperature range:	5 °C to 40 °C
Atmospheric humidity:	80% rh @ to 30 °C
Voltage fluctuations:	-15% +10%
Installation category:	II
Pollution degree:	2
Power supply voltage:	12 VAC, 50/60 Hz or 12 VDC, 1A

Analytical Balances

Capacity (g)	62	110	210	100/210 *
Readability (mg)	0.1			0.1/1
Repeatability (Std. dev.) (mg)	0.1			0.1/0.5
Linearity (mg)	(±) 0.2			(±) 0.2/0.5
Weighing units ***	gram, milligram, ounce, ounce troy, carat, pennyweight, Hong Kong Tael, Singapore Tael, Taiwan Tael, mommes, grain, tical, Newton, custom			
Application modes	Weighing, Parts Counting, Animal Weighing, Check Weighing, Percent Weighing, Filling, Gross-Net-Tare Weighing			
Features	RS232 Port, Auxillary Display Port, GLP Protocol, Selectable Language, Display Text, Selectable Displayed Information Settings, Selectable Environmental Settings, Selectable Auto-Print Settings, Integral Weigh Below Hook, Contrast and Brightness Control, Protective In-Use cover			
Tare range	Full capacity by subtraction			
Stabilization time (s)	4			
Calibration	External / Internal			
Display Type	LCD Dot Matrix w/CCFL Backlight			
Display Size (in/cm)	2.5 x 4.7 / 64 x 120			
Operating temperature range:	Non LFT w/internal calibration 10°C to 40° C / 50°F to 104° F w/o internal calibration 10°C to 30°C / 50°F to 86° F			
Power requirements	External Adapter, 100 -120 VAC 150mA, 220 - 240 VAC 100mA, 50/60 Hz Plug configuration for US, Euro, UK, Japan & Australia			
Draft shield (in/cm) (free height above platform)	10.2/25.9			
Pan size (in/cm)	3.5 / 9. diameter			
Dimensions (WxHxD) (in/cm)	8.5 x 13.5 x 14.5 / 21.5 x 35.5 x 37			
Net Weight (lb/kg)	12.5 / 5.7			
Net Weight (lb/kg) InCal Models	14.8 / 6.7			

* Moveable FineRange™

*** Units availability is country dependent.

Pro**Precision Balances**

Capacity (g)	210	410	510	610	100/410*	610	1500	2100	4100	6100	1000/4100*	4100**	6100**	8100**
Readability (g)	0.001				0.001/0.01		0.01			0.01/0.1		0.1		
Repeatability (Std. dev.) (g)	0.0005	0.0015		0.0005/0.005		0.005			0.01	0.01/0.05		0.05		
Linearity (g)	(±)0.002			(±)0.002/0.005			(±)0.02		(±)0.04	(±)0.02/0.05		(±)0.1		
Weighing units***	gram, milligram, kilogram, pound, ounce, ounce troy, carat, pennyweight, Hong Kong Tael, Singapore Tael, Taiwan Tael, mommes, grain, tical, Newton, custom													
Application modes	Weighing, Parts Counting, Animal Weighing, Check Weighing, Percent Weighing, Filling, Gross-Net-Tare Weighing													
Features	RS232 Port, Auxillary Display Port, GLP Protocol, Selectable Language, Display Text, Selectable Displayed Information Settings, Selectable Environmental Settings, Selectable Auto-Print Settings, Integral Weigh Below Hook, Contrast and Brightness Control, Protective In-Use cover													
Tare range	Full capacity by subtraction													
Stabilization time (s)	3													
Operating temperature range:	Non LFT w/internal calibration 10°C to 40°C / 50°F to 104° F All others 10°C to 30°C / 50°F to 86°F													
Calibration	External / Internal													
Power requirements	External Adapter, 100 -120 VAC 150mA, 220 - 240 VAC 100mA, 50/60 Hz Plug configuration for US, Euro, UK, Japan & Australia													
Draft shield (in/cm) (free height above platform)	10.2/25.9						None							
Display Type	LCD Dot Matrix w/CCFL Backlight													
Display size (in/mm)	2.5 x 4.7 / 64 x 120													
Pan size (in/cm)	4.7/12 Dia.						6.8 x 6.8/17.2 x 17.2 w/windshield						8 x 8/ 20.3 x 20.3 **	
Dimensions (WxHxD) (in/cm)	8.5x13.5x14.5/21.5x35.5x37													
Net Weight (lb/kg)	12.5 / 5.7				8.4 / 3.8				10/4.5	8.4 / 3.8		10 / 4.5		
Net Weight (lb/kg) InCal Models	14.8 / 6.7				10 / 4.5				15.5/7	10/4.5		15.5/7		

* Moveable FineRange™

** Balances with Auto Cal are equipped with a 6.8 in. x 6.8 in. / 17.2 cm x 17.2 cm Pan and Windshield.

*** Units availability is country dependent.

LIMITED WARRANTY

Ohaus products are warranted against defects in materials and workmanship from the date of delivery through the duration of the warranty period. During the warranty period Ohaus will repair, or, at its option, replace any component(s) that proves to be defective at no charge, provided that the product is returned, freight prepaid, to Ohaus.

This warranty does not apply if the product has been damaged by accident or misuse, exposed to radioactive or corrosive materials, has foreign material penetrating to the inside of the product, or as a result of service or modification by other than Ohaus. In lieu of a properly returned warranty registration card, the warranty period shall begin on the date of shipment to the authorized dealer. No other express or implied warranty is given by Ohaus Corporation. Ohaus Corporation shall not be liable for any consequential damages.

As warranty legislation differs from state to state and country to country, please contact Ohaus or your local Ohaus dealer for further details.

Index

A

AC Adapter Installation 6
Accessories 33
Admissible Ambient Conditions 35
Admissible ambient conditions 35
Ambient Temperature rang 35
Analytical Balances 35
Animal Weighing 19
Application Modes 26
Applications 12
APW 14, 16
Atmospheric humidity 35
Audible Signal 25
Auto Print 28
Auto Tare 25
Auto Zero 25
AutoCal 23
AutoCal Delta 23
Average Piece Weight 13

B

Balance ID 28
Balance Location 5
Balance Options 24
Balance Settings 23
Baud Rate 27
Brightness 25

C

Cal Test 24
CALIBRATE 13, 20
Calibrating from the Weighing Screen 7
Calibration 23, 28, 29
CALIBRATION MASSES 7, 24
Calibration Masses 7
Cannot access desired application 31
Cannot display weight in desired unit 31
CAPACITY 7
Capacity 35
CARE AND MAINTENANCE 31
CHECK WEIGHING 20
Check Weighing 20
Cleaning 31
Connecting Power and Communications 6
Contrast 25
Cord Set 33
Custom Unit (Cst) 27

D

Data Bits 27
Date 25
Date & Time 28

Date Format 25
Density Determination Kit 33
Description 3
Display Date/Time 25

E

Error Codes List 32
Error message display 31
Example of Sealing Method 30
EXPONENTS 27

F

Factory Reset 29
Features 3
FILLING 22
Filling 22
FILTER 20
Filter Level 25

G

G/N/T WEIGHING 21
Global Part No. 33
GLP Print Options 28
Gross / Net / Tare Weighing 21

H

Hardware 6
Hardware Lockswitch 30

I

In-Use Display Cover Kit 33
Incorrect calibration 31
Incorrect weight reading 31
Initial Calibration 7
INSTALLATION 3
Installation category 35
Installing Components 4
Interface 27
Internal Calibration 23
INTRODUCTION 3

L

Languages 25
LCD Display 9
Lead Seal 30
Legal for Trade 25
Leveling the Balance 5
LFT DEFAULT TABLE 30
LFT Legal for Trade 30
LIMITED WARRANTY 37
Linearity Calibration 24
Lockout 29

Pro

Index

M

Menu 11
Menu Structure 11

N

Navigation 11
NEW COUNT 13
New Count Key 14
NEW REF 18
Numeric Data 28

O

OPERATION 8
Output Formats 6
Overview of Controls 8
Overview of Display Indicator 10

P

Parity Bit 27
PARTS COUNTING 13
Parts Counting 13
PARTS COUNTING-CHECK 15
PARTS COUNTING-FILL 16
PC CHECK 15
PC FILLING 16
PERCENT WEIGHING 17, 18
Percent Weighing 17
Platform Installation 4
Pollution degree 35
Power On/Off 11
Power Pack 33
Power supply voltage 35
Precision Balances 36
Print Interval 28
Print Options 28
Printer 33
Printer Cable 33
Printing Data 30
Project Name 28

R

Rear of Balance 6
REFERENCE 18
Reference 28
Replacement Parts 33
Replacement parts 33
RS232 Commands 34
RS232 Interface 6
RS232 Interface Cable 33
RS232 interface not working 31

S

Safety Precautions 3
SAMPLE PRINTOUT 30
SAMPLE SIZE 13
SAMPLE SIZE/APW 14, 16, 17
SCIENTIFIC NOTATION 27
Sealing Screw 30
Sealing the Balance 30
Security Device 33
Selecting the Location 5
Service Information 33
SETUP 13
Size/APW Key 14
Span Calibration 24
Specifications 35
Stability Level 25
Stabilization 11
Stable Data 28
Stop Bits 27
Switch Plate 30

T

TECHNICAL DATA 34
Time 25
Time Format 25
Troubleshooting 31
Turning on the Balance 11

U

U.S. Part No. 33
Unable to change menu settings 31
Unit will not turn on 31
Units 26
Unpacking 3
Unstable readings 31
User Calibration 24
User Calibration Weight 24
User Name 28

V

Voltage fluctuations 35

W

Warranty 36
Weigh Below Preparation 4
Weighing 12
Weighing with a Container 12
Windshield Installation 4

Z

Zero the balance 12



Ohaus Corporation
19A Chapin Road,
P.O. Box 2033
Pine Brook, NJ 07058, USA
Tel: (973) 377-9000,
Fax: (973) 593-0359

With offices worldwide.
www.ohaus.com



* 8 0 2 5 0 9 5 5 *

PN 80250955 B © Ohaus Corporation 2003 all rights reserved.