

GP SERIES

GP-12K/GP-20K /GP-30K/GP-32K

GP-40K/GP-60K/GP-61K

GP-100K/GP-102K

GP-30KS/GP-32KS

GP-60KS/ GP-61KS/GP-100KS

Precision Balance

INSTRUCTION MANUAL

AND

A&D Company, Ltd.

1WMPD4000273F

© 2014 A&D Company Ltd. All rights reserved.

No part of this publication may be reproduced, transmitted, transcribed, or translated into any language in any form by any means without the written permission of A&D Company Ltd.

The contents of this manual and the specifications of the instrument covered by this manual are subject to change for improvement without notice.

CONTENTS

Basic Operation

1. INTRODUCTION	5
1-1 About This Manual	5
1-2 Features	5
1-3 Compliance	6
2. UNPACKING THE BALANCE	7
2-1 Unpacking	7
2-2 Installing the Balance	8
3. PRECAUTIONS	9
3-1 Before Use	9
3-2 During Use	9
3-3 After Use	10
3-4 Power Supply	10
3-5 Display Symbols and Key Operation	11
3-6 Smart Range Function	12
4. WEIGHING UNITS	13
4-1 Units	13
4-2 Changing the Units	16
5. WEIGHING	17
5-1 Basic Operation (Kilogram Mode)	17
5-2 Counting Mode (PCS)	18
5-3 Percent Mode (%)	20
5-4 Animal Weighing Mode (Hold Function)	20
5-5 Accumulation Function	21
6. RESPONSE ADJUSTMENT / SELF CHECK FUNCTION	23
6-1 Automatic Response Adjustment / Self Check Function	23
6-2 Manual Response Adjustment	24
7. CALIBRATION	25
7-1 Calibration Group	25
7-2 Automatic Self Calibration (Calibration due to changes in temperature)	26
7-3 Calibration Using the Internal mass (One-Touch Calibration)	27
7-4 Calibration Using an External Weight	28
7-5 Calibration Test Using an External Weight	30
7-6 Correcting the Internal Mass Value	32
8. FUNCTION SWITCH AND INITIALIZATION	34
8-1 Permit or Inhibit	34
8-2 Initializing the Balance	35
9. FUNCTION TABLE	36
9-1 Structure and Sequence of the Function Table	36
9-2 Display and Keys	36
9-3 Details of the Function Table	37
9-4 Description of the Class "Environment, Display"	40
9-5 Description of the Item "Data output mode"	42
9-6 Description of the Item "Data format"	43
9-7 Description of the Data Format Added to the Weighing Data	45
9-8 Data Format Examples	46
9-9 Clock and Calendar Function	48

9-10 Comparator Function	50
9-11 Adding the Comparison Results	52
9-12 Main Display Comparison Function	52
10. ID NUMBER AND GLP REPORT	54
10-1 Setting the ID Number.....	54
10-2 GLP Report	55
11. DATA MEMORY	58
11-1 Notes on Using Data Memory	58
11-2 Memory for Weighing Data.....	59
11-3 Memory for Calibration and Calibration Test Data	62
11-4 Memory for Unit Mass in the Counting Mode.....	63
11-5 Memory for Comparator Settings	65
11-6 Memory for Tare Value	67
11-7 Data Memory: Quick Selection Mode.....	71
11-8 Data Memory: Confirmation and Storage Mode.....	72
12. PROGRAMMABLE-UNIT	73
13. DENSITY MEASUREMENT	74
14. I/O UNIT SPECIFICATIONS (Standard)	77
14-1 RS-232C//External Contact Input)	77
15. CONNECTION TO PERIPHERAL EQUIPMENT	79
15-1 Connection to the AD-8127 Multi Printer.....	79
15-2 Connection to a Computer	79
15-3 Using Windows Communication Tools (WinCT)	80
15-4 Using the WinCT software, the balance can do the following:.....	81
16. COMMANDS	82
16-1 Command List.....	82
16-2 Acknowledge Code and Error Codes.....	83
16-3 Control Using CTS and RTS.....	83
16-4 Settings Related to RS-232C.....	83
17. MAINTENANCE	84
18. TROUBLESHOOTING.....	84
18-1 Checking the Balance Performance and Environment.....	84
18-2 Error Codes.....	85
18-3 Asking For Repair.....	87
19. SPECIFICATIONS	88
20. EXTERNAL DIMENSIONS	90
21. OPTIONS.....	92
22. TERMS/INDEX	94

1. INTRODUCTION

This manual describes how the GP series balance works and how to get the most out of it in terms of performance.

Read this manual thoroughly before using the balance and keep it at hand for future reference.

1-1 About This Manual

This manual consists of the following five parts:

- Basic operation Describes precautions on handling the balance, balance construction and basic balance operation.
- Adapting to the environment Describes response adjustment, calibration and calibration test.
- Functions Describes various functions of the balance.
- RS-232C serial interface..... Describes RS-232C serial interface output and external contact input. The RS-232C serial interface outputs weighing data and controls the balance. The external contact input commands the balance re-zeroing and data output.
- Maintenance..... Describes maintenance, error codes, troubleshooting, specifications and options.

1-2 Features

- Large Vacuum Fluorescent Display, easy to read.
- Dust-tight and Protected Against Water Jets (Complying with IP65), allows washing with water.
- Built-in Calibration Weight (hereinafter referred to as internal mass), allows easy calibration, adjustment and maintenance of the balance.
- Automatic Self Calibration, using the internal mass, adapting to changes in temperature.
- Self Check Function, provided to self-check the balance using the internal mass.
- Automatic Response Adjustment, adapting to vibration and drafts in the environment.
- High Response Speed, the time to read a displayed value after a sample is placed on the pan has been shortened by using the Super Hybrid Sensor (SHS). (Approx. 1.5 seconds when **FAST** is selected for the response rate.)
- Data Memory Function, storing weighing data, calibration data or unit mass in the counting mode. It can also store tare values or upper and lower limit values for the comparator function. Interval Memory Mode is provided to store the weighing data periodically.
- Good Laboratory Practice (GLP) data output using the standard RS-232C serial interface.
- Clock and Calendar Function, adding the time and date to the output data.
- Comparator Indicators, displaying the comparison results, **HI**, **OK** or **LO**.
- Capacity Indicator, displaying the weight value in percentage relative to the weighing capacity.

- Hold Function, provided for weighing a moving object such as an animal.
- Multiple Weighing Units, with most of the common units used around the world.
- Density Mode, for calculating the density of a solid.
- Accumulation Function, adding the weight values and outputting the sum.
- Adjustable Display Position, the standard type balance has a swing-arm to adjust the display position for optimum viewing.
Separate display type balances (GP-30KS/32KS/60KS/61KS/100KS) are also available.
- Windows Communication Tools (WinCT), allows easy communication with Windows.
Windows is a registered trademark of Microsoft Corporation.
- Reference Card, provided for a quick reference to the balance operation.
- Underhook, available as an option, for measuring density and weighing magnetic materials.
- Comparator Output (OP-04) and Analog Voltage Output (OP-06) are available as options.

1-3 Compliance

Compliance with FCC Rules

Please note that this equipment generates, uses and can radiate radio frequency energy. This equipment has been tested and has been found to comply with the limits of a Class A computing device pursuant to Subpart J of Part 15 of FCC rules. These rules are designed to provide reasonable protection against interference when equipment is operated in a commercial environment. If this unit is operated in a residential area, it may cause some interference and under these circumstances the user would be required to take, at his own expense, whatever measures are necessary to eliminate the interference.

(FCC = Federal Communications Commission in the U.S.A.)

2. UNPACKING THE BALANCE

2-1 Unpacking

- The balance is a precision instrument. Unpack the balance carefully. Keep the packing material to be used for transporting the balance in the future.
- The packing contents depend on the balance model. See the illustrations to confirm that everything is contained.

Standard type: GP-12K/20K/30K/32K/40K/60K/61K/100K/102K

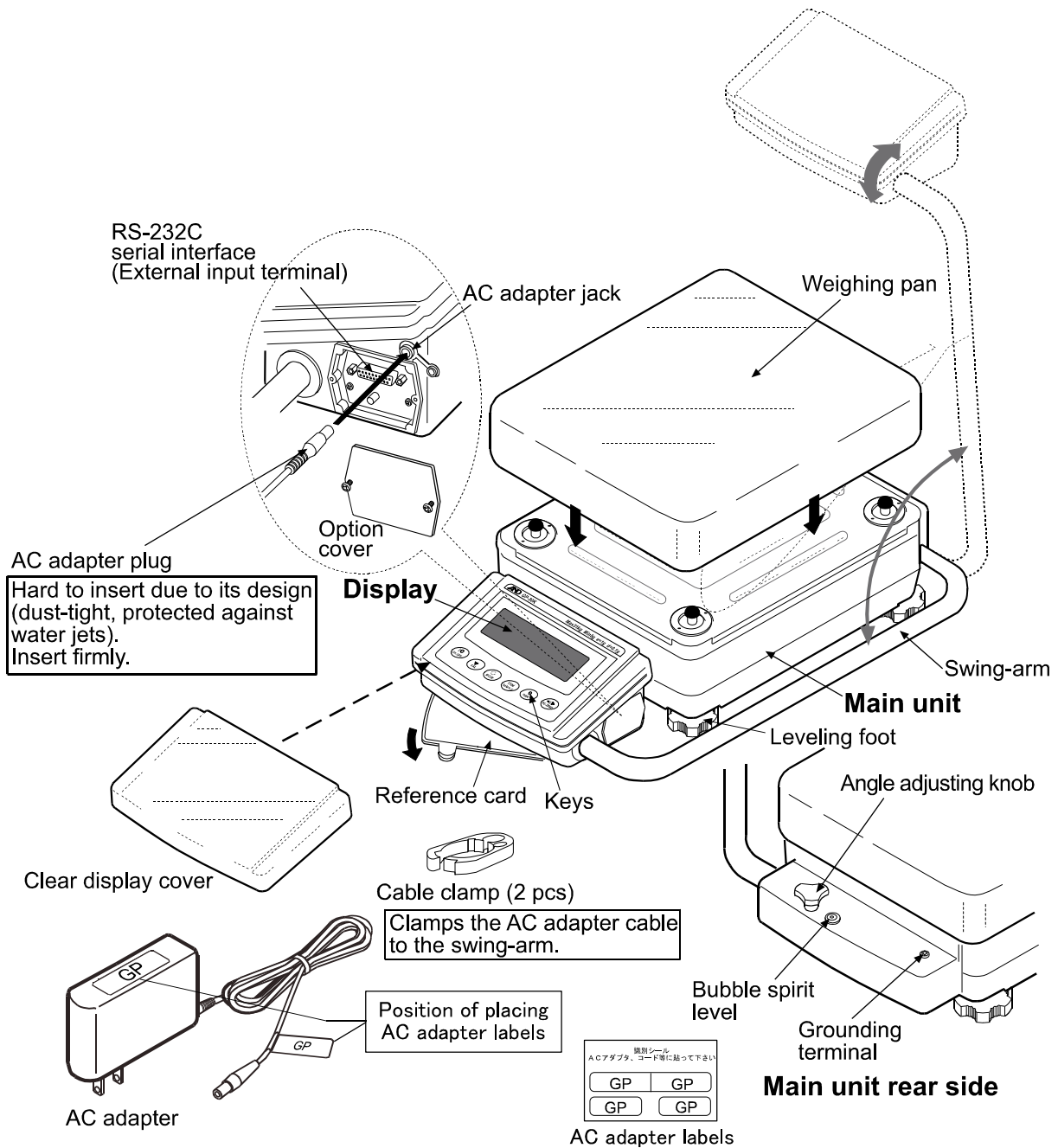

Note

Please confirm that the AC adapter type is correct for your local voltage and receptacle type.

Separate display type: GP-30KS/32KS/60KS/61KS/100KS

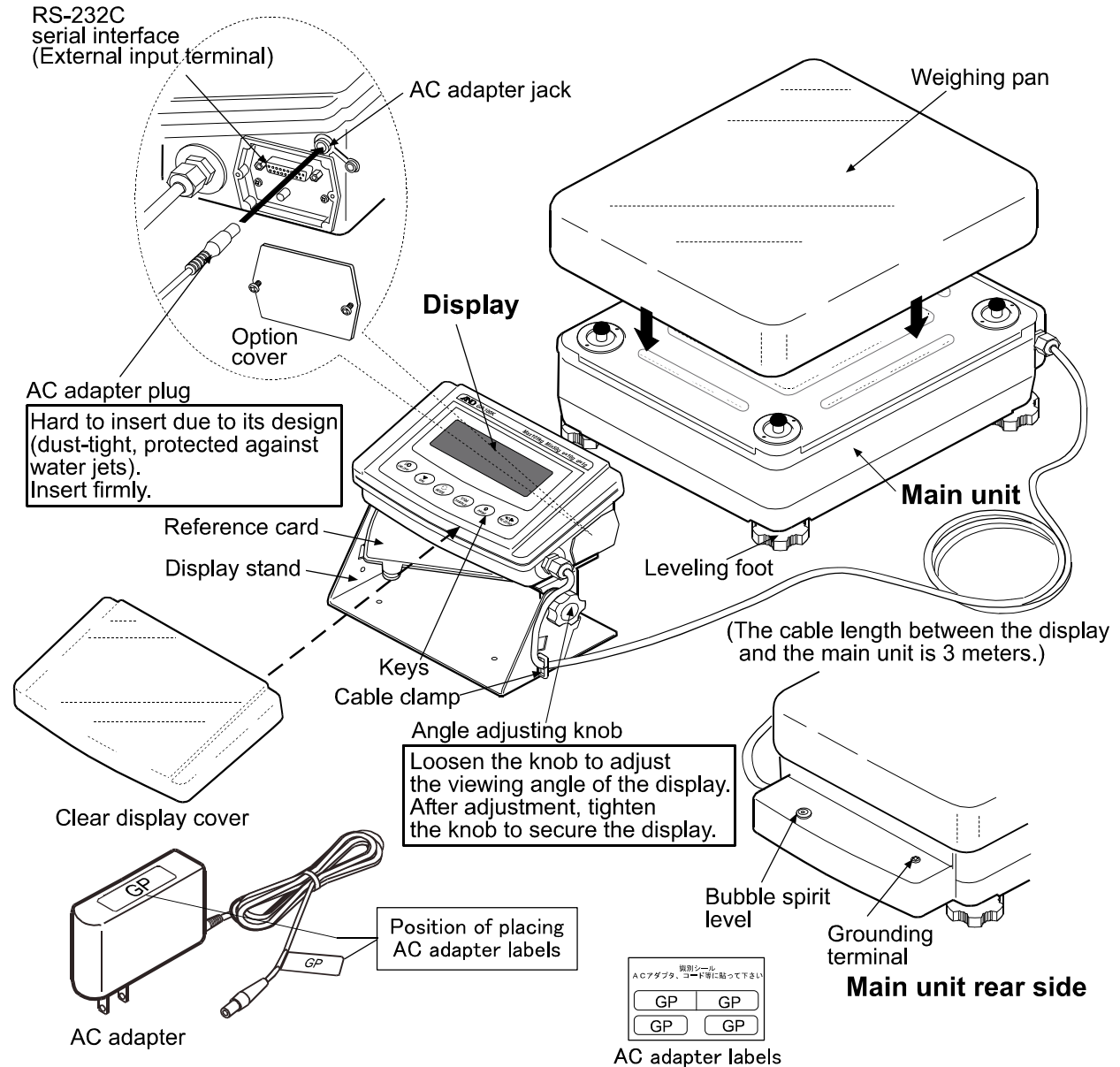

Note

Please confirm that the AC adapter type is correct for your local voltage and receptacle type.

2-2 Installing the Balance

Install the balance as follows:

1. Refer to "3. PRECAUTIONS" for installing the balance.
2. Adjust the leveling feet to level the balance. Confirm it using the bubble spirit level.
3. Confirm that the adapter type is correct for the local voltage and power receptacle type.
4. Connect the AC adapter to the balance. Warm up the balance for at least 30 minutes with nothing on the weighing pan.

3. PRECAUTIONS

To get the optimum performance from the balance and acquire accurate weighing data, note the following:

3-1 Before Use

- Install the balance in an environment where the temperature and humidity are not excessive. The best operating temperature is about 20°C / 68°F at about 50% relative humidity.
- Install the balance where it is not exposed to direct sunlight and it is not affected by heaters or air conditioners.
- Install the balance where it is free of dust.
- Install the balance away from equipment which produces magnetic fields.
- Install the balance in a stable place avoiding vibration and shock. Corners of rooms on the first floor are best, as they are less prone to vibration.
- The weighing table should be solid and free from vibration, drafts and as level as possible.
- Level the balance by adjusting the leveling feet and confirm it using the bubble spirit level.
- Ensure a stable power source when using the AC adapter.
- Plug in the AC adapter and warm up the balance for at least 30 minutes.
- Calibrate the balance periodically for accurate weighing.
- When the balance is installed for the first time or has been moved, warm up the balance for at least 12 hours to allow the balance to reach equilibrium with the ambient temperature, and then perform calibration before use.

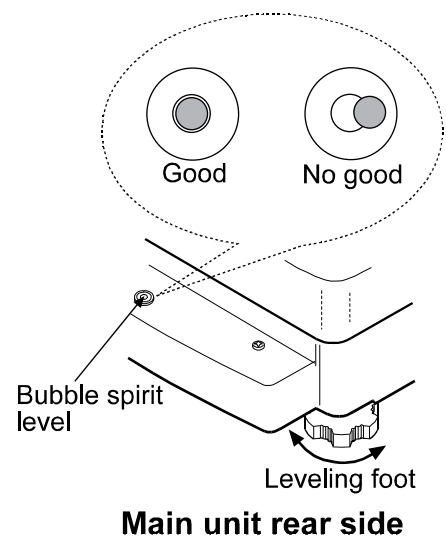

Caution

Please confirm that the AC adapter type is correct for your local voltage and receptacle type. Do not install the balance where flammable or corrosive gas is present.

3-2 During Use

- Discharge static electricity from the material to be weighed (hereinafter referred to as sample). When a sample could have a static charge, the weighing data is influenced. Try to keep the ambient humidity above 45%RH or use the metal shield case.

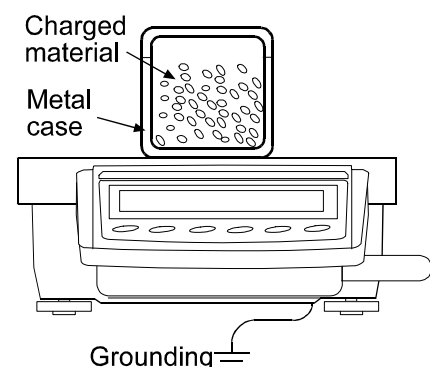

- This balance uses a strong magnet as part of the balance assembly, so please use caution when weighing magnetic materials such as iron. If there is a problem, use the underhook on the bottom of the balance to suspend the material away from the influence of the magnet.
- Cancel the temperature difference between a sample and the environment. When a sample is warmer (cooler) than the ambient temperature, the sample will be lighter (heavier) than the true weight. This error is due to a rising (falling) draft around the sample.
- Make each weighing gently and quickly to avoid errors due to changes in the environmental conditions.
- Do not drop things upon the weighing pan, or place a sample on the pan that is beyond the balance weighing capacity. Place a sample in the center of the weighing pan.
- Do not use a sharp instrument such as a pencil to press the keys. Use your finger only.
- Press the **RE-ZERO** key before each weighing to prevent possible errors.
- Calibrate the balance periodically so as to cancel possible errors.
- Take into consideration the affect of air buoyancy on a sample when more accuracy is required.
- Keep the balance interior free of dust and foreign materials.

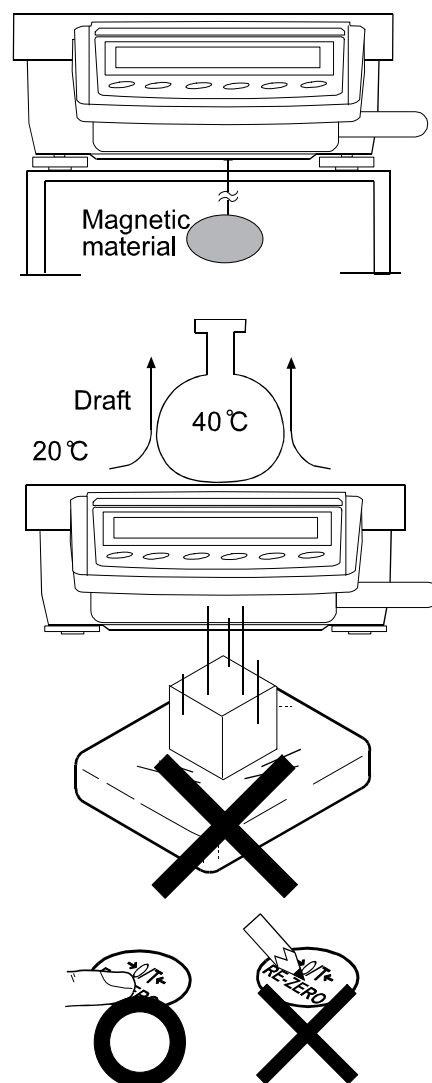

3-3 After Use

- Avoid mechanical shock to the balance.
- Do not disassemble the balance. Contact the local A&D dealer if the balance needs service or repair.
- Do not use organic solvents to clean the balance. Clean the balance with a lint free cloth that is moistened with warm water and a mild detergent.
- Do not allow the balance to be immersed in water. Even though the balance complies with IP65 (Dust-tight and Protected Against Water Jets), the balance will not withstand being completely immersed in water.

3-4 Power Supply

- Do not remove the AC adapter while the internal mass is in motion, for example, right after the AC adapter is connected, or during calibration using the internal mass.
If the AC adapter is removed under the conditions described above, the internal mass will be left unsecured, that may cause mechanical damage when the balance is moved.
Before removing the AC adapter, press the **ON:OFF** key and confirm that zero is displayed.
- When the AC adapter is connected, the balance is in the standby mode if the standby indicator is on (refer to “3-5 Display Symbols and Key Operation”). This is a normal state and does not harm the balance. For accurate weighing, keep the AC adapter connected to the balance and AC power unless the balance is not to be used for a long period of time.

3-5 Display Symbols and Key Operation

Key operation

Key operation affects how the balance functions. The basic key operations are:

- “Press and release the key immediately” or “Press the key”
= normal key operation during measurement
- “Press and hold the key”

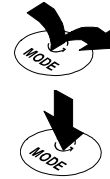

Display symbols

- Displays memory data information
- Displays the weighing data relative to the weighing capacity, in percentage, in the weighing mode (**Capacity indicator**)

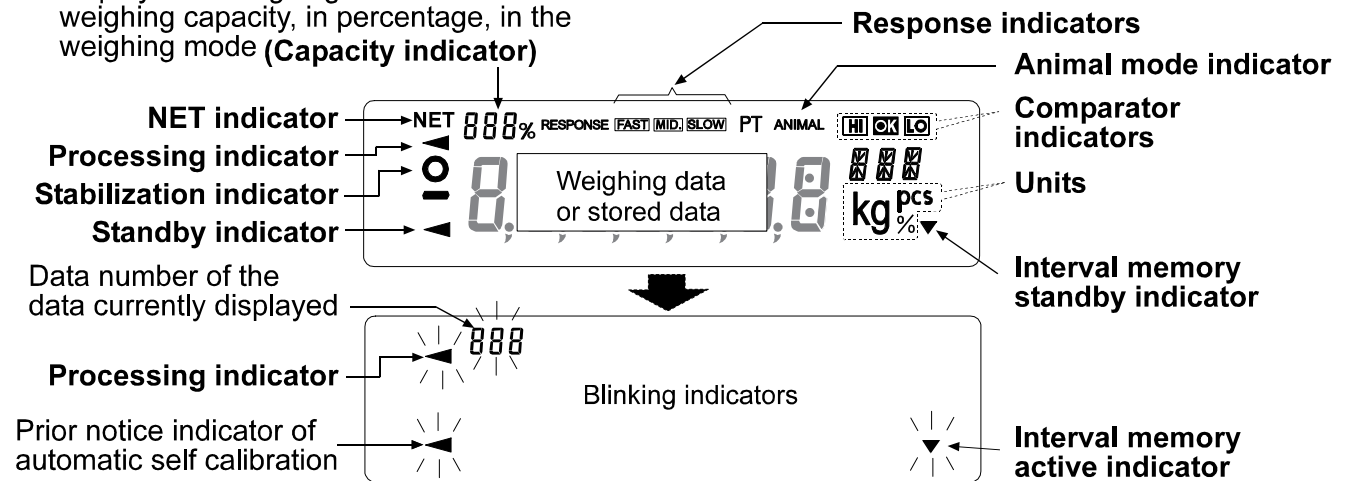

Each key, when pressed or when pressed and held, functions as follows:

Key	When pressed	When pressed and held
	Turns the display ON and OFF. The standby indicator is displayed when the display is turned off. The weighing mode is enabled when the display is turned on. This key is available anytime. Pressing the key during operation will interrupt the operation and turn the display OFF.	
	In the weighing mode, turns the minimum weighing value ON and OFF. (Does not function on the balance models with a minimum display of 1 g.) In the counting or percent mode, enters the sample storing mode.	Enters the function table mode. Refer to “9. FUNCTION TABLE”.
	Switches the weighing units stored in the function table. Refer to “4. WEIGHING UNITS”.	Performs response adjustment and self check.
	Performs calibration of the balance using the internal mass.	Displays other items of the calibration menu.
	Stores the weighing data in memory or outputs to a printer or personal computer depending on the function table settings. (Factory setting = output)	No function at the factory setting By changing the function table: Outputs “Title block” and “End block” for GLP report. Displays the data memory menu.
	Sets the display to zero.	

3-6 Smart Range Function

The GP-32K, GP-32KS and GP-102K are equipped with two ranges. The precision range has a higher resolution. The standard range has normal resolution.

The range is switched automatically, depending on the value displayed. Pressing the **RE-ZERO** key allows weighing in the precision range, regardless of the tare value. (Smart range function)

The range can be fixed to the standard range, by pressing the **SAMPLE** key.

Note

Once the range is switched to the standard range, it will not switch to the precision range automatically even when the displayed value becomes within the precision range value. Use the **RE-ZERO or **SAMPLE** key to activate the precision range again.**

Below is a description of how the Smart Range actually functions, using the GP-102K

(Precision range=61 kg×1 g, Standard range=101 kg×10 g)

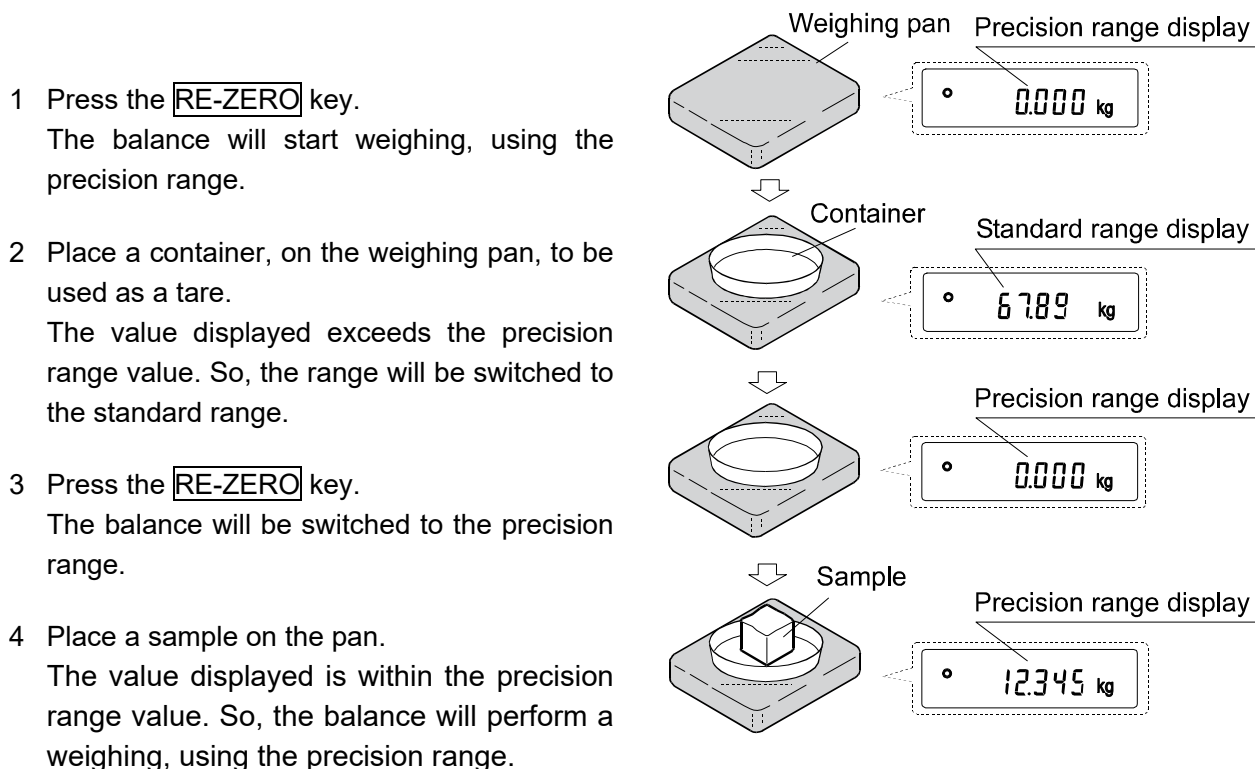

Precision range/standard range value

	GP-32K/GP-32KS	GP-102K
Precision range (after RE-ZERO is pressed)	Up to 6.1009 kg	Up to 61.009 kg
Standard range	6.101 to 31.008 kg	61.01 to 101.08 kg

4. WEIGHING UNITS

4-1 Units

With the GP series balance, the following weighing units and weighing modes are available :

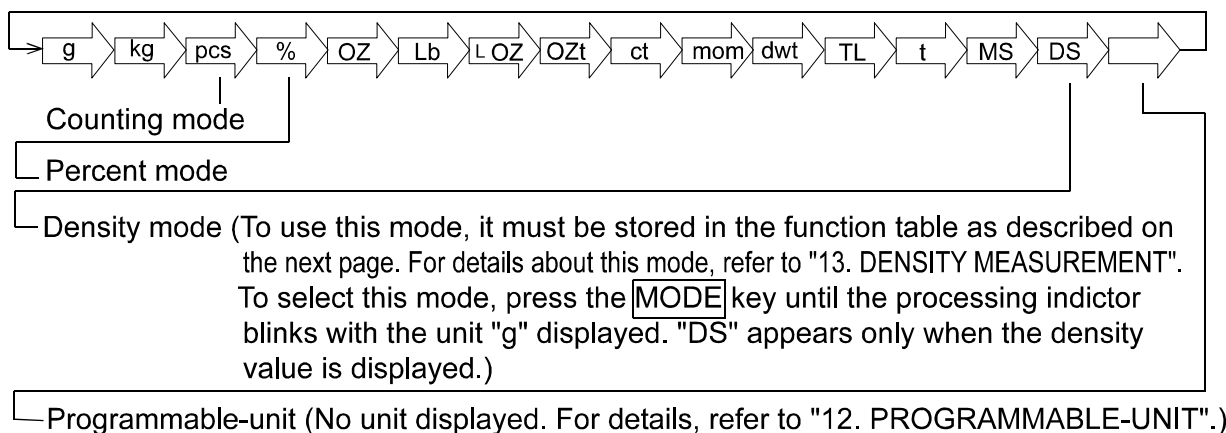

A unit or mode can be selected and stored in the function table as described in "4-2 Changing the Units". If a weighing mode (or unit of weight) has been turned off, that mode or unit will be missing in the sequence. Tael has four varieties, one of which can be selected and installed at the factory.

For details about the units and modes, see the table below:

Name (unit, mode)	Abbrev.	Display	Function table (Storing mode)	Conversion factor 1 g =
Gram	g	g	g	1 g
kilogram	kg	kg	kg	1000 g
Counting mode	PCS	pcs	pcs	—
Percent mode		%	%	—
Ounce (Avoir)	OZ	OZ	OZ	28.349523125 g
Pound	Lb	Lb	Lb	453.59237 g
Pound/Ounce	L OZ	L OZ	L O	1Lb=16 oz, 1 oz=28.349523125 g
Troy Ounce	OZt	OZt	OZt	31.1034768 g
Metric Carat	ct	ct	ct	0.2 g
Momme	mom	mom	mom	3.75 g
Pennyweight	dwt	dwt	dwt	1.55517384 g
Tael (HK general, Singapore)	TL	TL	TL	37.7994 g
Tael (HK jewelry)				37.429 g
Tael (Taiwan)				37.5 g
Tael (China)				31.25 g
Tola (India)	t	t	t	11.6638038 g
Messghal	MS	MS	MS	4.6875 g
Density mode	DS	g ← ^{d-R} DS is used to show the density.	DS	—
Programmable-unit (Multi-unit)	Mlt	—	MLt	—

Note: The units, g, ct and dwt are not available for the GP-102K.

The tables below indicate the weighing capacity and the minimum display for each unit, depending on the balance model.

Unit	GP-12K	GP-20K	GP-30K GP-30KS	GP-61K GP-61KS	Minimum display	GP-40K	Minimum display
	Capacity					Capacity	
Gram	12000.0	21000.0	31000.0	61000.0	0.1	41000.0	0.5
Kilogram	12.0000	21.0000	31.0000	61.0000	0.0001	41.0000	0.0005
Ounce (Avoir)	423.290	740.755	1093.495	2151.710	0.005	1446.24	0.02
Pound	26.4555	46.2970	68.3435	134.4820	0.0005	90.390	0.002
Pound/Ounce	26L 7.29	46L 4.75	68L 5.49	134L 7.7	0.01	90L 6.24	0.02
Troy Ounce	385.810	675.165	996.675	1961.195	0.005	1318.18	0.02
Metric Carat	60000.0	105000.0	155000.0	305000.0	0.5	205000	5
Momme	3200.00	5600.00	8266.65	16266.65	0.05	10933.4	0.2
Pennyweight	7716.2	13503.3	19933.5	39223.9	0.1	26363.5	0.5
Tael (HK general, Singapore)	317.465	555.565	820.120	1613.780	0.005	1084.68	0.02
Tael (HK jewelry)	320.605	561.060	828.235	1629.750	0.005	1095.40	0.02
Tael (Taiwan)	320.000	560.000	826.665	1626.665	0.005	1093.34	0.02
Tael (China)	384.000	672.000	992.000	1952.000	0.005	1312.00	0.02
Tola (India)	1028.82	1800.44	2657.80	5229.85	0.01	3515.15	0.05
Messghal	2560.00	4480.00	6613.35	13013.35	0.05	8746.6	0.2

Unit	GP-60K GP-60KS	GP-100K GP-100KS	Minimum display
	Capacity		
Gram	61000	101000	1
Kilogram	61.000	101.000	0.001
Ounce (Avoir)	2151.70	3562.65	0.05
Pound	134.480	222.665	0.005
Pound/Ounce	134L 7.7	222L 10.7	0.1
Troy Ounce	1961.20	3247.25	0.05
Metric Carat	305000	505000	5
Momme	16266.5	26933.5	0.5
Pennyweight	39224	64945	1
Tael (HK general, Singapore)	1613.80	2672.00	0.05
Tael (HK jewelry)	1629.75	2698.45	0.05
Tael (Taiwan)	1626.65	2693.35	0.05
Tael (China)	1952.00	3232.00	0.05
Tola (India)	5229.9	8659.3	0.1
Messghal	13013.5	21546.5	0.5

Unit	GP-32K/ GP-32KS			
	Standard range		Precision range	
	Capacity	Minimum display	Capacity	Minimum display
Gram	31000	1	6100.0	0.1
Kilogram	31.000	0.001	6.1000	0.0001
Ounce (Avoir)	1093.50	0.05	215.170	0.005
Pound	68.345	0.005	13.4480	0.0005
Pound/Ounce	68L 5.5	0.1	13L 7.17	0.01
Troy Ounce	996.65	0.05	196.120	0.005
Metric Carat	155000	5	30500.0	0.5
Mom me	8266.5	0.5	1626.65	0.05
Pennyweight	19933	1	3922.4	0.1
Tael (HK general, Singapore)	820.10	0.05	161.380	0.005
Tael (HK jewelry)	828.25	0.05	162.975	0.005
Tael (Taiwan)	826.65	0.05	162.665	0.005
Tael (China)	992.00	0.05	195.200	0.005
Tola (India)	2657.8	0.1	522.99	0.01
Messghal	6613.5	0.5	1301.35	0.05

Unit	GP-102K			
	Standard range		Precision range	
	Capacity	Minimum display	Capacity	Minimum display
Gram	—	—	—	—
Kilogram	101.00	0.01	61.000	0.001
Ounce (Avoir)	3562.5	0.5	2151.70	0.05
Pound	222.65	0.05	134.480	0.005
Pound/Ounce	222L 11	1	134L 7.7	0.1
Troy Ounce	3247.0	0.5	1961.20	0.05
Metric Carat	—	—	—	—
Momme	26935	5	16266.5	0.5
Pennyweight	—	—	—	—
Tael (HK general, Singapore)	2672.0	0.5	1613.80	0.05
Tael (HK jewelry)	2698.5	0.5	1629.75	0.05
Tael (Taiwan)	2693.5	0.5	1626.65	0.05
Tael (China)	3232.0	0.5	1952.00	0.05
Tola (India)	8659	1	5229.9	0.1
Messghal	21545	5	13013.5	0.5

4-2 Changing the Units

The units or modes can be selected and stored in the function table. The sequence of displaying the units or modes can be arranged so as to fit the frequency of use in the function table.

Select a unit or mode and arrange the sequence of display as follows:

- 1 Press and hold the **SAMPLE** key until **bRSFnC** of the function table is displayed, then release the key.
- 2 Press the **SAMPLE** key several times to display **Unit**.
- 3 Press the **PRINT** key to enter the unit selection mode.
- 4 Specify a unit or mode in the order to be displayed using the following keys.

SAMPLE key To sequentially display the units.

RE-ZERO key To specify a unit or mode. The stabilization indicator appears when the displayed unit or mode is specified.

- 5 Press the **PRINT** key to store the units or modes. The balance displays **End** and then displays the next menu item of the function table.

- 6 Press the **CAL** key to exit the function table. Then the balance returns to the weighing mode with the selected unit.

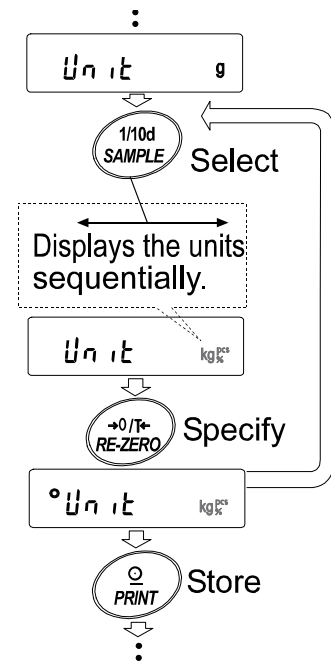

5. WEIGHING

5-1 Basic Operation (Kilogram Mode)

- 1 Place a container on the weighing pan, if necessary.
Press the **RE-ZERO** key to cancel the weight (tare). The balance displays **0.0000 kg**. (The decimal point position depends on the balance model.)
- 2 Place a sample on the pan or in the container.
- 3 Wait for the stabilization indicator to be displayed. Read the value.
- 4 Remove the sample and container from the pan.

Notes

To use another unit, press the **MODE** key and select an appropriate unit.

Press the **SAMPLE** key to turn on or off the minimum weighing value.

The weighing data can be stored in memory. For details, refer to "11. DATA MEMORY".

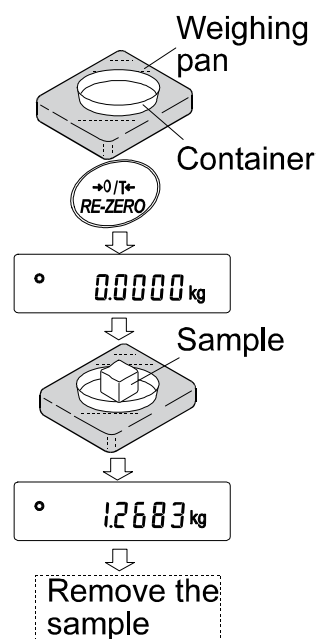

5-2 Counting Mode (PCS)

This is the mode to determine the number of objects in a sample based on the standard sample unit mass. Unit mass means the mass of one sample. The smaller the variables in each sample unit mass is, the more accurate the counting will be. The GP series balance is equipped with the Automatic Counting Accuracy Improvement (ACAI) function to improve the counting accuracy.

Note

If the sample unit mass variable, the difference from sample to sample, is too large, it may cause a counting error.

Selecting the counting mode

- 1 Press the **MODE** key to select **pcs** (counting mode).

Storing a sample unit mass (Weighing input mode)

- 2 Press the **SAMPLE** key to enter the sample unit mass storing mode.
- 3 To select the number of samples, press the **SAMPLE** key several times. It may be set to 10, 25, 50 or 100.

Note

A greater number of samples will yield more accurate counting result.

- 4 Place a container on the weighing pan, if necessary. Press the **RE-ZERO** key to cancel the weight (tare). The number specified in step 3 appears.

e.g.: **25 0 pcs** is displayed if 25 is selected in step 3.

- 5 Place the number of samples specified on the pan. In this example, 25 pieces.
- 6 Wait for the stabilization indicator to come on. Press the **PRINT** key to calculate and store the unit mass. The balance displays **25 pcs** (counting mode) and is set to count samples with this unit mass. (The sample unit mass stored, even if the AC adapter is removed, is maintained in non-volatile memory.)

To improve the accuracy of the unit mass, proceed to step 8.

Notes

If the balance judges that the mass of the samples is too light and can not be stored as the unit mass, it displays **Lo**.

If the balance judges that the mass of the samples is too light to acquire accurate weighing, it displays an error requiring the addition of more samples to the specified number. In the example above, **50 pcs** appears, requiring 25 more samples. Add 25 samples and press the **PRINT** key. When the unit mass is stored correctly, the balance proceeds to the counting mode.

Key entry of the unit mass value (digital input mode) is possible. For details, refer to “11-4 Memory for Unit Mass in the Counting Mode”

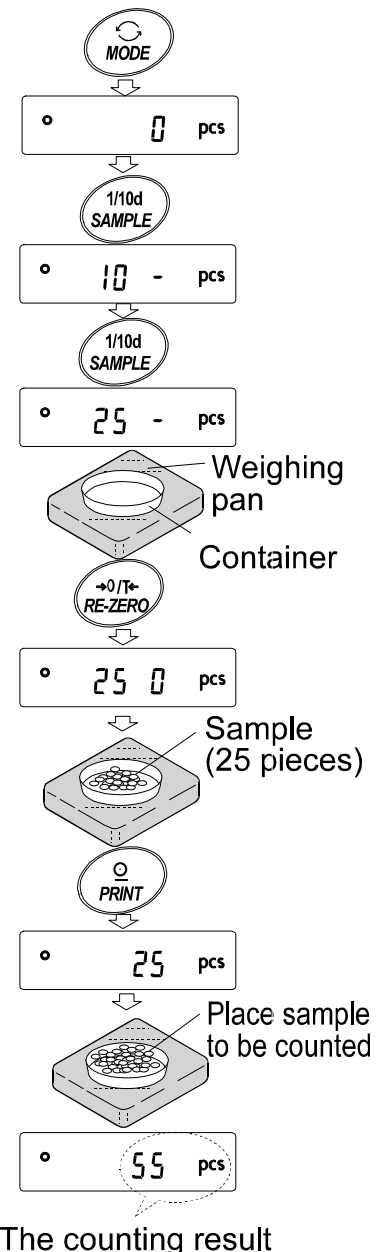

Counting operation

- 7 Place the samples to be counted on the pan.

Note

Up to 50 unit masses can be stored in memory for the multiple sample. For details, refer to “11. DATA MEMORY”.

Counting mode using the ACAI function

The ACAI is a function that improves the accuracy of the unit mass automatically by increasing the number of samples as the counting process proceeds.

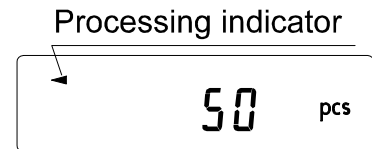

- 8 If a few more samples are added, the processing indicator turns on. To prevent an error, add three or more. The processing indicator does not turn on if overloaded. Try to add the same number of samples as displayed.
- 9 The balance re-calculates the unit mass while the processing indicator is blinking. Do not touch the balance or samples on the pan until the processing indicator turns off.
- 10 Counting accuracy is improved when the processing indicator turns off.

Each time the above operation is performed, a more accurate unit mass will be obtained. There is no definite upper limit of ACAI range for the number of samples exceeding 100. Try to add the same number of samples as displayed.

- 11 Remove all the samples used in ACAI and proceed with the counting operation using the improved unit mass.

Note

ACAI will not function on the unit mass entered using the keys, or digital input mode.

5-3 Percent Mode (%)

This is the mode to display the weight value in percentage compared to a 100% reference mass and is used for target weighing or checking the sample variable.

Selecting the percent mode

- 1 Press the **MODE** key to select **%** (percent mode). If the percent mode can not be selected, refer to “4. WEIGHING UNITS”.

Storing the 100% reference mass

- 2 Press the **SAMPLE** key to enter the 100% reference mass storing mode. Even in the storing mode, pressing the **MODE** key will switch to the next mode.
- 3 Place a container on the weighing pan, if necessary. Press the **RE-ZERO** key to cancel the weight (tare). The balance displays **100 0 %**.
- 4 Place the sample to be set as the 100% reference mass on the pan or in the container.
- 5 Press the **PRINT** key to store the reference mass. The balance displays **100.00 %**. (The decimal point position depends on the reference value. The reference mass stored, even if the AC adapter is removed, is maintained in non-volatile memory.)

Note

If the balance judges that the mass of the sample is too light to be used as a reference, it displays **Lo**.

- 6 Remove the sample.

Reading the percentage

- 7 Place a sample to be compared to the reference mass on the pan. The displayed percentage is based on the 100% reference mass.

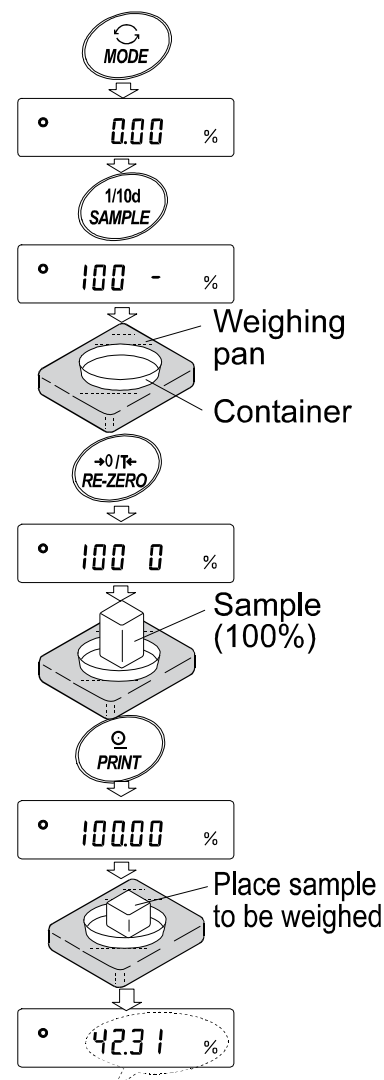

Weighing result compared to 100% reference mass

5-4 Animal Weighing Mode (Hold Function)

This is the mode to weigh a moving object such as an animal, even when the display of the weighing data fluctuates. The hold function allows the average weight of the animal to be displayed.

To use the hold function, set the function in the function table. For details, refer to “9. FUNCTION TABLE” and “9-4 Description of the Class “Environment, Display””.

5-5 Accumulation Function

The accumulation function adds the weighing data and displays the total value.

To use the accumulation function, set the “Accumulation function (*Add*)” parameter of the function table as described below.

Note

While the accumulation function is in use, the data memory function is not available. When using the accumulation function, make sure that the “Data memory (*dAtA*)” parameter of the function table is set to “0”.

Selecting the unit

- 1 Press the **MODE** key to select a unit to be used for accumulation.

Note

While the accumulation function is in use, unit selection using the **MODE key is not available.**

Setting the function table

- 2 Press and hold the **SAMPLE** key until **bASFnC** of the function table is displayed, then release the key.
- 3 Press the **PRINT** key.
- 4 Press the **SAMPLE** key several times to display **Add 0**.
- 5 Press the **RE-ZERO** key to display **Add 1**.

Note

To disable the accumulation function, set the “Accumulation function (*Add*)” parameter to “0”.

- 6 Press the **PRINT** key to store the setting.
- 7 Press the **CAL** key to return to the weighing mode.

Using the accumulation function

Use the keys below to operate the accumulation function.

MODE key: Displays the weighing data and the total value alternately each time it is pressed. Will not change the unit while the accumulation function is in use.

RE-ZERO key: Sets the display to zero while the weighing data is displayed. Deletes the total value while the total value is displayed.

PRINT key: Outputs and adds the weighing data while the weighing data is displayed. Outputs the total value while the total value is displayed.

- 1 Press the **RE-ZERO** key to set the display to zero.
- 2 Place a sample on the pan. The weight value is displayed.
- 3 Press the **PRINT** key. The weight value is added to the total and output. The accumulation number at the upper left of the display increases by one.
- 4 Repeat steps 1-3 to accumulate more data.
- 5 Press the **MODE** key to display the total value.

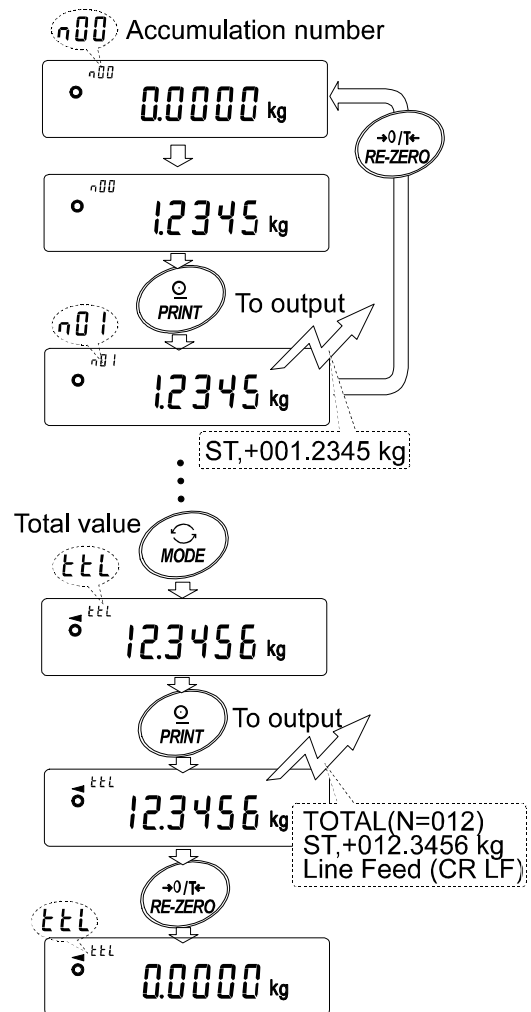

Outputting the value

- 6 Press the **PRINT** key to output the total value.
- 7 Press the **RE-ZERO** key to delete the total value.

Notes

The output format depends on the function table setting.

While the accumulation function is in use, the data memory function is not available.

To disable the accumulation function, set the "Accumulation function (Add)" parameter to "0".

When the "Data number output (d-no)" parameter is set to "1", the accumulation number will be output before the weighing data.

When the accumulation number exceeds 99:

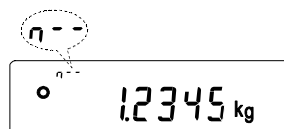

When the total value exceeds the maximum displayable value (999.9999):

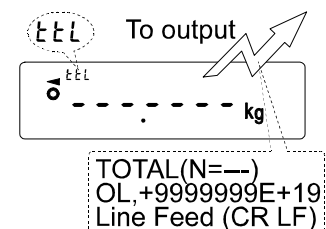

6. RESPONSE ADJUSTMENT / SELF CHECK FUNCTION

This function detects the influence on weighing that is caused by drafts and/or vibration at the place where the balance is installed and sets the response characteristic automatically. When this function is selected, the balance self-checks the performance at the same time.

Two modes of response adjustment are available: automatic and manual.

The function has three rates as follows:

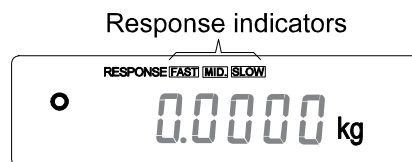

Changing the response rate changes the display refresh rate.

Indicator	Parameter	Response characteristic	Display refresh rate
FAST	[and 0]	Fast response, Sensitive value ↑ ↓	If the response rate is changed as follows: MID. or SLOW → FAST = 10 times/second FAST → MID. or SLOW = 5 times/second
MID.	[and 1]		
SLOW	[and 2]		

Note

To set the refresh rate of 5 times/second when the response rate is **FAST** or 10 times/second when the response rate is **MID.** or **SLOW**, change the “Display refresh rate (SPd)” parameter of “Environment, Display (bR5Fnc)” in the function table. For details, refer to “9. FUNCTION TABLE”.

6-1 Automatic Response Adjustment / Self Check Function

This function automatically updates the response adjustment by analyzing the influence of the environment on the weighing data and also self-checks the balance performance using the internal mass.

Operation

- 1 Press and hold the **MODE** key until **RESPONSE** is displayed, then release the key.
- 2 The balance automatically starts to check the balance performance and sets the response characteristic.

Caution

Do not allow vibration or drafts to affect the balance during adjustment.

- 3 After automatic adjustment, the balance displays the updated response indicator and returns to the weighing mode. The response indicator remains displayed for a while.

e.g. “**MID.** **OK**”

The example above indicates that the result of the self check is good and **MID.** is selected as the response rate.

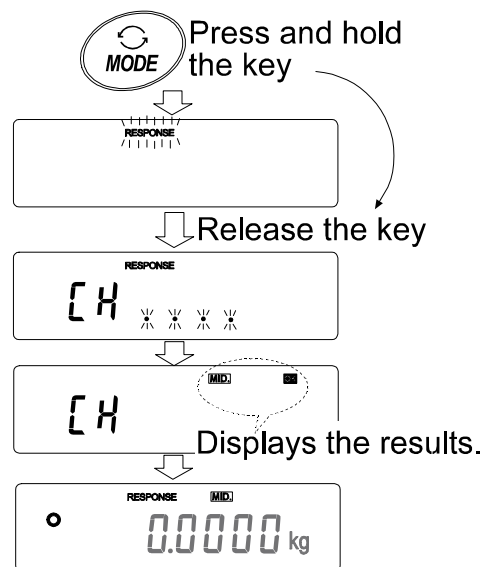

Notes

If improper performance is found in the self check, the balance displays [CH n0]. Contact the local A&D dealer for repair.

If the automatic response adjustment fails, the balance displays [CH n0]. Check the ambient conditions such as breeze and vibration, also check the weighing pan. Then, perform the adjustment again. To return to the weighing mode, press the [CAL] key.

If the automatic response adjustment is awkward, try to refine it using the manual response adjustment.

6-2 Manual Response Adjustment

This function manually updates the response adjustment.

Operation

- 1 Press and hold the [MODE] key until [RESPONSE] is displayed, then release the key.

And then, press the [MODE] key again quickly.

- 2 Press the [MODE] key to select a rate of the response adjustment. Either [FAST], [MID.] or [SLOW] can be selected.

- 3 After a few seconds of inactivity the balance displays [End]. Then, it returns to the weighing mode and displays the updated response indicator. The response indicator remains displayed for a while.

Note

The response adjustment can be changed at “Condition (End)” of “Environment, Display (bASFnC)” in the function table. For details, refer to “9. FUNCTION TABLE”.

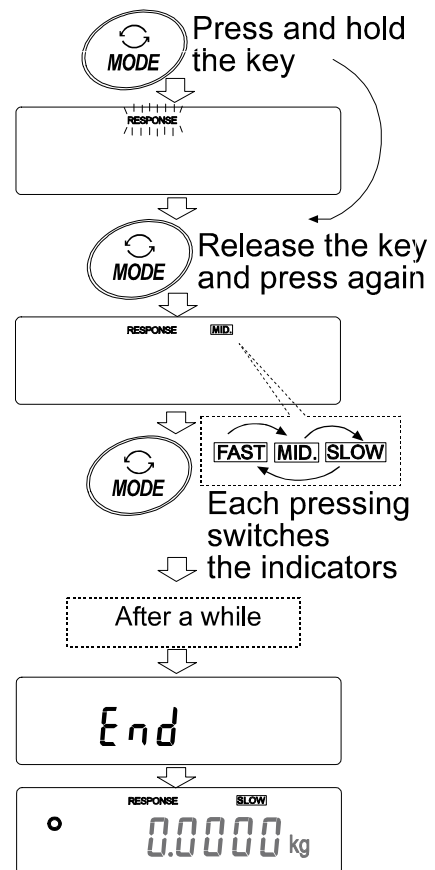

7. CALIBRATION

7-1 Calibration Group

The GP series balance has the following modes as a calibration group.

- | | |
|---------------------------------------|---|
| Calibration | <ul style="list-style-type: none"> ● Automatic self calibration (calibration due to changes in temperature) ● Calibration using the internal mass (one-touch calibration) ● Calibration using an external weight |
| Calibration test | <ul style="list-style-type: none"> ● Calibration test using an external weight (Calibration test does not perform calibration.) |
| Correction of the internal mass value | |

Terms

The following terms are defined as follows:

- | | | |
|--------------------|---|--|
| Internal mass | = | Built-in calibration weight |
| External weight | = | A weight that you have. Referred to as a calibration weight when used for calibration. |
| Calibration weight | = | A weight used for calibration |
| Target weight | = | An external weight used for calibration test |

Caution

- Calibration adjusts the balance for accurate weighing.
Besides periodic calibration and before each use, perform calibration when:
 - the balance is installed for the first time.
 - the balance has been moved.
 - the ambient environment has changed.
- Do not allow vibration or drafts to affect the balance during calibration.
- To output the data for GLP using the RS-232C interface, set "GLP output (*inF0*)" of "Data output (*dout*)". For details, refer to "9. FUNCTION TABLE". Time and date are added to the GLP report. If the time or date is not correct, adjust them. For details, refer to "9-9 Clock and Calendar Function".
- Calibration test is available only when "GLP output (*inF0*)" of "Data output (*dout*)" is set to "1" or "2".
- The calibration and calibration test data can be stored in memory. To store them, set "Data memory (*dRRR*)" to "3". For details, refer to "11. DATA MEMORY".

Caution on using an external weight

- The accuracy of an external weight will influence the accuracy of weighing. Select an appropriate weight as listed below:

Model	Usable calibration weight	Adjustable range
GP-12K	5 kg, 10 kg	-1.5 g to +1.5 g
GP-20K	10 kg, 20 kg	
GP-30K/GP-30KS	20 kg , 30 kg	
GP-32K/ GP-32KS	20 kg , 30 kg	
GP-40K	20 kg, 30 kg, 40 kg	
GP-60K/ GP-60KS	30 kg, 40 kg, 50 kg, 60 kg	-15 g to +15 g
GP-61K/ GP-61KS	30 kg, 40 kg, 50 kg, 60 kg	-1.5 g to +1.5 g
GP-100K/GP-100KS	60 kg, 80 kg, 100 kg	-15 g to +15 g
GP-102K	60 kg, 80 kg, 100 kg	

The calibration weight in bold type: factory setting

The calibration weight value can be adjusted within the range above.

Display



- This indicator means “the balance is measuring calibration data”. Do not allow vibration or drafts to affect the balance while this indicator is displayed.

7-2 Automatic Self Calibration (Calibration due to changes in temperature)

This function automatically calibrates the balance when the balance detects an ambient temperature change. If GLP output is selected in the function table, the balance outputs the calibration report or stores the data in memory. Automatic self calibration functions even if the display is turned off (standby state).

Caution

If something is on the weighing pan, the balance judges that it is in use and does not perform automatic self calibration. To maintain the calibrated state, keep the weighing pan clear while not in use.

The displays shown below are related to the automatic self calibration.



Indicates that the balance detects a change in ambient temperature and automatic self calibration will start. If the balance is not used for a few minutes with this indicator blinking, the balance performs automatic self calibration. The blinking duration depends on the environment.

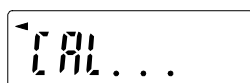

Indicates that the balance is measuring calibration data. Do not allow vibration or drafts to affect the balance while this indicator is displayed. After calibration, the balance returns to indicate the previous display.

Note

The balance can be used while the indicator blinks. But, it is recommended that to maintain the accuracy, stop using the balance and confirm that there is nothing on the pan and allow the balance to perform self calibration.

7-3 Calibration Using the Internal mass (One-Touch Calibration)

This function calibrates the balance using the internal mass. The only operation required is to press the **CAL** key.

Operation

- 1 Plug in the AC adapter and warm up the balance for at least 30 minutes with nothing on the weighing pan.
- 2 Press the **CAL** key.
- 3 The balance displays **CAL in** and performs calibration using the internal mass. Do not allow vibration or drafts to affect the balance
- 4 The balance displays **End** after calibration. If the “GLP output (info)” parameter of the function table is set to “1” or “2”, the balance displays **GLP** and outputs “Calibration Report” using the RS-232C interface or stores the data in memory. For details on the calibration report format, refer to “10-2 GLP Report”.
- 5 The balance will automatically return to the weighing mode after calibration.

About the internal mass

The mass of the internal mass may change due to corrosion or other damage caused by the operating environment, or due to aging. Check the internal mass periodically. Correct the internal mass value as necessary. For details, refer to “7-6 Correcting the internal mass value”.

To maintain the weighing accuracy, perform the calibration using an external weight periodically, as described below.

7-4 Calibration Using an External Weight

This function calibrates the balance using an external weight.

Operation

- 1 Plug in the AC adapter and warm up the balance for at least 30 minutes with nothing on the pan.
- 2 Press and hold the **CAL** key until **CALout** is displayed, then release the key.
- 3 The balance displays **CAL 0**.
 - If you want to change the calibration weight (a list of usable weights is shown on page 25), press the **SAMPLE** key and proceed to step 4.
 - If you use the calibration weight value stored in the balance, proceed to step 5.
- 4 Specify the calibration weight value as follows:

SAMPLE key To switch the display condition to: "All of the segments blinking" (calibration weight selection mode) or "The last two digits blinking" (value adjustment mode).

RE-ZERO key To select the calibration weight or adjust the value. In the value adjustment mode, -15 digits appear after +15 digits.

PRINT key To store the new weight value. Even if the AC adapter is removed, the data is maintained in non-volatile memory.

CAL key To cancel the operation and return to **CAL 0**.

Note

Digit, when used for the GP series balance, indicates the smallest displayable weighing value.

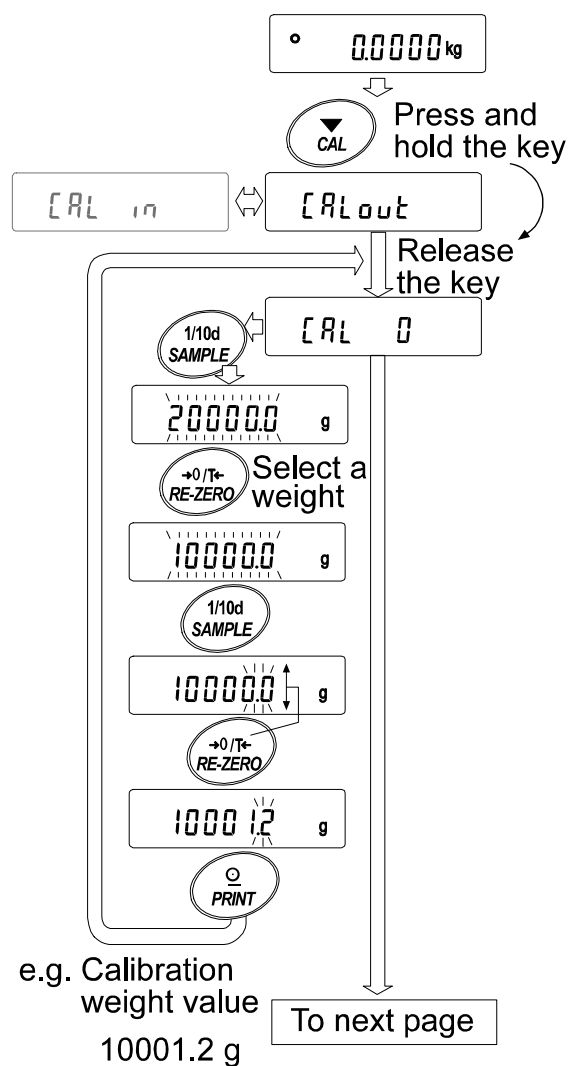

- 5 Confirm that there is nothing on the pan and press the **PRINT** key. The balance measures the zero point. Do not allow vibration or drafts to affect the balance.
The balance displays the calibration weight value.
- 6 Place the displayed calibration weight on the pan and press the **PRINT** key. The balance measures the calibration weight. Do not allow vibration or drafts to affect the balance.
- 7 The balance displays **End**. Remove the weight from the pan.
- 8 If the “GLP output (info)” parameter, of the function table, is set to “1” or “2”, the balance displays **GLP** and outputs “Calibration Report” using the RS-232C interface or stores the data in memory. For details on the calibration report format, refer to “10-2 GLP Report”.
- 9 The balance will automatically return to the weighing mode.
- 10 Place the calibration weight on the pan and confirm that the value displayed is within ± 2 digits of the specified value. If it is not within the range, check the ambient conditions such as breeze and vibration, also check the weighing pan. Then, repeat steps 1 to 10.

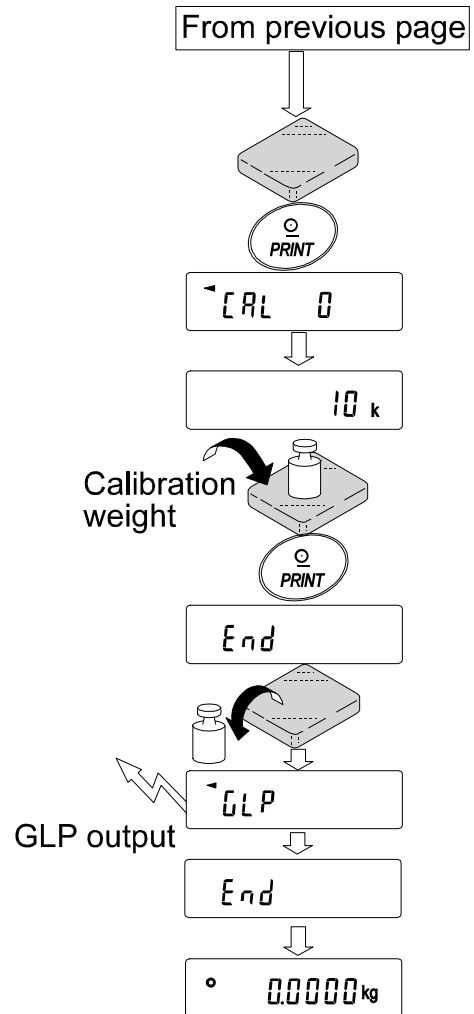

7-5 Calibration Test Using an External Weight

This function tests the balance weighing accuracy using an external mass and outputs the result. This is available only when the “GLP output (INF0)” parameter is set to “1” or “2”. (Calibration test does not perform calibration.)

Operation

- 1 Connect the AC adapter and warm up the balance for at least 30 minutes with nothing on the pan.
- 2 Press and hold the **CAL** key until **[[out** is displayed, then release the key.
- 3 The balance displays **[[0**.
 - If you want to change the target weight (a list of usable weights is shown on page 25), press the **SAMPLE** key and proceed to step 4.
 - If you use the target weight value stored in the balance, proceed to step 5.
- 4 Specify the target weight value as follows:

SAMPLE key To switch the display condition to: “All of the segments blinking” (target weight selection mode) or “The last two digits blinking” (value adjustment mode).

RE-ZERO key To select the target weight or adjust the value. In the value adjustment mode, -15 digits appear after +15 digits.

PRINT key To store the new weight value. Even if the AC adapter is removed, the data is maintained in non-volatile memory.

CAL key To cancel the operation and return to **[[0**.

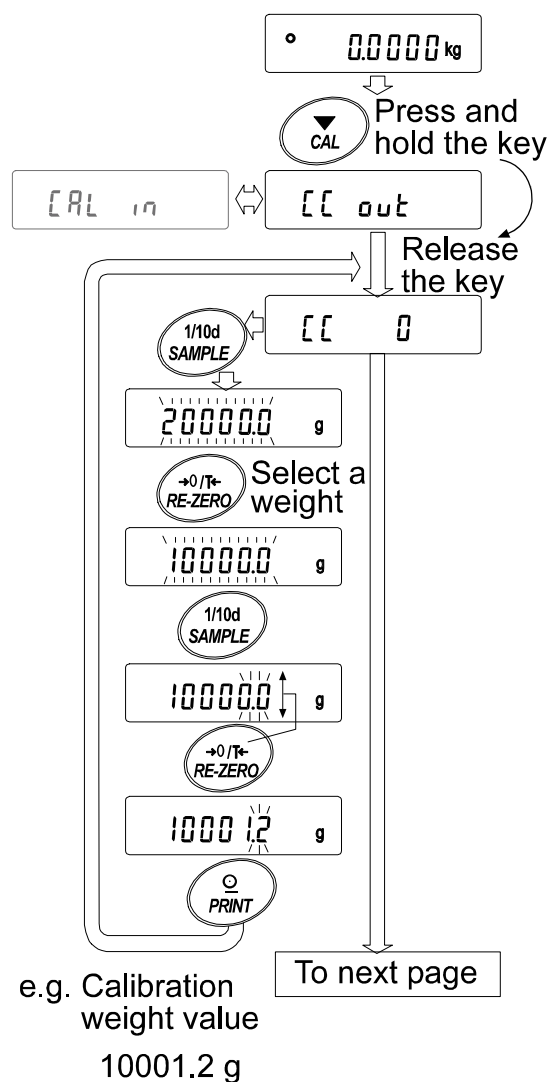

Note

Digit, when used for the GP series balance, indicates the smallest displayable weighing value

- 5 Confirm that there is nothing on the pan and press the **PRINT** key. The balance measures the zero point and displays the measured value. Do not allow vibration or drafts to affect the balance.
The balance displays the target weight value.
- 6 Place the displayed target weight on the pan and press the **PRINT** key. The balance measures the target weight and displays the measured value. Do not allow vibration or drafts to affect the balance.
- 7 The balance displays **End**. Remove the weight from the pan.
- 8 The balance displays **GLP** and outputs “Calibration Test Report” using the RS-232C interface or stores the calibration test data in memory. For details on the calibration test report format, refer to “10-2 GLP Report”.
- 9 The balance will automatically return to the weighing mode.

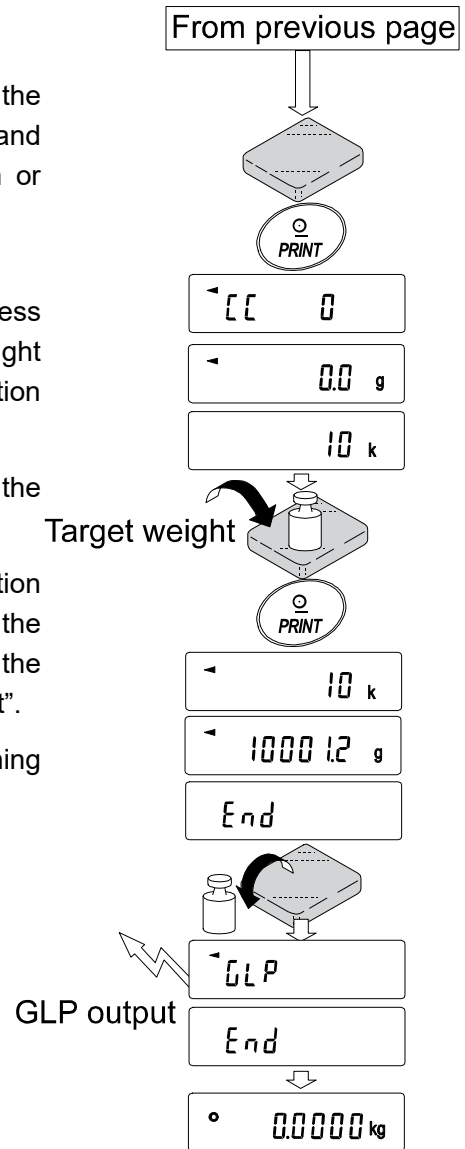

7-6 Correcting the Internal Mass Value

The GP series balance can correct the internal mass value within the range shown below. This function corrects the internal mass value to conform to an external weight. The corrected mass value is maintained in non-volatile memory even if the AC adapter is removed.

The internal mass value is corrected as follows:

Model	Correction reference value	Correction range
GP-12K	10 kg	-5.0 g to +5.0 g
GP-20K	20 kg	
GP-30K/GP-30KS		
GP-32K/ GP-32KS		
GP-61K/ GP-61KS		
GP-40K	40 kg	-50 g to +50 g
GP-60K/ GP-60KS	60 kg	
GP-100K/GP-100KS	100 kg	
GP-102K		-50 g to +50 g

Example: Using the GP-20K

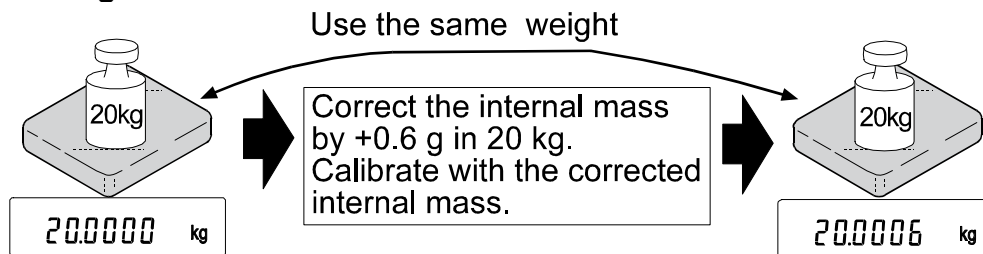

Operation

- 1 Calibrate the balance using the internal mass. (one-touch calibration) Then, place an external weight and confirm the value to be corrected.

In the example, the value is to be corrected by 0.6 gram in 20 kilograms.

- 2 Press the **ON:OFF** key to turn off the display.
- 3 While pressing and holding the **PRINT** key and the **SAMPLE** key, press the **ON:OFF** key. The balance displays **P5**.
- 4 Press the **PRINT** key. Then the balance displays the function switches.

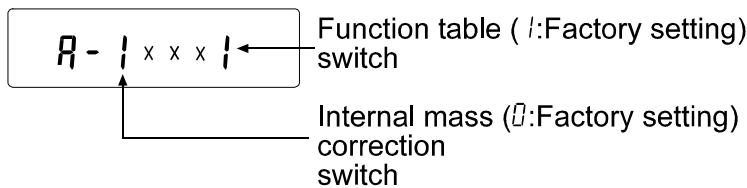

Set the function table switch and internal mass correction switch to “1” as shown above using the following keys.

- SAMPLE** key To select the switch to change the value. The selected digit blinks.
- RE-ZERO** key To change the parameter of the switch selected.

- 5 Press the **PRINT** key to store the new setting. The balance returns to the weighing mode.
- 6 Press and hold the **SAMPLE** key to enter the function table and release the key when **bRSFnC** is displayed.
- 7 Press the **SAMPLE** key several times until **[5 in** is displayed, then release the key.
- 8 Press the **PRINT** key to enter the procedure for correcting the internal mass value.
- 9 Correct the internal mass value using the following keys.

- RE-ZERO** key To select the value. (-50 digits appear after +50 digits.)
- PRINT** key To store the new value and display the next menu item of the function table.
- CAL** key To cancel the correction and display the next menu item of the function table.

- 10 Press the **CAL** key. The balance returns to the weighing mode.
- 11 Press the **CAL** key to calibrate the balance using the internal mass.
- 12 Place the external weight on the pan and confirm that the correction has been performed properly. In this example, confirm that the value displayed is within ± 2 digits of the correction reference value or 20 kilograms. If the value is not within ± 2 digits of the correction value, repeat the above procedure to correct it.

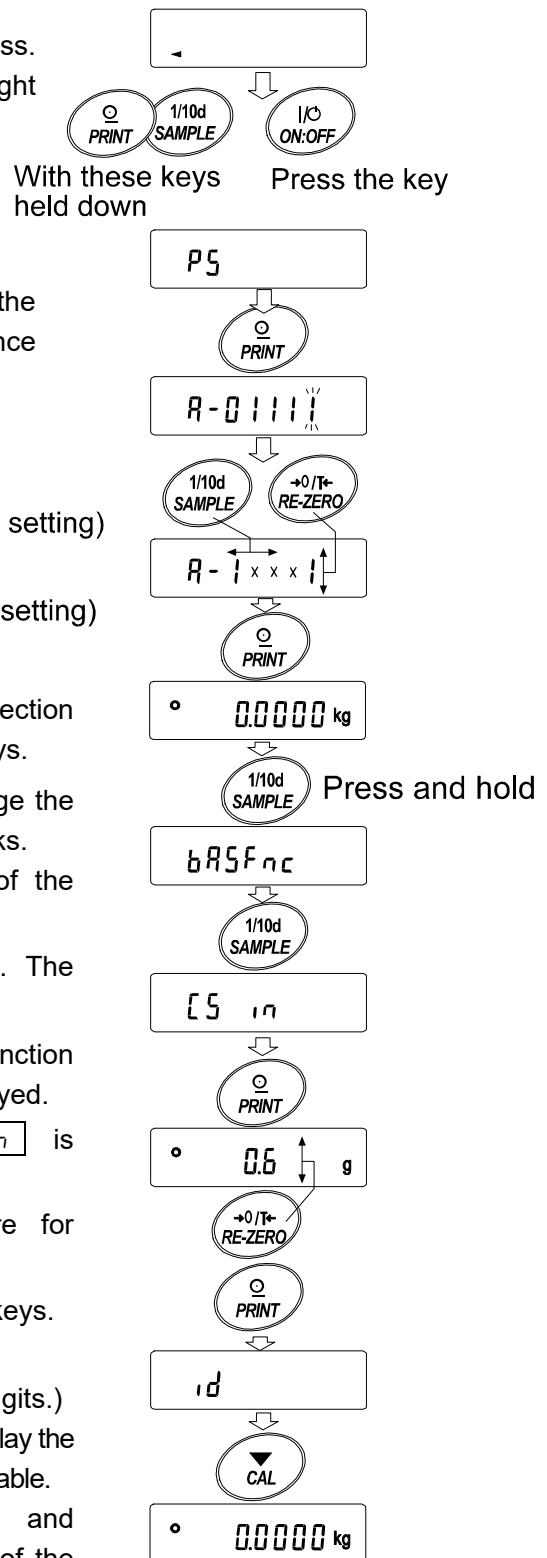

8. FUNCTION SWITCH AND INITIALIZATION

8-1 Permit or Inhibit

The balance stores parameters that must not be changed unintentionally (e.g. Calibration data for accurate weighing, Data for adapting to the operating environment, Control data for the RS-232C interface). There are five switches for the purpose of protecting these parameters. Each switch can select either “permit” or “inhibit”. The “inhibit” protects parameters against unintentional operations.

Switches

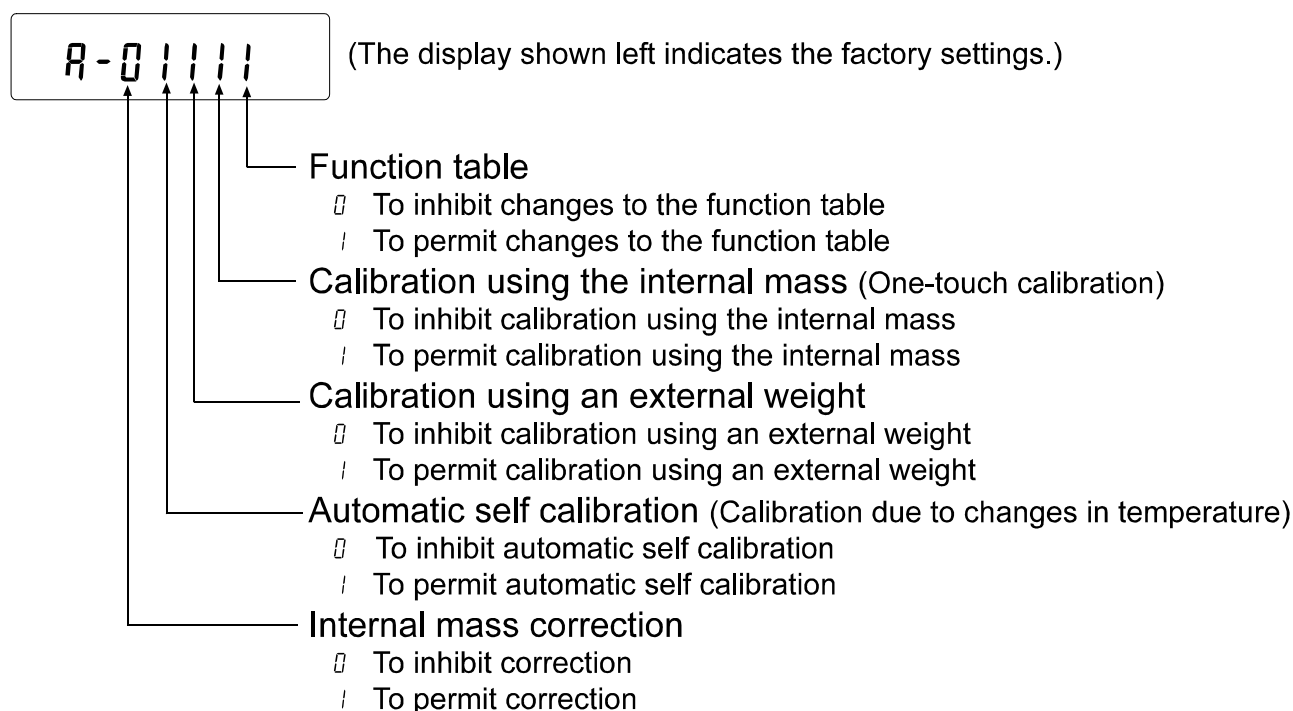

Operation

- 1 Press the **ON:OFF** key to turn off the display.
- 2 While pressing and holding the **PRINT** key and the **SAMPLE** key, press the **ON:OFF** key. The balance displays **P5**.
- 3 Press the **PRINT** key. Then the balance displays the function switches.
- 4 Set the switches using the following keys.
 - SAMPLE** key To select the switch to change the parameter. The selected switch blinks.
 - RE-ZERO** key To change the parameter of the switch selected.
 - :To inhibit changes./ Can not be used.
 - !:To permit changes./ Can be used.
 - PRINT** key To store the new parameter and return to the weighing mode.
 - CAL** key To cancel the operation and return to the weighing mode.

8-2 Initializing the Balance

This function returns the following parameters to factory settings.

- Calibration data
- Function table
- The sample unit mass value (counting mode), 100% reference mass value (percent mode)
- The data that is stored in the balance using the data memory function
- External calibration weight and target weight value
- Function switch settings
- Liquid density and temperature in the density mode

Note

Be sure to calibrate the balance after initialization.

Operation

- 1 Press the **ON:OFF** key to turn off the display.
- 2 While pressing and holding the **PRINT** key and the **SAMPLE** key, press the **ON:OFF** key. The balance displays **P5**.
- 3 Press the **SAMPLE** key to display **[Lr]**.
- 4 Press the **PRINT** key.
To cancel this operation, press the **CAL** key.
- 5 Press the **RE-ZERO** key.
- 6 Press the **PRINT** key to initialize the balance.

The balance will automatically return to the weighing mode.

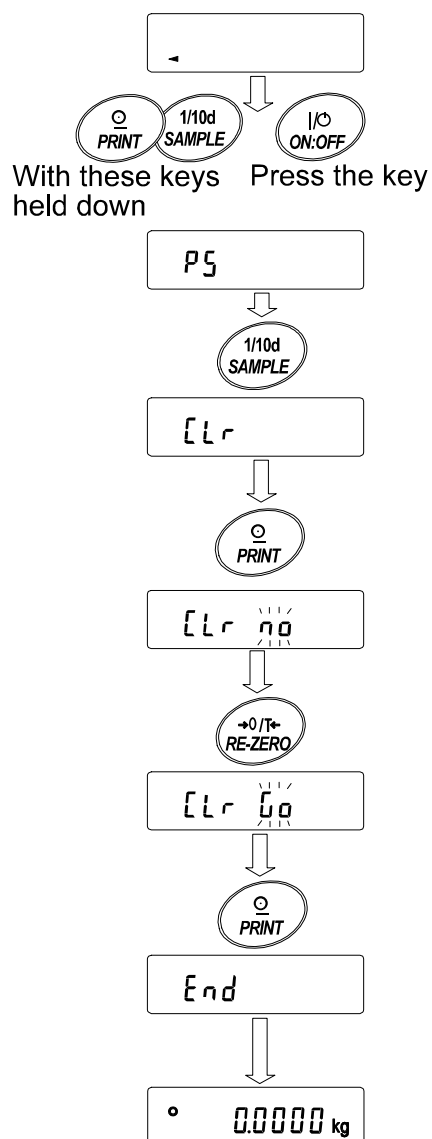

9. FUNCTION TABLE

The function table reads or rewrites the parameters that are stored in the balance. These parameters are maintained in non-volatile memory, even if the AC adapter is removed.

9-1 Structure and Sequence of the Function Table

The function table menu consists of two layers. The first layer is the “Class” and the second layer is the “Item”. Each item stores a parameter.

Example

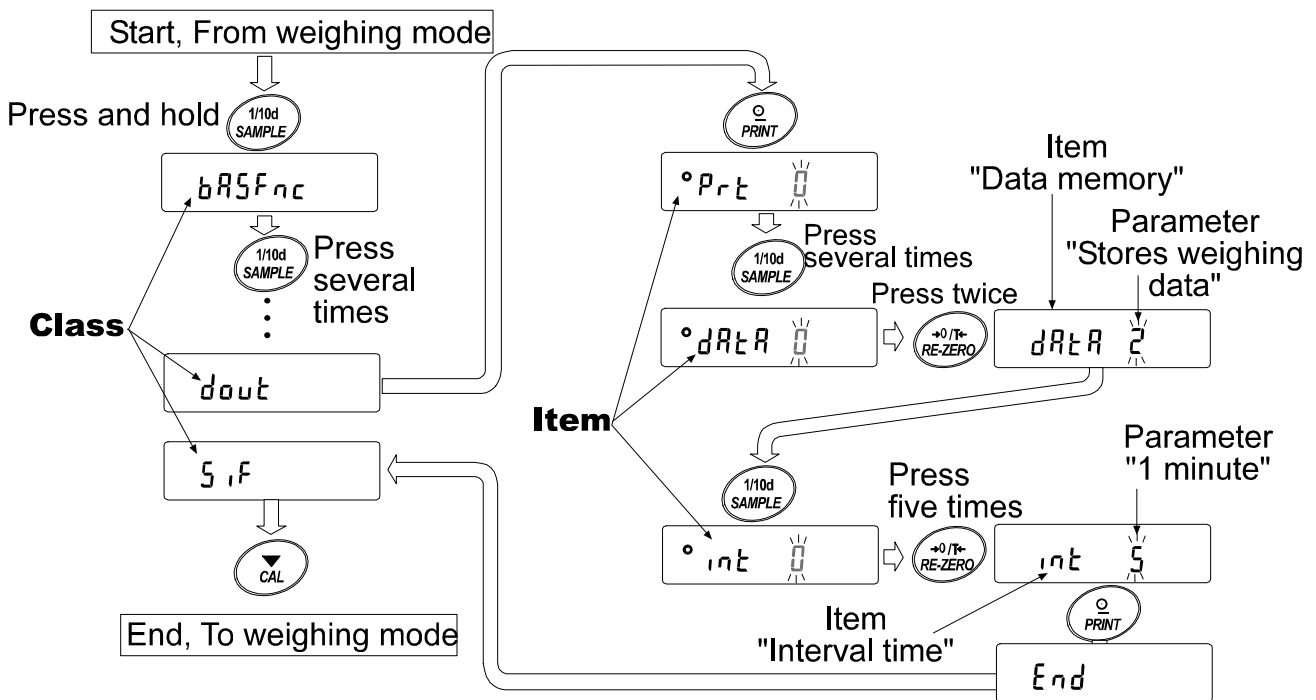

This example sets “Stores weighing data” for “Data memory” and “1 minute” for “Interval time”.



9-2 Display and Keys

Display/Key	Description
●	The symbol “●” indicates that the parameter displayed is in effect.
1/10d SAMPLE	When pressed and held in the weighing mode, enters the function table mode. Selects the class or item in the function table mode.
→0/T← RE-ZERO	Changes the parameter.
○ PRINT	When a class is displayed, moves to an item in the class. When an item is displayed, stores the new parameter and displays the next class.
▼ CAL	When an item is displayed, cancels the new parameter and displays the next class. When a class is displayed, exits the function table mode and returns to the weighing mode.

9-3 Details of the Function Table

Class	Item	Parameter	Description
bASFnC Environment Display	Cond Condition	0	Fast response, sensitive value <input type="checkbox"/> FAST
		1	
		2	Slow response, stable value <input type="checkbox"/> SLOW
	St-b Stability band width	0	Stable when within ± 1 digit
		1	
		2	Stable when within ± 3 digits
	Hold Hold function	0	OFF
		1	ON
	trc Zero tracking	0	OFF
		1	Normal
		2	Strong
		3	Very strong
	SPd Display refresh rate	0	5 times/second
		1	10 times/second
Pnt Decimal point	0	Point (.)	
	1	Comma (,)	
P-on Auto display-ON	0	OFF	
	1	ON	
POFF Auto display-OFF	0	OFF	
	1	ON (10 minutes)	
CSI Capacity indicator	0	OFF	
	1	ON	
Add Accumulation function	0	OFF	
	1	ON	
rnt Display at start	0	Does not display	
	1	Displays	
[L Add Clock			See "9-9 Clock and Calendar Function" Confirms and sets the time and date. The time and date are added to output data.
[P Fnc Comparator	[P Comparator mode	0	No comparison
		1	Comparison, excluding "near zero" when stable value or overloaded
		2	Comparison, including "near zero" when stable value or overloaded
		3	Continuous comparison, excluding "near zero"
		4	Continuous comparison, including "near zero"
	[P in Data input method	0	Sets the upper/lower limit values
		1	Sets the reference value
	[P-r Comparison results	0	Not added
		1	Added
	[P-b Main display comparison	0	OFF
1		ON	
Displayed only when Comparator output (OP-04) is installed.	bEP- LO buzzer	0	OFF
		1	ON
	bEP- OK buzzer	0	OFF
	1	ON	
	bEP- HI buzzer	0	OFF
		1	ON

▪ Factory setting **Note: "Digit" is a unit of minimum weighing value.**

Class	Item	Parameter	Description	
$[P H]$ Upper limit		See "9-10 Comparator Function"	Displayed when $[P in 0]$ is selected.	
$[P Lo]$ Lower limit				
$[P rEF]$ Reference value		See "9-10 Comparator Function"	Displayed when $[P in 1]$ is selected.	
$[P Lnt]$ Tolerance				
$dout$ Data output	Prt Data output mode	0	Key mode	Accepts the PRINT key only when the display is stable.
		1	Auto print mode A (Reference = zero)	Outputs data when the display is stable and
		2	Auto print mode B (Reference = last stable value)	conditions of $AP-P$, $AP-b$ and the reference value are met.
		3	Stream mode / Interval memory mode	With $dARA$ 0, outputs data continuously; with $dARA$ 2, uses interval memory.
	$AP-P$ Auto print polarity	0	Plus only	Displayed value > Reference
		1	Minus only	Displayed value < Reference
		2	Both	Regardless of displayed value
	$AP-b$ Auto print difference	0	10 digits	Difference between reference value and displayed value
		1	100 digits	
		2	1000 digits	
	$dARA$ Data memory	0	Not used	Related items: Prt , int , $d-no$, $S-tD$, $info$
		1	Stores unit mass in counting mode	
		2	Stores weighing data	
		3	Stores calibration data	
		4	Stores comparator settings	
	int Interval time	0	Every measurement	Interval time in the interval memory mode (with Prt 3, $dARA$ 2)
		1	2 seconds	
		2	5 seconds	
		3	10 seconds	
		4	30 seconds	
		5	1 minute	
		6	2 minutes	
		7	5 minutes	
	$d-no$ Data number output	0	No output	See "11. DATA MEMORY".
1		Output		
$S-tD$ Time/Date output	0	No output	Selects whether or not the time or date is added to the weighing data. For details, refer to "9-9 Clock and Calendar Function".	
	1	Time only		
	2	Date only		
$S-ID$ ID number output	0	No output	Selects whether or not the ID number is output.	
	1	Output		

▪ Factory setting

Class	Item	Parameter	Description		
<i>dout</i> Data output	<i>PUSE</i> Data output pause	▪ 0	No pause	Selects the data output interval.	
		1	Pause (1.6 seconds)		
	<i>At-F</i> Auto feed	▪ 0	Not used	Selects whether or not auto feed is performed.	
		1	Used		
<i>inFo</i> GLP output		▪ 0	No output	Selects GLP output method. For how to set time and date to be added, refer to "9-9 Clock and Calendar Function"	
		1	AD-8121 format		
		2	General data format		
<i>Ar-d</i> Zero after output		▪ 0	Not used	Adjusts zero automatically after data is output	
		1	Used		
<i>5IF</i> Serial interface	<i>bPS</i> Baud rate	0	600 bps		
		1	1200 bps		
		▪ 2	2400 bps		
		3	4800 bps		
		4	9600 bps		
		5	19200 bps		
	<i>btPr</i> Data bit, parity bit		▪ 0	7 bits, even	
			1	7 bits, odd	
			2	8 bits, none	
	<i>CrLF</i> Terminator		▪ 0	CR LF	CR: ASCII code 0Dh LF: ASCII code 0Ah
			1	CR	
	<i>tYPE</i> Data format		▪ 0	A&D standard format	See "9-6 Description of Item "Data Format".
			1	DP format	
2			KF format		
3			MT format		
4			NU format		
<i>t-UP</i> Timeout		0	No limit	Selects the wait time to receive a command.	
		▪ 1	1 second		
<i>ErEd</i> AK, Error code		▪ 0	No output	AK: ASCII code 06h	
		1	Output		
<i>cts</i> CTS, RTS control		▪ 0	Not used	Controls CTS and RTS.	
		1	Used		
<i>dS Fnc</i> Density function	<i>Ldin</i> Liquid density input	▪ 0	Water temperature	Available only when density mode is selected.	
		1	Liquid density		
<i>nLt</i> Programmable-unit (Multi-unit)		Sets an arbitrary coefficient.		Available only when programmable-unit mode is selected.	
<i>Unit</i> Unit		See "4. WEIGHING UNITS".			
<i>CS in</i> Internal mass value correction		See "7. CALIBRATION".		Displayed only when the internal mass value correction switch is set to 1.	
<i>id</i> ID number setting		See "10. ID NUMBER AND GLP REPORT".			

Caution

▪ Factory setting

The balance may not transmit the data completely at the specified refresh rate, depending on the baud rate or data added to the weighing data such as time, date and ID number.

9-4 Description of the Class “Environment, Display”

Condition (Cond)

$\text{Cond } 0$



$\text{Cond } 2$

This parameter is for sensitive response to the fluctuation of a weight value. Used for powder target weighing, weighing a very light sample or when quick response weighing is required. After setting, the balance displays **FAST**.

This parameter is for stable weighing with slow response. Used to prevent a weight value from drifting due to vibration or drafts. After setting, the balance displays **SLOW**.

Notes

In automatic response adjustment, the response rate is selected automatically.

With “Hold function (Hold)” set to “ON (1)”, this item is used to set the averaging time.

Stability band width (St-b)

This item controls the width to regard a weight value as a stable value. When the fluctuation per second is less than the parameter, the balance displays the stabilization indicator and outputs or stores the data. The parameter influences the “Auto print mode”

$\text{St-b } 0$



$\text{St-b } 2$

This parameter is for sensitive response of the stabilization indicator. Used for exact weighing.

This parameter ignores slight fluctuation of a weight value. Used to prevent a weight value from drifting due to vibration or drafts.

Note

With “Hold function (Hold)” set to “ON (1)”, this item is used to set the stabilization range.

Hold function (Hold) (Animal weighing mode)

This function is used to weigh a moving object such as an animal.

When the weighing data is over the weighing range from zero and the display fluctuation is within the stabilization range for a fixed period of averaging time, the processing indicator illuminates and the balance displays the average weight of the animal. When the animal is removed from the weighing pan, the display returns to zero automatically.

This function is available only when the hold function parameter is set to “1” (the animal mode indicator **ANIMAL** illuminates) and any weighing unit other than the counting mode is selected.

The stabilization range and averaging time are set in “Condition (Cond)” and “Stability band width (St-b)”.

Weighing range		Averaging time		Stabilization range		
GP-12K/20K	20 g	$\text{Cond } 0$	2 seconds	Faster	$\text{St-b } 0$	Small
GP-30K/30KS/32K/32KS/ 40K/61K/61KS		$\text{Cond } 1$	4 seconds		$\text{St-b } 1$	
		$\text{Cond } 2$	8 seconds	More accurate	$\text{St-b } 2$	Big
GP-60K/60KS/100K/100KS GP-102K	50 g					

Zero tracking (t_{rc})

This function tracks zero point drift caused by changes in the environment and stabilizes the zero point. When the weighing data is only a few digits, turn the function off for accurate weighing.

Note

Digit, when used for the GP series balance, indicates the smallest displayable weighing value.

$t_{rc} \ 0$	The tracking function is not used. Used for weighing a very light sample.
$t_{rc} \ 1$	The tracking function is used. Normal zero tracking.
$t_{rc} \ 2$	The tracking function is used. Strong zero tracking.
$t_{rc} \ 3$	The tracking function is used. Very strong zero tracking.

Display refresh rate (SPd)

Period to refresh the display. This parameter influences “Baud rate”, “Data output pause” and “Stream mode”.

Note

This item is selected automatically in the automatic response adjustment.

Decimal point (Pnt)

The decimal point format can be selected.

Auto display-ON ($P-on$)

When the AC adapter is plugged in, the display is automatically turned on without the ON:OFF key operation, to display the weighing mode. Used when the balance is built into an automated system. 30-minute warm up is necessary for accurate weighing.

Auto display-OFF ($P-off$)

When the AC adapter is connected and no operation is performed (inactivity state) for 10 minutes, the display is automatically turned off and the standby indicator illuminates.

Capacity indicator (CS_i)

In the weighing mode, the indicator displays the weighing data relative to the weighing capacity in percentage. (Zero = 0%, maximum capacity = 100%)

When the “Data memory ($dMEM$)” parameter is set to “1” (to store unit mass in the counting mode), “2” (to store the weighing data), “4” (to store comparator settings) or “5” (to store tare value), the indicator displays the information stored in memory, such as the amount of memory data or data number.

Accumulation function (Add)

The accumulation function adds the weighing data, displays and outputs the total value. For details, refer to “5-5 Accumulation Function.”

Display at start ($rn0$)

When the weighing accuracy is not so strict, the smallest displayable weighing value can be turned off without any key operation at weighing start. Useful when the balance is built into an automated system.

9-5 Description of the Item “Data output mode”

The parameter setting of “Data output mode (*Prt*)” applies to the performance when the “Data memory (*dMEm*)” parameter is set to “2” (to store the weighing data) and when the data is transmitted using the RS-232C interface.

Key mode

When the **PRINT** key is pressed with the stabilization indicator turned on, the balance outputs or stores the weighing data and the display blinks one time.

Required setting	<i>dout</i>	<i>Prt</i> 0	Key mode
------------------	-------------	--------------	----------

Auto print modes A and B

When the displayed value is stable and the conditions of “Auto print polarity”, “Auto print difference” and reference value are met, the balance outputs or stores the weighing data.

When the **PRINT** key is pressed with the stabilization indicator turned on, the balance outputs or stores the data and the display blinks one time.

Mode A: Required setting	<i>dout</i>	<i>Prt</i> 1	Auto print mode A (reference = zero)
	<i>dout</i>	<i>AP-P</i>	Auto print polarity
	<i>dout</i>	<i>AP-b</i>	Auto print difference
Example	“For weighing each time a sample is placed and removed, with “ <i>Ar-d</i> ” set to “1” (to adjust zero after the data is output).”		

Mode B: Required setting	<i>dout</i>	<i>Prt</i> 2	Auto print mode B (reference = last stable value)
	<i>dout</i>	<i>AP-P</i>	Auto print polarity
	<i>dout</i>	<i>AP-b</i>	Auto print difference
Example	“For weighing while a sample is added.”		

Stream mode

The balance outputs the weighing data continuously regardless of the display condition. The display does not blink in this mode. This mode is not available and the interval memory mode is used when the “Data memory (*dMEm*)” parameter is set to “2” (to store the weighing data).

Required setting	<i>dout</i>	<i>Prt</i> 3	Stream mode
	<i>dout</i>	<i>dMEm</i> 0	Data memory function is not used.
	<i>bRSFnc</i>	<i>SPd</i>	Display refresh rate
	<i>SIF</i>	<i>bPS</i>	Baud rate
Example	“For monitoring data on a computer”		

Caution

The balance may not transmit the data completely at the specified refresh rate, depending on the baud rate or data added to the weighing data such as time, date and ID number.

Interval memory mode

The weighing data is periodically stored in memory.

Required setting	<i>dout</i>	<i>Prt 3</i>	Interval memory mode
	<i>dout</i>	<i>DATA 2</i>	Data memory function is used. Stores weighing data.
	<i>dout</i>	<i>int</i>	Interval time
Optional setting	<i>dout</i>	<i>Std 1, 2, or 3</i>	Adds the time and date.
Example	"For periodical weighing without a computer command and to output all of the data, to a computer, at one time"		

9-6 Description of the Item "Data format"

A&D standard format *SIF TYPE 0*

This format is used when the peripheral equipment can receive the A&D format. If an AD-8121B is used, set the printer to MODE 1 or 2.

- This format consists of fifteen characters excluding the terminator.
- A header of two characters indicates the balance condition.
- The polarity sign is placed before the data with the leading zeros. If the data is zero, the plus sign is used.
- The unit, consisting of three characters, follows the data.

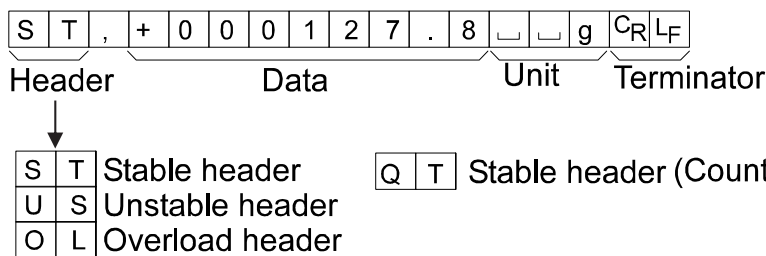

DP (Dump print) format *SIF TYPE 1*

This format is used when the peripheral equipment can not receive the A&D format. If an AD-8121B is used, set the printer to MODE 3.

- This format consists of sixteen characters excluding the terminator.
- A header of two characters indicates the balance condition. No overload header is used.
- The polarity sign is placed before the data, with spaces in place of leading zeros, if the data is not zero or overloaded.
- The unit, consisting of three characters, follows the data.

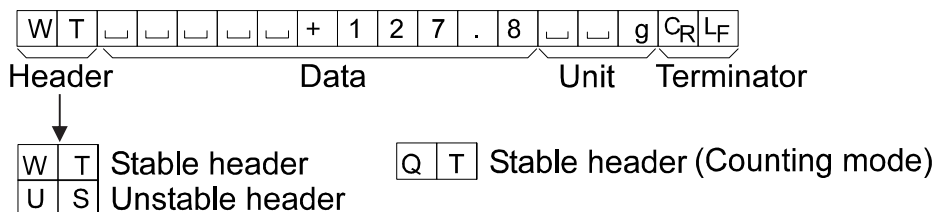

KF format *S, F TYPE 2*

This is the Karl-Fischer moisture meter format and is used when the peripheral equipment can only communicate using this format.

- This format consists of fourteen characters excluding the terminator.
- This format has no header characters.
- The polarity sign is placed before the data, with spaces in place of leading zeros, if the data is not zero or overloaded.
- This format outputs the unit only for a stable value.

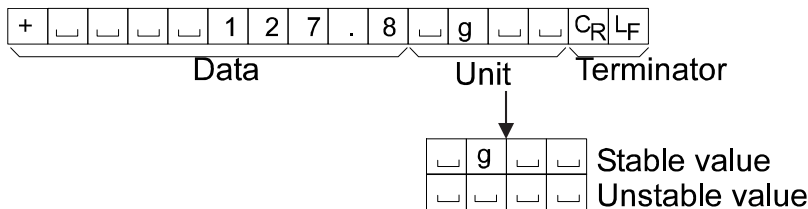

MT format *S, F TYPE 3*

- A header of two characters indicates the balance condition.
- The polarity sign is used only for negative data.
- The weighing data uses spaces in place of the leading zeros.
- The character length of this format changes dependent upon the unit

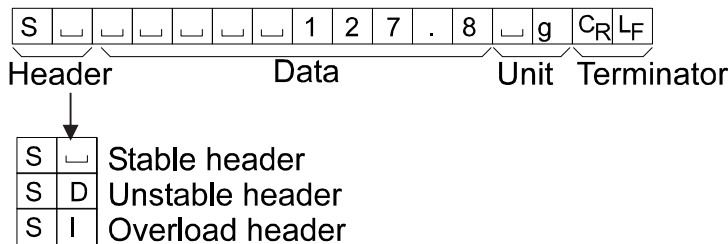

NU (numerical) format *S, F TYPE 4*

This format outputs only numerical data.

- This format consists of nine characters excluding the terminator.
- The polarity sign is placed before the data with the leading zeros. If the data is zero, the plus sign is used.

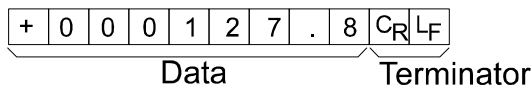

CSV format *S, F TYPE 5*

- Separates the data of A&D standard format and the unit by a comma (,).
- Outputs the unit even when the data is overloaded.
- When ID number, data number, time and date are added, outputs ID number, data number, date, time and weighing data in this order and separates each item by a comma and treats all the items as one group of data.

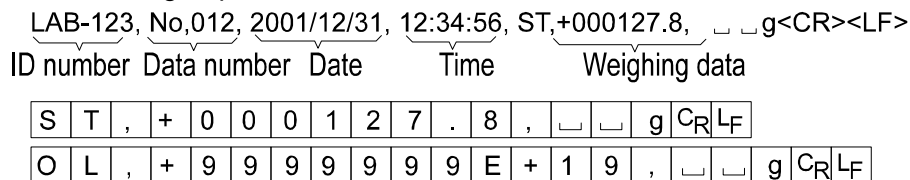

9-7 Description of the Data Format Added to the Weighing Data

ID number *dout 5-id 1*

The number to identify a specific balance.

- This format consists of seven characters excluding the terminator.

L	A	B	-	1	2	3	C _R	L _F
---	---	---	---	---	---	---	----------------	----------------

Data number *dout d-no 1*

This format outputs the data number just before the data is transmitted using the RS-232C interface.

- This format consists of six characters excluding the terminator.
- When CSV format (*5-if TYPE 5*) is selected, the period (.) is replaced with a comma (,).

N	o	.	0	0	1	C _R	L _F
---	---	---	---	---	---	----------------	----------------

Data number Terminator

Date *dout 5-td 2 or 3*

- The date output order can be changed in "Clock (*EL Add*)". Outputs the year in four-digit format.

2	0	0	1	/	1	2	/	3	1	C _R	L _F
---	---	---	---	---	---	---	---	---	---	----------------	----------------

Time *dout 5-td 1 or 3*

- Outputs time in 24-hour format.

1	2	:	3	4	:	5	6	C _R	L _F
---	---	---	---	---	---	---	---	----------------	----------------

Tare value

- When the tare value in memory is recalled, the tare value is output before the weighing data.

P	T	,	+	0	0	0	1	2	3	.	4	□	□	g	C _R	L _F
---	---	---	---	---	---	---	---	---	---	---	---	---	---	---	----------------	----------------

 Tare value

N	□	,	+	0	0	0	5	6	7	.	8	□	□	g	C _R	L _F
---	---	---	---	---	---	---	---	---	---	---	---	---	---	---	----------------	----------------

 Weighing data (Net value)

Comparison results

- By setting "Comparison results (*CP-r*)" of the function table to "1", the comparison results can be added to the data output using the RS-232C serial interface. Use A&D standard format (*TYPE 0*). The comparison results are added after the header in A&D standard format as below.

S	T	,	O	K	,	+	0	1	2	.	3	4	5	6	□	k	g	C _R	L _F
---	---	---	---	---	---	---	---	---	---	---	---	---	---	---	---	---	---	----------------	----------------

Header Comparison Data Unit Terminator
results



H	I	When the comparison result is HI
O	K	When the comparison result is OK
L	O	When the comparison result is LO
-	-	Not applicable

Note

When the data described above is added to the weighing data, the output is in the following order: ID number, Data number, Date, Time and Weighing data.

9-8 Data Format Examples

Stable

°	12.7	g
---	------	---

A&D	S	T	,	+	0	0	0	0	1	2	.	7			g	C _R	L _F	
DP	W	T							+	1	2	.	7			g	C _R	L _F
KF	+								1	2	.	7			g		C _R	L _F
MT	S								1	2	.	7			g		C _R	L _F
NU	+	0	0	0	0	1	2	.	7								C _R	L _F

Unstable

-1836.9	g
---------	---

A&D	U	S	,	-	0	0	1	8	3	6	.	9			g	C _R	L _F			
DP	U	S							-	1	8	3	6	.	9			g	C _R	L _F
KF	-								1	8	3	6	.	9					C _R	L _F
MT	S	D							-	1	8	3	6	.	9			g	C _R	L _F
NU	-	0	0	1	8	3	6	.	9									C _R	L _F	

Overload

Positive error

E	g
---	---

A&D	O	L	,	+	9	9	9	9	9	9	9	E	+	1	9			C _R	L _F		
DP																			C _R	L _F	
KF									H											C _R	L _F
MT	S	I	+																	C _R	L _F
NU	+	9	9	9	9	9	9	9	9	9										C _R	L _F

Overload

Negative error

-E	g
----	---

A&D	O	L	,	-	9	9	9	9	9	9	9	E	+	1	9			C _R	L _F			
DP												-	E							C _R	L _F	
KF												L									C _R	L _F
MT	S	I	-																		C _R	L _F
NU	-	9	9	9	9	9	9	9	9	9											C _R	L _F

␣ Space, ASCII 20h

C_R Carriage Return, ASCII 0Dh

L_F Line Feed, ASCII 0Ah

Units		A&D	D.P.	KF	MT
g	g	□□g	□□g	□g□□	□g
kg	kg	□kg	□kg	□kg□	□kg
Counting mode	pcs	□PC	□PC	□pc s	□PC S
Precent mode	%	□□%	□□%	□%□□	□%
Ounce (Avoir)	oz	□oz	□oz	□oz□	□oz
Pound	lb	□lb	□lb	□lb□	□lb
Pound Ounce	□ oz	□oz	□oz	□oz□	□oz
Troy Ounce	oz t	oz t	oz t	□oz t	□oz t
Metric Carat	ct	□ct	□ct	□ct□	□ct
Momme	mom	mom	mom	□mom	□mo
Pennyweight	dwt	dwt	dwt	□dwt	□dwt
Tael (HK general, Singapore)	TL	□t l	□t l	□t l s	□t l
Tael (HK, jewelry)	TL	□t l	□t l	□t l h	□t l
Tael (Taiwan)	TL	□t l	□t l	□t l t	□t l
Tael (China)	TL	□t l	□t l	□t l c	□t l
Tola (India)	t	□□t	□□t	□t o l	□t
Messghal	MS	m e s	m e s	□M S□	□m
Density	DS	□D S	□D S	□D S□	□D S
Multi	(Blank)	□□□	□□□	□□□□	□

□ Space, ASCII 20h

Note

When “Pound Ounce” is selected, the data is output with the unit of ounce (oz).

9-9 Clock and Calendar Function

The balance is equipped with a clock and calendar function. When the “GLP output (INF_o)” parameter is set to “1” or “2” and the “Time/Date output (S-t_d)” parameter is set to “1”, “2” or “3”, the time and date are added to the output data. Set or confirm the time and date as follows:

Operation

- 1 Press and hold the **SAMPLE** key until **bRSFnC** of the function table is displayed, then release the key.
- 2 Press the **SAMPLE** key several times to display **EL Adj.**
- 3 Press the **PRINT** key. The balance enters the mode to confirm or set the time and date.

Confirming the time

- 4 The current time is displayed with all the digits blinking.
 - When the time is correct and the date does not need to be confirmed, press the **CAL** key and proceed to step 8.
 - When the time is correct and the date is to be confirmed, press the **SAMPLE** key and proceed to step 6.
 - When the time is not correct and is to be changed, press the **RE-ZERO** key and proceed to step 5.

Setting the time (with part of the digits blinking)

- 5 Set the time in 24-hour format using the following keys.

SAMPLE key	To select the digits to change the value. The selected digits blink.
RE-ZERO key	To increase the value by one.
MODE key	To decrease the value by one.
PRINT key	To store the new setting, display End and go to step 6.
CAL key	To cancel the new setting and go to step 6.

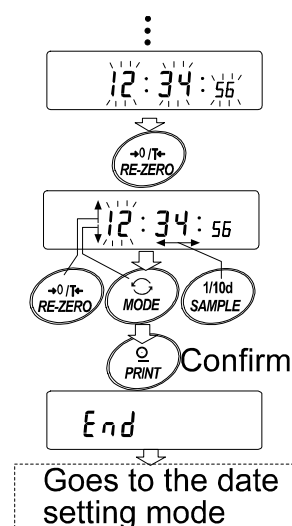

Confirming the date

- 6 The current date is displayed with all the digits blinking.
 - To change the display order of year (y), month (\bar{n}) and day (d), press the **MODE** key. The date is output in the order as specified.
 - When the date is correct and the operation is to be finished, press the **CAL** key and proceed to step 8.
 - When the time is to be confirmed again, press the **SAMPLE** key and go back to step 4.
 - When the date is not correct and is to be changed, press the **RE-ZERO** key and proceed to step 7.

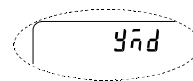

Note

The year is expressed using a two-digit format. For example, the year 2000 is expressed as "00".

Setting the date (with part of the digits blinking)

- 7 Set the date using the following keys.

SAMPLE key	To select the digits to change the value. The selected digits blink.
RE-ZERO key	To increase the value by one.
MODE key	To decrease the value by one.
PRINT key	To store the new setting, display End and go to step 8.
CAL key	To cancel the new setting and go to step 8.

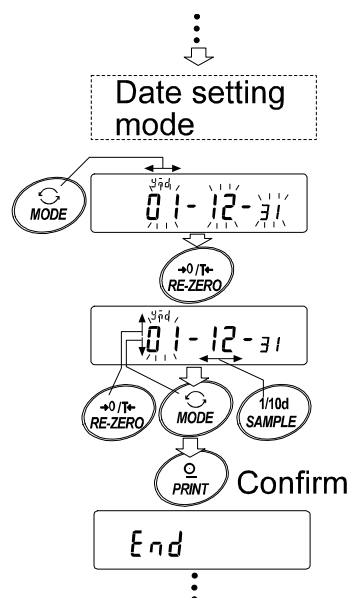

Quitting the operation

- 8 The balance displays the next menu item of the function table. Press the **CAL** key to exit the clock and calendar function and return to the weighing mode.

Notes

Do not enter invalid values such as a non-existing date when setting the time and date.

When the clock backup battery has been depleted, the balance displays **r t c P F**. Under this condition, press any key and set the time and date. The dead battery only affects the clock and calendar function. Even so, the function works normally as long as the AC adapter is connected to the balance.

9-10 Comparator Function

The results of the comparison are indicated by **HI** **OK** **LO** on the display.

Operating conditions:

- No comparison

- Comparison when the weighing data is stable or overloaded, excluding “near zero”
- Comparison when the weighing data is stable or overloaded, including “near zero”
- Continuous comparison, excluding “near zero”
- Continuous comparison, including “near zero”

To compare, use:

- Upper limit value and lower limit value
- Reference value and tolerance value

Input method:

- Digital input
- Weighing input

For a description of “Comparator mode ($[P Fnc]$)”, refer to “9-3 Details of the Function Table”.

“Near zero” means that the weighing data is within ± 10 digits from zero point.

Example: In case of GP-30K, the range of ± 1.0 g is “near zero”.

Setting example 1

(Comparison when the weighing data is stable or overloaded, excluding “near zero”, upper limit and lower limit)

Selecting a comparator mode

- 1 Press and hold the **SAMPLE** key until **bRSFnc** of the function table is displayed, then release the key.
- 2 Press the **SAMPLE** key several times to display **[P Fnc]**.
- 3 Press the **PRINT** key.
- 4 Press the **RE-ZERO** key several times to display **[P l]**.
- 5 Press the **SAMPLE** key to display **[P in]**.
- 6 Press the **RE-ZERO** key several times to display **[P in 0]**.
- 7 Press the **PRINT** key to store the selected mode.

Entering the upper and lower limit values

- 8 With **[P H l]** displayed, press the **PRINT** key. The current setting of the upper limit value is displayed with all of the digits blinking.
 - When the current setting is not to be changed, press the **PRINT** or **CAL** key to proceed to step 9.
 - When the current setting is to be changed, press the **RE-ZERO** key. The balance is now in the digital input mode. To use the weighing input mode, press and hold the **MODE** key.

Digital input mode

Change the setting using the following keys.

SAMPLE key	To select the digit to change the value.
RE-ZERO key	To change the value of the digit selected.
MODE key	To switch the polarity.
PRINT key	To store the new setting and go to step 9.
CAL key	To cancel the new setting and go to step 9.

Weighing input mode

Press the **RE-ZERO** key. The balance displays **00 g**. Place a sample, with a mass that corresponds to the upper limit value, on the pan. Press the **PRINT** key to store the upper limit value. Remove the sample. The balance displays **[P L0]**.

- 9 With **[P L0]** displayed, press the **PRINT** key. The current setting of the lower limit value is displayed with all of the digits blinking.
 - When the current setting is not to be changed, press the **PRINT** or **CAL** key to proceed to step 10.
 - When the current setting is to be changed, press the **RE-ZERO** key. The balance is now in the digital input mode. To use the weighing input mode, press and hold the **MODE** key. Enter the lower limit value in the same way as described in step 8. Then, go to step 10.
- 10 Press the **CAL** key to exit the comparator function and return to the weighing mode.

Setting example 2

(Continuous comparison, including “near zero”, reference value and tolerance value)

Selecting a comparator mode

- 1 Press and hold the **SAMPLE** key until **bRSFnC** of the function table is displayed, then release the key.
- 2 Press the **SAMPLE** key several times to display **[P Fnc]**.
- 3 Press the **PRINT** key.
- 4 Press the **RE-ZERO** key several times to display **[P 4]**.
- 5 Press the **SAMPLE** key to display **[P in]**.
- 6 Press the **RE-ZERO** key several times to display **[P in 1]**.
- 7 Press the **PRINT** key to store the selected mode.

Entering the reference and tolerance values

- 8 With **[P rEF]** displayed, press the **PRINT** key. The current setting of the reference value is displayed with all the digits blinking.
 - When the current setting is not to be changed, press the **PRINT** or **CAL** key to proceed to step 9.
 - When the current setting is to be changed, press the **RE-ZERO** key. The balance is now in the digital input mode. To use the weighing input mode, press and hold the **MODE** key.

Digital input mode

Change the setting using the following keys.

SAMPLE key	To select the digit to change the value.
RE-ZERO key	To change the value of the digit selected.
MODE key	To switch the polarity.
PRINT key	To store the new setting and go to step 9.
CAL key	To cancel the new setting and go to step 9.

Weighing input mode

Press the **RE-ZERO** key. The balance displays **00 g**. Place a sample, with a mass that corresponds to the reference value, on the pan. Press the **PRINT** key to store the reference value. Remove the sample and go to step 9.

- 9 With $[CP \ L \ \bar{n} \ t]$ displayed, press the $[PRINT]$ key. The current setting of the tolerance value is displayed with all the digits blinking.
- When the current setting is not to be changed, press the $[PRINT]$ or $[CAL]$ key to proceed to step 10.
 - When the current setting is to be changed, press the $[RE-ZERO]$ key. The balance is now in the digital input mode. Change the setting using the following keys.

$[SAMPLE]$ key	To select the digit to change the value.
$[RE-ZERO]$ key	To change the value of the digit selected.
$[PRINT]$ key	To store the new setting and go to step 10.
$[CAL]$ key	To cancel the new setting and go to step 10.

**Notes: Enter the tolerance value in percentage, with the reference value as 100%.
Only the digital input mode is available for setting the tolerance value.
The $[MODE]$ key is not used to set the tolerance value.**

- 10 Press the $[CAL]$ key to exit the comparator function and return to the weighing mode.

Notes

When Pound/Ounce is selected as a weighing unit, enter the values in ounces for comparison.

In the density mode, comparison is performed to the density obtained.

9-11 Adding the Comparison Results

By setting "Comparison results ($[P-r]$)" of the function table to "I", the comparison results can be added to the data output using the RS-232C serial interface. Use A&D standard format ($[TYPE \ 0]$).

The comparison results are added after the header in A&D standard format as below.

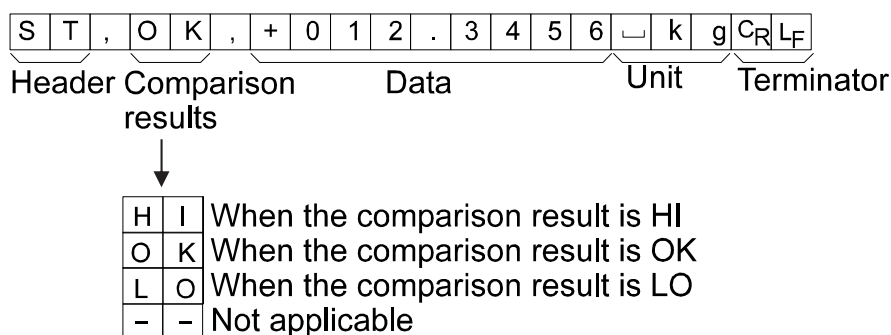

9-12 Main Display Comparison Function

The main display comparison function displays the comparison results in a magnified way, on the main portion of the display in place of the weight value.

Selecting a unit

- 1 Press the $[MODE]$ key to select a unit to be used for comparison.

Note

While the main display comparison function is in use, unit selection using the $[MODE]$ key is not available.

Setting the function table

- 2 Press and hold the **SAMPLE** key until **bRSFnC** of the function table is displayed, then release the key.
- 3 Press the **SAMPLE** key several times to display **[CP Fnc]**.
- 4 Press the **PRINT** key.
- 5 Press the **SAMPLE** key several times to display **[CP-b 0]**.
- 6 Press the **RE-ZERO** key to display **[CP-b 1]**.

Note

To disable the main display comparison function, set the “Main display comparison (CP-b)” parameter to “0”.

- 7 Press the **PRINT** key to store the setting.
- 8 Press the **CAL** key to return to the weighing mode.

Setting the comparator values

Setting the comparator values as described in the previous section.

Setting example (CP 3=Continuous comparison, excluding “near zero”)

Using the main display comparison function

- 1 Press the **RE-ZERO** key to set the display to zero.
- 2 Place a sample on the pan. The balance performs a comparison using the specified comparison values and displays the comparison results, **HI**, **OK** or **LO**.
- 3 Each time the **MODE** key is pressed, the balance switches between the standard display and the main display comparison. Note that “00” appears for **OK**.

Notes

While the main display comparison function is in use, the processing indicator illuminates as shown in the illustration.

If the comparison is not performed, for example, because the weight value is near zero or unstable, the balance displays the weight value even when the main display comparison function is used.

Even while the main display comparison function is in use, the balance re-zeroing and data output is possible.

Only the unit selected before this function can be used.

While the main display comparison function is in use, the data memory function is not available.

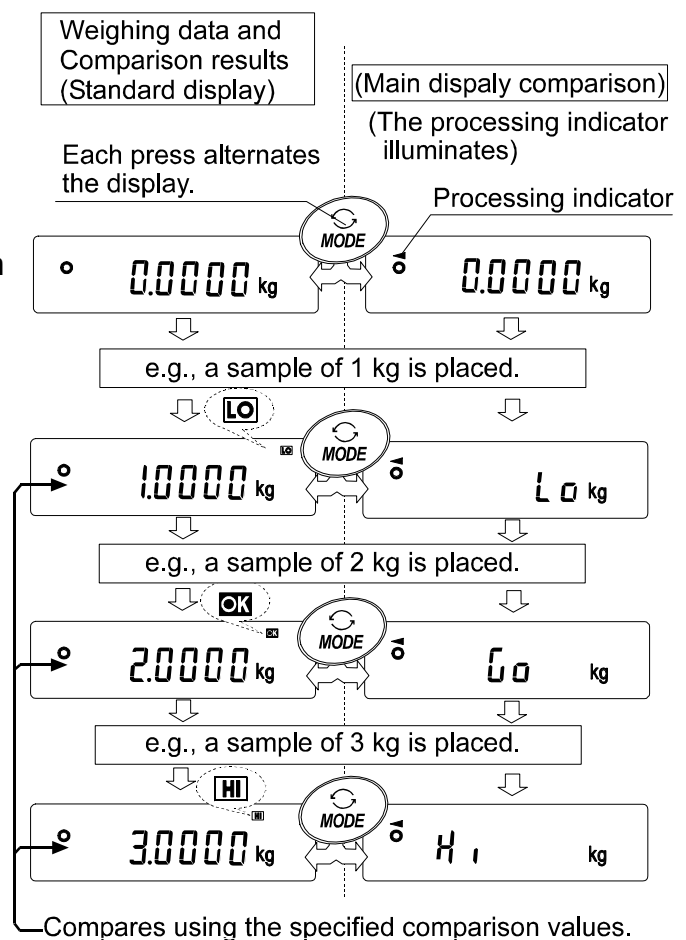

10. ID NUMBER AND GLP REPORT

- The ID number is used to identify the balance when Good Laboratory Practice (GLP) is used.
- The ID number is maintained in non-volatile memory even if the AC adapter is removed.
- The GLP output format is selected at “GLP output (*inf*o)” of the function table and can be output to a personal computer or printer using the RS-232C serial interface.
- The GLP output format includes the balance manufacturer, model, serial number, ID number, date, time and space for signature for weighing data, the weight used and results for calibration or calibration test data.
- The balance can output the following reports for GLP.
 - “Calibration report” of the calibration, using the internal mass (Calibration due to changes in temperature and one-touch calibration.)
 - “Calibration report” of the calibration, using an external weight.
 - “Calibration test report” of the calibration test, using an external weight.
 - “Title block” and “End block” for the weighing data.
- Calibration and calibration test data can be stored in memory to output several reports at the same time. Refer to “11. DATA MEMORY” for details.
- For details on confirming and setting the time and date, refer to “9-9 Clock and Calendar Function”.

10-1 Setting the ID Number

- 1 Press and hold the **SAMPLE** key until **bRSFnC** of the function table is displayed, then release the key.
- 2 Press the **SAMPLE** key several times to display **id**.
- 3 Press the **PRINT** key. Set the ID number using the following keys.
 - RE-ZERO** key To set the character of the digit selected. Refer to the display character set shown below.
 - SAMPLE** key To select the digit to change the value.
 - PRINT** key To store the new ID number and display **bRSFnC**.
 - CAL** key To cancel the new ID number and display **bRSFnC**.
- 4 With **bRSFnC** displayed, press the **CAL** key to return to the weighing mode.

Display character set

0	1	2	3	4	5	6	7	8	9	-	_	A	B	C	D	E	F	G	H	I	J	K	L	M	N	O	P	Q	R	S	T	U	V	W	X	Y	Z
0	1	2	3	4	5	6	7	8	9	-	_	A	B	C	D	E	F	G	H	I	J	K	L	M	N	O	P	Q	R	S	T	U	V	W	X	Y	Z

_ Space

10-2 GLP Report

Set the following parameters to output the report.

- To print the report, set the “GLP output (*info*)” parameter to “1” and use MODE 3 of the AD-8127. For details on using the printer, refer to “15-1 Connection to the AD-8127 Multi Printer”.
- To output the report to a personal computer using the RS-232C interface, set the “GLP output (*info*)” parameter to “2”.
- If the time and date are not correct, set the correct time and date in “Clock (*CL Adj*)” of the function table.

Note

For operational details about calibration and calibration test, refer to “7. CALIBRATION”.

Calibration report using the internal mass

When the setting is “ *info 1* ”:

```

AD-8121 format
                A & D
MODEL          GP-30K
S/N           01234567
ID            ABCDEFG
DATE          2000/12/31
TIME          12:34:56
CALIBRATED<INT.>
SIGNATURE
    
```

When the setting is “ *info 2* ”:

```

General data format
.....A_&_D<TERM>
MODEL.....GP-30K<TERM>
S/N.....01234567<TERM>
ID.....ABCDEFG<TERM>
DATE<TERM>
.....2000/12/31<TERM>
TIME<TERM>
.....12:34:56<TERM>
CALIBRATED (INT.)<TERM>
SIGNATURE<TERM>
<TERM>
<TERM>
-----<TERM>
<TERM>
<TERM>
    
```

← Manufacturer →
 ← Model →
 ← Serial number →
 ← ID number →
 ← Date →
 ← Time →
 ← Calibration type →
 ← Signature →

□ Space, ASCII 20h

<TERM> Terminator, C_R, L_F or C_R

C_R Carriage return, ASCII 0Dh

L_F Line feed, ASCII 0Ah

Calibration report using an external weight

When the setting is "info 1":

When the setting is "info 2":

AD-8121 format

```

      A & D
MODEL      GP-30K
S/N        01234567
ID          ABCDEFG
DATE       2000/12/31
TIME       12:34:56
CALIBRATED(EXT.)
CAL.WEIGHT
      +20000.0 9
SIGNATURE
-----
    
```

← Manufacturer →
 ← Model →
 ← Serial number →
 ← ID number →
 ← Date →
 ← Time →
 ← Calibration type →
 ← Calibration weight →
 ← Signature →

General data format

```

.....A_&_D<TERM>
MODEL.....GP-30K<TERM>
S/N.....01234567<TERM>
ID.....ABCDEFG<TERM>
DATE<TERM>
.....2000/12/31<TERM>
TIME<TERM>
.....12:34:56<TERM>
CALIBRATED(EXT.)<TERM>
CAL.WEIGHT<TERM>
.....+20000.0_g<TERM>
SIGNATURE<TERM>
<TERM>
<TERM>
-----<TERM>
<TERM>
<TERM>
    
```

└ Space, ASCII 20h

<TERM> Terminator, C_R, L_F or C_R
 C_R Carriage return, ASCII 0Dh
 L_F Line feed, ASCII 0Ah

Calibration test report using an external weight

(Calibration test does not perform calibration.)

When the setting is "info 1":

When the setting is "info 2":

AD-8121 format

```

      A & D
MODEL      GP-30K
S/N        01234567
ID          ABCDEFG
DATE       2000/12/31
TIME       12:34:56
CAL.TEST(EXT.)
ACTUAL
      0.0 9
      +19999.9 9
TARGET
      +20000.0 9
SIGNATURE
-----
    
```

← Manufacturer →
 ← Model →
 ← Serial number →
 ← ID number →
 ← Date →
 ← Time →
 ← Calibration test type →
 ← Zero point value →
 ← Target weight value →
 ← Target weight →
 ← Signature →

General data format

```

.....A_&_D<TERM>
MODEL.....GP-30K<TERM>
S/N.....01234567<TERM>
ID.....ABCDEFG<TERM>
DATE<TERM>
.....2000/12/31<TERM>
TIME<TERM>
.....12:34:56<TERM>
CAL.TEST(EXT.)<TERM>
ACTUAL<TERM>
.....0.0_g<TERM>
.....+19999.9_g<TERM>
TARGET<TERM>
.....+20000.0_g<TERM>
SIGNATURE<TERM>
<TERM>
<TERM>
-----<TERM>
<TERM>
<TERM>
    
```

└ Space, ASCII 20h

<TERM> Terminator, C_R, L_F or C_R
 C_R Carriage return, ASCII 0Dh
 L_F Line feed, ASCII 0Ah

Title block and end block

When weight values are recorded as GLP data, a “Title block” is inserted at the beginning and an “End block” is inserted at the end of a group of weight values in the GLP report.

Note

To output the report to an AD-8121B , use **MODE 3** of the AD-8121B.

Caution

If the data memory function is used, the “Title block” and “End block” can not be output.

Operation

- 1 With the weighing data displayed, press and hold the **PRINT** key, then release the key. **Start** is displayed. The “Title block” is output.
- 2 The weighing data is output according to the parameter setting of the data output mode.
- 3 Press and hold the **PRINT** key until **End** is displayed, then release the key. The “End block” is output.

When the setting is “info 1”:

When the setting is “info 2”:

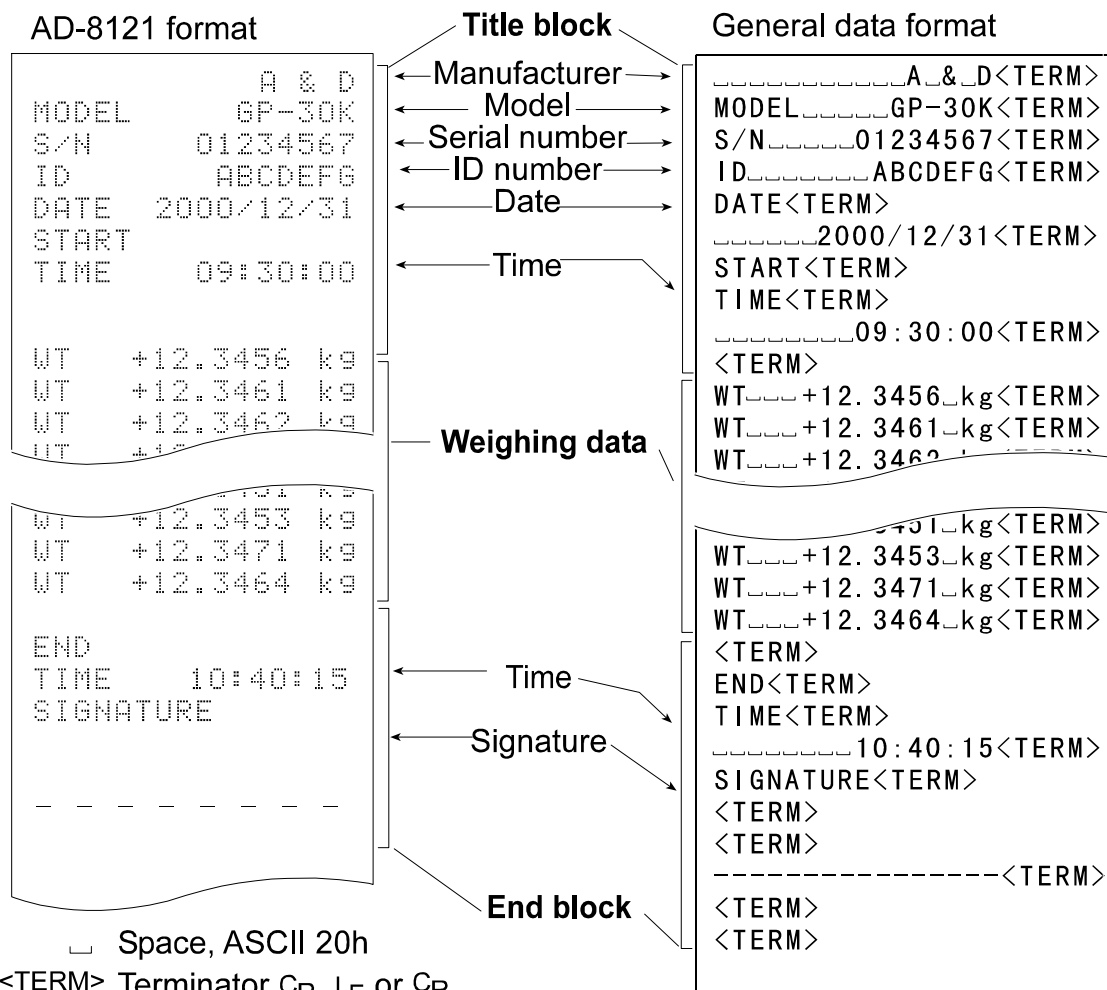

11. DATA MEMORY

Data memory is a function to store weighing data, calibration data and unit mass in memory. Of the data in memory, the balance can only display the weighing data. The weighing data and calibration data in memory are available for outputting at one time to a printer or personal computer.

One of the following data sets can be stored:

- Weighing data (Up to 200 sets. 100 sets when the time and date are added.)
- Calibration and calibration test data (latest 50 sets)
- Unit mass in the counting mode (Up to 50 sets)
- Comparator settings (the upper and lower limit values only, up to 20 sets)
- Tare value (Up to 20 sets)

11-1 Notes on Using Data Memory

To use the memory function, set the “Data memory (*dAtA*)” parameter of the function table. In addition, for weighing data, set the “Time/Date output (*S-t d*)” parameter. For details on setting the data memory, refer to “9. FUNCTION TABLE”.

For weighing data, the data contents to be stored and the storage capacity depend on the “Time/Date output (*S-t d*)” parameter setting.

Releasing “[Lr]”

If a different type of data exists in memory when the data is stored, “[Lr]” appears blinking in the upper left of the display. For example, you want to store weighing data but calibration data or unit mass data remains in memory.



Under such a condition, before storing data, delete the data in memory as follows:

- 1 Press and hold the **PRINT** key until [Lr no] with “no” blinking is displayed, then release the key.
- 2 Press the **RE-ZERO** key to display [Lr 00] with “00” blinking.

The type of data stored in memory appears in the upper left of the display as shown below:

Unit mass in the counting mode	PC
Weighing data without time and date	-d-
Weighing data with time and date	d-t
Calibration or calibration test data	HIS
Comparator settings	CP
Tare value	tr

- 3 Press the **PRINT** key to delete all the data in memory.
- 4 The balance displays [End] and returns to the weighing mode.

11-2 Memory for Weighing Data

- The data memory function can store 200 sets of weighing data (100 set if time and date are added). Even if the AC adapter is removed, the data is maintained in non-volatile memory.
- It is not necessary that the printer or computer be continually connected to the balance, because the balance stores the weighing data in memory.
- The data in memory is available to be displayed on the balance for confirmation, or to output several sets of data at one time to a printer or personal computer. In the function setting, what data is to be added to the output data (ID number, data number, time and date) can be selected.

Storing the weighing data

Note

If “**Err**” appears blinking in the upper left of the display, delete the data in memory.

- 1 Set the “Data memory (dAtA)” parameter to “2”.
- 2 Set the “Time/Date output (S-t d)” parameter as necessary.
- 3 The storing operation depends on the “Data output mode (P-r-t)” parameter setting. Four types of operating modes are available to store data.

Key mode	When the PRINT key is pressed and the displayed value is stable, the balance stores the weighing data.
Auto print modes A and B	When the displayed value is stable and the conditions of “Auto print polarity”, “Auto print difference” and reference value are met, the balance stores the weighing data.
Interval memory mode	Weighing data is stored at an interval specified in “Interval time (int)”. Press the PRINT key to start and stop this mode.

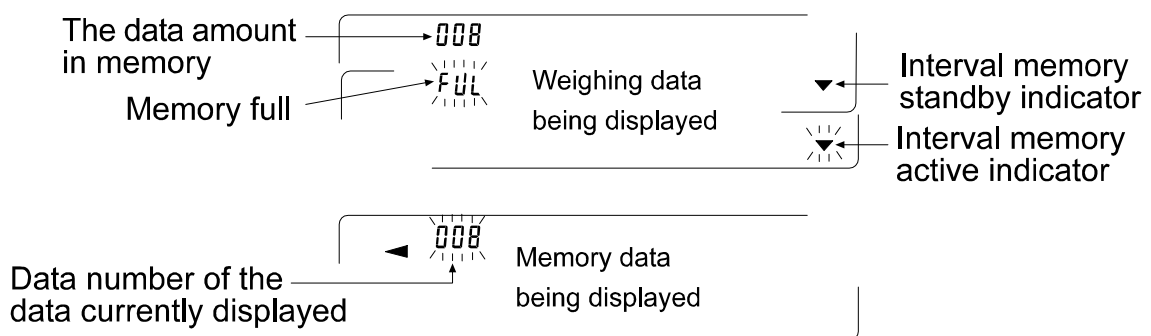

Caution

- When weighing data is being stored in memory, the data can not be output to a personal computer using the RS-232C interface.
- “FUL” indicates that memory is full or the memory capacity has been reached. More data can not be stored unless the memory data is deleted.
- Automatic self calibration can not be used while the interval memory mode is active.

- The following commands can not be used during data storage.

- Q Query command for weighing data.
- S Query command for stable weighing data.
- SI Query command for weighing data.
- SIR Query command for continuous weighing data.

Setting the function table

Parameter settings for each output mode are as follows:

Item \ Mode	Data output mode	Auto print polarity, difference	Data memory function	Interval time
Key mode	<i>Pr t 0</i>	Not used	<i>dAtA 2</i>	Not used
Auto print mode A	<i>Pr t 1</i>	<i>AP-A 0-2</i>	<i>dAtA 2</i>	
Auto print mode B	<i>Pr t 2</i>	<i>AP-b 0-2</i>	<i>dAtA 2</i>	
Interval memory mode	<i>Pr t 3</i>	Not used	<i>dAtA 2</i>	<i>int 0-8</i>

Set each item, depending on the situation, as follows:

Data number	No	<i>d-no 0</i>	Time and date	No	<i>5-td 0</i>
	Yes	<i>d-no 1</i>		Time only	<i>5-td 1</i>
ID number	No	<i>5-id 0</i>		Date only	<i>5-td 2</i>
	Yes	<i>5-id 1</i>		Both	<i>5-td 3</i>

With *5-td 1*, *5-td 2* or *5-td 3* selected, the amount of data to be stored is 100 sets.

Enabling the data memory function

- 1 Press and hold the **SAMPLE** key until **bASFnC** is displayed, then release the key.
- 2 Press the **SAMPLE** key several times to display **dout**.
- 3 Press the **PRINT** key.
- 4 Press the **SAMPLE** key three times to display **dAtA 0**.
- 5 Press the **RE-ZERO** key to display **dAtA 2**.
- 6 Press the **PRINT** key to store the setting.
- 7 Press the **CAL** key to return to the weighing mode.

Recalling the memory data

Confirm that the “Data memory (dAtA)” parameter is set to “2”.

- 1 Press and hold the **PRINT** key until **rECALL** is displayed, then release the key.
- 2 Press the **PRINT** key to enter the memory recall mode. The type of data appears in the upper left of the display as shown to the right:

Recall the data in memory using the following keys

- | | |
|--------------------|---|
| RE-ZERO key | To proceed to the next data set. |
| MODE key | To go back to the previous data set. |
| PRINT key | To transmit the current data using the RS-232C interface. |

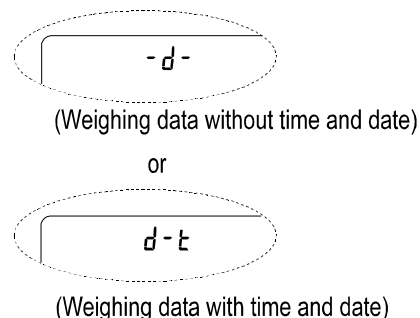

- With **SAMPLE** held down, press the **CAL** key
To delete the data currently displayed.

Note: Deleting the data will not increase the number of data that can be stored.

- CAL** key To exit the memory recall mode.

- 3 Press the **CAL** key to return to the weighing mode.

Transmitting all memory data at one time

Confirm that the “Serial interface (SIF)” parameters are set properly. For details, refer to “9. FUNCTION TABLE” and “15. CONNECTION TO PERIPHERAL EQUIPMENT”.

- 1 Press and hold the **PRINT** key until **rECALL** is displayed, then release the key.
- 2 Press the **SAMPLE** key to display **out**.
- 3 Press the **PRINT** key to display **out no** with “no” blinking.
- 5 Press the **RE-ZERO** key to display **out 00** with “00” blinking.
- 6 Press the **PRINT** key to transmit all data using the RS-232C interface.
- 7 The balance displays **CLER** when all data is transmitted.
Press the **CAL** key to return to the weighing mode.

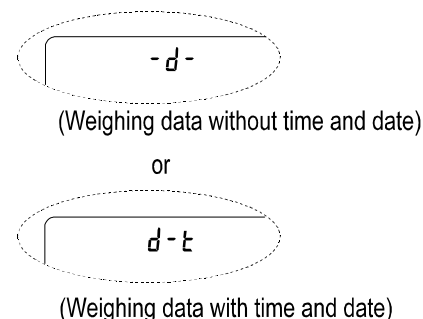

Deleting all memory data at one time

- 1 Press and hold the **PRINT** key until **rECALL** is displayed, then release the key.
- 2 Press the **SAMPLE** key several times to display **CLER**.
- 3 Press the **PRINT** key to display **CLr no** with “no” blinking.
- 4 Press the **RE-ZERO** key to display **CLr 00** with “00” blinking.
- 5 Press the **PRINT** key to delete all data
- 6 The balance displays **End**, then **rECALL** when all data is deleted.
- 7 Press the **CAL** key to return to the weighing mode.

11-3 Memory for Calibration and Calibration Test Data

- Calibration data (when and how it is performed) and calibration test data can be stored in memory.
- All the data in memory is available to be output at one time to a printer or personal computer.
- Up to 50 data sets of the latest calibration or calibration test can be stored. When the memory capacity has been reached, “FUL” illuminates in the upper left of the display as shown below.

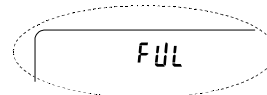

Storing the calibration and calibration test data

Note

If “CLR” appears blinking in the upper left of the display, delete the data in memory.

Store the calibration and calibration test data as follows:

- 1 Set the “Data memory (dAtA)” parameter to “3”.
- 2 Set the “GLP output (inFd)” parameter to “1” or “2”.
- 3 With the settings above, each time calibration or calibration test is performed, the data is stored automatically.

Transmitting the memory data

Confirm that the “Serial interface (SIF)” parameters are set properly. For details, refer to “9. FUNCTION TABLE” and “15. CONNECTION TO PERIPHERAL EQUIPMENT” and also confirm that the “Data memory (dAtA)” parameter is set to “3”.

- 1 Press and hold the **PRINT** key until **out** is displayed, then release the key.
- 2 Press the **PRINT** key to display **out no** with “no” blinking.
- 3 Press the **RE-ZERO** key to display **out 00** with “00” blinking.
- 4 Press the **PRINT** key to transmit all memory data using the RS-232C interface.
- 5 The balance displays **CLRr** when all memory data is output. Press the **CAL** key to return to the weighing mode.

In the upper left of the display

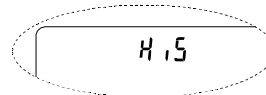

Deleting the memory data

- 1 Press and hold the **PRINT** key until **out** is displayed, then release the key.
- 2 Press the **SAMPLE** key to display **CLRr**.
- 3 Press the **PRINT** key to display **CLR no** with “no” blinking.
- 4 Press the **RE-ZERO** key to display **CLR 00** with “00” blinking.
- 5 Press the **PRINT** key to delete all data
- 6 The balance displays **out** when all the data has been deleted. Press the **CAL** key to return to the weighing mode.

In the upper left of the display

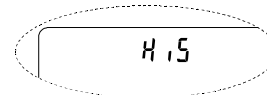

11-4 Memory for Unit Mass in the Counting Mode

- The data memory function can store 50 sets of unit mass for the counting mode. Even if the AC adapter is removed, the data is maintained in non-volatile memory. Among the 50 sets, “P01” is the memory function for the standard counting mode.
- The unit mass in memory can be recalled and used for weighing.
- The unit mass in memory can be recalled and changed.

Note

The recalled unit mass can be changed, using the weighing input mode or the digital input mode. The weighing input mode uses the specified number of samples to store the unit mass. The digital input mode enters the unit mass using the keys.

Storing the unit mass

To store a new unit mass: Recall the stored unit mass to be changed (“P01” to “P50”). Then, change the recalled unit mass using the weighing input mode or the digital input mode, and store the new unit mass.

- 1 Set the “Data memory (DATA)” parameter to “1”.
- 2 Press the **MODE** key to select **pcs** (counting mode).
If “**CLR**” appears blinking in the upper left of the display, delete the data in memory.

Note

If the counting mode can not be selected, refer to “4. WEIGHING UNITS”.

- 3 Press and hold the **PRINT** key until the balance enters the sample unit mass confirmation mode. The unit mass last selected is displayed as shown below.

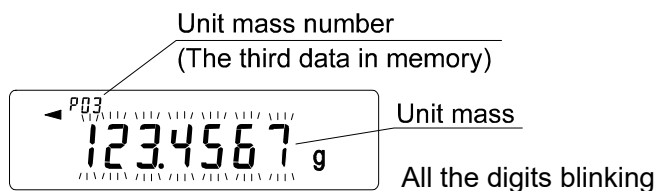

- 4 Select the unit mass number to be used, using the following keys.

RE-ZERO key To increase the unit mass number by one.
MODE key To decrease the unit mass by one.

- 5 To change the selected unit mass:

To use the weighing input mode, press the **SAMPLE** key to enter the weighing input mode. Go to “Weighing input mode” on the next page.

To use the digital input mode, press the **SAMPLE** key, then press and hold the **MODE** key to enter the digital input mode. Go to “Digital input mode” on the next page.

Notes

ACAI can not be performed directly on the recalled unit mass.

Using the “UN:mm” command, the unit mass can be recalled. (mm indicates a two-digit numerical value 01-50, which corresponds to P01-P50.) The unit mass recalled can be output using the “?UW” command and can be changed using the “UW:” command.

Weighing input mode

In the weighing input mode, the specified number of samples is placed on the pan to store the unit mass. Re-storing the unit mass or performing Automatic Counting Accuracy Improvement (ACAI) on the re-stored unit mass is possible. Follow the procedure described in “5-2 Counting Mode (PCS)”.

Use the following keys to store a unit mass in weighing input mode.

RE-ZERO key	To set the display to zero. 10 - pcs → 10 0 pcs
SAMPLE key	To change the number of samples to be stored. 10 0 pcs → 25 0 pcs
PRINT key	Press, after a sample is placed, to store the unit mass.
CAL key	To return to the unit mass confirmation mode (step 3 in “Recalling the unit mass”).
MODE key	Press and hold to go to the digital input mode.

Digital input mode

To use this mode, the sample unit mass must be known beforehand. In the digital input mode, the unit mass value is entered digitally using the keys.

The display in the digital input mode is shown to the right.

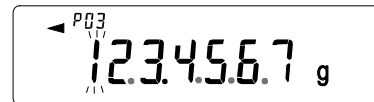

The digit to be changed blinks.

Note

ACAI can not be used on the unit mass stored using the digital input mode.

Use the following keys to store a unit mass in digital input mode.

SAMPLE key	To select the digit to be changed.
RE-ZERO key	To change the value of the selected digit.
MODE key	To change the decimal point position.
PRINT key	To store the unit mass.
CAL key	To return to the unit mass confirmation mode (step 3 in “Recalling the unit mass”).
MODE key	Press and hold to go to the weighing input mode.

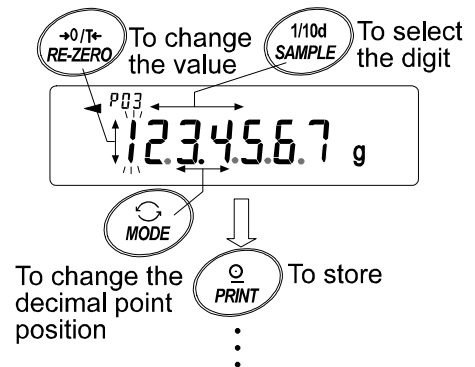

Note

If the set unit mass is out of the setting range, “Error 2” is displayed. For details about the minimum unit mass, refer to “19. SPECIFICATIONS”.

Recalling the unit mass

- Follow steps 1 through 3 in “Storing the unit mass” on the previous page, to enter the sample unit mass confirmation mode.
- Select the unit mass number to be used, using the following keys.

RE-ZERO key	To increase the unit mass number by one.
MODE key	To decrease the unit mass by one.

- Press the **PRINT** key to confirm the selection and to return to the weighing mode. To cancel the selection and return to the weighing mode, press the **CAL** key.

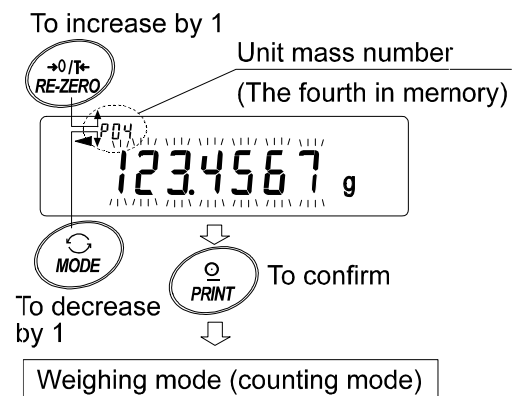

11-5 Memory for Comparator Settings

- The data memory function can store 20 sets of upper and lower limit values for the comparator mode. The reference value or tolerance value for the comparator mode can not be stored in memory.
- The upper and lower limit values in memory can be recalled easily using the **MODE** key and used for weighing.
- The upper and lower limit values in memory can be recalled and changed.

Note

The recalled upper and lower limit values can be changed, using the digital input mode or the weighing input mode. The digital input mode enters the upper and lower limit values using the keys. The weighing input mode uses a sample to store the upper and lower limit values.

Storing the upper and lower limit values

To store new upper and lower limit values: Recall the stored upper and lower limit values to be changed (“0.0” to “0.20”). Then, change the recalled upper and lower limit values using the digital input mode or the weighing input mode, and store the new value.

- 1 Press the **MODE** key to select a unit to be used for storage.

Note

While the data memory function is in use, unit selection using the **MODE** key is not available.

- 2 Set the “Data memory (dAtA)” parameter to “4”.
If “Lr” appears blinking in the upper left of the display, delete the data in memory as described in “11-1 Notes on Using Data Memory”.
- 3 Press and hold the **PRINT** key until the balance enters the upper and lower limit values confirmation mode. The upper limit value last selected is displayed as shown below.

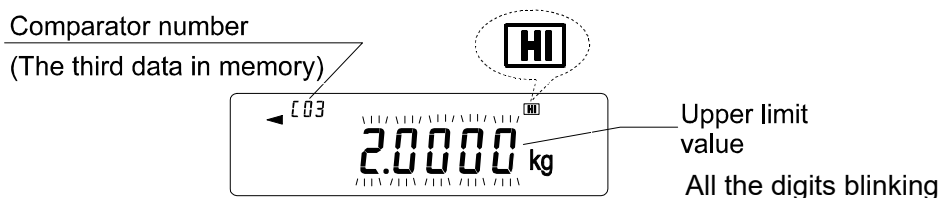

- 4 Select the comparator number to be used, using the following keys.

RE-ZERO key

To increase the comparator number by one.

MODE key

To decrease the comparator number by one.

Each time the **RE-ZERO** key or **MODE** key is pressed, the displayed value changes as follows: ... ↔ 03 **HI** ↔ 03 **LO** ↔ 04 **HI** ↔ 04 **LO** ↔ ...

- 5 To change the selected upper and lower limit values:

To use the digital input mode, press the **SAMPLE** key to enter the digital input mode. Go to “Digital input mode” on the next page.

To use the weighing input mode, press the **SAMPLE** key, then press and hold the **MODE** key to enter the weighing input mode. Go to “Weighing input mode” on the next page.

Note

Using the “CN:mm” command, the upper and lower limit values can be recalled. (mm indicates a two-digit numerical value 01-20, which corresponds to C01-C20.) The upper and lower limit values recalled can be output using the “?HI” command or “?LO” command and can be changed using the “HI:” command or “LO:” command.

Digital input mode

In the digital input mode, the upper and lower limit values are entered digitally using the keys.

The display in the digital input mode is shown below.

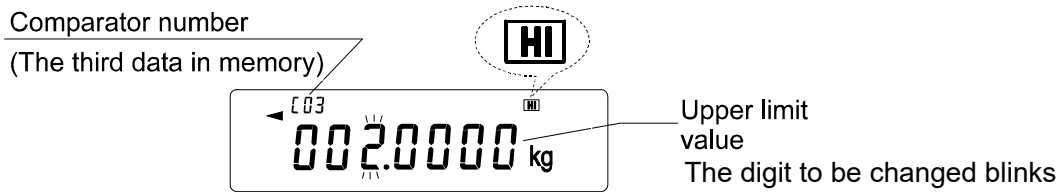

Use the following keys to store upper and lower limit values in digital input mode.

- SAMPLE** key To select the digit to be changed.
- RE-ZERO** key To change the value of the selected digit.
- MODE** key To switch the polarity.
- PRINT** key To store the upper and lower limit values.
- CAL** key To return to the upper and lower limit values confirmation mode (step 3 in “Storing the upper and lower limit values”).
- MODE** key Press and hold to go to the weighing input mode.

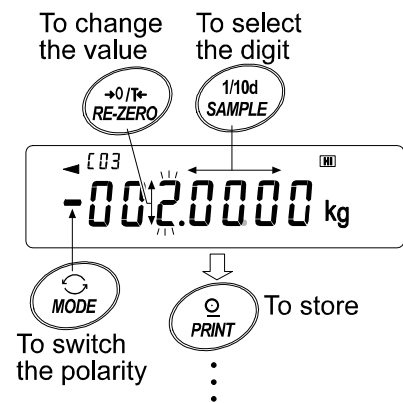

Weighing input mode

In the weighing input mode, a sample is placed on the pan to store the upper and lower limit values.

Notes

Pressing the **CAL** key will interrupt the operation and the balance will return to the upper and lower limit values confirmation mode (step 3 in “Storing the upper and lower limit values”).

To go to the digital input mode, press and hold the **MODE** key.

- 1 The first display in the weighing input mode depends on the comparator number selected in step 4 in “Storing the upper and lower limit values”.
For example, when “[03] [HI]” is selected in step 4, the display is the current weight value and the comparator number with [HI] blinking.
- 2 Place a container on the weighing pan, if necessary.
Press the **RE-ZERO** key to set the display to zero.
- 3 Place a sample corresponding to the upper limit value, on the pan or in the container.
- 4 Press the **PRINT** key to store the upper limit value.

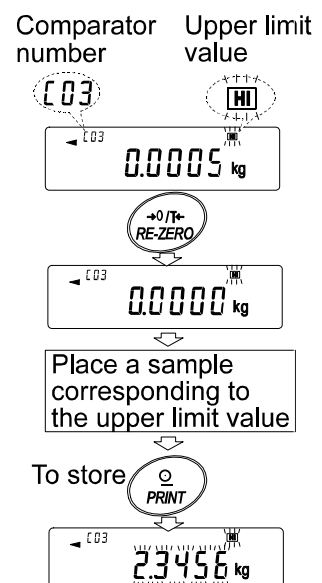

Recalling the upper and lower limit values (Quick selection mode)

The procedure below describes an easy way to recall the upper and lower limit values to be used for weighing. When the recalled upper and lower limit values are to be changed, refer to “Storing the upper and lower limit values”.

- 1 Set the “Data memory (*dAtA*)” parameter to “4”.
- 2 Press the **MODE** key to enter the upper/lower limit value recalling mode. The upper limit value last selected with its comparator number appears. The display is as shown to the right, with all the digits blinking.
- 3 Press the **MODE** key to select the value. Each time the **MODE** key is pressed, the displayed value changes as follows: $[03] [HI] \rightarrow [03] [LO] \rightarrow [04] [HI] \rightarrow [04] [LO] \rightarrow \dots \rightarrow [20] [LO] \rightarrow [01] [HI] \rightarrow$.
- 4 Press the **PRINT** key to confirm the selection. The balance returns to the weighing mode with the selected upper and lower limit values ready for use.

To cancel the selection, press the **CAL** key. The balance returns to the weighing mode.

Note

When no operation is performed in step 4 (after a few seconds of inactivity), the balance selects the value currently displayed and returns to the weighing mode automatically.

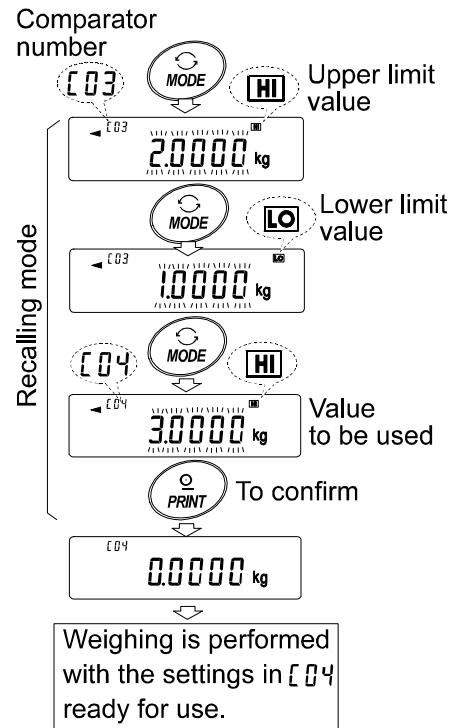

11-6 Memory for Tare Value

- The data memory function can store 20 sets of tare value for weighing.
- The tare value in memory can be recalled easily using the **MODE** key and used for weighing.
- The tare value in memory can be recalled and changed.

Notes

The recalled tare value can be changed, using the digital input mode or the weighing input mode. The digital input mode enters the tare value using the keys. The weighing input mode uses a sample tare container to store the tare value.

The NET indicator illuminates during tare operation.

Storing the tare value

To store a new tare value: Recall the stored tare value to be changed (“t01” to “t20”). Then, change the recalled tare value using the digital input mode or the weighing input mode, and store the new value.

Notes

When the **RE-ZERO** key is pressed with nothing placed on the weighing pan, zero is displayed, The NET indicator does not illuminate.

“t - - ” appears when a tare operation is performed without using the tare value stored in memory.

- 1 Press the **MODE** key to select a unit to be used for storage.

Note

While the data memory function is in use, unit selection using the **MODE** key is not available.

- 2 Set the “Data memory (dAtA)” parameter to “5”.
If “Lr” appears blinking in the upper left of the display, delete the data in memory as described in “11-1 Notes on Using Data Memory”.
- 3 Press and hold the **PRINT** key until the balance enters the tare value confirmation mode. The tare value last selected is displayed as shown below.

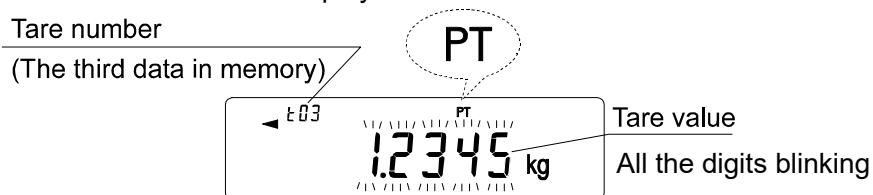

- 4 Select the tare number to be used, using the following keys.

RE-ZERO key	To increase the tare number by one.
MODE key	To decrease the tare number by one.
	Each time the RE-ZERO key or MODE key is pressed, the displayed value changes as follows: ↔ t03 ↔ t04 ↔ ↔ t20 ↔ t01 ↔
CAL key	To cancel the operation and return to the weighing mode.

- 5 To change the selected tare value:

To use the weighing input mode, press the **SAMPLE** key to enter the weighing input mode. Go to “Weighing input mode” on the next page.

To use the digital input mode, press the **SAMPLE** key, then press and hold the **MODE** key to enter the digital input mode. Go to “Digital input mode” on the next page.

Note

Using the “PN:mm” command, the tare value can be recalled. (mm indicates a two-digit numerical value 01-20, which corresponds to t01-t20.) The tare value recalled can be output using the “?PT” command and can be changed using the “PT:” command.

Weighing input mode

In the weighing input mode, a sample tare container is placed on the pan to store the tare value.

Notes

Pressing the **CAL** key will interrupt the operation and the balance will return to the tare value confirmation mode (step 3 in “Storing the tare value”).

To go to the digital input mode, press and hold the **MODE** key.

- 1 The first display in the weighing input mode is the current weight value and the selected tare number with **PT** blinking.
- 2 Press the **RE-ZERO** key to set the display to zero.
- 3 Place a tare (a container) on the pan.
- 4 Press the **PRINT** key to store the tare value. Remove the tare from the pan.

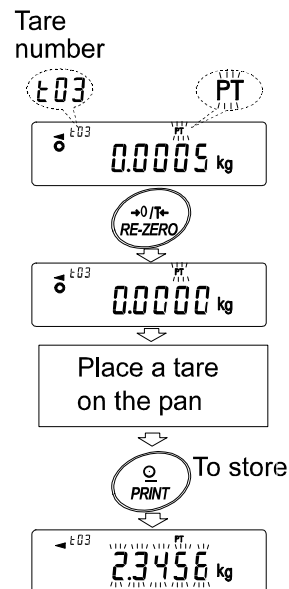

Digital input mode

In the digital input mode, the tare value is entered digitally using the keys.

The display in the digital input mode is shown below.

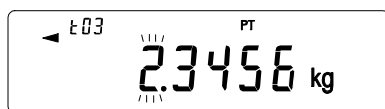

The digit to be changed blinks.

Use the following keys to store a tare value in digital input mode.

- | | |
|--------------------|---|
| SAMPLE key | To select the digit to be changed. |
| RE-ZERO key | To change the value of the selected digit. |
| PRINT key | To store the tare value. |
| CAL key | To return to the tare value confirmation mode (step 3 in “Storing the tare value”). |
| MODE key | Press and hold to go to the weighing input mode. |

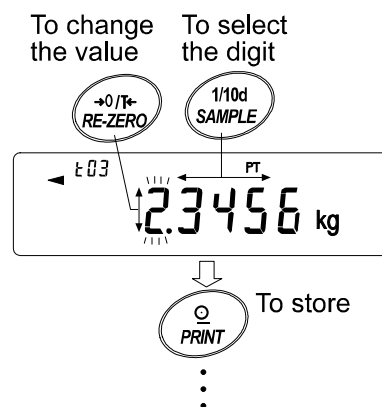

Recalling the tare value (Quick selection mode)

The procedure below describes an easy way to recall the tare value to be used for weighing. When the recalled tare value is to be changed, refer to “Storing the tare value”.

- 1 Set the “Data memory (dAtA)” parameter to “5”.
- 2 Press the **MODE** key to enter the tare value recalling mode. The tare value last selected with its tare number appears. The display is as shown to the right, with all the digits blinking.
- 3 Press the **MODE** key to select the value. Each time the **MODE** key is pressed, the displayed value changes as follows: $\epsilon 03 \rightarrow \epsilon 04 \rightarrow \epsilon 05 \rightarrow \dots \rightarrow \epsilon 20 \rightarrow \epsilon 01 \rightarrow$.
- 4 Press the **PRINT** key to confirm the selection. The balance returns to the weighing mode with the selected tare value ready for use.

To cancel the selection, press the **CAL** key. The balance returns to the weighing mode.

Note

When no operation is performed in step 4 (after a few seconds of inactivity), the balance selects the value currently displayed and returns to the weighing mode automatically.

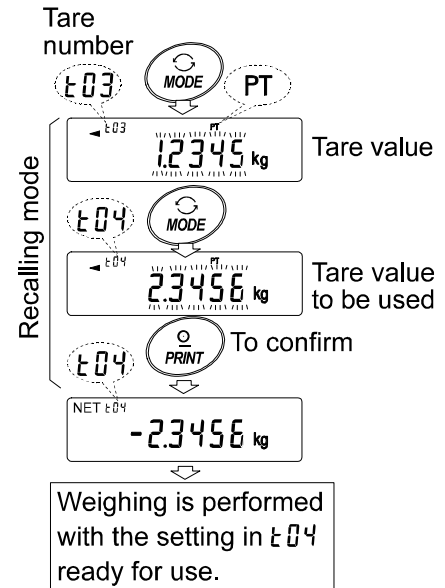

Canceling the tare value data

Cancel the tare value data as follows.

- 1 Remove everything from the weighing pan and press the **RE-ZERO** key to cancel the tare value.

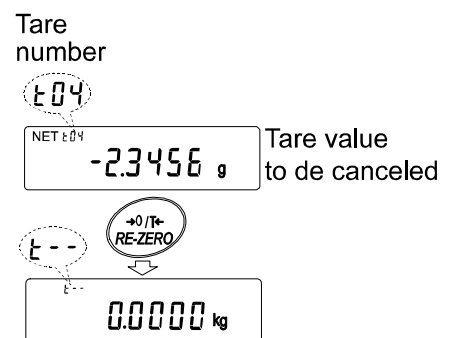

11-7 Data Memory: Quick Selection Mode

The data memory has a quick selection mode, to recall data in memory quickly.

Using the quick selection mode, the comparator settings or the tare value, whichever is selected in the function table, can be recalled, by a simple operation, using the **MODE** key.

Note

While the data memory function is in use, unit selection using the **MODE** key is not available.

Use the quick selection mode as follows.

- 1 Press the **MODE** key to enter the memory data recalling mode. The memory data last selected appears with all the digits blinking.
- 2 Press the **MODE** key to select the value.

Comparator settings: when the "Data memory (dAtA)" parameter is set to "4"

Each time the **MODE** key is pressed, the displayed value changes as follows:

....**03** **HI** → **03** **LO** → **04** **HI** → **04** **LO** → →
→ **20** **LO** → **01** **HI** →....

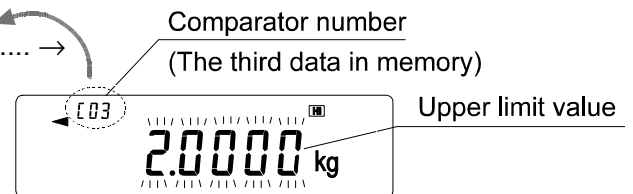

Tare value: when the "Data memory (dAtA)" parameter is set to "5"

Each time the **MODE** key is pressed, the displayed value changes as follows:

....**03** → **04** → **05** → → **20** → **01** →....

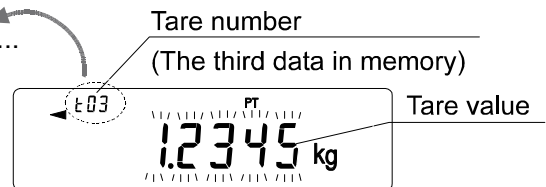

- 3 Press the **PRINT** key or leave the balance as is for a while (after a few seconds of inactivity) to confirm the selection. The balance returns to the weighing mode with the selected data ready for use.

To cancel the selection, press the **CAL** key. The balance returns to the weighing mode

11-8 Data Memory: Confirmation and Storage Mode

The confirmation and storage mode can change and store the recalled data.

Of the three types of memory data listed below, one may be selected in the function table, and is available for changes using this mode.

- Unit mass in the counting mode
- Comparator settings
- Tare value

Notes

To change the memory data other than specified in the function table, re-set the Data memory (dAtA) parameter of the function table.

For a detailed description of the procedure for each memory data, see the relevant section.

Use the confirmation and storage mode as follows.

- 1 Press and hold the **PRINT** key to enter the memory data recalling mode. The memory data last selected appears with all the digits blinking.

- 2 Use the following keys to select the value.

RE-ZERO key To increase the memory data number by one.

MODE key To decrease the memory data number by one.

Unit mass: when the "Data memory (dAtA)" parameter is set to "1"

Each time the **MODE** key or **RE-ZERO** key is pressed, the displayed value changes as follows:

... P03 ↔ P04 ↔ P05 ↔ ... ↔ P20 ↔ P01 ↔ ...

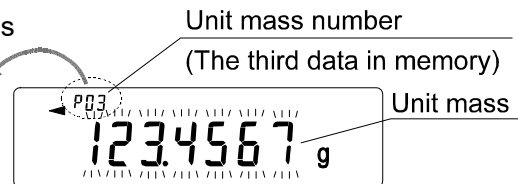

Comparator settings: when the "Data memory (dAtA)" parameter is set to "4"

Each time the **MODE** key or **RE-ZERO** key is pressed, the displayed value changes as follows:

... C03 HI ↔ C03 LO ↔ C04 HI ↔ C04 LO ↔ ...

↔

↔ C20 LO ↔ C01 HI ↔ ...

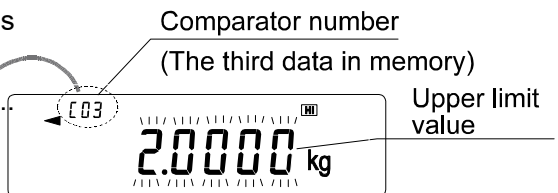

Tare value: when the "Data memory (dAtA)" parameter is set to "5"

Each time the **MODE** key or **RE-ZERO** key is pressed, the displayed value changes as follows:

... t03 ↔ t04 ↔ t05 ↔ ... ↔ t20 ↔ t01 ↔ ...

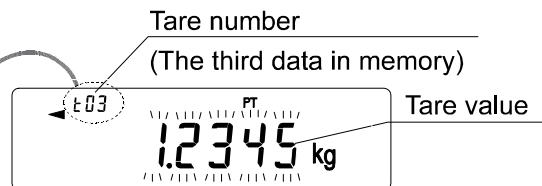

- 3 To perform a weighing using the selected memory data

Press the **PRINT** key to confirm the selection. The balance will return to the weighing mode with the selection ready for use.

To change and store the selected memory data

Press the **SAMPLE** key to enter the storage mode.

Two inputting modes are available for entering the value to be stored.

- Digital input mode
- Weighing input mode

To switch the inputting mode, press and hold the **MODE** key.

To cancel the operation and return to the weighing mode, press the **CAL** key.

12. PROGRAMMABLE-UNIT

This is a programmable unit conversion function. It multiplies the weighing data in kilograms by an arbitrary coefficient set in the function table and displays the result.

The coefficient must be within the range between the minimum and maximum shown below. If the coefficient set is beyond the range, an error is displayed and the balance returns to the coefficient setting mode, prompting to enter an appropriate value. A coefficient of 1 was set at the factory.

Model	Minimum coefficient	Maximum coefficient
GP-12K/20K/30K/30KS/40K/61K/61KS	0.000001	10000
GP-60K/60KS/100K/100KS		1000
GP-32K/32KS		1000
GP-102K		100

Operation

- 1 Press and hold the **SAMPLE** key until **bRSFnC** of the function table is displayed, then release the key.
- 2 Press the **SAMPLE** key several times to display **nLt**.
- 3 Press the **PRINT** key. The balance enters the mode to confirm or set the coefficient.

Confirming the coefficient

- 4 The current coefficient is displayed with the first digit blinking.
 - When it is not to be changed, press the **CAL** key and proceed to step 6.
 - When it is to be changed, press the **RE-ZERO** key and proceed to step 5.

Setting the coefficient

- 5 Set the coefficient using the following keys.

SAMPLE key	To select a digit to change the value. The selected digit blinks.
RE-ZERO key	To change the value.
MODE key	To change the decimal point position.

Each time the switch is pressed, the decimal point position changes as follows:

→ 0.000001 → 00.00001 → ... → 000000.1 → 0000001 →

PRINT key	To store the new setting, display End and go to step 6.
CAL key	To cancel the new setting and go to step 6.

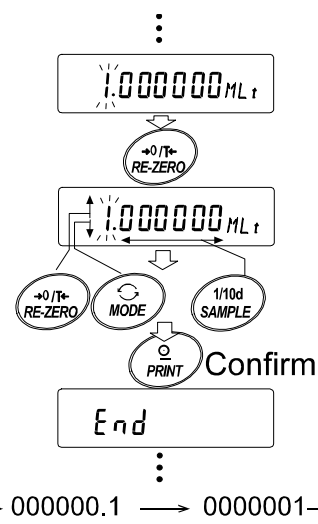

Quitting the operation

- 6 The balance displays **Unit**. Press the **CAL** key to exit the programmable-unit function and return to the weighing mode.

Using the function

Press the **MODE** key to select the programmable-unit (no display on the unit section). Perform weighing as described in "5-1 Basic Operation (Kilogram Mode)". After weighing, the balance displays the result (weighing data in kilograms x coefficient).

13. DENSITY MEASUREMENT

The GP series balance is equipped with a density mode. It calculates the density of a solid using the weight of a sample in air and the weight in liquid.

- The density mode was not selected for use when the balance was shipped from the factory. To use the mode, change the function table and activate the density mode.
- Inputting order, of the parameters necessary for density measurement, can be changed.
- A part of the parameters can be changed and used for re-calculating the density. Press the **SAMPLE** key to confirm or select each parameter. The parameters are stored in non-volatile memory. Each time a part of the parameters are changed, the density can be re-calculated.
- Two ways to set the density of a liquid are available in the function table, “Liquid density input (*Ld in*)”: by entering the water temperature or by entering the density directly.
- When the density mode is selected, the response adjustment and self check function can not be used.

Formula to obtain the density

The density can be obtained by the following formula.

$$\rho = \frac{A}{A - B} \times \rho_0$$

Where ρ : Density of a sample
 A: Weight value of a sample in air
 B: Weight value of a sample in liquid
 ρ_0 : Density of a liquid

Prior to measurement: Changing the function table

Prior to measurement, change the function table as follows.

(1) Selecting the density mode

To use the density mode, select it in the function table. Once selected, the density mode is available as one of the weighing units and can be selected by pressing the **MODE** key. For details, refer to “4-2 Changing the Units”.

(2) Selecting a way to set the density of a liquid

Select the liquid density input method from the function table below. The function table is available only when the density mode is selected.

Class	Item	Parameter	Description
<i>dS Fnc</i> Density function	<i>Ld in</i> Liquid density input	\emptyset	Water temperature
		<i>l</i>	Liquid density

\emptyset = Factory setting

Measuring the density

Note

If the liquid temperature or the type of liquid is changed during measurement, reset the value of the liquid density as necessary. For details, refer to “C. Entering the density of a liquid.”

(1) Entering the density mode

- 1 Press the **MODE** key as necessary to select the density mode. When the density mode begins, “*d-R*” (weight in air), “g (kg for the GP-102K)” for the unit and the processing indicator are turned on.

(2) Selecting a parameter to set.

- 1 Press the **SAMPLE** key to select a parameter to set. Each pressing of the key switches the parameter.
- 2 Press the **RE-ZERO** key to enter the inputting mode of the parameter selected.

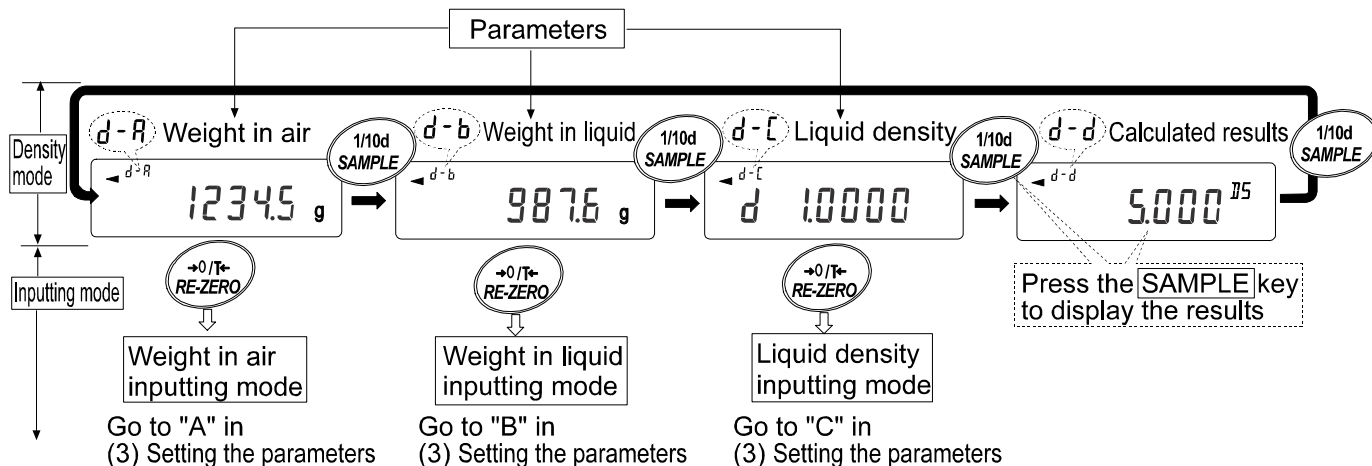

(3) Setting the parameter.

A. Entering the weight of a sample in air.

- 1 Confirm that nothing is placed on the upper pan (in air). Press the **RE-ZERO** key to set the display to zero.
- 2 Place a sample on the upper pan. When the value displayed on the balance becomes stable, press the **PRINT** key. The sample weight in air is confirmed and the balance will return to the density mode (the condition of step 1, (2) Selecting a parameter to set).
- 3 Remove the sample from the upper pan.

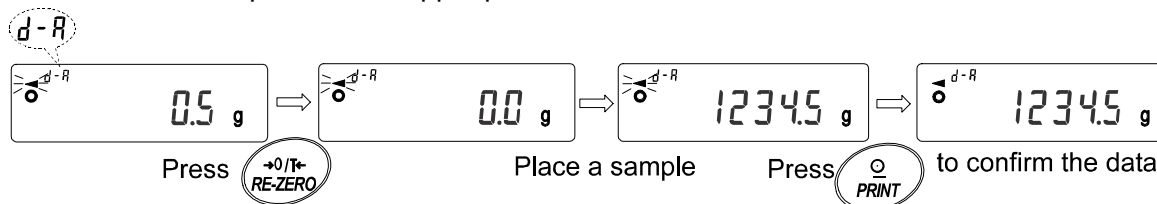

Notes

If an unstable value, a negative value or E (error) is displayed, the **PRINT** key is disabled.
 The **SAMPLE** key can not be used to change the minimum weighing value.

B. Entering the weight of a sample in liquid.

- 1 Confirm that nothing is placed on the lower pan (in liquid). Press the **RE-ZERO** key to set the display to zero.
- 2 Place a sample on the lower pan (in liquid). When the value displayed on the balance becomes stable, press the **PRINT** key. The sample weight in liquid is confirmed and the balance will return to the density mode (the condition of step1, (2) Selecting a parameter to set).
- 3 Remove the sample from the lower pan.

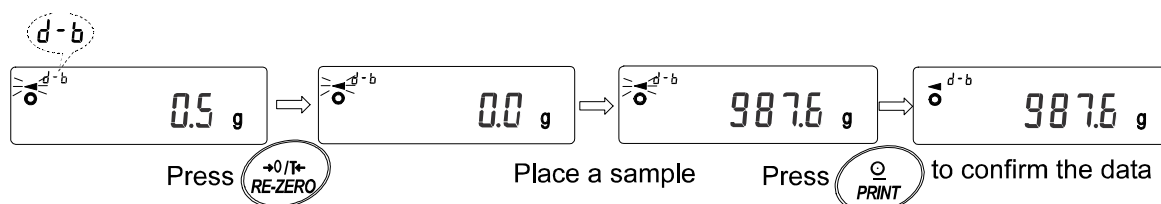

Notes

If an unstable value or E (error) is displayed, the **PRINT** key is disabled.
 The **SAMPLE** key can not be used to change the minimum weighing value.

C. Entering the density of a liquid.

Two ways to set the density of a liquid are available in the function table, Liquid density input (Ld_{in}): by entering the water temperature or by entering the density directly.

- Enter the water temperature ($Ld_{in} \text{ } \bar{t}$)

The water temperature currently set (unit: °C, factory setting : 25°C) is displayed.



Use the following keys to change the value.

- RE-ZERO key To increase the temperature by one degree. (0-99°C)
- MODE key To decrease the temperature by one degree. (0-99°C)
- PRINT key To store the change, display End and return to the density mode (the condition of step1, (2) Selecting a parameter to set).
- CAL key To cancel the change and return to the density mode (the condition of step 1, (2) Selecting a parameter to set).

The relation between the water temperature and density is shown below.

Temp. (°C)	+0	+1	+2	+3	+4	+5	+6	+7	+8	+9
0	0.99984	0.99990	0.99994	0.99996	0.99997	0.99996	0.99994	0.99990	0.99985	0.99978
10	0.99970	0.99961	0.99949	0.99938	0.99924	0.99910	0.99894	0.99877	0.99860	0.99841
20	0.99820	0.99799	0.99777	0.99754	0.99730	0.99704	0.99678	0.99651	0.99623	0.99594
30	0.99565	0.99534	0.99503	0.99470	0.99437	0.99403	0.99368	0.99333	0.99297	0.99259
40	0.99222	0.99183	0.99144	0.99104	0.99063	0.99021	0.98979	0.98936	0.98893	0.98849
50	0.98804	0.98758	0.98712	0.98665	0.98618	0.98570	0.98521	0.98471	0.98422	0.98371
60	0.98320	0.98268	0.98216	0.98163	0.98110	0.98055	0.98001	0.97946	0.97890	0.97834
70	0.97777	0.97720	0.97662	0.97603	0.97544	0.97485	0.97425	0.97364	0.97303	0.97242
80	0.97180	0.97117	0.97054	0.96991	0.96927	0.96862	0.96797	0.96731	0.96665	0.96600
90	0.96532	0.96465	0.96397	0.96328	0.96259	0.96190	0.96120	0.96050	0.95979	0.95906

- Enter the density directly ($Ld_{in} \text{ } \bar{d}$)

The density currently set (unit : g / cm³, factory setting : 1.0000g / cm³) is displayed.



Use the following keys to change the value.

- RE-ZERO key To set the value of the digit selected.
- SAMPLE key To select the digit to change the value.
- PRINT key To store the change, display End and return to the density mode (the condition of step1, (2) Selecting a parameter to set).
- CAL key To cancel the change and return to the density mode (the condition of step1, (2) Selecting a parameter to set).

Note

The range to set the density is 0.0000 to 1.9999 g / cm³

(4) Outputting the density.

After all the necessary parameters have been set, press the SAMPLE key to output the density calculated.

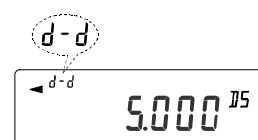

Calculated results

Note

The density is displayed with three decimal places.

14. I/O UNIT SPECIFICATIONS (Standard)

14-1 RS-232C//External Contact Input)

D-Sub 25 pin numbers

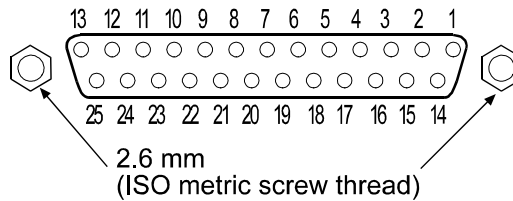

D-Sub 25 pin assignments

Pin No.	Signal name	Interface type	Direction	Description
1	FG		-	Frame ground
2	RXD	RS-232C	Input	Receive data
3	TXD	RS-232C	Output	Transmit data
4	RTS	RS-232C	Input	Ready to send
5	CTS	RS-232C	Output	Clear to send
6	DSR	RS-232C	Output	Data set ready
7	SG	RS-232C/external contact input	-	Signal ground
18	PRINT	External contact input	Input	Same as the PRINT key
19	RE-ZERO	External contact input	Input	Same as the RE-ZERO key
Others	-	-	-	No connection

RS-232C

The balance is a DCE device. Connect the balance to a personal computer (DTE), using a straight through cable.

- Transmission system : EIA RS-232C
- Transmission form : Asynchronous, bi-directional, half duplex
- Transmission rate : 10 times/second or 5 times/second (same as data refresh rate)
- Data format :
 - Baud rate : 600, 1200, 2400, 4800, 9600, 19200bps
 - Data bits : 7 or 8 bits
 - Parity : Even, Odd (Data bits 7 bits)
None (Data bits 8 bits)
 - Stop bit : 1 bit
(When sending, 2 bits; receiving, 1 bit.
A personal computer will function with either setting.)
 - Code : ASCII

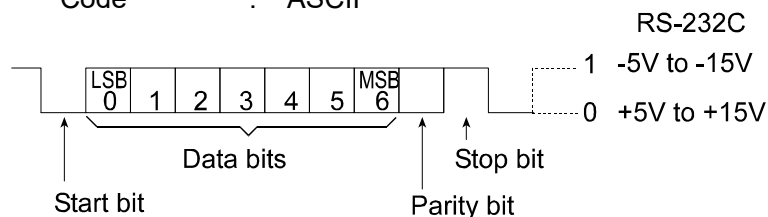

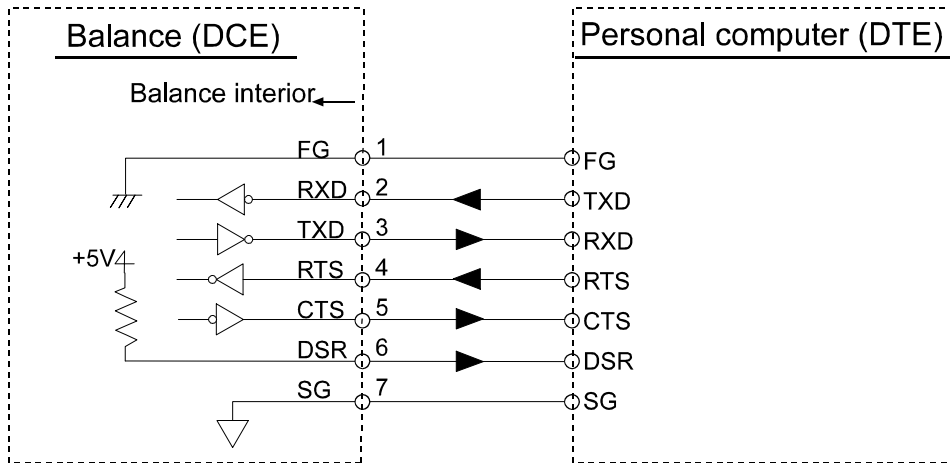

External contact input

By connecting pin 18 to pin 7, or pin 19 to pin 7, for more than 100 ms, the same operation as performed by pressing the **RE-ZERO** key or the **PRINT** key, will be performed.

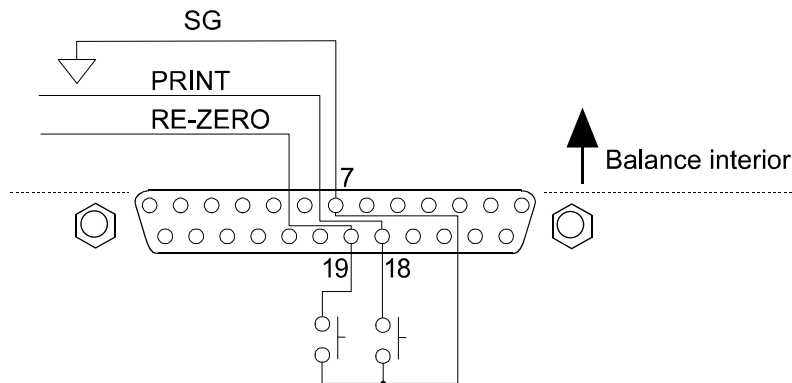

Use of example

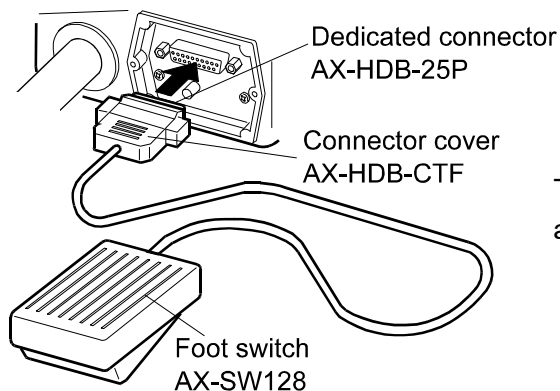

The external input connector (AX-HDB-25P/CTF) and the foot switch (AX-SW128) are sold separately.

15. CONNECTION TO PERIPHERAL EQUIPMENT

15-1 Connection to the AD-8127 Multi Printer

When connecting the printer to the balance for printing measured values, configure the printer and the balance as follows according to these usage examples.

Internal settings of the printer

Usage example	AD-8127 Multi printer Printing mode settings
When printing values measured by the balance with the balance's PRINT key or its "Auto-print" mode.	EXT.KEY
When printing values measured by the balance with the printer's "Printing" key or while in its timer mode. When printing charts with the printer.	MANUAL AUTO TIMER CHART
When printing the balance's statistical calculation results. When printing the balance's GLP data output.	DUMP

- Refer to the instruction manual of the AD-8127 for how to change internal settings of the AD-8127 multi printer.

Internal settings of the balance

Usage example	Balance <i>Prt</i> Data output mode	Balance <i>TYPE</i> Data format
When printing values measured by the balance with the balance's PRINT key or its "Auto-print" mode.	0, 1, 2, 4, 5	0
When printing values measured by the balance with the printer's "Printing" key or while in its timer mode. When printing charts with the printer.	3, 6	0
When printing the balance's statistical calculation results. When printing the balance's GLP data output.	0, 1, 2, 4, 5, 6	1

15-2 Connection to a Computer

The GP series balance is of the DCE type (Data Communication Equipment), which can be connected to a personal computer using the RS-232C interface.

Before connection, read the personal computer manual thoroughly.

Use a standard DCE cable for connection (cable type: straight-through).

When the personal computer type is a DOS/V with a 9-pin port, use a straight-through cable with a 25-pin male connector and a 9-pin female connector.

15-3 Using Windows Communication Tools (WinCT)

When Windows is used as an operating system in a personal computer, the WinCT software can be used to transmit the weighing data to the personal computer.

The WinCT software has two communication methods: "RsCom", "RsKey" and "RsWeight". For details on WinCT, refer to the WinCT instruction manual.

RsCom

- Can transmit commands to control the balance.
- Can make bi-directional communication between the balance and a personal computer using the RS-232C interface.
- Can display or store the data using a text file format. Can also print the data using a printer connected to the personal computer.
- When several ports of a personal computer have balances connected, can communicate with each balance simultaneously.
- Can share a personal computer with other application software.
- Can receive the balance GLP report.

RsKey

- Can transmit the weighing data output from the balance directly to other application software such as Microsoft Excel.
- Can be used with most application software.
- Can receive the balance GLP report.

RsWeight

- The weighing data transmitted from the balance can be displayed in graph form on the monitor in real-time.
- The axis scale of a graph automatically alters according to the data. It can be also changed manually.
- The graph can be printed out using a printer.
- The recorded data can be saved in CSV format.
- Maximum, minimum, average, standard deviation and coefficient of variation values can be calculated and displayed on the monitor.

Note

Windows and Excel are registered trademarks of Microsoft Corporation.

15-4 Using the WinCT software, the balance can do the following:

- 1 Analyzing the weighing data and the statistics with “RsKey”
The weighing data can be input directly into an Excel worksheet. Then, Excel can analyze the data to obtain total, average, standard deviation, maximum and minimum value, and display them in a graph.
- 2 Controlling the balance using commands from a personal computer
By using “RsCom”, the personal computer sends commands such as “re-zero” or “send weighing data” to the balance and controls the balance.
- 3 Printing the balance GLP report using your printer
The balance GLP report can be printed using a printer connected to the personal computer.
- 4 Receiving weighing data at a certain interval
The weighing data can be received at a certain interval and data characteristic with elapsed time can be obtained.
- 5 Using the GP series balance memory function
The data can be stored in the balance’s memory. Of the data stored, the weighing data and calibration data can be transmitted to a personal computer at one time.
- 6 Using a personal computer as an external indicator
With the “RsKey” test mode function, a personal computer can be used as an external weight indicator for the balance. (To do this, set the balance data output mode to stream mode.)

16. COMMANDS

16-1 Command List

Note

A command has a terminator added, that is specified using “S rLF” of the function table, and is sent to the balance.

Commands to query weighing data	
C	Cancels the S or SIR command.
Q	Requests the weighing data immediately.
S	Requests the weighing data when stabilized.
SI	Requests the weighing data immediately.
SIR	Requests the weighing data continuously.
Commands to control the balance	
CAL	Same as the CAL key.
OFF	Turns the display off.
ON	Turns the display on.
P	Same as the ON:OFF key
PRT	Same as the PRINT key
R	Same as the RE-ZERO key
SMP	Same as the SAMPLE key.
U	Same as the MODE key
UN:mm	Recalls the unit mass values in memory. (mm indicates 01-50)
?UN	Requests the unit mass numbers in memory.
UW:*****. * ㄱ ㄱ g	Changes the unit mass value. (Only “g” is available as a unit.) Command e.g.: UW:+002000.0 ㄱ ㄱ g (Set the unit mass value to 2000.0 g: ㄱ indicates a space.)
?UW	Requests the unit mass value.
CN:mm	Recalls the upper/lower limit value in memory (mm indicates 01-20)
?CN	Requests the upper/lower limit value code number of the selected value.
HI:*****. * ㄱ ㄱ g	Sets the upper limit values. Command e.g.: HI:+002000.0 ㄱ ㄱ g (To set the upper limit value to 2000.0 g: ㄱ indicates a space.)
LO:*****. * ㄱ ㄱ g	Sets the lower limit values. Command e.g.: LO:+001000.0 ㄱ ㄱ g (To set the lower limit value to 1000.0 g: ㄱ indicates a space.)
?HI	Requests the upper limit value.
?LO	Requests the lower limit value.
PN:mm	Recalls the tare value in memory. (mm indicates 01-20)
?PN	Request the tare number of the selected value. (mm indicates 01-20)
PT:*****. * ㄱ ㄱ g	Sets the tare value. Command e.g.: PT:+001000.0 ㄱ ㄱ g (To set the tare value to 1000.0 g: ㄱ indicates a space.)
?PT	Request the tare value.
MCL	Deletes all data in memory.
MD:nnn	Deletes data with the data number nnn.
?MA	Outputs all weighing data in memory.
?MQnnn	Outputs data with the data number nnn.
?MX	Outputs the number of data in memory (the last data number)

Notes

When a unit is required in commands such as a “PT:” command, use the 3-digit unit code of the A&D standard format.

nnn indicates a three-digit numerical value.

16-2 Acknowledge Code and Error Codes

When the “Serial interface function (*S iF*)” parameter is set to “*ErrCd 1*”, the balance outputs <AK> code or error code to each command as follows:

<AK> (06h) Acknowledge in ASCII code.

- When the balance receives a command to request data and can not process it, the balance transmits an error code (EC, Exx).

When the balance receives a command to request data and can process it, the balance outputs the data.

- When the balance receives a command to control the balance and can not process it, the balance transmits an error code (EC, Exx).

When the balance receives a command to control the balance and can process it, the balance transmits the acknowledge code.

Among commands to control the balance, the following transmit the acknowledge code both when the balance receives the command and when the balance has accomplished the command. If the command can not be processed properly, the balance transmits an error code (EC, Exx). This error can be released using the CAL command.

CAL command (Calibration command) ON command (Display ON command)

P command (Display ON/OFF command) R command (RE-ZERO command)

- When a communication error has occurred due to external noise, or a parity error has occurred due to transmission error, the balance transmits an error code. In this case, send the command again.

16-3 Control Using CTS and RTS

Depending on the “*CTS*” parameter of “Serial interface (*S iF*)”, the balance performs as follows:

CTS 0

Regardless of whether the balance can receive a command or not, the balance keeps the CTS line Hi. The balance outputs data regardless of the condition of the RTS line.

CTS 1

The CTS line is kept Hi normally. When the balance can not receive the next command (e.g. while the balance is processing last command), the balance sets the CTS line to Lo. The balance confirms the level of the RTS line before outputting a set of data. If the RTS level is Hi, the balance outputs data. If the RTS level is Lo, data is not output (The data is canceled).

16-4 Settings Related to RS-232C

Concerning the RS-232C, the balance has two functions: “Data output (*dout*)” and “Serial interface (*S iF*)”. Set each function as necessary.

17. MAINTENANCE

- Do not disassemble the balance. Contact the local A&D dealer if the balance needs service or repair.
- Use the original packing material for transportation.
- Do not use organic solvents to clean the balance. Clean the balance with a lint free cloth that is moistened with warm water and a mild detergent.
- The mass of the internal mass may change due to corrosion or other damage caused by the operating environment, or due to aging. Check the internal mass using an external weight periodically.

18. TROUBLESHOOTING

18-1 Checking the Balance Performance and Environment

The balance is a precision instrument. When the operating environment or the operating method is inadequate, correct weighing can not be performed. Place a sample on the pan and remove it, and repeat this several times. If the balance seems to have a problem with repeatability or to perform improperly, check as described below. If improper performance persists after checking, contact the local A&D dealer for repair.

Checking that the balance performs properly

- Check the balance performance using the self-check function as described in “6-1 Automatic Response Adjustment / Self Check Function”.
An error display appears when a malfunction is found.
- Check the balance repeatability using an external weight. Be sure to place the weight in the center of the weighing pan.
- Check the balance repeatability, linearity and calibrated value using external weights with a known value.

Checking that the operating environment or weighing method is proper

Operating environment

- Is the weighing table solid enough?
- Is the balance level? Refer to “3-1 Before Use”.
- Is the operating environment free from vibration and drafts?
- Is there a strong electrical or magnetic noise source such as a motor near the balance?



Weighing method

- Is the weighing pan installed correctly?
- Is the **RE-ZERO** key pressed before placing a sample on the weighing pan?
- Is the sample placed in the center of the weighing pan?
- Has the balance been calibrated using the internal mass (one-touch calibration)?
- Has the balance been warmed up for 30 minutes before weighing?

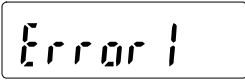

Sample and container

- Has the sample absorbed or lost moisture due to the ambient conditions such as temperature and humidity?
- Has the temperature of the container been allowed to equalize to the ambient temperature? Refer to “3-2 During Use”.
- Is the sample charged with static electricity? Refer to “3-2 During Use”.
- Is the sample of magnetic material such as iron? Caution is required for weighing magnetic materials. Refer to “3-2 During Use”.

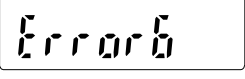
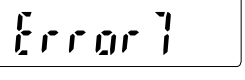
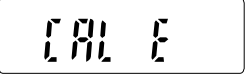
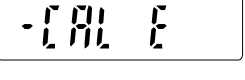
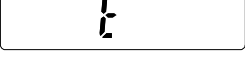
18-2 Error Codes

Display	Error code	Description
	EC, E11	<p>Stability error</p> <p>The balance can not stabilize due to an environmental problem. Prevent vibration, drafts, temperature changes, static electricity and magnetic fields, from influencing the balance.</p> <p>Refer to “3. PRECAUTIONS” for details on the operating environment and “6. RESPONSE ADJUSTMENT/SELF CHECK FUNCTION” about adapting the balance to the environment.</p> <p>To return to the weighing mode, press the CAL key.</p>
		<p>Out of the setting range</p> <p>The data to be stored is out of the setting range.</p>
	EC, E16	<p>Internal mass error</p> <p>Applying the internal mass does not yield a change in the weight value as specified.</p> <p>Confirm that there is nothing on the pan and perform the weighing operation from the beginning again.</p>
	EC, E17	<p>Internal mass error</p> <p>The internal mass application mechanism does not function properly.</p> <p>Perform the weighing operation from the beginning again.</p>
	EC, E20	<p>Calibration weight error</p> <p>The calibration weight is too heavy. Confirm the calibration weight value.</p> <p>Press the CAL key to return to the weighing mode.</p>
	EC, E21	<p>Calibration weight error</p> <p>The calibration weight is too light. Confirm the calibration weight value.</p> <p>Press the CAL key to return to the weighing mode.</p>
		<p>Overload error</p> <p>A sample beyond the balance weighing capacity has been placed on the pan.</p> <p>Remove the sample from the pan.</p>

Display	Error code	Description
		Weighing pan Error The weight value is too light. Confirm that the weighing pan is properly installed and calibrate the balance.
		Sample mass error The balance can not store the sample for the counting mode or for the percent mode because it is too light. Use a larger sample.
 		Unit mass error The sample unit mass for the counting mode is too light. Storing and using it for counting will cause a counting error. Add samples to reach the specified number and press the PRINT key. Pressing the PRINT key without adding samples will shift the balance to the counting mode. But, to acquire accurate weighing, be sure to add samples.
		Automatic response adjustment zero error The automatic response adjustment can not be performed because there is something on the pan. Clear the pan. Press the CAL key to return to the weighing mode.
 (CHECK NG)		Automatic response adjustment unstable error The automatic response adjustment can not be performed because the weight value is unstable. Check the ambient conditions such as breeze, vibration and magnetic fields, also check the weighing pan. Press the CAL key to return to the weighing mode.
 (CHECK NO)		Internal error Indicates an internal error as the result of self-check function. Repair is required. Contact the local A&D dealer.
		Clock battery error The clock backup battery has been depleted. Press any key and set the time and date. The clock and calendar function works normally as long as the AC adapter is connected to the balance. If this error appears frequently, contact the local A&D dealer.
		Low battery error Voltage of the power supply drops. Confirm whether the correct AC adapter is used.
	(Blinking)	Memory full The amount of weighing data in memory has reached the maximum capacity. Delete data in memory to store new data. For details, refer to "11. DATA MEMORY".
	(Illuminated)	Memory full The amount of calibration or calibration test data in memory has reached the maximum capacity (50 sets). The data in memory will be deleted automatically to store new data. For details, refer to "11. DATA MEMORY".

Display	Error code	Description
		Memory type error Type of memory set in the function table and type of data stored are different. For details, refer to "11. DATA MEMORY".
	EC, E00	Communications error A protocol error occurred in communications. Confirm the format, baud rate and parity.
	EC, E01	Undefined command error An undefined command was received. Confirm the command.
	EC, E02	Not ready A received command can not be processed. e.g. The balance received a Q command, but not in the weighing mode. e.g. The balance received a Q command while processing a RE-ZERO command. Adjust the delay time to transmit a command.
	EC, E03	Timeout error If the timeout parameter is set to "L-UP 1", the balance did not receive the next character of a command within the time limit of one second. Confirm the communication.
	EC, E04	Excess characters error The balance received excessive characters in a command. Confirm the command.
	EC, E06	Format error A command includes incorrect data. e.g. The data is numerically incorrect. Confirm the command.
	EC, E07	Parameter setting error The received data exceeds the range that the balance can accept. Confirm the parameter range of the command.
Other errors		If the errors described above can not be released or other errors are displayed, contact the local A&D dealer.
Other symbol		
		When this indicator blinks, automatic self calibration is required. The indicator blinks when the balance detects changes in ambient temperature. If the balance is not used for several minutes with this indicator blinking, the balance performs automatic self calibration. The blinking period depends on the operating environment.

18-3 Asking For Repair

If the balance needs service or repair, contact the local A&D dealer.

The balance is a precision instrument. Use much care when handling the balance and observe the following when transporting the balance.

- Use the original packing material.
- Remove the weighing pan from the main unit.

19. SPECIFICATIONS

		GP-12K	GP-20K	GP-30K GP-30KS	GP-32K GP-32KS	GP-40K
Weighing capacity		12 kg	21 kg	31 kg	31 kg	41 kg
Maximum display (See bottom for the description of *)		12.0084 kg	21.0084 kg	31.0084 kg	31.008 kg 6.1009 kg*	41.0080 kg
Minimum weighing value (1 digit)		0.1 g			1 g/0.1 g	0.5 g
Repeatability (Standard deviation)		0.1 g			0.5 g/0.1 g	0.5 g
Linearity		±0.2 g			±1g/±0.2 g	±1g
Stabilization time (typical at FAST)		Approx. 1.5 seconds				
Sensitivity drift (10°C-30°C/50°F-86°F) **		±3 ppm/°C			±5 ppm/°C	
Accuracy right after calibration using the internal mass. ***		±1.0 g		±1.5 g		
		The value above is to the weighing capacity.				
Operating environment		5°C to 40°C (41°F to 104°F) 85%RH or less (No condensation)				
Display refresh rate		5 times/second or 10 times/second				
Counting mode	Minimum unit mass	0.1 g			1 g	0.5 g
	Number of samples	10, 25, 50 or 100 pieces				
Percent mode	Minimum 100% reference mass	10 g			100 g	50 g
	Minimum 100% display	0.01%, 0.1%, 1% (Depends on the reference mass stored.)				
Interface		RS-232C				
External calibration weight		5 kg	10 kg	20 kg		20 kg
		10 kg	20 kg	30 kg		30 kg
						40 kg
Weighing pan		384 x 344 mm				
Dust and water protection		Complying with IP65				
Sensor used		Super Hybrid Sensor (SHS)				
AC adapter		Confirm that the adapter type is correct for the local voltage and power receptacle type				
Power consumption		Approx. 30VA (supplied to the AC adapter)				
External dimensions (WxDxH, mm)		372 x 615 x 130 (GP-30KS/ GP-32KS: 344 x 442 x 130) ****				
Net weight		Approx. 17 kg				

* The GP-32K and GP-32KS allow weighing using a precision range, even with a heavy tare placed on the pan. (Smart range function)

** When automatic self calibration is not used, at 10°C to 30°C (50°F to 86°F)

*** Accuracy right after calibration using the internal mass in good ambient conditions (within the temperature range of 10°C to 30°C (50°F to 86°F) with no abrupt changes in temperature or humidity, no drafts, no effect by magnetic fields or static electricity).
Check the internal mass periodically as described in "17. MAINTENANCE".

**** The size for the GP-30KS/32KS is that of the main unit. The display size is 260x164x202.
The cable length, for the separate display type balances (GP-30KS/32KS), is 3 meters.

	GP-60K GP-60KS	GP-61K GP-61KS	GP-100K GP-100KS	GP-102K	
Weighing capacity	61 kg	61 kg	101 kg	101 kg	
Maximum display (See bottom for *)	61.084 kg	61.0084 kg	101.084 kg	101.08kg 61.009 kg*	
Minimum weighing value (1 digit)	1 g	0.1 g	1 g	10 g/1 g	
Repeatability (Standard deviation)	0.7 g	0.2 g	1 g	5 g/1 g	
Linearity	±1 g	±0.5 g	±2 g	±10 g/±2 g	
Stabilization time (typical at FAST)	Approx.1.5 seconds				
Sensitivity drift (10°C-30°C/50°F-86°F) **	±6ppm/°C			±10 ppm/°C	
Accuracy right after calibration using the internal mass. ***	±5 g	±3 g	±10 g		
	The value above is to the weighing capacity.				
Operating environment	5°C to 40°C (41°F to 104°F) 85%RH or less (No condensation)				
Display refresh rate	5 times/second or 10 times/second				
Counting mode	Minimum unit mass	1 g	0.1 g	1 g	10 g
	Number of samples	10, 25, 50 or 100 pieces			
Percent mode	Minimum 100% reference mass	100 g	10 g	100 g	1000 g
	Minimum 100% display	0.01%, 0.1%, 1% (Depends on the reference mass stored.)			
Interface	RS-232C				
External calibration weight	30 kg 40 kg 50 kg 60 kg		60 kg 80 kg 100 kg		
Weighing pan	384 x 344 mm		386 x 346mm		
Dust and water protection	Complying with IP65				
Sensor used	Super Hybrid Sensor (SHS)				
AC adapter	Confirm that the adapter type is correct for the local voltage and power receptacle type				
Power consumption	Approx. 30VA (supplied to the AC adapter)				
External dimensions (WxDxH, mm)	372 x 615 x 130 (GP-60KS/ GP-61KS: 344 x 442 x 130) ****		373 x 615 x 130 (GP-100KS: 346 x 443 x 130) ****		
Net weight	Approx. 17 kg		Approx. 18 kg		

* The GP-102K allow weighing using a precision range, even with a heavy tare placed on the pan. (Smart range function)

** When automatic self calibration is not used, at 10°C to 30°C (50°F to 86°F)

*** Accuracy right after calibration using the internal mass in good ambient conditions (within the temperature range of 10°C to 30°C (50°F to 86°F) with no abrupt changes in temperature or humidity, no drafts, no effect by magnetic fields or static electricity).

Check the internal mass periodically as described in "17. MAINTENANCE".

**** The size for the GP-60KS/61KS/100KS is that of the main unit. The display size is 260x164x202. The cable length, for the separate display type balances (GP-60KS/61KS /100KS), is 3 meters.

20. EXTERNAL DIMENSIONS

Standard Type: GP-12K/20K/30K/32K/40K/60K/61K/100K/102K

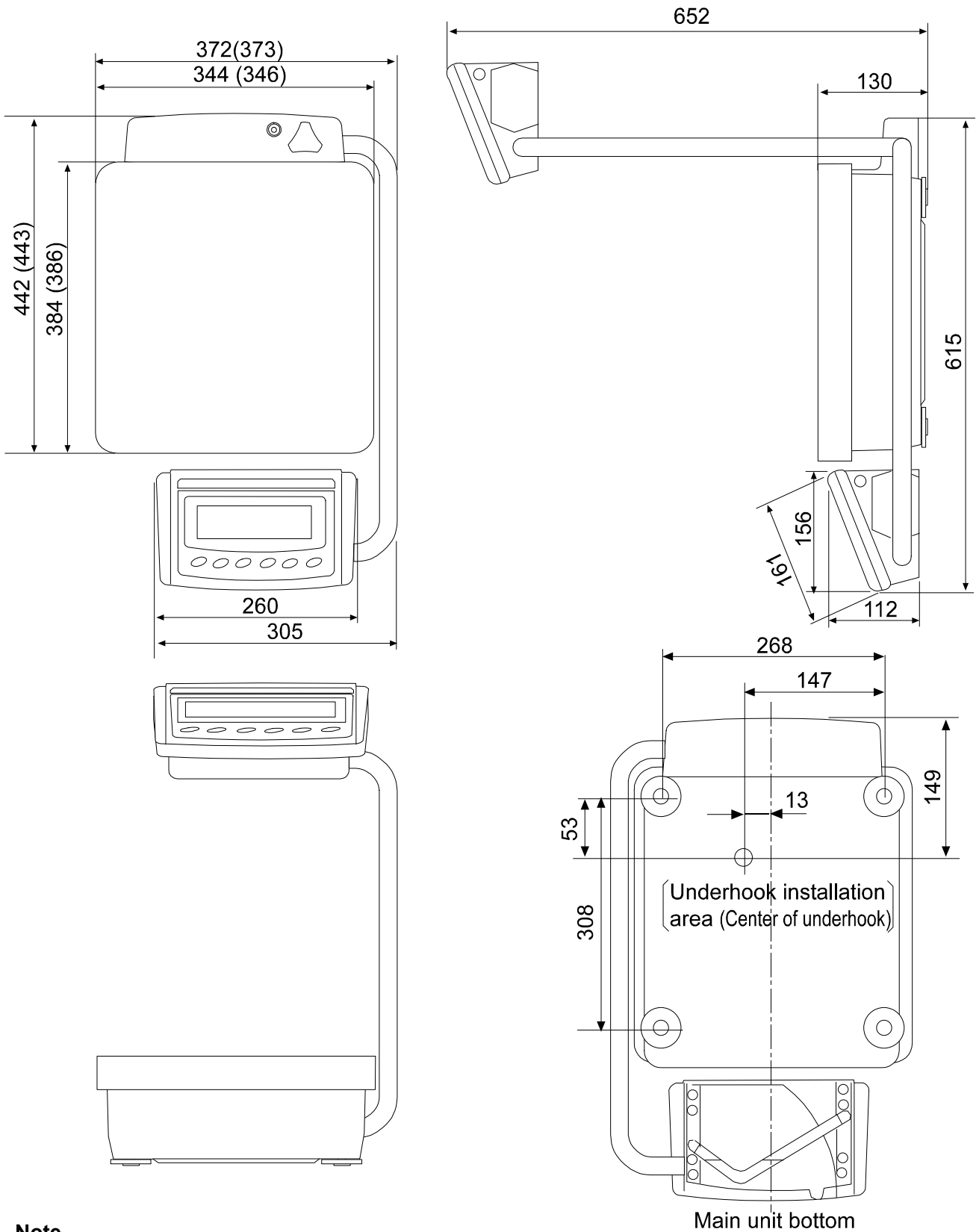

Note

The size in parentheses is for the GP-100K/102K

Unit: mm

Separate Display Type: GP-30KS/32KS/60KS/61KS/100KS

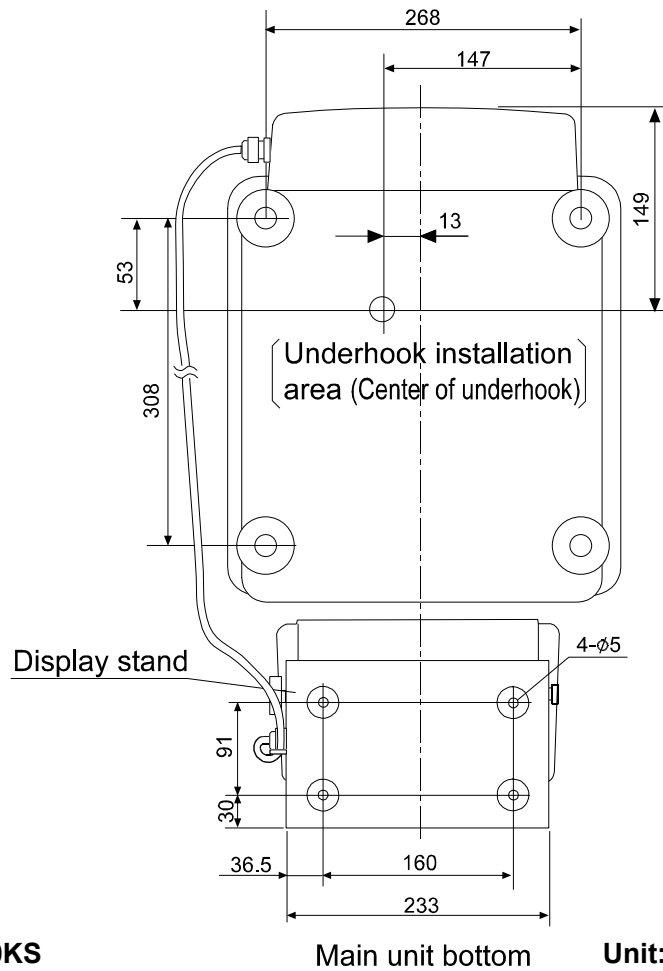
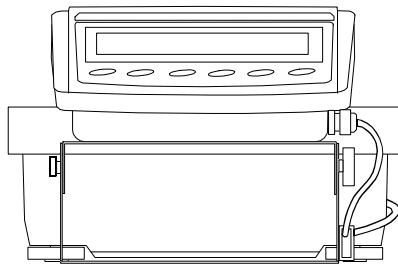
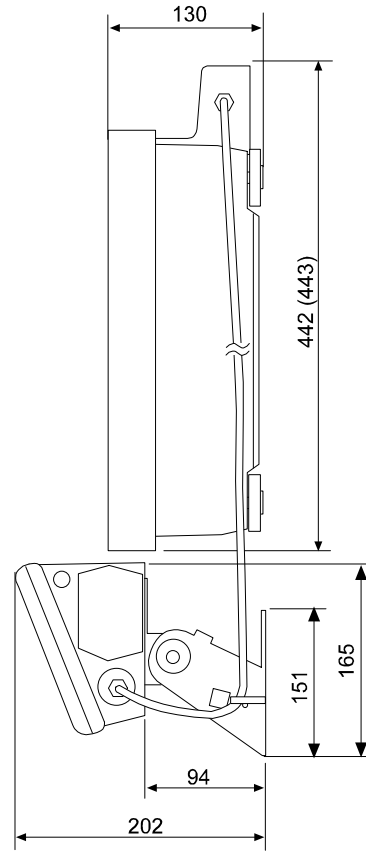
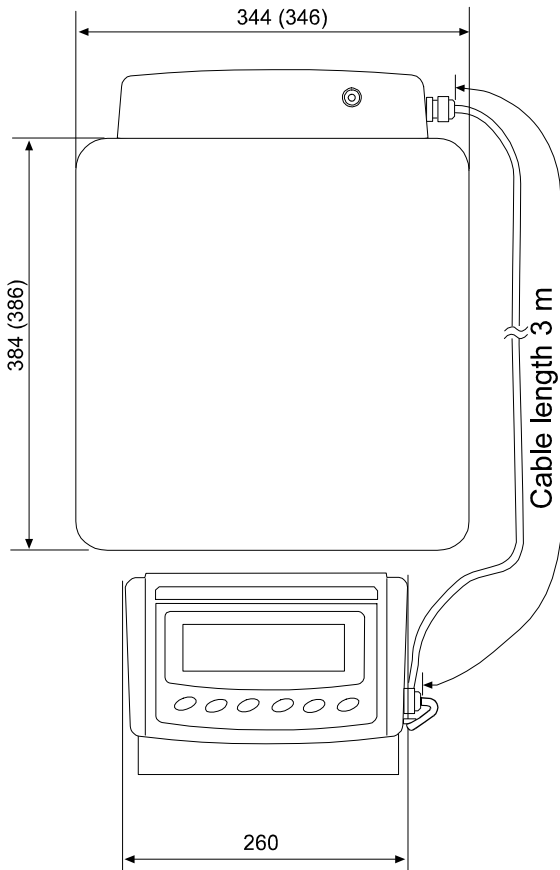

Note

The size in parentheses is for GP-100KS

21. OPTIONS

OP-04: Comparator output (relay/ with a buzzer)/RS-232C/Current loop

- Generates a relay output corresponding to **HI**, **OK** and **LO** in the display.
- Current loop and RS-232C can be used at the same time. For example, a personal computer and an AD-8121B printer can be used simultaneously.
- Installed in place of the standard RS-232C serial interface.

OP-06: Analog voltage output/Current loop

- Gains a voltage of 0-1V (or 0.2-1V) depending on the displayed value.
- With this option, current loop can be used. For example, an AD-8121B printer can be used simultaneously using this option.
- Installed in place of the standard RS-232C serial interface. So, RS-232C is not available for use.

OP-07: Extension cable, 5 m (Available as factory option only when ordered with a GP balance)

- Applicable balance models: GP-30KS/32KS/60KS/61KS/100KS
- A cable of 5 meters, to connect between the display and the main unit

OP-20: Underhook

- Applicable balance models: GP-12K/20K/30K/30KS/32K/32KS/40K
- Used for measuring the density of magnetic materials and concrete (coarse aggregates).

OP-21: Underhook

- Applicable balance models: GP-60K/60KS/61K/61KS/100K/100KS/102K
- Used for measuring the density of magnetic materials and concrete (coarse aggregates).

OP-22: Printer bracket

- Used to place the AD-8121B printer beside the display.

AD-8127 Multi Printer

- Compact dot-matrix printer
- Statistical function, clock and calendar function, interval print function, graphic print function, dump print mode
- 7 x 9 dots, 24 characters per line
- Print paper (AX-PP137-S, 57.5 (W) x 30 (L) mm , ø65 mm)
- AC adapter

AD-1682: Rechargeable battery

- Allows use of the balance in a place where AC power is not available.

AD-1684: Electrostatic field meter

- This option measures the amount of the static charge on the sample, tare or peripheral equipment and displays the result.
If those are found to be charged, discharge them using the AD-1683 DC static eliminator.

AD-1687: Weighing environment logger

- A data logger equipped with 4 sensors for temperature, humidity, barometric pressure and vibration that can measure and store environmental data. When connected to the RS-232C interface of the balance, the AD-1687 can store environmental data along with weighing data. Therefore, it is possible to store data in an environment where a computer can not be used.
- The stored data can be read to a personal computer using USB. As the AD-1687 is recognized as USB memory, special software is not required to read the data.

AD-1688: Data logger

- When connected to the RS-232C interface of the balance, the AD-1688 can store the data in an environment where a personal computer can not be used.

AD-8524A/B: Keyboard adapter

- Used to connect the balance to a personal computer with appropriate OS and applications.

AD-8526: LAN converter

- This option can be used to connect the RS-232C interface of the balance to the Ethernet (LAN) port of a computer. This allows management of the balance weighing data with a computer connected to a network.

AD-8920A: Remote display

- Connected to the GP series using the RS-232C interface.

AD-8922A: Remote controller

- This option can be connected to the balance using the RS-232C interface and can control the balance remotely.
Various options such as comparator output or analog output are available.

AX-SW128: Foot switch

- Used to externally transmit a RE-ZERO or PRINT signal to the balance.

AX-USB-25P-EX: USB converter

- Adds a COM port to a PC.
- Enables bi-directional communication between the PC and the balance when a USB driver is installed.
- Can use serial communication software such as WinCT on a PC without COM ports.
- An RS-232C cable is provided to connect the USB converter to the balance.











22. TERMS/INDEX

Terms

Stable value	The stable weight data, indicated by the illuminated stabilization indicator.
Environment	Ambient conditions such as vibration, drafts, temperature, static electricity and magnetic fields which affect the weighing operation.
Store	To save the weighing data, unit mass or calibration data using the data memory function.
Calibration	Adjustment of the balance so that it can weigh accurately.
Output	To output the weighing data using the RS-232C interface.
Zero point	A weighing reference point. Usually refers to the value displayed when nothing is on the weighing pan.
Smart range function	Allows weighing in the precision range, even if a heavy tare is used.
Data number	Numbers assigned sequentially when weighing data or unit weight is stored.
Digit	The minimum weighing value available. Used for the balance, 1 digit is the smallest displayable mass.
Tare	To cancel the weight of a container which is not to be included in the weighing data. Normally, refers to an operation of placing a container and setting the display to zero.
Mode	Balance operational function.
Re-zero	To set the display to zero.
GLP	Good Laboratory Practice.
Repeatability	Variation in measured values obtained when the same mass is placed and removed repetitively. Usually expressed as a standard deviation. e.g. Standard deviation=1 digit: This means that measured values, obtained when the same sample is placed and removed repetitively, fall within ± 1 digit in the frequency of about 68%.
Stabilization time	Time required after a sample being placed, until the stabilization indicator illuminates and the weighing data is displayed.
Sensitivity drift	An affect that a change in temperature causes to the weighing data. Expressed as temperature coefficient. e.g. Temperature coefficient = 3 ppm/ $^{\circ}\text{C}$: If a load is 20 kg and the temperature changes by 10°C , the value displayed changes by the following value. $0.0003\%/^{\circ}\text{C} \times 10^{\circ}\text{C} \times 20 \text{ kg} = 0.6 \text{ g}$ In this example, if the value displayed is 20.0000 kg before temperature changes, a temperature change of 10°C will make the value displayed 20.0006 kg.

Index

Key and symbols

	ON:OFF key	11
	SAMPLE key	11
	MODE key	11
	CAL key	11
	PRINT key	11
	RE-ZERO key	11
	Stabilization indicator	11
	Interval memory active indicator	11
	Interval memory standby indicator	11
	Prior notice indicator of automatic self calibration	11
	Processing indicator	11
?CN		82
?HI		82
?LO		82
?MA		82
?MQnnn		82
?MX		82
?PN		82
?PT		82
?UN		82
?UW		82

- A -

A&D standard format	43
AC adapter	7, 8, 88, 89
AC adapter ID label	7, 8
ACAI	19
Accumulation function	21, 41
AD-1682	92
AD-1684	92
AD-1687	93
AD-1688	93
AD-8127	79, 92
AD-8524A/B	93
AD-8526	93
AD-8920A	93
AD-8922A	93
<i>Rdd</i>	21, 37, 41
AK	83
Angle adjusting knob	7, 8
Animal mode indicator	11, 40
<i>RP-b</i>	37
<i>RP-P</i>	37
<i>RR-d</i>	39
<i>RL-F</i>	39
Auto display-OFF	41
Auto display-ON	41
Auto print mode A	42
Auto print mode B	42
Automatic response adjustment	23
Automatic self calibration	26
AX-SW128	78, 93
AX-USB-25P-EX	93

- B -

<i>bRSFnc</i>	37
<i>bEP-</i>	37
<i>bEP-</i>	37
<i>bEP-</i>	37
<i>bPS</i>	39
<i>bEPr</i>	39
Bubble sprit level	7, 8

- C -

<i>CS in</i>	39
Cable clamp	7, 8

<i>CAL E</i>	85
<i>-CAL E</i>	85
CAL key	11
Calibration	25 - 29, 94
Calibration test	30, 31
Calibration weight error	85
Capacity indicator	11, 41
<i>CL Rdd</i>	37
Clear display cover	7, 8
Comparator function	50
Comparator indicators	11
<i>Cond</i>	37, 40
Condition	40
<i>CP</i>	37
<i>CP Fnc</i>	37
<i>CP H₁</i>	37
<i>CP in</i>	37
<i>CP Lnt</i>	37
<i>CP rEF</i>	37
<i>CP-b</i>	37
<i>CP-Lo</i>	37
<i>CP-r</i>	37
<i>crLF</i>	39
CSV format	44
<i>CS</i>	39

- D -

<i>dS Fnc</i>	39
<i>dRtA</i>	37
Data logger	93
Data memory	58
Data number	45, 94
Decimal point	41
Digit	94
Display at start	41
Display refresh rate	41, 88, 89
<i>d-no</i>	37
<i>dout</i>	39
<i>dout</i>	37
DP format	43
Dust and water protection	88, 89

- E -

<i>E</i>	86
<i>-E</i>	85
EC, E00	87
EC, E01	87
EC, E02	87
EC, E03	87
EC, E04	87
EC, E06	87
EC, E07	87
EC, E11	85
EC, E16	85
EC, E17	85
EC, E20	85
EC, E21	85
Electrostatic field meter	92
<i>ErCd</i>	39
<i>Error 1</i>	85
<i>Error 2</i>	85
<i>Error 6</i>	85
<i>Error 7</i>	85
External calibration weight	88, 89
External contact input	77, 78
External dimensions	88, 89

- F -

FAST	23
------	----

Foot switch	93
- G -	
GLP	37, 41
GLP	54, 94
Grounding terminal	7, 8
- H -	
Hold	37, 40
Hold function	40
- I -	
ID	39
ID number	45, 54
Info	39
Inhibit	34
Initializing the balance	35
Int	37
Internal mass error	85
Interval memory active indicator	11
Interval memory mode	43
Interval memory standby indicator	11
IP65	88, 89
- K -	
Key mode	42
Keyboard adapter	93
KF format	44
- L -	
LAN converter	93
Lid	39
Leveling foot	7, 8
Linearity	88, 89
Lo	86
- M -	
Maximum display	88, 89
Memory full	86
MID	23
Minimum weighing value	88, 89
Net	39
Mode	94
MODE key	11
MT format	44
- N -	
NET indicator	11
Net weight	88, 89
NU format	44
- O -	
100% reference mass	20
ON:OFF key	11
OP-04	92
OP-06	92
OP-07	92
OP-20	92
OP-21	92
OP-22	92
Operating environment	88, 89
Out of the setting range	85
Overload error	85
- P -	
Percent mode	20
Permit	34
Pnt	37, 41
PoFF	37, 41

P-on	37, 41
Power consumption	88, 89
PRINT key	11
Printer bracket	92
Prior notice indicator of automatic self calibration	11
Processing indicator	11
Prt	37
PUSE	39
- R -	
Rechargeable battery	92
Reference card	7, 8
Remote controller	93
Remote display	93
Repeatability	88, 89
RESPONSE	23
Response characteristic	23
Response indicator	11
RE-ZERO key	11
RnU	37, 41
RsCom	80
RsKey	80
- S -	
SAMPLE key	11
Sample mass error	86
Self check function	23
Sensitivity drift	88, 89
SHS	88, 89
Sid	37
SLOW	23
Smart range function	12, 94
SPd	37, 41
Stability band width	40
Stability error	85
Stabilization indicator	11
Stabilization time	88, 89
Stable value	23, 94
Standby indicator	11
St-b	37, 40
St-d	37
Stream mode	42
Swing arm	7, 8
- T -	
Tare	94
trc	37, 41
t-UP	39
tYPE	39
- U -	
Underhook	10, 92
Unit	39
Unit mass	18
Unit mass error	86
Units	13
USB converter	93
- W -	
Warm up	8, 9
Weighing capacity	88, 89
Weighing environment logger	93
Weighing pan	7, 8, 88, 89
Weighing pan error	86
WinCT	80
- Z -	
Zero point	94
Zero tracking	41



A&D Company, Limited

3-23-14 Higashi-Ikebukuro, Toshima-ku, Tokyo 170-0013, JAPAN
Telephone: [81] (3) 5391-6132 Fax: [81] (3) 5391-1566

A&D ENGINEERING, INC.

1756 Automation Parkway, San Jose, California 95131, U.S.A.
Telephone: [1] (408) 263-5333 Fax: [1] (408) 263-0119

A&D INSTRUMENTS LIMITED

Unit 24/26 Blacklands Way, Abingdon Business Park, Abingdon, Oxfordshire OX14 1DY United Kingdom
Telephone: [44] (1235) 550420 Fax: [44] (1235) 550485

A&D AUSTRALASIA PTY LTD

32 Dew Street, Thebarton, South Australia 5031, AUSTRALIA
Telephone: [61] (8) 8301-8100 Fax: [61] (8) 8352-7409

A&D KOREA Limited

한국에이.엔.디(주)
서울특별시 영등포구 국제금융로6길33 (여의도동) 맨하탄빌딩 817 우편 번호 07331
(817, Manhattan Bldg., 33. Gukjegeumyung-ro 6-gil, Yeongdeungpo-gu, Seoul, 07331 Korea)
전화: [82] (2) 780-4101 팩스: [82] (2) 782-4264

ООО A&D RUS

ООО "ЭЙ энд ДИ РУС"
121357, Российская Федерация, г.Москва, ул. Верейская, дом 17
(Business-Center "Vereyskaya Plaza-2" 121357, Russian Federation, Moscow, Vereyskaya Street 17)
тел.: [7] (495) 937-33-44 факс: [7] (495) 937-55-66

A&D INSTRUMENTS INDIA PRIVATE LIMITED

ऐ&डी इन्स्ट्रूमेन्ट्स इण्डिया प्रा० लिमिटेड
509, उद्योग विहार , फेस -5, गुडगांव - 122016, हरियाणा , भारत
(509, Udyog Vihar, Phase-V, Gurgaon - 122 016, Haryana, India)
फोन : 91-124-4715555 फैक्स : 91-124-4715599

GP SERIES OPTIONS

GP-04 (Comparator output/RS-232C/
Current loop output)

GP-06 (Analog output/Current loop output)

INSTRUCTION MANUAL

AND
A&D Company, Limited

© 2001 A&D Company Ltd. All rights reserved.

No part of this publication may be reproduced, transmitted, transcribed, or translated into any language in any form by any means without the written permission of A&D Company Ltd.

The contents of this manual and the specifications of the instrument covered by this manual are subject to change for improvement without notice.

CONTENTS

1. INTRODUCTION	2
1-1 Description of the Options	2
1-2 Accessories.....	3
2. FUNCTION TABLE	4
2-1 Structure and Sequence of the Function Table.....	4
2-2 Display and Keys	4
2-3 Details of the Function Table	5
3. COMPARATOR OUTPUT (GP-04)	8
3-1 Installing the GP-04 Option.....	8
3-2 Specifications.....	9
3-3 Using the Comparator Output.....	10
3-4 Setting the Upper and Lower Limit Values	11
3-5 Example of Use	14
4. SERIAL OUTPUT	15
4-1 RS-232C (GP-04) Specifications	15
4-2 Current Loop Output (GP-04/GP-06) Specifications	17
4-3 Connection to the AD-8121 Printer	18
4-4 Description of the Item "Data output mode".....	18
4-5 Description of the Item "Data format"	20
4-6 Description of the Data Format Added to the Weighing Data	22
4-7 Data Format Examples	23
4-8 Connection to a Computer.....	24
4-9 Using Windows Communication Tools (WinCT).....	25
4-10 Using the WinCT software, the balance can do the following:	25
4-11 Commands.....	26
4-12 Acknowledge Code and Error Codes	27
4-13 Control Using CTS and RTS.....	27
4-14 Settings Related to RS-232C.....	27
5. ANALOG OUTPUT (GP-06)	28
5-1 Installing the GP-06 Option.....	28
5-2 Analog Output (GP-06) Specifications	29
5-3 Analog Output (<i>R_{out}</i>).....	30
5-4 Switching Output Voltage.....	32
5-5 Output Voltage Fine Adjustment	32
5-6 Fixed Output Voltage	33

1. INTRODUCTION

This manual describes how the GP series options, GP-04 and GP-06 work, and how to get the most out of them in terms of performance.

Read this manual thoroughly before using either option and keep it at hand for future reference.

1-1 Description of the Options

The description of the options is as follows:

- GP-04: Comparator output with a buzzer / RS-232C / Current loop output
- GP-06: Analog output / Current loop output

Functions and panel view

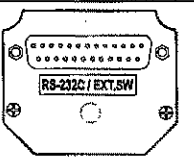
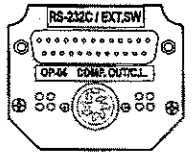
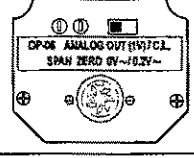
	Function				Panel view
	RS-232C	Current loop output	Comparator output	Analog output	
Standard • RS-232C	○	-	-	-	
GP-04 • Comparator output • RS-232C • Current loop output	○	○	○	-	
GP-06 • Analog output • Current loop output	-	○	-	○	

○:Available, -:Not available

Notes

Options GP-04 and GP-06 can not be used at the same time. The current loop interface is of the passive type, and an external power supply that provides 20 mA, is required. The external power supply is not necessary when connecting an AD-8121 printer with this current loop interface.

When option GP-04 or GP-06 is used, the display does not comply with IP65 (Dust-tight and Protected Against Water Jets). So, handle the scale with much care when either option is installed.

■ Comparator output

Contact-outputs, output the comparison results between the weighing data and upper/lower limit values, using **HI**, **OK**, and **LO**

Whether or not to sound a buzzer, depending on the results, can be selected.

■ **Analog output**

Two modes are available: To convert the specified weight value digits to voltage, and to convert the weight value, in the range from zero to the weighing capacity, to voltage.

Output voltage range selection: Using the slide switch located on the option panel, the output voltage range can be switched between 0-1 V and 0.2-1V. The default setting at shipment is 0-1V.

■ **RS-232C**

The RS-232C interface is used to communicate with a printer or a personal computer. Using the RS-232C interface, the following operations are available through a command from the computer:

- | | |
|----------------------------|---------------------------------|
| Outputs the weighing data. | Enters balance settings. |
| Controls the balance. | Retrieves the balance settings. |

■ **Current loop**

Current loop is a data output interface, mainly used as a printer interface.

■ **GLP output**

GLP-compliant data output is available for RS-232C and current loop. Refer to the balance instruction manual for details about GLP output.

1-2 Accessories

Each option is provided with the following accessories.

- GP-04: DIN connector (plug) 1 piece



Instruction manual (this document) 1 copy

- GP-06: DIN connector (plug) 1 piece



Screwdriver 1 piece

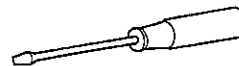

Instruction manual (this document) 1 copy

2. FUNCTION TABLE

The function table reads or rewrites the parameters that are stored in the balance. When GP-04 or GP-06 is used, set the function table to specify the balance performance. These parameters are maintained in non-volatile memory, even if the AC adapter is removed.

2-1 Structure and Sequence of the Function Table

The function table menu consists of two layers. The first layer is the "Class" and the second layer is the "Item". Each item stores a parameter.

Example

This example sets "Stores weighing data" for "Data memory" and "1 minute" for "Interval time".

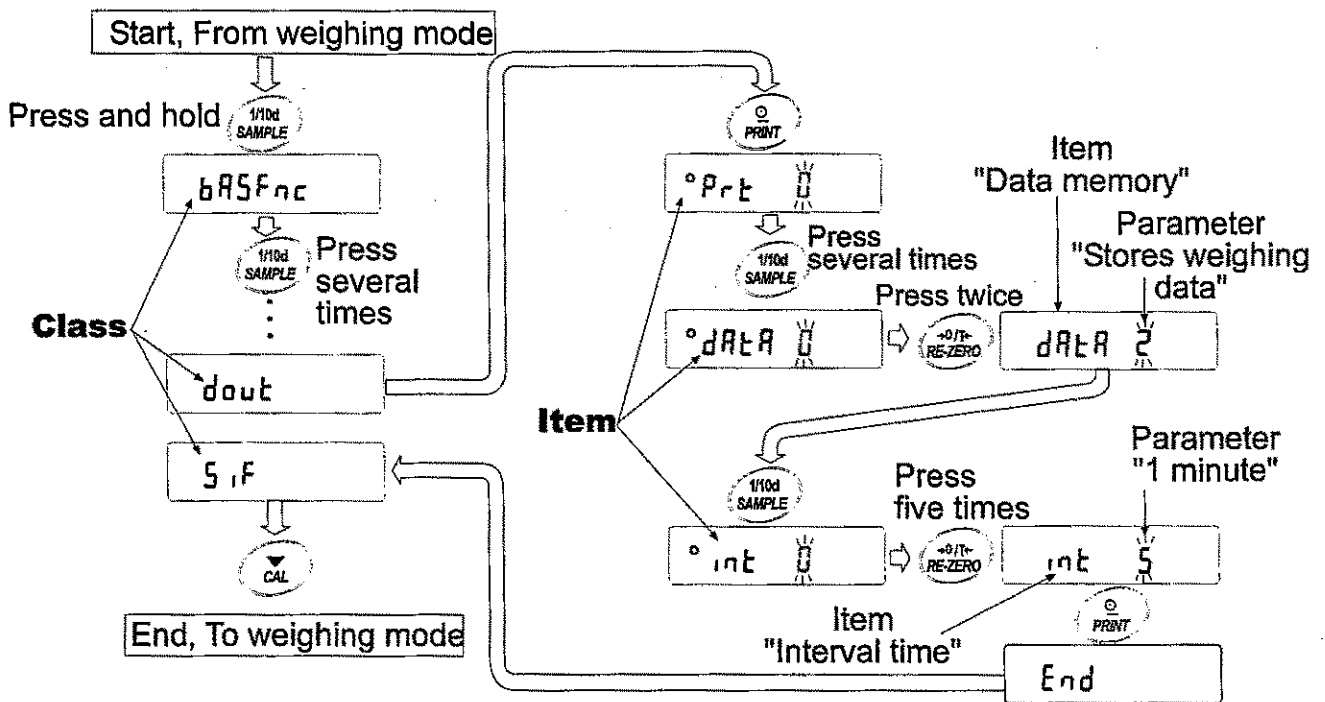

Note

The balance may not function properly, depending on the settings and the operating environment. Be sure to set the parameters correctly.

2-2 Display and Keys

Display/Key	Description
	The symbol "○" indicates that the parameter displayed is in effect.
	When pressed and held in the weighing mode, enters the function table mode. Selects the class or item in the function table mode.
	Changes the parameter.
	When a class is displayed, moves to an item in the class. When an item is displayed, stores the new parameter and displays the next class.
	When an item is displayed, cancels the new parameter and displays the next class. When a class is displayed, exits the function table mode and returns to the weighing mode.

2-3 Details of the Function Table

Class	Item	Parameter	Description		
bRSFnc Environment Display	Cond Condition	0	Fast response, sensitive value	FAST	
		1		MID.	
		2	Slow response, stable value	SLOW	
	St-b Stability band width	0	Stable when within ± 1 digit		
		1			
		2	Stable when within ± 3 digits		
	HoLd Hold function	0	OFF		Can be changed by response adjustment. With "HoLd 1" sets the averaging time.
		1	ON		With "HoLd 1", sets the stabilization range.
	Zrc Zero tracking	0	OFF		The stabilization indicator illuminates with the display fluctuation within the range. With "HoLd 1", sets the stabilization range.
		1	ON		Holds the display when stable in animal mode. With "HoLd 1", [ANIMAL] turns on.
	SPd Display refresh rate	0	5 times/second		Keeps zero display by tracking zero drift.
		1	10 times/second		Period to refresh the display
	Pnt Decimal point	0	Point (.)		Decimal point format
1		Comma (,)			
P-on Auto display-ON	0	OFF		Turns on the weighing mode display when AC adapter is connected.	
	1	ON			
P-off Auto display-OFF	0	OFF		Turns off the display after 10 minutes of inactivity.	
	1	ON (10 minutes)			
CS Capacity indicator	0	OFF		Capacity indicator. Zero: 0%	
	1	ON		Maximum capacity: 100%	
Add Accumulation function	0	OFF		Displays and outputs the total value of the weighing data.	
	1	ON			
rnc Display at start	0	Does not display		Select whether or not to display the smallest displayable weighing value at weighing start.	
	1	Displays			
CL Add Clock			See the balance instruction manual, "9-9 Clock and Calendar Function"	Confirms and sets the time and date. The time and date are added to output data.	
CP Fnc Comparator	CP Comparator mode	0	No comparison		
		1	Comparison, excluding "near zero" when stable value or overloaded		
		2	Comparison, including "near zero" when stable value or overloaded		
		3	Continuous comparison, excluding "near zero"		
		4	Continuous comparison, including "near zero"		
CP in Data input method	0	Sets the upper/lower limit values		Select CP hi or CP Lo.	
	1	Sets the reference value		Select CP rEF or CP Lnt.	
CP-r Comparison results	0	Added		Select whether or not to add the comparison results to the output data.	
	1	Not added			
CP-b Main display comparison	0	OFF		Displays the results on the main portion of the display in place of the weight value.	
	1	ON			
Displayed only when the GP-04 option is installed.	bEP- LO buzzer	0	OFF	Select whether or not to sound the LO buzzer.	
	bEP- OK buzzer	0	OFF	Select whether or not to sound the OK buzzer.	
	bEP- HI buzzer	0	OFF	Select whether or not to sound the HI buzzer.	

▪ Factory setting Note: "Digit" is a unit of minimum weighing value.

Class	Item	Parameter	Description	
CP_{Hi} Upper limit		See the balance instruction manual "9-10 Comparator Function"	Displayed when $CP_{in 0}$ is selected.	
CP_{Lo} Lower limit				
CP_{REF} Reference value		See the balance instruction manual "9-10 Comparator Function"	Displayed when $CP_{in 1}$ is selected.	
CP_{Lnt} Tolerance				
$dout$ Data output	Prt Data output mode	0	Key mode	Accepts the PRINT key only when the display is stable.
		1	Auto print mode A (Reference = zero)	Outputs data when the display is stable and
		2	Auto print mode B (Reference = last stable value)	conditions of $AP-P$, $AP-b$ and the reference value are met.
		3	Stream mode / Interval memory mode	With $dRA 0$, outputs data continuously; with $dRA 2$, uses interval memory.
	$AP-P$ Auto print polarity	0	Plus only	Displayed value > Reference
		1	Minus only	Displayed value < Reference
		2	Both	Regardless of displayed value
	$AP-b$ Auto print difference	0	10 digits	Difference between reference value and displayed value
		1	100 digits	
		2	1000 digits	
	dRA Data memory	0	Not used	Related items: Prt , int , $d-na$, $S-td$, $info$
		1	Stores unit mass in counting mode	
		2	Stores weighing data	
		3	Stores calibration data	
		4	Stores comparator settings	
	int Interval time	0	Every measurement	Interval time in the interval memory mode (with $Prt 3$, $dRA 2$)
		1	2 seconds	
		2	5 seconds	
		3	10 seconds	
		4	30 seconds	
		5	1 minute	
		6	2 minutes	
		7	5 minutes	
	$d-na$ Data number output	0	No output	See "11 DATA MEMORY".
1		Output		
$S-td$ Time/Date output	0	No output	Selects whether or not the time or date is added to the weighing data. For details, refer to "9-9 Clock and Calendar Function".	
	1	Time only		
	2	Date only		
$S-id$ ID number output	0	No output	Selects whether or not the ID number is output.	
	1	Output		

■ Factory setting

Class	Item	Parameter		Description
<i>dout</i> Data output	<i>PUSE</i> Data output pause	0	No pause	Selects the data output interval.
		1	Pause (1.6 seconds)	
	<i>AE-F</i> Auto feed	0	Not used	Selects whether or not auto feed is performed.
		1	Used	
	<i>inFo</i> GLP output	0	No output	Selects GLP output method. For how to set time and date to be added, refer to the balance instruction manual, "9-9: Clock and Calendar Function".
		1	AD-8121 format	
		2	General data format	
	<i>Ar-d</i> Zero after output	0	Not used	Adjusts zero automatically after data is output
1		Used		
<i>SIF</i> Serial interface	<i>bPS</i> Baud rate	0	600 bps	
		1	1200 bps	
		2	2400 bps	
		3	4800 bps	
		4	9600 bps	
		5	19200 bps	
	<i>bPr</i> Data bit, parity bit	0	7 bits, even	
		1	7 bits, odd	
		2	8 bits, none	
	<i>CrLF</i> Terminator	0	CR LF	CR: ASCII code 0Dh LF: ASCII code 0Ah
		1	CR	
	<i>TYPE</i> Data format	0	A&D standard format	See the balance instruction manual, "9-6 Description of Item "Data Format".
		1	DP format	
2		KF format		
3		MT format		
4		NU format		
5		CSV format		
<i>t-UP</i> Timeout	0	No limit	Selects the wait time to receive a command.	
	1	1 second		
<i>ErCd</i> AK, Error code	0	No output	AK: ASCII code 06h	
	1	Output		
<i>cts</i> CTS, RTS control	0	Not used	Controls CTS and RTS.	
	1	Used		
<i>dS Fnc</i> Density function	<i>Ldin</i> Liquid density input	0	Water temperature	Available only when density mode is selected.
		1	Liquid density	
<i>nLE</i> Programmable-unit (Multi-unit)		Sets an arbitrary coefficient.		Available only when programmable unit mode is selected.
<i>Unit</i> Unit		See the balance instruction manual, "4. WEIGHING UNITS".		
<i>CS in</i> Internal mass value correction		See the balance instruction manual, "7. CALIBRATION".		Displayed only when the internal mass value correction switch is set to 1.
<i>Rowt</i> Analog output	<i>Rn</i> Analog output mode	0	2-digit output	Displayed only when the GP-06 option is installed.
		1	3-digit output	
		2	Net full scale output	
		3	Gross full scale output	
	<i>SEL</i> Output digit selection	0	First digit	Displayed only when the GP-06 option is installed.
		1	Second digit	
		2	Third digit	
		3	Fourth digit	
		4	Fifth digit	
		5	Sixth digit	
<i>id</i> ID number setting		See the balance instruction manual "10. ID NUMBER AND GLP REPORT"		

▪ Factory setting

Caution

The balance may not transmit the data completely at the specified refresh rate, depending on the baud rate or data added to the weighing data such as time, date and ID number.

3. COMPARATOR OUTPUT (GP-04)

Comparator output, is the function to output the comparison results between the weighing data and upper/lower limit values. Whether or not to sound the buzzer when the contact output is shorted can be set.

3-1 Installing the GP-04 Option

Install the GP-04 option in the following procedures:

1. Remove the option cover, and then remove the RS-232C board.
2. Turn the board over so that the connectors can be accessed.
Remove the connectors from the RS-232C board.
They are difficult to remove, so use care.

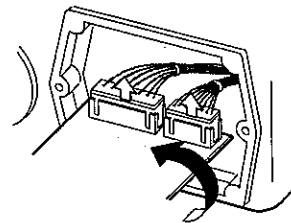
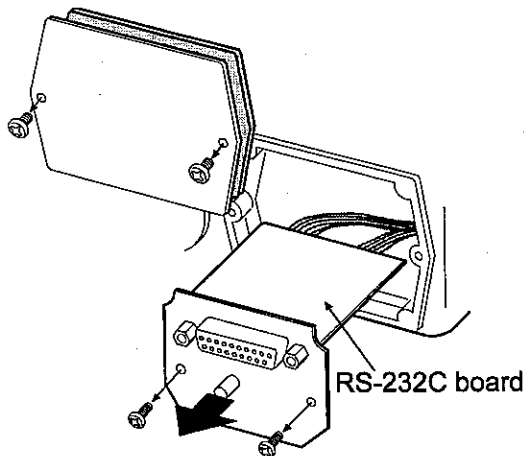

3. Connect the cables, removed from the RS-232C board, to the GP-04 board.
4. Secure the cables in the wire clip.

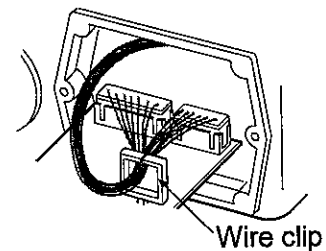
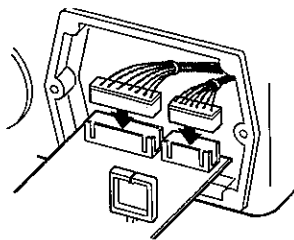

5. Turn the GP-04 board over so that the connectors face downward.
Insert the board into the display casing.
When inserting, lower the edge of the GP-04 board so that the GP-04 board will not touch the board located in the upper side of the casing.
Fasten the GP-04 panel with screws.

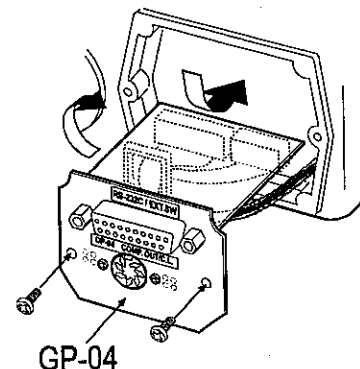

3-2 Specifications

The specifications of the comparator output are as follows:

Maximum contact voltage: 100 VDC

Maximum contact current: 100 mA DC

Maximum contact resistance: 20 Ω

Comparator output judgement conditions (when upper limit value \geq lower limit value):

Weighing data $>$ upper limit value: Activates the HI comparator output.

Upper limit value \geq weighing data \geq lower limit value: Activates the OK comparator output.

Weighing data $<$ lower limit value: Activates the LO comparator output.

Reference value setting: Input the upper and lower limit values digitally or using a sample.

Contact output: Select whether or not to and how to compare, using "CP", comparator mode of the balance function table.

Buzzer: Select whether or not to sound the buzzer, using "bEP", buzzer mode of the balance function table.

Panel view

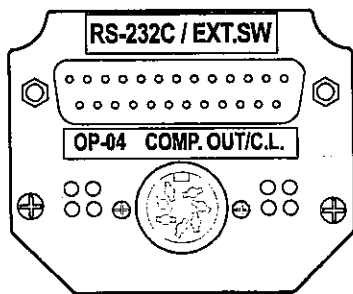

Circuit

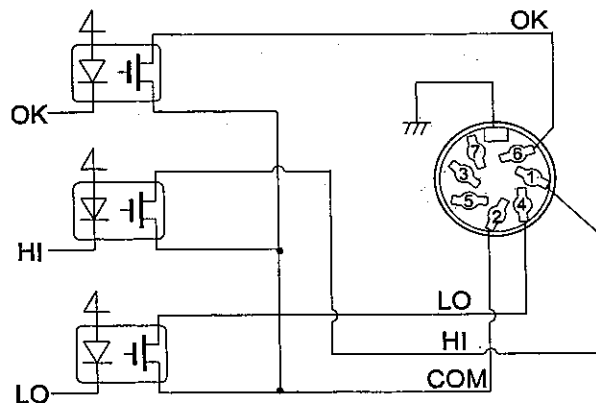

Pin assignments

Pin No.	Description
1	HI (Comparator)
2	COM (Comparator)
3	Sending loop (Current loop)
4	LO (Comparator)
5	Sending loop (Current loop)
6	OK (Comparator)
7	No connection
Housing	Shield

For details on current loop, pins 3 and 5, see "4-2 Current Loop Output (GP-04/GP-06) Specifications" on page 17.

3-3 Using the Comparator Output

To use the comparator output, perform the following four steps.

1. Connect the peripheral to the option's 7-pin DIN connector.
2. Set the "Comparator (EP_{Fnc})" of the balance function table. For details, see "2. FUNCTION TABLE".
3. Set the upper and lower limit values. For details, see "3-4 Setting the Upper and Lower Limit values".
4. Perform a weighing. The comparison results will be output.

When the weighing data is equal to or less than the upper limit value, and equal to or greater than the lower limit value, the OK comparator will be output.

Comparator output	LO	OK	HI
Weighing data > upper limit	Open	Open	Short
Upper limit \geq weighing data \geq lower limit	Open	Short	Open
Weighing data < lower limit	Short	Open	Open

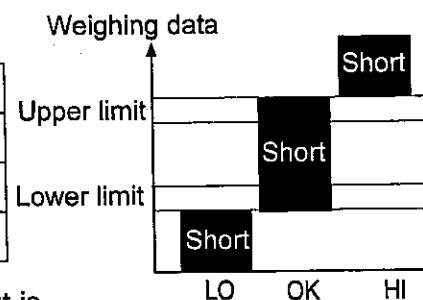

Whether or not to sound the buzzer when the contact output is shorted can be set in the "Buzzer mode (bEP)" of the "Comparator (EP_{Fnc})".

Note

When setting the upper and lower limit values, make sure that the upper limit value is greater than the lower limit value.

Comparator output

Class	Item	Parameter	Description	
[P Fnc Comparator	[P Comparator mode	0	No comparison	
		1	Comparison, excluding "near zero" when stable value or overloaded	
		2	Comparison, including "near zero" when stable value or overloaded	
		3	Continuous comparison, excluding "near zero"	
		4	Continuous comparison, including "near zero"	
	[P in Data input method	0	Sets the upper/lower limit values	Select [P h ₁ or [P L ₀ .
		1	Sets the reference value	Select [P rEF or [P Lnt.
	[P-r Comparison results	0	OFF	Select whether or not to add the comparison results to the output data.
		1	ON	
	[P-b Main display comparison	0	OFF	Displays the results on the main portion of the display in place of the weight value.
1		ON		
Displayed only when the GP-04 option is installed.	[P-LO LO buzzer	0	OFF	Select whether or not to sound the LO buzzer.
	[P-OK OK buzzer	0	OFF	Select whether or not to sound the OK buzzer.
	[P-HI HI buzzer	0	OFF	Select whether or not to sound the HI buzzer.
[P h ₁ Upper limit		See "3-4 Setting the Upper and Lower Limit Values" of this manual.	Displayed when [P in 0 is selected.	
[P L ₀ Lower limit				
[P rEF Reference value		See "3-4 Setting the Upper and Lower Limit Values" of this manual.	Displayed when [P in 1 is selected.	
[P Lnt Tolerance				

■ Factory setting

3-4 Setting the Upper and Lower Limit Values

The results of the comparison are indicated by **HI** **OK** **LO** on the display.

Operating conditions: ● No comparison

- Comparison when the weighing data is stable or overloaded, excluding "near zero"
- Comparison when the weighing data is stable or overloaded, including "near zero"
- Continuous comparison, excluding "near zero"
- Continuous comparison, including "near zero"

To compare, use:

- Upper limit value and lower limit value
- Reference value and tolerance value

Input method:

- Digital input
- Weighing input

Setting example 1

(Comparison when the weighing data is stable or overloaded, excluding "near zero", upper limit and lower limit)

Selecting a comparator mode

- 1 Press and hold the **SAMPLE** key until **bRSFnC** of the function table is displayed, then release the key.
- 2 Press the **SAMPLE** key several times to display **[P Fnc]**.
- 3 Press the **PRINT** key.
- 4 Press the **RE-ZERO** key several times to display **[P 1]**.
- 5 Press the **SAMPLE** key to display **[P in]**.
- 6 Press the **RE-ZERO** key several times to display **[P in 0]**.
- 7 Press the **PRINT** key to store the selected mode.

Entering the upper and lower limit values

- 8 With **[P H,]** displayed, press the **PRINT** key. The current setting of the upper limit value is displayed with all of the digits blinking.
 - When the current setting is not to be changed, press the **PRINT** or **CAL** key to proceed to step 9.
 - When the current setting is to be changed, press the **RE-ZERO** key. The balance is now in the digital input mode. To use the weighing input mode, press and hold the **MODE** key.

Digital input mode

Change the setting using the following keys.

SAMPLE key	To select the digit to change the value.
RE-ZERO key	To change the value of the digit selected.
MODE key	To switch the polarity.
PRINT key	To store the new setting and go to step 9.
CAL key	To cancel the new setting and go to step 9.

Weighing input mode

Press the **RE-ZERO** key. The balance displays **[00 g]**. Place a sample, with a mass that corresponds to the upper limit value, on the pan. Press the **PRINT** key to store the upper limit value. Remove the sample. The balance displays **[P L_u]**.

- 9 With **[P L_u]** displayed, press the **PRINT** key. The current setting of the lower limit value is displayed with all of the digits blinking.
 - When the current setting is not to be changed, press the **PRINT** or **CAL** key to proceed to step 10.
 - When the current setting is to be changed, press the **RE-ZERO** key. The balance is now in the digital input mode. To use the weighing input mode, press and hold the **MODE** key.
Enter the lower limit value in the same way as described in step 8. Then, go to step 10.
- 10 Press the **CAL** key to exit the comparator function and return to the weighing mode.

Setting example 2

(Continuous comparison, including "near zero", reference value and tolerance value)

Selecting a comparator mode

- 1 Press and hold the **SAMPLE** key until **bRSFnC** of the function table is displayed, then release the key.
- 2 Press the **SAMPLE** key several times to display **CP FnC**.
- 3 Press the **PRINT** key.
- 4 Press the **RE-ZERO** key several times to display **CP 4**.
- 5 Press the **SAMPLE** key to display **CP in**.
- 6 Press the **RE-ZERO** key several times to display **CP in 1**.
- 7 Press the **PRINT** key to store the selected mode.

Entering the reference and tolerance values

- 8 With **CP rEF** displayed, press the **PRINT** key. The current setting of the reference value is displayed with all the digits blinking.
 - When the current setting is not to be changed, press the **PRINT** or **CAL** key to proceed to step 9.
 - When the current setting is to be changed, press the **RE-ZERO** key. The balance is now in the digital input mode. To use the weighing input mode, press and hold the **MODE** key.

Digital input mode

Change the setting using the following keys.

SAMPLE key	To select the digit to change the value.
RE-ZERO key	To change the value of the digit selected.
MODE key	To switch the polarity.
PRINT key	To store the new setting and go to step 9.
CAL key	To cancel the new setting and go to step 9.

Weighing input mode

Press the **RE-ZERO** key. The balance displays **00 g**. Place a sample, with a mass that corresponds to the reference value, on the pan. Press the **PRINT** key to store the reference value. Remove the sample and go to step 9.

- 9 With **CP Lnt** displayed, press the **PRINT** key. The current setting of the tolerance value is displayed with all the digits blinking.
 - When the current setting is not to be changed, press the **PRINT** or **CAL** key to proceed to step 10.
 - When the current setting is to be changed, press the **RE-ZERO** key. The balance is now in the digital input mode. Change the setting using the following keys.

SAMPLE key	To select the digit to change the value.
RE-ZERO key	To change the value of the digit selected.
PRINT key	To store the new setting and go to step 10.
CAL key	To cancel the new setting and go to step 10.

Notes: Enter the tolerance value in percentage, with the reference value as 100%.

Only the digital input mode is available for setting the tolerance value.

The **MODE key is not used to set the tolerance value.**

- 10 Press the **CAL** key to exit the comparator function and return to the weighing mode.

Notes

When Pound/Ounce is selected as a weighing unit, enter the values in ounces for comparison.

In the density mode, comparison is performed to the density obtained.

3-5 Example of Use

The following example uses the AD-8951 comparator light, which is sold separately, to display the comparison result in red, green, or orange.

- Using the AX-KO507-W200 cable, which is sold separately, connect the comparator light to the balance as shown below.

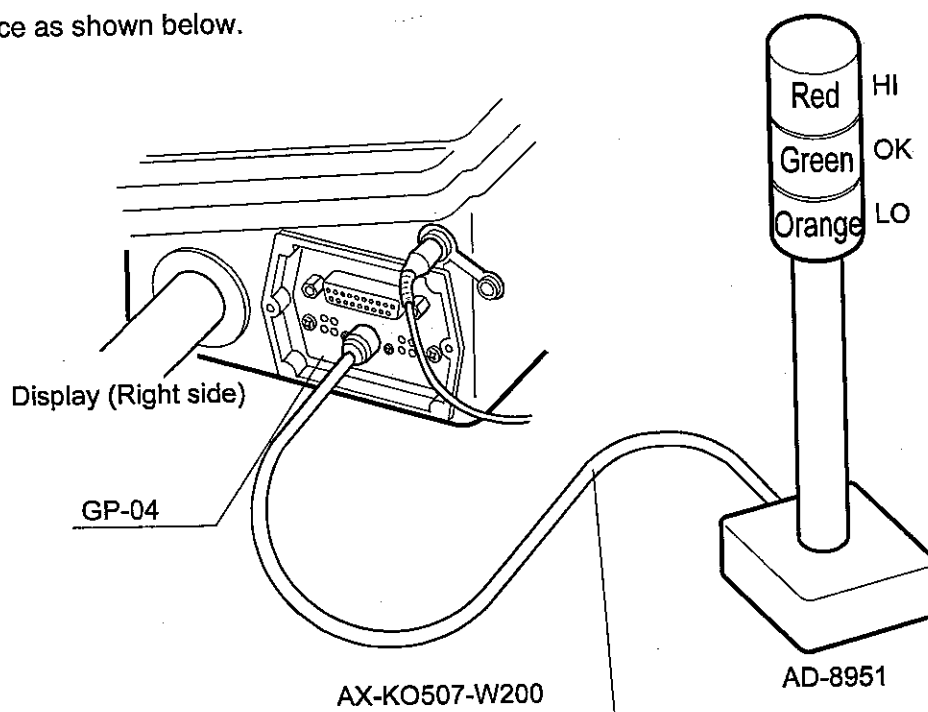

- Set the "Comparator (CP Fnc)" of the balance function table as follows:
 - CP 3 Compares the result excluding the data near zero continuously.
 - CP in 0 Inputs the upper or lower limit values.
 - bEP- 1 Sounds the buzzer for LO.
 - bEP- 0 Does not sound the buzzer for OK.
 - bEP- 1 Sounds the buzzer for HI.

- Set the upper and lower limit values as follows:

CP Hi 10.100 kg (Upper limit)

CP Lo 9.900 kg (Lower limit)

- The comparator and buzzer functions as follows, depending on the comparison result.

Weighing data	Comparator light	Buzzer
9.000 kg	Orange	Sounds
10.000 kg	Green	Does not sound
11.000 kg	Red	Sounds

4. SERIAL OUTPUT

4-1 RS-232C (GP-04) Specifications

D-Sub 25 pin numbers

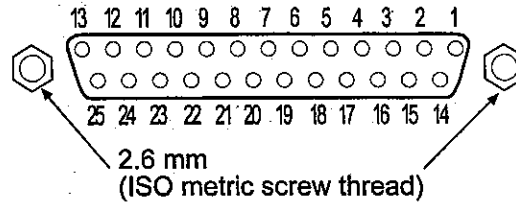

D-Sub 25 pin assignments

Pin No.	Signal name	Interface type	Direction	Description
1	FG			Frame ground
2	RXD	RS-232C	Input	Receive data
3	TXD	RS-232C	Output	Transmit data
4	RTS	RS-232C	Input	Ready to send
5	CTS	RS-232C	Output	Clear to send
6	DSR	RS-232C	Output	Data set ready
7	SG	RS-232C/external contact input	-	Signal ground
18	PRINT	External contact input	Input	Same as the PRINT key
19	RE-ZERO	External contact input	Input	Same as the RE-ZERO key
Others	-	-	-	No connection

RS-232C

The balance is a DCE device. Connect the balance to a personal computer (DTE) using a straight through cable.

- Transmission system : EIA RS-232C
- Transmission form : Asynchronous, bi-directional, half duplex
- Transmission rate : 10 times/second or 5 times/second (same as data refresh rate)
- Data format :
 - Baud rate : 600, 1200, 2400, 4800, 9600, 19200bps
 - Data bits : 7 or 8 bits
 - Parity : Even, Odd (Data 7 bits)
None (Data 8 bits)
 - Stop bit : 1 bit
(When sending, 2 bits; receiving, 1 bit.
A personal computer will function with either setting.)
 - Code : ASCII

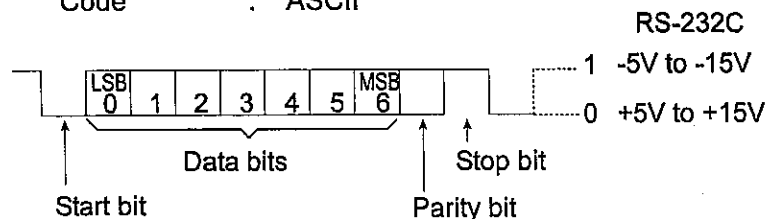

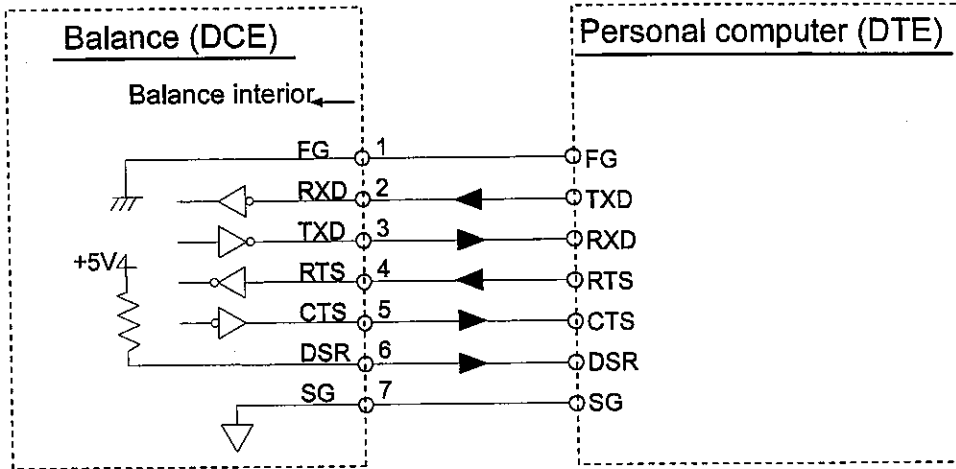

External contact input

By connecting pin 18 to pin 7, or pin 19 to pin 7, for more than 100 ms, the same operation as performed by pressing the **RE-ZERO** key or the **PRINT** key, will be performed.

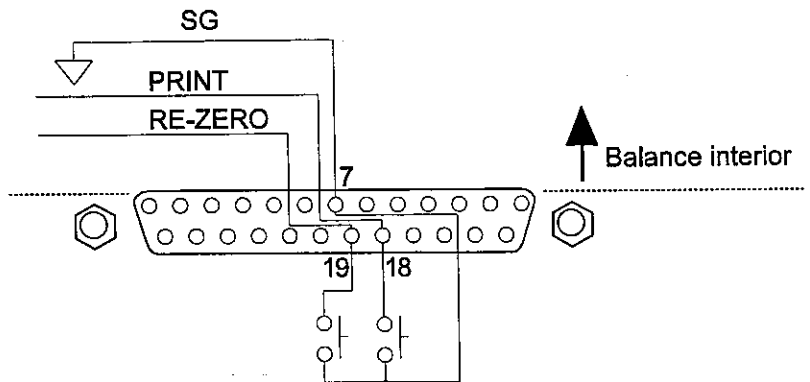

Use of example

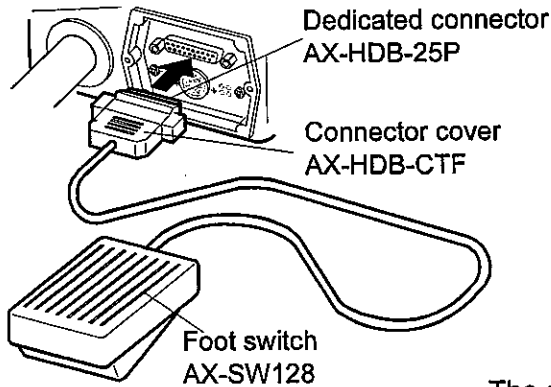

The external input connector (AX-HDB-25P/CTF) and the foot switch (AX-SW128) are sold separately.

4-2 Current Loop Output (GP-04/GP-06) Specifications

The specifications of the current loop interface are as follows:

Transmission system	20 mA current loop (Passive)
Transmission	Asynchronous, uni-directional (Only from the balance)
Data format	Baud rate: 600, 1200, 2400, 4800, 9600, 19200 bps
	Data: 7 or 8 bits
	Parity: Even, Odd (Data 7 bits)
	None (Data 8 bits)
	Stop bit: 1 bit
	Code: ASCII

Data	Current loop (20 mA)
1	20 mA
0	0 mA

Notes

To use current loop, an external power supply that provides 20 mA, is required.

The maximum rated voltage of the current loop is 25 V.

When a baud rate of 4800 bps or higher is used, communication may not be performed properly.

Circuit

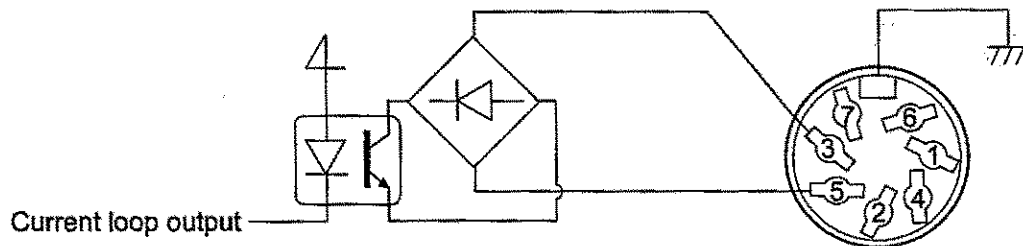

Pin assignments

GP-04

Pin No.	Description
1	HI
2	COM
3	Sending loop (Current loop)
4	LO
5	Sending loop (Current loop)
6	OK
7	No connection
Housing	Shield

GP-06

Pin No.	Description
1	No connection
2	Analog GND
3	Sending loop (Current loop)
4	No connection
5	Sending loop (Current loop)
6	No connection
7	Analog output
Housing	Shield

4-3 Connection to the AD-8121 Printer

Set the following parameters to use the AD-8121 printer.

Function setting	Description
<i>dout Prt</i> 0-3	Selects a print mode.
<i>dout RP-</i> P 0-2	Selects the polarity for the auto print mode.
<i>dout RP-</i> b 0-2	Selects the auto print difference.
<i>dout PUSE</i> 0,1	Selects data output pause.
<i>S iF bPS</i> 2 Factory setting	2400 bps
<i>S iF bPr</i> 0 Factory setting	7 bits, Even parity check
<i>S iF CrLF</i> 0 Factory setting	CR, LF
<i>S iF Cts</i> 0 Factory setting	CTS and RTS control, not used

When "MODE 1" or "MODE 2" of the AD-8121 printer is used	
<i>S iF tYPE</i> 0 Factory setting	A&D standard format

When "MODE 3" of the AD-8121 printer is used.	
<i>S iF tYPE</i> 1	DP format

When data is transmitted continuously. When all memory data is transmitted at one time.	
<i>dout PUSE</i> 1	Uses pause.

AD-8121 Printer

- Compact thermal dot-matrix printer
- Statistical function, clock and calendar function, interval print function, graphic print function, terminal mode
- 5 x 7 dots, 16 characters per line
- Print paper (AX-PP143, 45 (W) x 50 (L) mm , ø65 mm)
- AC adapter or alkaline battery

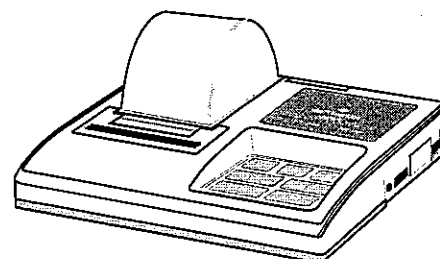

4-4 Description of the Item "Data output mode"

The parameter setting of the "Data output mode (*Prt*)" applies to the performance when the "Data memory (*dRtR*)" parameter is set to "2" (to store the weighing data) and when the data is transmitted using the RS-232C interface.

Key mode

When the **PRINT** key is pressed with the stabilization indicator turned on, the balance outputs or stores the weighing data and the display blinks one time.

Required setting *dout Prt* 0 Key mode

Auto print modes A and B

When the displayed value is stable and the conditions of "Auto print polarity", "Auto print difference" and reference value are met, the balance outputs or stores the weighing data.

When the **PRINT** key is pressed with the stabilization indicator turned on, the balance outputs or stores the data and the display blinks one time.

Mode A: Required setting	<i>dout</i>	<i>Prt 1</i>	Auto print mode A (reference = zero)
	<i>dout</i>	<i>AP-P</i>	Auto print polarity
	<i>dout</i>	<i>AP-b</i>	Auto print difference

Example "For weighing each time a sample is placed and removed, with "A-r-d" set to "1" (to adjust zero after the data is output)."

Mode B: Required setting	<i>dout</i>	<i>Prt 2</i>	Auto print mode B (reference = last stable value)
	<i>dout</i>	<i>AP-P</i>	Auto print polarity
	<i>dout</i>	<i>AP-b</i>	Auto print difference

Example "For weighing while a sample is added."

Stream mode

The balance outputs the weighing data continuously regardless of the display condition. The display does not blink in this mode. This mode is not available and the interval memory mode is used when the "Data memory (*dAtR*)" parameter is set to "2" (to store the weighing data).

Required setting	<i>dout</i>	<i>Prt 3</i>	Stream mode
	<i>dout</i>	<i>dAtR 0</i>	Data memory function is not used.
	<i>bASFnC</i>	<i>SPd</i>	Display refresh rate
	<i>SIF</i>	<i>bPS</i>	Baud rate

Example "For monitoring data on a computer"

Caution

The balance may not transmit the data completely at the specified refresh rate, depending on the baud rate or data added to the weighing data such as time, date and ID number.

Interval memory mode

The weighing data is periodically stored in memory.

Required setting	<i>dout</i>	<i>Prt 3</i>	Interval memory mode
	<i>dout</i>	<i>dAtR 2</i>	Data memory function is used. Stores weighing data.
	<i>dout</i>	<i>int</i>	Interval time
Optional setting	<i>dout</i>	<i>S-t d 1, 2, or 3</i>	Adds the time and date.

Example "For periodical weighing without a computer command and to output all of the data, to a computer, at one time"

4-5 Description of the Item "Data format"

A&D standard format *SIF TYPE 0*

This format is used when the peripheral equipment can receive the A&D format. If an AD-8121 is used, set the printer to MODE 1 or 2.

- This format consists of fifteen characters excluding the terminator.
- A header of two characters indicates the balance condition.
- The polarity sign is placed before the data with the leading zeros. If the data is zero, the plus sign is used.
- The unit, consisting of three characters, follows the data.

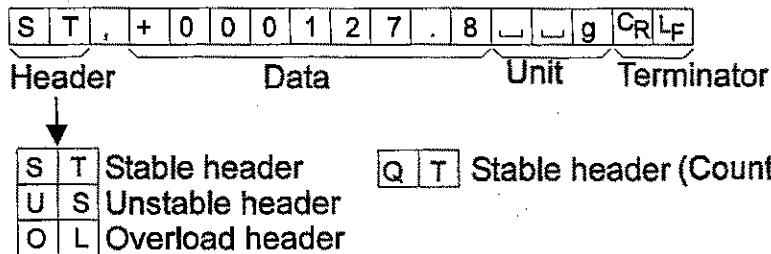

DP (Dump print) format *SIF TYPE 1*

This format is used when the peripheral equipment can not receive the A&D format. If an AD-8121 is used, set the printer to MODE 3.

- This format consists of sixteen characters excluding the terminator.
- A header of two characters indicates the balance condition. No overload header is used.
- The polarity sign is placed before the data, with spaces in place of leading zeros, if the data is not zero or overloaded.
- The unit, consisting of three characters, follows the data.

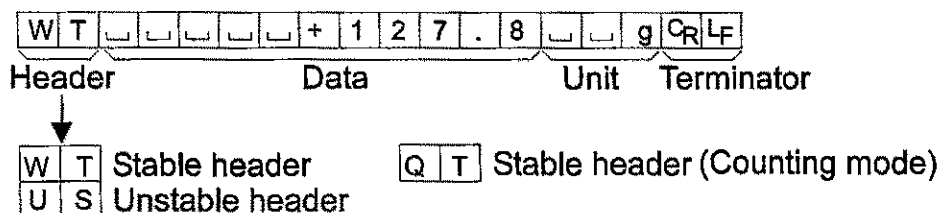

KF format *SIF TYPE 2*

This is the Karl-Fischer moisture meter format and is used when the peripheral equipment can only communicate using this format.

- This format consists of fourteen characters excluding the terminator.
- This format has no header characters.
- The polarity sign is placed before the data, with spaces in place of leading zeros, if the data is not zero or overloaded.
- This format outputs the unit only for a stable value.

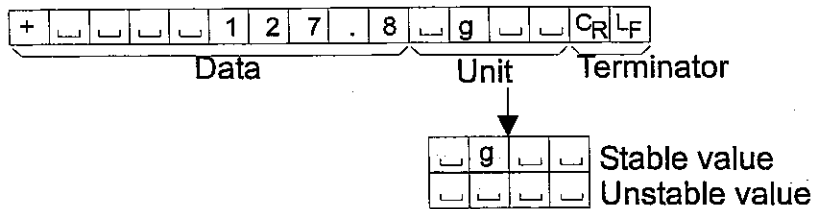

MT format *S, F TYPE 3*

- A header of two characters indicates the balance condition.
- The polarity sign is used only for negative data.
- The weighing data uses spaces in place of the leading zeros.
- The character length of this format changes dependent upon the unit

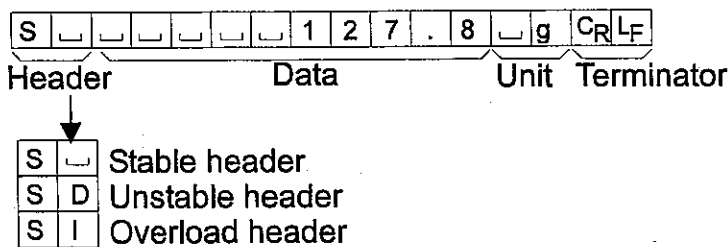

NU (numerical) format *S, F TYPE 4*

This format outputs only numerical data.

- This format consists of nine characters excluding the terminator.
- The polarity sign is placed before the data with the leading zeros. If the data is zero, the plus sign is used.

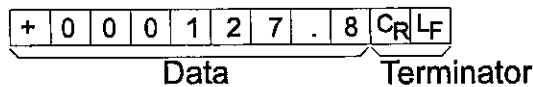

CSV format *S, F TYPE 5*

- Separates the data of A&D standard format and the unit by a comma (,).
- Outputs the unit even when the data is overloaded.
- When ID number, data number, time and date are added, outputs ID number, data number, date, time and weighing data in this order and separates each item by a comma and treats all the items as one group of data.

LAB-123, No,012, 2001/12/31, 12:34:56, ST,+000127.8, g<CR><LF>

ID number Data number Date Time Weighing data

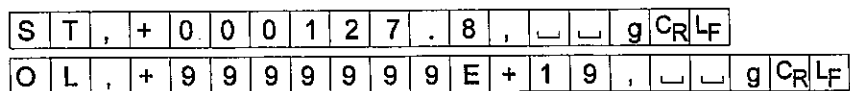

4-6 Description of the Data Format Added to the Weighing Data

ID number *dout 5-id 1*

The number to identify a specific balance.

- This format consists of seven characters excluding the terminator.

L	A	B	-	1	2	3	CR	LF
---	---	---	---	---	---	---	----	----

Data number *dout d-no 1*

This format outputs the data number just before the data is transmitted using the RS-232C interface.

- This format consists of six characters excluding the terminator.
- When CSV format (*5 IF TYPE 5*) is selected, the period (.) is replaced with a comma (,).

N	0	.	0	0	1	CR	LF
---	---	---	---	---	---	----	----

Data number Terminator

Date *dout 5-td 2 or 3*

- The date output order can be changed in "Clock (*CL ADJ*)". Outputs the year in four-digit format.

2	0	0	1	/	1	2	/	3	1	CR	LF
---	---	---	---	---	---	---	---	---	---	----	----

Time *dout 5-td 1 or 3*

- Outputs time in 24-hour format.

1	2	:	3	4	:	5	6	CR	LF
---	---	---	---	---	---	---	---	----	----

Tare value *dout DATA 5*

- When the tare value in memory is recalled, the tare value is output before the weighing data.

P	T	,	+	0	0	0	1	2	3	.	4	□	□	g	CR	LF
---	---	---	---	---	---	---	---	---	---	---	---	---	---	---	----	----

Comparison results

- By setting "Comparison results (*CP-r*)" of the function table to "I", the comparison results can be added to the data output using the RS-232C serial interface. Use A&D standard format (*TYPE 0*). The AD-8121 printer can not be used.

The comparison results are added after the header in A&D standard format as below.

S	T	,	O	K	,	+	0	1	2	.	3	4	5	6	□	k	g	CR	LF
---	---	---	---	---	---	---	---	---	---	---	---	---	---	---	---	---	---	----	----

Header Comparison Data Unit Terminator
results

H	I	When the comparison result is HI
O	K	When the comparison result is OK
L	O	When the comparison result is LO
-	-	Not applicable

Note

When the data described above is added to the weighing data, the output is in the following order: ID number, Data number, Date, Time and Weighing data.

4-7 Data Format Examples

Stable

° 12.7 9

A&D	S	T	,	+	0	0	0	0	1	2	.	7	␣	␣	g	C _R	L _F
DP	W	T	␣	␣	␣	␣	␣	␣	+	1	2	.	7	␣	␣	g	C _R L _F
KF	+	␣	␣	␣	␣	␣	1	2	.	7	␣	g	␣	␣	␣	C _R L _F	
MT	S	␣	␣	␣	␣	␣	␣	␣	1	2	.	7	␣	␣	g	C _R L _F	
NU	+	0	0	0	0	1	2	.	7	C _R	L _F						

Unstable

-1836.9 9

A&D	U	S	,	-	0	0	1	8	3	6	.	9	␣	␣	g	C _R	L _F
DP	U	S	␣	␣	␣	␣	-	1	8	3	6	.	9	␣	␣	g	C _R L _F
KF	-	␣	␣	␣	1	8	3	6	.	9	␣	␣	␣	␣	␣	C _R L _F	
MT	S	D	␣	␣	␣	␣	-	1	8	3	6	.	9	␣	␣	g	C _R L _F
NU	-	0	0	1	8	3	6	.	9	C _R	L _F						

Overload Positive error

E 9

A&D	O	L	,	+	9	9	9	9	9	9	9	E	+	1	9	C _R	L _F
DP	␣	␣	␣	␣	␣	␣	␣	␣	␣	␣	␣	␣	␣	␣	␣	␣	C _R L _F
KF	␣	␣	␣	␣	␣	␣	H	␣	␣	␣	␣	␣	␣	␣	␣	␣	C _R L _F
MT	S	I	+	C _R	L _F												
NU	+	9	9	9	9	9	9	9	9	C _R	L _F						

Overload Negative error

-E 9

A&D	O	L	,	-	9	9	9	9	9	9	E	+	1	9	C _R	L _F	
DP	␣	␣	␣	␣	␣	␣	␣	␣	-	E	␣	␣	␣	␣	␣	␣	C _R L _F
KF	␣	␣	␣	␣	␣	␣	L	␣	␣	␣	␣	␣	␣	␣	␣	␣	C _R L _F
MT	S	I	-	C _R	L _F												
NU	-	9	9	9	9	9	9	9	9	C _R	L _F						

- ␣ Space, ASCII 20h
- C_R Carriage Return, ASCII 0Dh
- L_F Line Feed, ASCII 0Ah

Units		A&D	D.P.	KF	MT
g	g	┌┌g	┌┌g	┌g┌┌	┌g
kg	kg	┌kg	┌kg	┌kg┌	┌kg
Counting mode	pcs	┌PCS	┌PCS	┌p c s	┌PCS
Precent mode	%	┌┌%	┌┌%	┌%┌┌	┌%
Ounce (Avoir)	oz	┌oz	┌oz	┌oz┌	┌oz
Pound	lb	┌lb	┌lb	┌lb┌	┌lb
Pound Ounce	┌ oz	┌oz	┌oz	┌oz┌	┌oz
Troy Ounce	ozt	┌ozt	┌ozt	┌ozt	┌ozt
Metric Carat	ct	┌ct	┌ct	┌ct┌	┌ct
Momme	mom	┌mom	┌mom	┌mom	┌mo
Pennyweight	dwt	┌dwt	┌dwt	┌dwt	┌dwt
Tael (HK general, Singapore)	TL	┌tl	┌tl	┌tl s	┌tl
Tael (HK, jewelry)	TL	┌tl	┌tl	┌tl h	┌tl
Tael (Taiwan)	TL	┌tl	┌tl	┌tl t	┌tl
Tael (China)	TL	┌tl	┌tl	┌tl c	┌tl
Tola (India)	t	┌┌t	┌┌t	┌t o l	┌t
Messghal	MS	┌mes	┌mes	┌M S┌	┌m
Density	DS	┌DS	┌DS	┌D S┌	┌DS
Multi	(Blank)	┌┌┌	┌┌┌	┌┌┌┌	┌

┌ Space, ASCII 20h

Note

When "Pound Ounce" is selected, the data is output with the unit of ounce (oz).

4-8 Connection to a Computer

The GP series balance is of the DCE type (Data Communication Equipment), which can be connected to a personal computer using the RS-232C interface.

Before connection, read the personal computer manual thoroughly.

Use a standard DCE cable for connection (cable type: straight-through).

When the personal computer type is a DOS/V with a 9-pin port, use a straight-through cable with a 25-pin male connector and a 9-pin female connector.

4-9 Using Windows Communication Tools (WinCT)

When Windows 95 or 98 is used as an operating system in a personal computer, the provided WinCT software can be used to transmit the weighing data to the personal computer.

The WinCT software has two communication methods: "RsCom" and "RsKey". For details on WinCT, refer to the WinCT instruction manual.

- RsCom**
- Can transmit commands to control the balance.
 - Can make bi-directional communication between the balance and a personal computer using the RS-232C interface.
 - Can display or store the data using a text file format. Can also print the data using a printer connected to the personal computer.
 - When several ports of a personal computer have balances connected, can communicate with each balance simultaneously.
 - Can share a personal computer with other application software.
 - Can receive the balance GLP report.

- RsKey**
- Can transmit the weighing data output from the balance directly to other application software such as Microsoft Excel.
 - Can be used with most application software.
 - Can receive the balance GLP report.

Note

Windows and Excel are registered trademarks of Microsoft Corporation.

4-10 Using the WinCT software, the balance can do the following:

- 1 Analyzing the weighing data and the statistics with "RsKey"
The weighing data can be input directly into an Excel worksheet. Then, Excel can analyze the data to obtain total, average, standard deviation, maximum and minimum value, and display them in a graph.
- 2 Controlling the balance using commands from a personal computer
By using "RsCom", the personal computer sends commands such as "re-zero" or "send weighing data" to the balance and controls the balance.
- 3 Printing the balance GLP report using your printer
The balance GLP report can be printed using a printer connected to the personal computer.
- 4 Receiving weighing data at a certain interval
The weighing data can be received at a certain interval and data characteristic with elapsed time can be obtained.
- 5 Using the GP series balance memory function
The data can be stored in the balance's memory. Of the data stored, the weighing data and calibration data can be transmitted to a personal computer at one time.
- 6 Using a personal computer as an external indicator
With the "RsKey" test mode function, a personal computer can be used as an external weight indicator for the balance. (To do this, set the balance data output mode to stream mode.)

4-11 Commands

Note

A command has a terminator added, that is specified using "SIF [rLF]" of the function table, and is sent to the balance.

Commands to query weighing data	
C	Cancels the S or SIR command.
Q	Requests the weighing data immediately.
S	Requests the weighing data when stabilized.
SI	Requests the weighing data immediately.
SIR	Requests the weighing data continuously.
Commands to control the balance	
CAL	Same as the CAL key.
OFF	Turns the display off.
ON	Turns the display on.
P	Same as the ON:OFF key
PRT	Same as the PRINT key
R	Same as the RE-ZERO key
SMP	Same as the SAMPLE key.
U	Same as the MODE key
UN:mm	Recalls the unit mass values in memory. (mm indicates 01-50)
?UN	Requests the unit mass numbers in memory.
UW:*****. * $\square\square$ g	Changes the unit mass value. (Only "g" is available as a unit.) Command e.g.: +002000.0 $\square\square$ g (Set the unit mass value to 2000.0 g: \square indicates a space.)
?UW	Requests the unit mass value.
CN:mm	Recalls the upper/lower limit value in memory (mm indicates 01-20)
?CN	Requests the upper/lower limit value code number of the selected value.
HI:*****. * $\square\square$ g	Sets the upper limit values. Command e.g.: HI:+002000.0 $\square\square$ g (To set the upper limit value to 2000.0 g: \square indicates a space.)
LO:*****. * $\square\square$ g	Sets the lower limit values. Command e.g.: LO:+001000.0 $\square\square$ g (To set the lower limit value to 1000.0 g: \square indicates a space.)
?HI	Requests the upper limit value.
?LO	Requests the lower limit value.
PN:mm	Recalls the tare value in memory. (mm indicates 01-20)
?PN	Request the tare number of the selected value. (mm indicates 01-20)
PT:*****. * $\square\square$ g	Sets the tare value. Command e.g.: PT:+001000.0 $\square\square$ g (To set the tare value to 1000.0 g: \square indicates a space.)
?PT	Request the tare value.
MCL	Deletes all data in memory.
MD:nnn	Deletes data with the data number nnn.
?MA	Outputs all weighing data in memory.
?MQnnn	Outputs data with the data number nnn.
?MX	Outputs the number of data in memory (the last data number)

Notes

When a unit is required in commands such as a "PT:" command, use the 3-digit unit code of the A&D standard format.

nnn indicates a three-digit numerical value.

4-12 Acknowledge Code and Error Codes

When the "Serial interface function (*SIF*)" parameter is set to "Error Code"; the balance outputs <AK> code or error code to each command as follows:

<AK> (06h) Acknowledge in ASCII code.

- When the balance receives a command to request data and can not process it, the balance transmits an error code (EC, Exx).

When the balance receives a command to request data and can process it, the balance outputs the data.

- When the balance receives a command to control the balance and can not process it, the balance transmits an error code (EC, Exx).

When the balance receives a command to control the balance and can process it, the balance transmits the acknowledge code.

Among commands to control the balance, the following transmit the acknowledge code both when the balance receives the command and when the balance has accomplished the command. If the command can not be processed properly, the balance transmits an error code (EC, Exx). This error can be released using the CAL command.

CAL command (Calibration command) ON command (Display ON command)

P command (Display ON/OFF command) R command (RE-ZERO command)

- When a communication error has occurred due to external noise, or a parity error has occurred due to transmission error, the balance transmits an error code. In this case, send the command again.

4-13 Control Using CTS and RTS

Depending on the "CTS" parameter of "Serial interface (*SIF*)", the balance performs as follows:

CTS 0

Regardless of whether the balance can receive a command or not, the balance keeps the CTS line Hi. The balance outputs data regardless of the condition of the RTS line.

CTS 1

The CTS line is kept Hi normally. When the balance can not receive the next command (e.g. while the balance is processing last command), the balance sets the CTS line to Lo. The balance confirms the level of the RTS line before outputting a set of data. If the RTS level is Hi, the balance outputs data. If the RTS level is Lo, data is not output (The data is canceled).

4-14 Settings Related to RS-232C

Concerning the RS-232C, the balance has two functions: "Data output (*daout*)" and "Serial interface (*SIF*)". Set each function as necessary.

5. ANALOG OUTPUT (GP-06)

5-1 Installing the GP-06 Option

Install the GP-06 option in the following procedures:

1. Remove the option cover, then remove the RS-232C board.

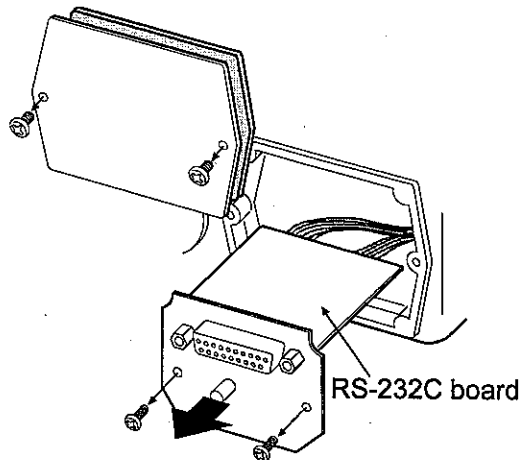

2. Turn the board over so that the connectors can be accessed.
Remove the connectors from the RS-232C board.
They are difficult to remove, so use care.

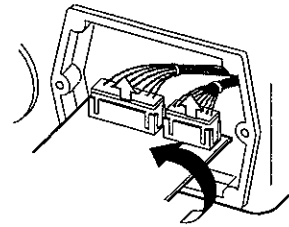

3. Connect the cables, removed from the RS-232C board, to the GP-06 board.

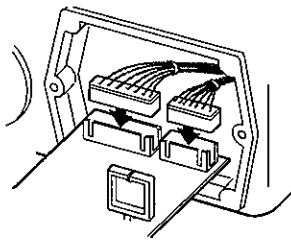

4. Secure the cables in the wire clip.

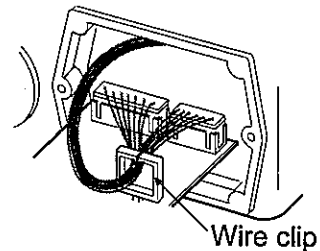

5. Turn the GP-06 board over so that the connectors face downward.
Insert the board into the display casing.
When inserting, lower the edge of the GP-06 board so that the GP-06 board will not touch the board located in the upper side of the casing.
Fasten the GP-06 panel with screws.

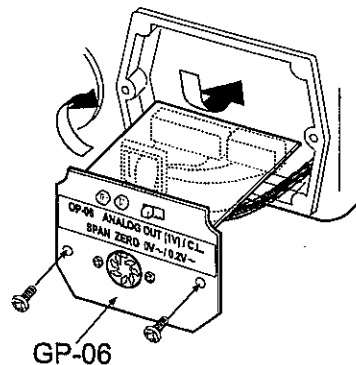

5-2 Analog Output (GP-06) Specifications

The specifications of the analog output unit (GP-06) are as follows:

Output impedance	100 Ω or less
Linearity	$\pm 0.3\%$ or less
Output connector	7-pin DIN connector
Pin connections	Output Pin 7 GND Pin 2
Output range	0 V-1 V (With the slide switch set to "0V~") 0.2 V-1 V (With the slide switch set to "0.2V~")
Input impedance of the device connected	10 k Ω or greater

Circuit

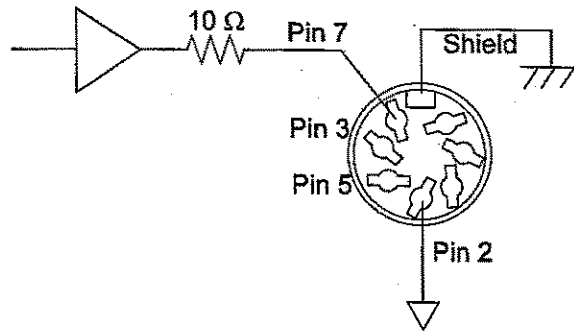

Current loop output specifications

The specifications of the current loop interface are as follows:

(For details, see "4-2 Current Loop Output (GP-04/GP-06) Specifications" on page 17.)

Transmission system	20 mA current loop (Passive)
Transmission	Asynchronous, uni-directional (Only from the balance)
Data format	Baud rate: 600, 1200, 2400, 4800, 9600 19200 bps
	Data: 7 or 8 bits
	Parity: Even, Odd (Data 7 bits) None (Data 8 bits)
	Stop bit: 1 bit or 2 bits
	Code: ASCII

Data	Current loop (20 mA)
1	20 mA
0	0 mA

Notes

To use current loop, an external power supply that provides 20 mA is required.

The maximum rated voltage of the current loop is 25 V.

When a baud rate of 4800 bps or higher is used, communication may not be performed properly.

Pin assignments

Pin No.	Description
1	No connection
2	Analog GND (0 V)
3	Sending loop
4	No connection
5	Sending loop
6	No connection
7	Analog output
Housing	Shield

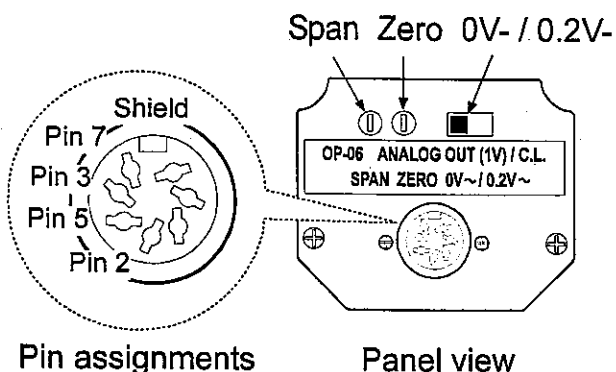

5-3 Analog Output (R_{out})

The "Analog output (R_{out})" of the function table can be selected when the GP-06 option is installed in the balance.

Analog output function table

Item	Parameter	Description
R_n Analog output mode	0	2-digit output Converts the consecutive 2 digits, with the digit selected in SEL as the least, to voltage and outputs.
	1	3-digit output Converts the consecutive 3 digits, with the digit selected in SEL as the least, to voltage and outputs.
	▪ 2	Net full scale output Outputs 0.000 V when the net weight is zero. Outputs 1.000 V when the net weight is full scale. Outputs 0.000 V when the display is set to zero using the RE-ZERO key.
	3	Gross full scale output Outputs 0.000 V when the gross weight is zero. Outputs 1.000 V when the gross weight is full scale. Tare operation using the RE-ZERO key will not affect the output. (Note: If the tare is extremely light, tare operation might change the zero point, thus it will affect the output.)
SEL Output digit selection		Select the least digit to be output in the mode selected in R_n . Only available when 0 or 1 is selected as the output mode.
	▪ 0	Select the first digit as the least.
	1	Select the second digit as the least.
	2	Select the third digit as the least.
	3	Select the fourth digit as the least.
	4	Select the fifth digit as the least.
5	Select the sixth digit as the least.	

▪ Factory setting

Setting example

When $R_n 0$ is set:

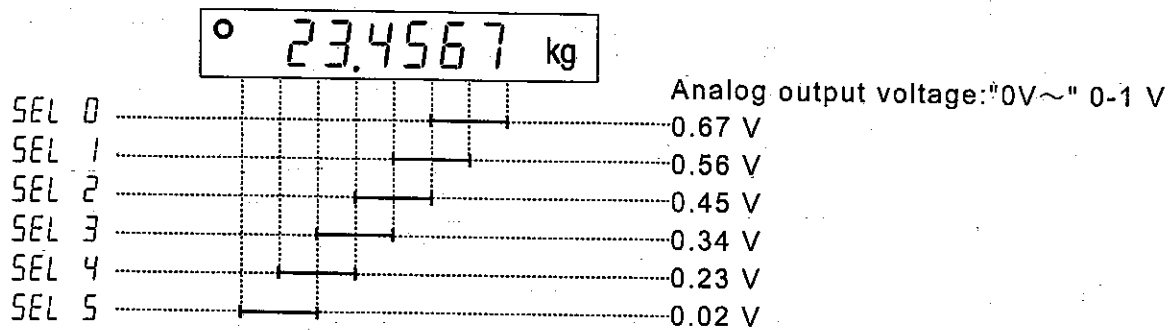

Notes

The invisible high-order digits are regarded as zero.

The invisible least digit is regarded as zero (when the minimum weighing value is turned off using the **SAMPEL** key).

When $R_n 1$ is set:

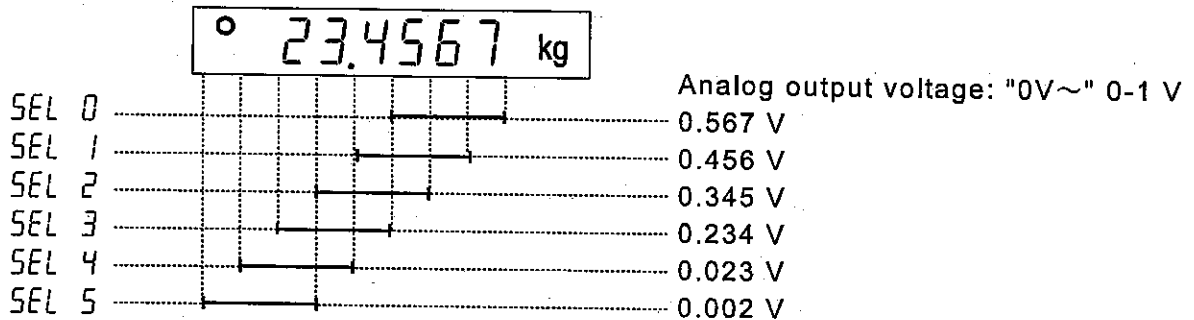

When $R_n 2$ or $R_n 3$ is set:

Model	Full scale
GP-12K	12 kg
GP-20K	20 kg
GP-22K	20 kg
GP-30K/30KS	30 kg
GP-40K	40 kg
GP-60K	60 kg
GP-100K/100KS	100 kg
GP-102K	100 kg

For example, when the GP-20K displays 2 kg, the output voltage of $R_n 2$ is 0.1 V (when the slide switch is set to "0V~").

$$1.000 \text{ V} \times \frac{2 \text{ kg}}{20 \text{ kg}} = 0.100 \text{ V}$$

Note

"Full scale" of the full scale output mode indicates the full scale values shown in the table above. The output voltage may exceed 1.000 V, depending on the weighing data.

For example, when the GP-20K displays 21 kg, the output voltage is 1.05 V.

$$1.000 \text{ V} \times \frac{21 \text{ kg}}{20 \text{ kg}} = 1.05 \text{ V}$$

5-4 Switching Output Voltage

The output voltage can be switched using the slide switch on the GP-06 panel. "0V~" has been set at factory before shipment.

"0V~" (0-1 V):	At zero	0.000 V	At full scale	1.000 V
"0.2V~" (0.2-1 V):	At zero	0.200 V	At full scale	1.000 V

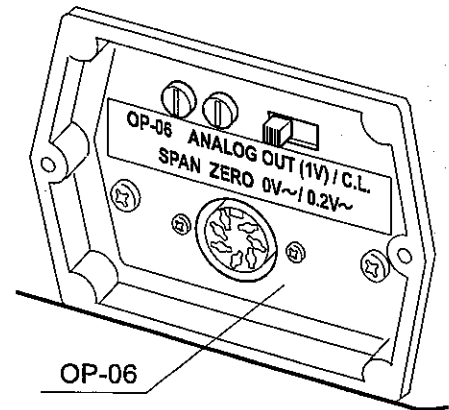

5-5 Output Voltage Fine Adjustment

The output voltage has been adjusted at the factory before shipment.

Using the ZERO and SPAN fine-adjustment knobs and a voltmeter, output voltage can be fine adjusted.

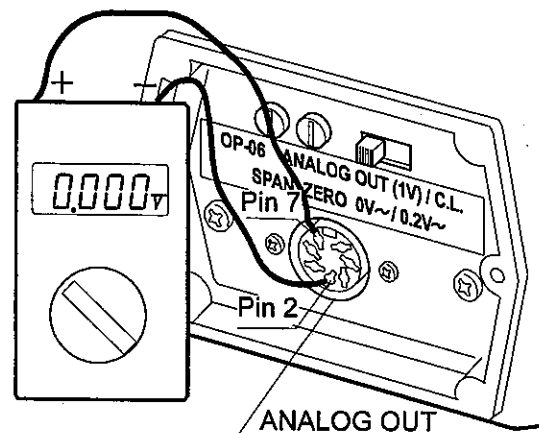

Fine-adjustment procedure

1. Turn the display off, using the **ON:OFF** key. At this time, the output voltage will be at zero. Turn the ZERO knob so that the voltmeter indicates 0.000 V when the slide switch is set to "0V~"; 0.200 V when the slide switch is set to "0.2V~".
2. While pressing and holding the **SAMPLE** and **PRINT** keys, press the **ON:OFF** key. The balance displays **P5**. At this time, a voltage of 1 V is generated. Turn the SPAN knob so that the voltmeter indicates 1.000 V.
3. Repeat steps 1 and 2 until the correct output voltage is obtained.

Display for setting the output to 0 V (0.2 V)



Display for setting the output to 1 V



5-6 Fixed Output Voltage

The output voltage is fixed under the following conditions:

1. During operations other than weighing (e.g., the display-off state, calibration) :0 V (or 0.2 V)
2. During the zeroing operation / $R_n \exists$:The previous output value is retained.
 $R_n 0 / R_n 1 / R_n 2$:0 V (or 0.2 V when the slide switch set to "0.2V~")
3. When "-E" (Weighing pan error) is being displayed: :0 V (or 0.2 V when the slide switch set to "0.2V~")
4. When "E" (Overload error) is being displayed: :Output voltage is as shown below.
 (when the slide switch is set to "0V~")

Model	$R_n 2, R_n 3$
GP-12K	1.000 V
GP-20K	1.050 V
GP-22K	1.050 V
GP-30K/30KS	1.033 V
GP-40K	1.025 V
GP-60K	1.018 V
GP-100K/100KS	1.010 V
GP-102K	1.010 V

