



**Ohaus Corporation**

29 Hanover Road

Florham Park, NJ

07932-0900

# Operating Instructions

## Ranger Scale

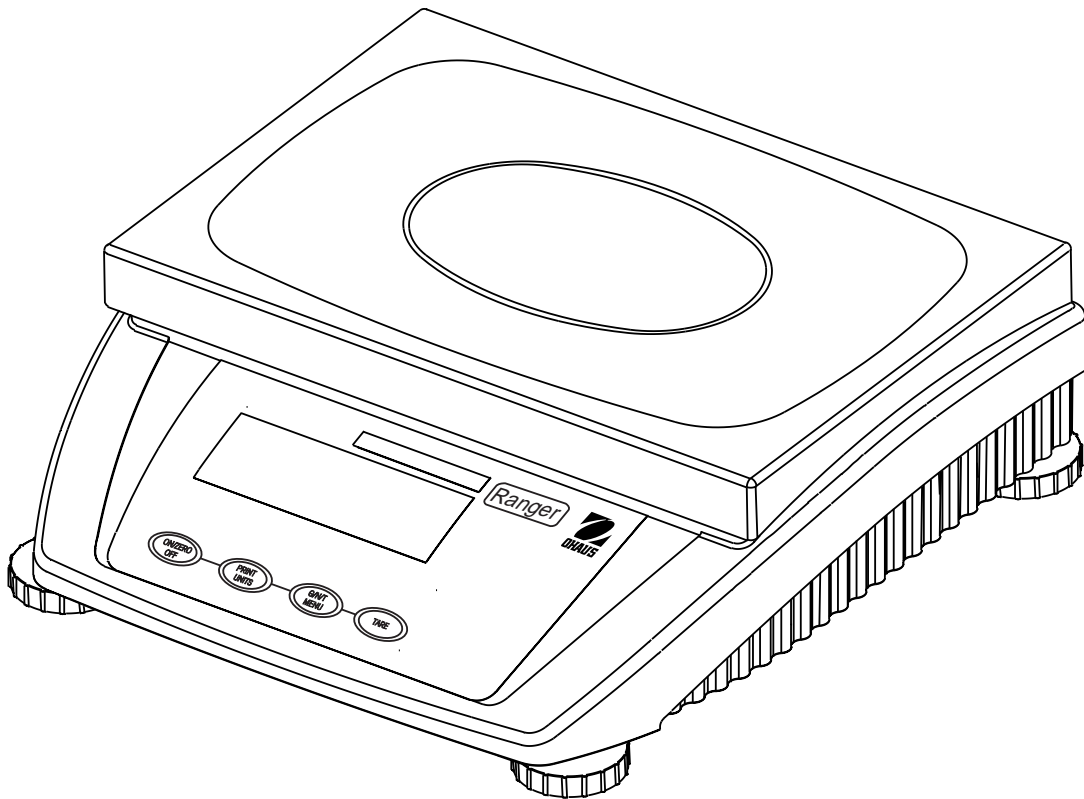

**Declaration of Conformity** We, Ohaus Corporation, declare under our sole responsibility that the balance models listed below marked with "CE" - are in conformity with the directives and standards mentioned.



**Konformitätserklärung** Wir, die Ohaus Corporation, erklären in alleiniger Verantwortung, dass die untenstehenden Waagentypen, gekennzeichnet mit "CE" - mit den genannten Richtlinien und Normen übereinstimmen.

**Déclaration de conformité** Nous, Ohaus Corporation, déclarons sous notre seule responsabilité, que les types de balance ci-dessous cités - munis de la mention «CE» - sont conformes aux directives et aux normes mentionnées ci-après.

**Declaración de Conformidad** Nosotros, Ohaus Corporation, declaramos bajo responsabilidad exclusiva que los modelos de balanzas indicados a continuación - con el distintivo 'CE' - están conformes con las directivas y normas citadas.

**Dichiarazione di conformità** Noi, Ohaus Corporation, U.S.A, dichiariamo sotto nostra unica responsabilità, che i tipi di bilance specificati di seguito - contrassegnati con la marcatura "CE" - sono conformi alle direttive e norme citate.

Balance Type/Waagentyp/Type de balance/Tipo de balanza/Tipo di bilancia **Ranger Scale**

Marked with: gekennzeichnet mit: munis de la mention: con el distintivo: contrassegnati con la marcatuara:	Directive Richtlinie Directive Directiva Direttiva	Standard Norm Norme Norma Norma
Year of attachment of the CE mark Jahr der ersten Eichung Année de la première vérification Año de la primera verificación annodella prima verifica	 EU 73/23/EEC Low Voltage EU 73/23/EEC Niederspannung EU 73/23/EEC Basse tension EU 73/23/EEC Baja tensión EU 73/23/EEC Bassa tensione	EN61010-1:1993 + A2: 1995 Safety Regulations EN61010-1:1993 + A2: 1995 Sicherheitsbestimmungen EN61010-1:1993 + A2: 1995 Consignes de sécurité EN61010-1:1993 + A2: 1995 Disposiciones sobre seguridad EN61010-1:1993 + A2: 1995 Prescrizioni di sicurezza
	 EU 89/336/EEC Electromagnetic compatibility EU 89/336/EEC elektromagnetische Verträglichkeit EU 89/336/EEC Compatibilité électromagnétique EU 89/336/EEC Compatibilidad electromagnética EU 89/336/EEC Compatibilità elettromagnetica	EN55011: 1991 (class B) Emissions; EN61000-3-2 EN50082-2:1995 Immunity; EN61000-3-3 EN55011: 1991 (class B) Funkstörungen; EN61000-3-2 EN50082-2:1995 Immunität; EN61000-3-3 EN55011: 1991 (class B) Emissions parasites; EN61000-3-2 EN50082-2:1995 Immunité; EN61000-3-3 EN55011: 1991 (class B) Radiointerferencias; EN61000-3-2 EN50082-2:1995 Inmunidad; EN61000-3-3 EN55011: 1991 (class B) Radiointerferenze; EN61000-3-2 EN50082-2:1995 Immunità; EN61000-3-3
 1) applies only to certified balances/scale	1) EU 90/384 NAWI EU 90/384 FNSW EU 90/384 BFNA EU 90/384 PBNA EU 90/384 BFNA	1) EN45501:1992 Non Automatic Weighing Instruments EN45501:1992 Für nicht selbsttätige Waagen EN45501:1992 Balances à fonctionnement non automatique EN45501:1992 Para balanzas no automáticas EN45501:1992 Per bilance a funzionamento non automatics

**ISO 9001 Registration for Ohaus Corporation.** Ohaus Corporation, USA, was examined and evaluated in 1994 by the Bureau Veritas Quality International, BVQI, and was awarded ISO 9001 registration. This certifies that Ohaus Corporation, USA, has a quality system that conforms with the international standards for quality management and quality assurance (ISO 9000 series). Repeat audits are carried out by BVQI at intervals to check that the quality system is operated in the proper manner.

**ISO 9001-Zertifikat für Ohaus Corporation.** Die Firma Ohaus Corporation, USA, wurde 1994 durch das Bureau Veritas Quality International BVQI geprüft, und erhielt das ISO 9001 Zertifikat. Dieses bescheinigt, dass Ohaus Corporation, USA über ein Qualitätssystem verfügt, welches den internationalen Normen für Qualitätsmanagement und Qualitätssicherung (ISO 9000er-Reihe) entspricht. Anlässlich von Wiederhol-Audits durch das BVQI wird periodisch überprüft, ob das Qualitätssystem zweckmässig gehandhabt wird.

**Certificat ISO 9001 pour Ohaus Corporation.** La société Ohaus Corporation, USA, a été contrôlée en 1994 par Bureau Veritas Quality International BVQI et a obtenu le certificat, degré ISO 9001. Celui-ci atteste que Ohaus Corporation, USA, dispose d'un système qualité correspondant aux normes internationales pour la gestion de la qualité et pour l'assurance qualité (degré ISO 9000). Des audits réguliers effectués par la BVQI vérifient si le système qualité est appliqué de façon appropriée.

**Certificado ISO 9001 para Ohaus Corporation.** La firma Ohaus Corporation, USA, ha sido inspeccionada por la Bureau Veritas Quality International (BVQI) y ha obtenido el certificado ISO 9001. Esto acredita que Ohaus Corporation, USA, dispone de un sistema de calidad que cumple las normas internacionales para gestión y garantía de calidad (ISO serie 9000). Con ocasión de las inspecciones de repetibilidad por parte de la BVQI, se comprueba periódicamente si el sistema de calidad se manipula de forma correcta.

**Certificato ISO 9001 per la Ohaus Corporation.** Il sistema di garanzia della qualità della Società Ohaus Corporation, USA è certificato ISO 9001 sin dal 1994 dal Bureau Veritas Quality International BVQI, e così fornisce la dimostrazione che il suo sistema di Garanzia Qualità soddisfa i massimi requisiti. Verifiche periodiche del BVQI garantiscono che il sistema qualità opera correttamente.

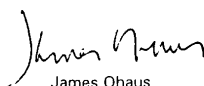
  
James Ohaus  
President

NOTE: THIS EQUIPMENT HAS BEEN TESTED AND FOUND TO COMPLY WITH THE LIMITS FOR A CLASS A DIGITAL DEVICE, PURSUANT TO PART 15 OF THE FCC RULES.

THESE LIMITS ARE DESIGNED TO PROVIDE REASONABLE PROTECTION AGAINST HARMFUL INTERFERENCE WHEN THE EQUIPMENT IS OPERATED IN A COMMERCIAL ENVIRONMENT. THIS EQUIPMENT GENERATES, USES, AND CAN RADIATE RADIO FREQUENCY ENERGY AND, IF NOT INSTALLED AND USED IN ACCORDANCE WITH THE INSTRUCTION MANUAL, MAY CAUSE HARMFUL INTERFERENCE TO RADIO COMMUNICATIONS. OPERATION OF THIS EQUIPMENT IN A RESIDENTIAL AREA IS LIKELY TO CAUSE HARMFUL INTERFERENCE IN WHICH CASE THE USER WILL BE REQUIRED TO CORRECT THE INTERFERENCE AT HIS OWN EXPENSE.

THIS DIGITAL APPARATUS DOES NOT EXCEED THE CLASS A LIMITS FOR RADIO NOISE EMISSIONS FROM DIGITAL APPARATUS AS SET OUT IN THE INTERFERENCE-CAUSING EQUIPMENT STANDARD ENTITLED "DIGITAL APPARATUS", ICES-003 OF THE DEPARTMENT OF COMMUNICATIONS.

CET APPAREIL NUMERIQUE RESPECTE LES LIMITES DE BRUITS RADIOELECTRIQUES APPLICABLES AUX APPAREILS NUMERIQUES DE CLASSE A PRESCRITES DANS LA NORME SUR LE MATERIEL BROUILLEUR : "APPAREILS NUMERIQUES", NMB-003 EDICTEE PAR LE MINISTRE DES COMMUNICATIONS.

Unauthorized changes or modifications to this equipment are not permitted.

# Contents

	OVERVIEW OF CONTROLS .....	6
<b>1.</b>	<b>INTRODUCTION</b> .....	<b>7</b>
1.1	Introduction .....	7
1.2	Overview of the scale .....	7
<b>2.</b>	<b>INSTALLATION</b> .....	<b>8</b>
2.1	Unpacking and checking contents .....	8
2.2	Safety considerations .....	8
2.3	Locating and leveling the scale .....	9
2.4	Connecting power .....	9
2.5	Battery operation .....	10
2.6	Connecting communications .....	10
<b>3.</b>	<b>OPERATION</b> .....	<b>11</b>
3.1	Menu structure .....	11
3.2	Switch functions .....	13
3.3	Menu operation .....	13
3.4	Turning on the scale and zeroing .....	15
3.5	Basic weighing .....	15
3.6	Weighing with tare .....	15
3.7	Gross/Net/Tare recall operation .....	16
3.8	Unit switch operation .....	16
<b>4.</b>	<b>SETTING UP YOUR SCALE</b> .....	<b>17</b>
4.1	Overview .....	17
4.2	Setup menu .....	17
4.3	Read menu .....	18
4.4	RS232-1 / RS232-2 menus .....	19
4.5	Lockout menu .....	20
4.6	Quit menu .....	20
<b>5.</b>	<b>CALIBRATION AND SEALING</b> .....	<b>21</b>
5.1	Calibration masses .....	21

---

5.2	Calibration .....	22
5.3	Unlocking the menus .....	22
5.4	Weights and measures sealing .....	23
<b>6.</b>	<b>CARE AND MAINTENANCE .....</b>	<b>24</b>
6.1	Troubleshooting .....	24
6.2	RS232 Interface .....	25
6.3	Error codes list .....	27
6.4	Service information .....	27
6.5	Accessories .....	27
6.6	Specifications .....	28

# Overview of controls

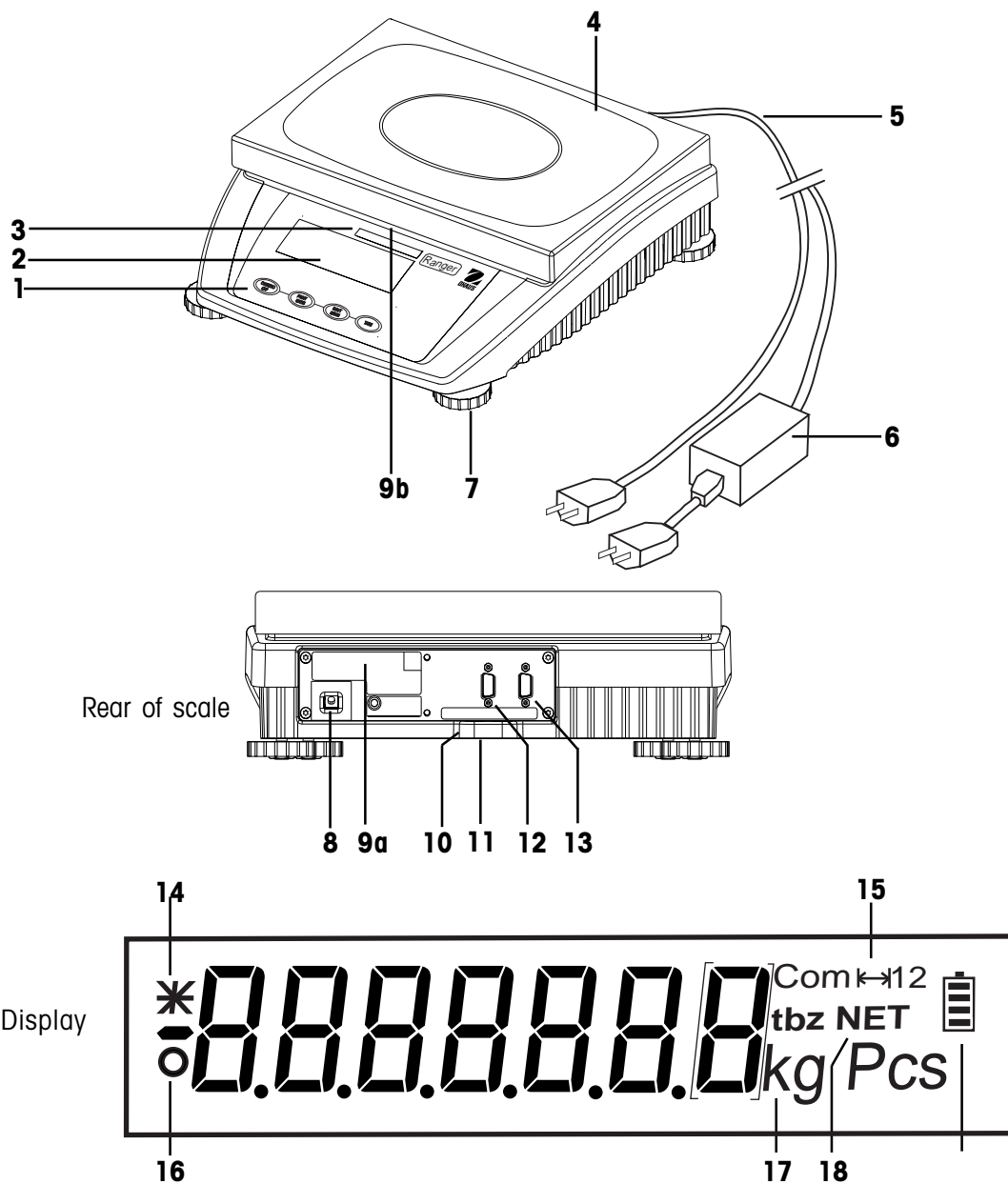

- |  |  |
|--|--|
| <b>1</b> Keypad  | <b>10</b> Hole for antitheft device                      |
| <b>2</b> Display                                       | <b>11</b> Spirit level                                   |
| <b>3</b> Capacity label                                | <b>12</b> RS232 Interface (Optional)                     |
| <b>4</b> Weighing pan                                  | <b>13</b> RS232 Interface (Standard)                     |
| <b>5</b> Power cord                                    | <b>14</b> Stability indicator                            |
| <b>6</b> AC Adapter (Scale with battery)               | <b>15</b> Weighing range display (for dual range scales) |
| <b>7</b> Adjustable feet                               | <b>16</b> Center of zero                                 |
| <b>8</b> Jack for AC Adapter (battery)                 | <b>17</b> weighing unit                                  |
| <b>9a</b> Serial # label (Europe)                      | <b>18</b> Net symbol when weighing with tare             |
| <b>9b</b> Serial # Label (USA) under weighing platform | <b>19</b> Battery discharge status (optional)            |

# Section 1 - Introduction

## 1.1 Introduction

Thank you for deciding to purchase a Ranger Scale from Ohaus. Behind your instrument stands OHAUS, a leading manufacturer of precision Scales, Moisture Analyzers, Balances, and Indicators. An Aftermarket Department with trained instrument technicians is dedicated to provide you with the fastest service possible in the event your instrument requires servicing. OHAUS also has a Customer Service Department to answer any inquiries regarding applications and accessories.

To ensure you make full use of the possibilities offered by your new Ranger Scale, please read the manual completely before installation and operation.

## 1.2 Overview of the scale

The Ranger Scale offers a high level of operating convenience and useful functions to make accurate measurements.

The Ranger Scale has the following features:

- Extremely rugged cast aluminum case and chemically resistant paint finish construction.
- Weighing pan constructed of stainless-steel.
- Fully programmable with front panel controls.
- Ergonomic operating controls and a large, easily readable display.
- Easy to follow menus for simplified operation.
- Lockout feature prevents inadvertent changing of menu settings.
- Back lighted display.
- Gross, Net, Tare operation.
- Selectable graduations.
- Auto zero operation.
- Auto tare operation.
- Built-in leveling feet and level indicator.
- Built-in functions for manual, automatic timing of printing intervals.
- Built-in RS232 communication interface (and optional additional channel ).
- Optional built-in battery operation .
- Up to 40 hours continuous operation with optional battery.
- Legal for trade operation.
- Calibration with either kg or lb.
- A variety of accessories includes interface communication cables, printer, and a security device.

# Section 2 - Installation

In this section, you will learn how you unpack and install your new Ranger Scale and prepare it for operation. On completion of the steps described in this section, your Scale is ready for operation.

## 2.1 Unpacking and checking contents

Open the package and remove the instrument and the accessories. Check the completeness of the delivery. The following accessories are part of the standard equipment of your new scale.

- 1 Removable power cable (supplied with battery operated scales)
- 1 Set of operating instructions
- 1 Warranty card

Remove packing material from the instrument.

Check the instrument for transport damage. Immediately inform your Ohaus dealer if you have complaints or parts are missing.

Store all parts of the packaging. This packaging guarantees the best possible protection for the transport of your instrument.

## 2.2 Safety considerations



Your scale employs state of the art technology and meets the latest demands regarding instrument safety. For safe and dependable operation, please comply with the following instructions:

- The Scale must not be operated in a hazardous environment and only under ambient conditions specified in these instructions.
- Only use approved accessories and peripherals.
- Do not tamper with the retaining screws for the load plate support underneath the weighing pan.
- It is not permitted to open the scale by removing screws in its base.
- The scale is a precision instrument, handle it carefully,





## 2.3 Locating and leveling the scale

The scale should always be used in an environment which is free from excessive air currents, corrosives, vibration, and temperature or humidity extremes. These factors will affect displayed weight readings.

**DO NOT** install the scale:

- Next to open windows or doors causing drafts or rapid temperature changes.
- Near air conditioning or heat vents.
- Near vibrating, rotating or reciprocating equipment.
- Near magnetic fields or equipment that generate magnetic fields.
- On an unlevel work surface.
- In confined areas, allow sufficient space around the instrument for ease of operation and keep away from radiating heat sources.
- Adjust the leveling feet so that the scale is exactly horizontal and the air bubble in the indicator is centered.

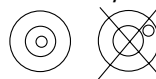

NOTE: The instrument should be leveled each time its location is changed.

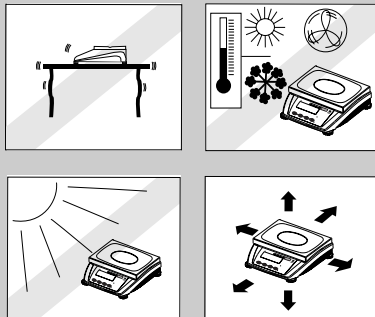

## 2.4 Connecting power

Check to ensure the voltage printed on the scale label matches your local line voltage. If this is not the case, **DO NOT** connect the scale to the power supply, but contact your responsible OHAUS dealer.

Connect the power cord from the scale to a suitable power source. If the scale is equipped with an optional internal battery, connect the AC cord supplied to the rear of the scale.

The scale now performs a self-test, displays the software version and the normal weight display then appears.

**Allow your scale to warm up for at least 30 minutes** to enable it to adapt itself to the ambient conditions. If the scale has been stored in a very cold environment before installation, it may require several hours to stabilize.

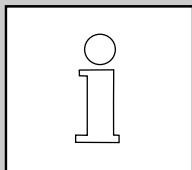
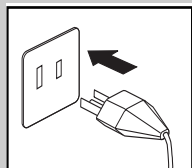
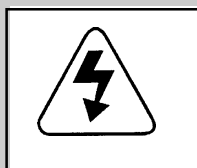

## 2.5 Battery operation

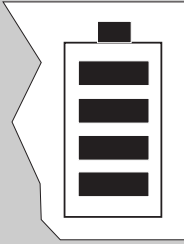

Scales with a built-in battery automatically switch to battery operation if there is a power failure or the power cord is removed. The battery symbol indicates the current discharge status of the battery (1 segment = 25% capacity). If the symbol flashes, the battery must be recharged.

A discharged battery requires at least 8 hours until it is recharged. During the charging process, work with the scale can continue, but under these conditions, a longer charging time is needed.

In normal use, the battery can operate the scale for up to 40 hours independent of the AC power line. The battery is protected against overcharging and the scale can remain connected to the AC power line.

## 2.6 Connecting communications

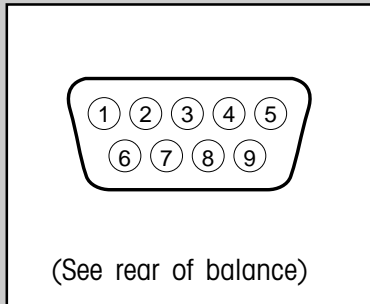
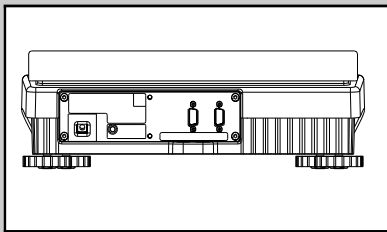

The scale is equipped with one bi-directional RS232 interface for communication with printers and computers. When the scale is connected directly to a printer, displayed data can be output at any time by simply pressing the **PRINT UNITS** button or by using one of the RS232 Mode print features. (A second optional RS232 interface is also available).

Connecting the scale to a computer or printer enables you to operate the scale from the computer, as well as receive data such as displayed weight, weighing mode, stability status, etc. and to have a permanent printed record.

On the rear of the scale, a 9-pin male subminiature "D" connector is provided for interfacing to other devices. Table below indicates pin connections.

1	
2	Data Out (TXD)
3	Data In (RXD)
4	
5	GND
6	
7	
8	
9	

See Accessories listed in paragraph 6.5. Connect a suitable cable from the scale to the external device.

Review paragraph 6.2, RS232 Interface for additional information regarding formats and command table.

# Section 3 - Operation

## 3.1 Menu structure

The following table illustrates the first three menu's in the Ranger Scale. The Main Menu contains 7 sub menus. The remaining menus appear on the next page.

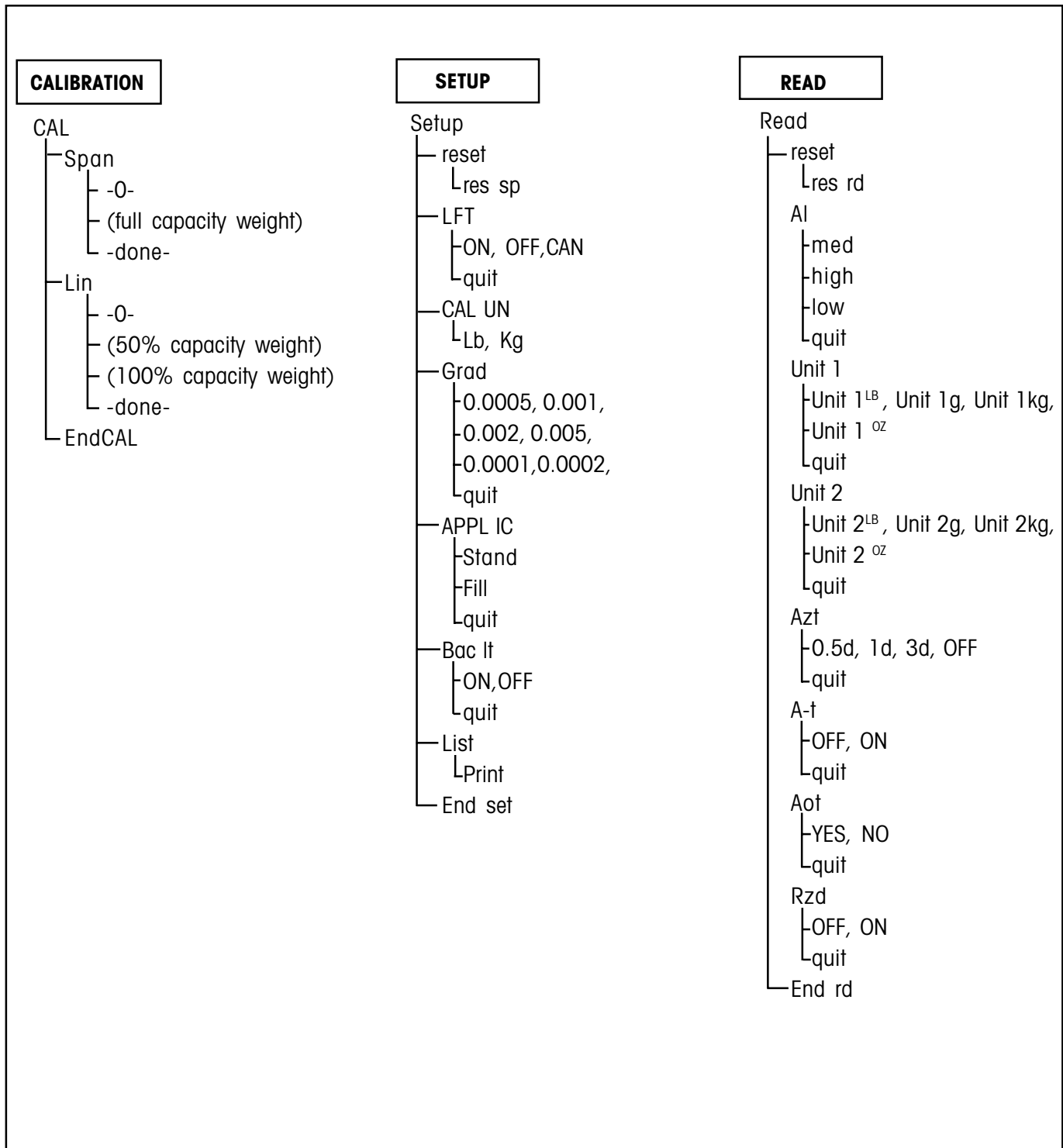

## 3.1 Menu structure

### RS232-1

rs232-1 Com 1

- reset
  - └reset rs
- Mode
  - └Print, On Stb, Stbonly, Cont, Disp 2
  - └quit
- baud
  - └300,600,1200, 2400, 4800, 9600, 19200,
  - └quit
- Parity
  - └7 even, 7 no p,
  - └8 no p, 7 odd
  - └quit
- Stop
  - └1, 2
  - └quit
- Handsh
  - └YES, NO
  - └quit
- Defstr
  - └Header
    - └ON, OFF
  - └Gross
    - └ON, OFF
  - └Net
    - └ON, OFF
  - └Tare
    - └ON, OFF
  - └4 L INF
    - └ON, OFF
  - └F Feed
    - └ON, OFF
  - └LN For
    - └Single, multi,
- └End rs1

### RS232-2

rs232-2 Com 2

- reset
  - └reset rs
- Mode
  - └Print, On Stb, Stbonly, Cont, Disp 2
  - └quit
- baud
  - └300,600,1200, 2400, 4800, 9600, 19200,
  - └quit
- Parity
  - └7 even, 7 no p,
  - └8 no p, 7 odd
  - └quit
- Stop
  - └1, 2
  - └quit
- Handsh
  - └YES, NO
  - └quit
- Defstr
  - └Header
    - └ON, OFF
  - └Gross
    - └ON, OFF
  - └Net
    - └ON, OFF
  - └Tare
    - └ON, OFF
  - └4 L INF
    - └ON, OFF
  - └F Feed
    - └ON, OFF
  - └LN For
    - └Single, multi,
- └End rs1

### LOCKOUT

Loc

- Cal
  - └ON, OFF
  - └quit
- Setup
  - └ON, OFF
  - └quit
- Read
  - └ON, OFF
  - └quit
- RS232-1
  - └ON, OFF
  - └quit
- RS232-2
  - └ON, OFF
  - └quit
- Locset
  - └ON, OFF
  - └quit
- Endloc
  - └quit

### QUIT

Quit

- └Store ?

## 3.2 Switch functions

The button switches located on the front panel of the scale provide several functions. Please read the following information before pressing any of these buttons.



BUTTONS	PRIMARY FUNCTION	SECONDARY FUNCTION
<b>ON/ZERO OFF</b>	Short press - Turns scale <b>ON</b> if OFF. Long press - Turns scale <b>OFF</b> if ON.	When scale is ON, short press <b>zeros</b> the scale.
<b>PRINT UNITS</b>	Short press - Sends <b>PRINT</b> command. Long press - Changes <b>UNITS</b> .	When in MENU MODE: short press = <b>NO</b> .
<b>G/N/T MENU</b>	Short presses - <b>Gross/Net/Tare</b> . No action for 5 secs., scale returns <b>NET</b> . Long press - Enter <b>MENU</b> .	When in MENU MODE: short press = <b>YES</b> .
<b>TARE</b>	Short press - enter <b>TARE</b> .	

## 3.3 Menu operation

In this section, you will learn how to work with the menu. The menu allows you to match your scale to your specific weighing needs. In the menu, you can change the settings of your scale and activate functions. The Main Menu contains 7 sub menus. Each of the seven sub menus are described in detail in the following sections.

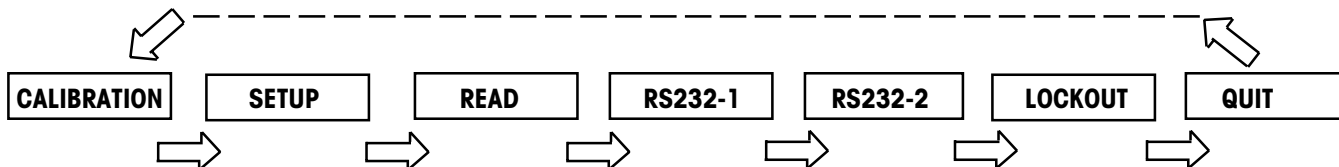

### How to enter the menus



(Long press)

To enter the menus, press and hold the **G/N/T MENU** button until CAL appears. This is the first menu, CALIBRATION.

### How to select a specific menu

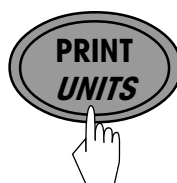

(Short press= NO)

A short press on the **PRINT UNITS** button = **NO**. When in MENU MODE short presses will advance to the next menu as shown below. When QUIT is reached, the next press on the **PRINT UNITS** button will return to the CALIBRATION menu.

## How to enter an individual menu



(Short press=YES)

A short press on the **G/N/T MENU** button = **YES** and you can enter a specific menu.

## How to enter an individual menu item

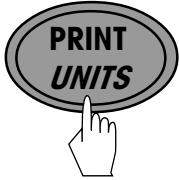

When in any menu, a short press on the **G/N/T MENU** button = **YES** and you can enter a specific menu item. To advance through a given menu, make short presses on the **PRINT UNITS =NO** button.

## How to save and store an individual menu item

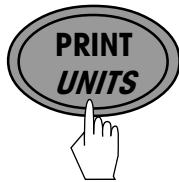

When a menu item has been changed once the desired selection is shown, make a short press on **G/N/T MENU** button, Quit appears on the display. If NO is selected by pressing the **PRINT UNITS** button, the next menu item appears. If yes is selected by pressing **G/N/T MENU**, StorE? appears. Pressing the **G/N/T MENU** button will store the change and return the scale to a weighing mode. If NO is selected, the menu change is ignored and scale returns to weighing mode.

## How to quit the menus

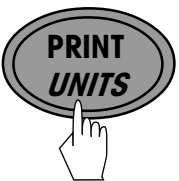

A short press on the **PRINT UNITS** button = **NO**. When in MENU MODE, short presses will advance through the menus until QUIT is reached. To quit, make a short press on the **G/N/T MENU** button, StorE? appears, answer YES to save and scale returns to a weighing mode, or NO to ignore changes and continue.

### 3.4 Turning on the scale and zeroing



Briefly press the **ON/ZERO OFF** button to turn the scale ON. The scale performs a display test routine and then is ready for weighing.

Briefly press the **ON/ZERO OFF** button again to zero the display. When '0' is displayed in the lower left of the display, the scale is at the center of zero.

### 3.5 Basic weighing

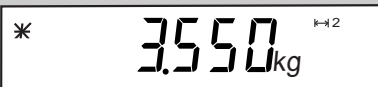
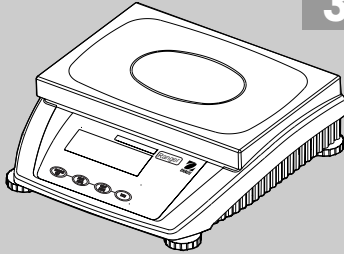

Place the object to be weighed on the scale.

Wait until the stability indicator (an asterisk in the upper left corner of the display) appears, then read the indicated weight.

### 3.6 Weighing with tare

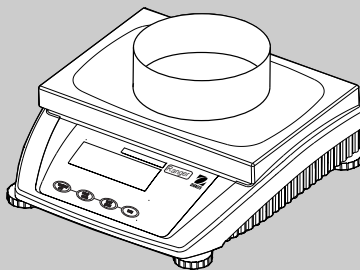

Place an empty weighing container or packaging on the scale.

Press the **TARE** button briefly to tare the scale. The zero display and NET (net weight) symbol appear. Items to be weighed can now be placed on the platform. The weight of the tared item (container) is automatically subtracted and the weight of the item is displayed. If the container is also removed, the scale will indicate a negative number which represented the tared weight. To clear this, press the **TARE** button.

**NOTE:** If the AUTO TARE function (A-t) has been activated in the READ menu, there is no need to press the **TARE** button

### 3.7 Gross/Net/Tare recall operation



When a container has been placed on the scale and tared, it's weight is stored in memory. Adding material to the container is shown as NET weight. The gross weight is a combination of the tared weight and the material. The **G/N/T Menu** button allows switching between GROSS, NET and TARE weights.

Repeatedly press (short presses) the **G/N/T Menu** button to cycle through Gross, Tare and Net readings. The sample illustrations indicate a tare weight of 0.02kg simulating a container, a net weight of 1.000kg which would be the material in a container and a gross weight of 1.020kg which is the total weight of the container and material. After 5 seconds, display returns to net weighing.

NOTE: The display uses symbols for NET and Tare. NET=NET, T=Tare. Gross=no symbol.

### 3.8 Unit switch operation

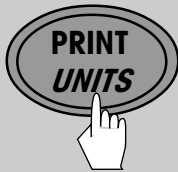

When the Read menu Unit 1 and Unit 2 have been set to either g, kg, oz or lb, you may press and hold the **PRINT UNITS** button to select one of the preset units. See Read Menu for selecting units.



# Section 4 - Setting up your scale

## 4.1 Overview

In this section, each of the menus are described as to the settings and application in the scale. Using the buttons previously described, you can configure your scale to specific weighing needs. The menus, allow you to change the settings and activate functions. Calibration menu is covered separately in Section 5.

## 4.2 Setup menu

SETUP







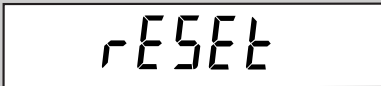

The Setup menu contains entries for LFT, calibration units, graduations, processing, back light, list and end set. See table below for details. Bold equals factory default settings.

Function/Display	Available Settings	Application
Reset rESEt	res sp	Press G/N/T <i>MENU</i> =reset and keep factory settings. Press PRINT <i>UNITS</i> =NO, advances to next menu.
Legal for trade LFT	<b>Off</b> On CAN	Legal for trade applications when set ON or CAN.
Calibration unit CAL Un	Kg, lb	Calibration may be set using either kg or lb.
Graduation GrAd	0.001, 0.002, 0.005, 0.0001, 0.0002, 0.0005	This is the graduation size and available options vary with the capacity of the scale.
Application APPL IC	<b>Stand</b> -Standard FILL-Filling	Regular weighing. Dispensing for filling applications.
Back Light bAC Lt	<b>On</b> Off	Back light can turned on or off.
List L iSt	Print	Allows printing of complete setup menu.
End Settings End SET	End of setup menu.	End of setup menu, when selected by pressing G/N/T <i>MENU</i> button, display advances to READ MENU.

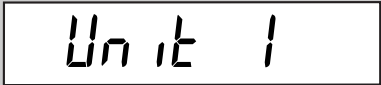
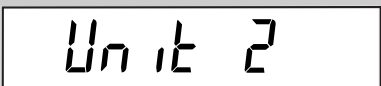
## 4.3 Read menu

rEAd

The Read menu contains entries for reset, average level, unit 1, unit 2, auto zero, auto tare, auto power off, retain zero data and end. See table below for details. Bold equals factory default settings.

Function/Display	Available Settings	Application
Reset 	reset rd	Press G/N/T <i>MENU</i> =reset and keep factory settings. Press PRINT <i>UNITS</i> =NO, advances to next menu.
Averaging level 	Low, <b>Med</b> , High	Averaging level. High=greater stability, Med=mid stability, Low=less stability, faster processing time.
Unit 1 	g, kg, oz, lb	This is the first weighing unit.
Unit 2 	g, kg, oz, lb	This is the alternate weighing unit.
Auto-Zero Tracking 	<b>0.5d</b> , 1d, 3d, Off	Settings minimize temperature and small disturbances on the zero reading.
Auto Tare 	On <b>Off</b>	Enables automatic tare when set to ON.
Auto Power Off 	Yes <b>No</b>	When set ON, power is removed after 5 minutes if battery pack is present and power cord is not plugged in.
Retain Zero Data 	On <b>Off</b>	Retains stored zero point when scale is turned off.
End Read Settings 	End of read menu.	End of Read menu, when selected, display advances to RS232-1 menu.

## 4.4 RS232-1 / RS232-2 menus

rs232-1<sup>Com 1</sup>





The RS232-1 menu provides the communication settings to port 1 (standard). RS232-2 is Port 2 which is an option and has exactly the same settings. Bold equals factory default settings.

Function/Display	Available Settings	Application
Reset 	res rs	Press G/N/T <i>MENU</i> =reset and keep factory settings. Press PRINT <i>UNITS</i> =NO, advances to next menu.
Mode 	<b>Print</b> , cont, on stb, stbonly, dialog, disp 2	Selects mode of operation for RS232. Print, print on stability, continuous, dialog (interface). Print stable only and remote display.
Baud Rate 	300, 600, 1200, <b>2400</b> , 4800, 9600, 19200	Various baud rates are available to match external equipment communication requirements.
Parity 	7 Even, <b>7 No P</b> , 8 No P, 7 Odd	Various parity settings are available to accommodate external equipment requirements.
Stop 	1 <b>2</b>	Two stop settings (1 or 2) are available to accommodate external equipment requirements.
Handshake 	<b>Yes</b> No	Software communication.
Default String 	Header, Gross, Net, Tare, 4 L in f, F feed, LN for, Mode	Determines what is printed via print command. Selects a string of data to be printed; header, gross, net, tare, 4 line feed, form feed, multi or single line.
End Settings 	End of RS232 menu.	End of RS232-1 menu, when selected, display advances to RS232-2 menu.

## 4.5 Lockout menu

LOC

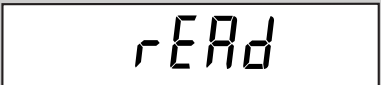
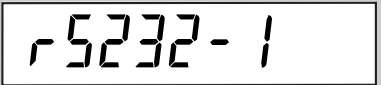
This menu allows software locking and unlocking the calibration, setup, read, RS232-1, RS232-2, menus. Locking is done to limit menu access or for LFT applications. Once LocSet is set to ON, the menu can only be unlocked by a switch on the circuit board of the scale.

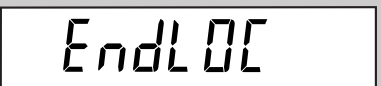
Function/Display	Available Settings	Application
Calibration 	On <b>Off</b>	An ON setting locks out the calibration menu.
Setup 	On <b>Off</b>	An ON setting locks out the setup menu.
Read 	On <b>Off</b>	An ON setting locks out the read menu.
RS232-1 	On <b>Off</b>	An ON setting locks out the RS232-1 menu.
RS232-2 	On <b>Off</b>	An ON setting locks out the RS232-2 menu.
Lockset 	On <b>Off</b>	When set on, locks all software settings in this menu.
Endlock 		End of lock menu when selected, advances to CAL menu.

## 4.6 Quit menu

Quit

Quit

End of menus. Store? - Yes, will go to a weighing mode, No, returns to Calibration menu.

# Section 5 - Calibration and sealing

---

Ranger scales offer a choice of two calibration methods: Span Calibration, and Linearity Calibration.

**Span** - Span calibration ensures that the scale reads within specifications using two weight values: zero and a weight value close to 100% of the full capacity. Special software features enable you to span calibrate at a number of lesser values which varies with the model of the scale.

**Linearity** - Linearity calibration minimizes deviation between actual and displayed weights within the scale's weighing range. Three weight values are used: zero, a weight value at midpoint of the scale's weighing range, and a weight value at or near the specified capacity.

For best results, calibrate at or near full capacity. Calibration unit can be set to either kg or lb. *When the scale is used in Legal for trade applications, the calibration menu is locked out and is not accessible.* This is to prevent unauthorized personnel from changing calibration. Before beginning calibration, make sure masses are available. If you begin calibration and realize calibration masses are not available, exit the menu with a short press of the **ON/ZERO OFF** button. The scale will retain previously stored calibration data. Calibration should be performed as necessary to ensure accurate weighing. Masses required to perform the procedures should be in compliance with the specification requirements of the scale being used.

## 5.1 Calibration masses

Before beginning calibration, make sure masses are available. If you begin calibration and realize calibration masses are not available, exit the menu. The scale will retain previously stored calibration data. Calibration should be performed as necessary to ensure accurate weighing.

## 5.2 Calibration

**CAL**

**SPAN**

**Lin**

**End CAL**

**NOTE:** If the scale is sealed and is used for legal for trade, the seal must be removed to gain access to the unlock switch located underneath the scale in order to calibrate the scale. Refer to paragraph 5.3.

Access the calibration menu SPAN is displayed. You have a choice of calibrating the scale using span or linearity methods. If you press the **PRINT UNITS** button, you can access linearity calibration. Span calibration requires two points zero and full span. Linearity requires three points zero, mid-range and full span.

Press **G/N/T Menu** button, -0- is displayed followed by mass value to be placed on the platform. For example, a 3kg scale would normally require 3kg for a span calibration. By pressing the **PRINT UNITS** button repeatedly, a lesser value mass can be used. For example, a 3kg scale offers 2kg, 1.5kg, 1.2kg, 1kg, 0.9kg, 0.8kg and 0.7kg for full span.

Place the indicated mass on the platform and press the **G/N/T MENU** button.

If the calibration was successful, the calibration mass value and DONE is displayed and the calibration data is saved automatically. Remove calibration masses from platform.

When performing a linearity calibration, -0- is first displayed followed by the first mass and then a second mass. As with span calibration, you are offered a choice of lesser weights to be used for calibration

## 5.3 Unlocking the menus

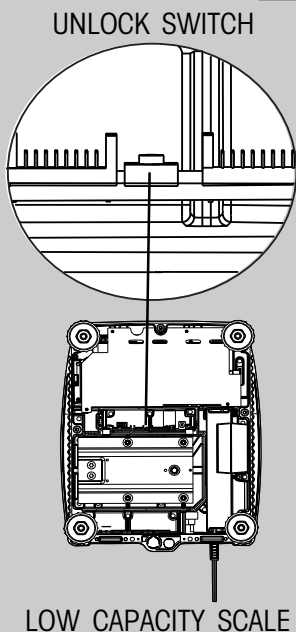

### Low Capacity Scale

If it necessary to recalibrate a scale which has been set up for legal for trade use, or if the Locset menu is ON, you will have to remove the seal at the bottom of the scale to gain access to the unlock switch.

To unlock the menus, **turn the scale off.**

On low capacity scales, remove the existing seal and four cover screws from the bottom of the scale. You will have to unscrew the feet to access the screws.

Position the scale so the bottom is accessible.

**NOTE:** Do the next step carefully.

First, press and hold the unlock switch then, briefly press the **ON/ZERO OFF** switch at the same time, release the unlock switch after the segment test is displayed. The menus are now unlocked and settings can be changed.

## 5.3 Unlocking the menus (Cont.)

UNLOCK SWITCH

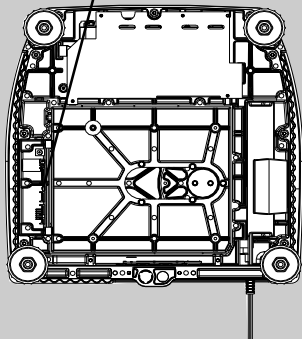
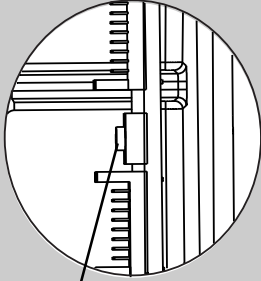

HIGH CAPACITY SCALE

### High Capacity Scale

On high capacity scales, remove the existing seal and six cover screws from the bottom of the scale. You will have to unscrew the feet to access the screws.

Position the scale so the bottom is accessible.

**NOTE:** Do the next step carefully.

First, press and hold the unlock switch then, briefly press the **ON/ZERO OFF** switch at the same time, release the unlock switch after the segment test is displayed. The menus are now unlocked and settings can be changed.

## 5.4 Weights and measures sealing

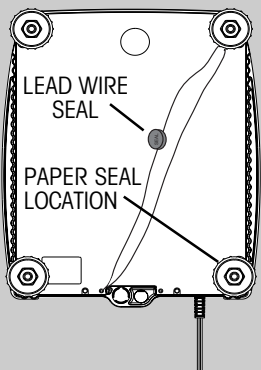

LOW CAPACITY SCALE

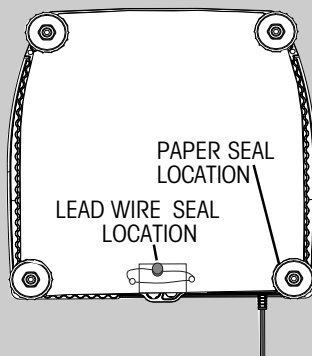

HIGH CAPACITY SCALE

After a weights and measures official has tested and approved the scale, it must be sealed by installing the security plate with the security screw.

Replace the bottom cover and secure with the cover screws.

### Paper Seal

A paper seal may be placed over one of the screws at the back of the scale underneath one foot.

Replace the four feet and turn the scale over.

### Lead Wire Seal

For regions requiring a lead wire seal, there are 2 cross drilled screws at the rear of the scale. The screws can be used in the location as supplied or as an alternate, one screw can be used to replace one of the counter-sunk screws at the front of the scale. (Under the leveling feet on small size Ranger Scales.)

# Section 6 - Care and maintenance

To keep the scale operating properly, the housing should be kept clean and free from foreign material. If necessary, a cloth dampened with a mild detergent may be used.

## 6.1 Troubleshooting

SYMPTOM	PROBABLE CAUSE(S)	REMEDY
Unit will not turn on.	Not plugged in or properly connected.  Battery operation -battery dead or not fully charged.  Membrane switch failure.	Check power cord connections.  Check battery, charge battery.  Check functions of membrane switch.
Cannot zero scale, or will not zero when turned on.	Load on scale exceeds allowable zero.	Remove load on scale to less than entered zero.
Center of Zero display erratic or does not appear with no load on platform.	Scale platform motion or disturbances exceed center of zero criteria.	Remove disturbances or reduce motion.  Increase AZT level in readout menu.  Increase averaging level in readout menu.
Cannot display weight in desired weighing unit.	Desired unit not set to ON in Setup menu.	Enable desired unit in Setup menu.  Conversion to large (typically in g).
RS232 not working.	RS232 communication parameters set up incorrectly.  Improper or loose cable connections.	Verify communication parameters.  Check cable connections.
Unable to calibrate unit.	Incorrect value for calibration mass.  Lockout menu CAL set to ON and unlock switch is on the circuit board.	Use correct calibration mass.  Unlock the switch and recalibrate the scale.



## 6.2 RS232 interface

Ranger Scales are equipped with one bi-directional RS232 compatible interface for communication with printers and computers. A second optional interface is available. When the scale is connected directly to a printer, displayed data can be output at any time by simply pressing **PRINT UNITS** button , or by using the Auto Print feature.

Connecting the scale to a computer enables you to operate the scale from the computer, as well as receive data such as displayed weight, weighing mode, stability status, etc.

The following sections describe the hardware and software provided with the balance

### RS232 Hardware

On the rear of the balance, the 9-pin male subminiature "D" connector is provided for interfacing to other devices. On scales equipped, a second RS232 connector is available.

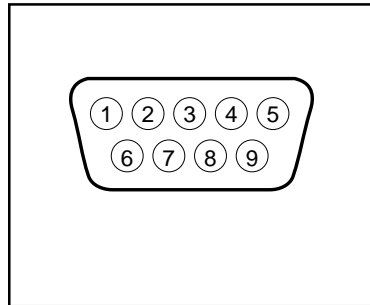

### Output formats

Data output can be initiated in one of three ways: 1) By pressing PRINT; 2) Using the Auto Print feature; 3) Sending a print command ("P") from a computer.

## RS232 commands

All communication is accomplished using standard ASCII format. Characters shown in the following table are acknowledged by the scale. Invalid command response "ES" error indicates the scale has not recognized the command. Commands sent to the scale must be terminated with a carriage return (CR) or carriage return-line line feed (CRLF). Data output by the scale is always terminated with a carriage return - line feed (CRLF). The output format is illustrated in the table which follows.

RS232 COMMAND TABLE

Command Character	Description
<b>OS</b>	Print weight (stable or unstable) after P cmd.
<b>1S</b>	Print stable weight after P cmd.
<b>SA</b>	Print on stability. *Send final stable weight value.
<b>CA</b>	Continuous Print. Prints weighing string w/o default string information.
<b>xxxxA</b>	Interval Print xxxx= Print Interval (1-3600 sec) (OA turns off print interval)
<b>P</b>	*Print display data (see OS and 1S)
<b>Z</b>	Same as pressing Zero button.
<b>T</b>	Same as pressing Tare button.
<b>C</b>	Begin span calibration
<b>L</b>	Begin linearity calibration.
<b>XT</b>	Download Tare value in grams. Uses unit set as Unit 1.
<b>SN</b>	Show serial number
<b>H 1 (1-5)</b>	1 to 5 headers are available with 24 characters per line; enter H space, then text. (See below)

## Creating header information

Ranger Scale contains provisions for entering a custom header using an external PC connected to the RS232 connector. The header can contain up to 5 lines with a maximum of 24 characters per line. This is very useful to identify printed reports.

Create the header as follows using the PC keyboard:

LINE # 1: H (space) 1 (space) "text 1st line", then press Enter on PC keyboard.  
 LINE # 2: H (space) 2 (space) "text 2nd line", then press Enter on PC keyboard.  
 LINE # 3: H (space) 3 (space) "text 3rd line", then press Enter on PC keyboard.  
 LINE # 4: H (space) 4 (space) "text 4th line", then press Enter on PC keyboard.  
 LINE # 5: H (space) 5 (space) "text 5th line", then press Enter on PC keyboard.

Deleting a header line:

Type: H (space) 1 (space) ` ` L<sub>no text</sub>

## Printing header without PC

1. Disconnect the PC. Connect to printer.
2. In the RS232 menu, set the RESET to YES and DEFSTR-HEADER to ON.
3. The header will print before each weighing data.

## 6.3 Error codes list

The following list describes the various error codes and which can appear on the display and the suggested remedy.

- Error 1:** Indicates an overload condition.
- Error 2:** Indicates an underload condition.
- Error 3:** Average piece weight too small.
- Error 4:** Reference weight too small. The weight on the pan is too small to define a valid reference weight for counting.
- Error 5:** No valid reading from reference scale. When parts counting with a two scale system, communications lost.
- Error 6:** Scale needs calibration.
- Error 9:** Unstable weight reading when defining the reference weight.
- Error 53:** EEPROM checksum error.
- :** Busy (tare, zero, printing).
- no--:** Function not executed.

## 6.4 Service information

If the Troubleshooting section does not resolve or describe your problem, you will need to contact an authorized Ohaus Service Agent. For Service assistance in the United States, please call Aftermarket, Ohaus Corporation toll-free at (800) 526-0659. An Ohaus Product Service Specialist will be available to help you.

## 6.5 Accessories

<u>Description</u>	<u>Ohaus Part No.</u>
Ranger RS232 Cable to Printer 25 Pin (800500526 cable with 25-9 pin adapter)	800500523
Ranger RS232 Cable to IBM PC 25 Pin (standard 9 pin serial extension cable with 9-25 pin adapter)	800500524
Ranger RS232 Cable to IBM 9 Pin (standard 9 pin serial extension cable)	800500525
Ranger RS232 Cable to Ranger - Dual Scale	800500526
Printer	AS142
Ranger In-Use Cover Small	<del>21208534</del>
Ranger In-Use Cover Large	<del>21208535</del>
Ranger Security Device	76288-01
Ranger Carrying Case Small	80850083
Ranger Carrying Case Large	80850084
Auxiliary Display	80850082

## 6.6 Specifications

<b>Standard Models —NTEP</b>		<b>RD3RS</b>	<b>RD6RS</b>	<b>RD12LS</b>	<b>RD30LS</b>	<b>RD60LS</b>
Default Capacity x Readability	(lb)	6 x 0.0005	12 x 0.001	24 x 0.002	60 x 0.005	120 x 0.01
Default Capacity x Readability	(kg)	3 x 0.0002	6 x 0.005	12 x 0.001	30 x 0.002	60 x 0.005
Default Capacity x Readability	(g)	3000 x 0.2	6000 x 0.5	12000 x 1	3000 x 2	60000 x 5
Default Capacity x Readability	(oz)	60 x 0.005	120 x 0.01	240 x 0.02	600 x 0.05	1200 x 0.1

NTEP Capacity x Readability	(lb)	6 x 0.001	12 x 0.002	24 x 0.005	60 x 0.01	120 x 0.02
NTEP Capacity x Readability	(kg)	3 x 0.0005	6 x 0.001	12 x 0.002	30 x 0.05	60 x 0.01
NTEP Capacity x Readability	(g)	3000 x 0.5	6000 x 1	12000 x 2	30000 x 5	60000 x 10
NTEP Capacity x Readability	(oz)	60 x 0.01	120 x 0.02	240 x 0.05	600 x 0.1	1200 x 0.2
Linearity	(g)	+/- 0.2	+/- 0.5	+/- 1.0	+/- 2.0	+/- 5.0
<b>Order number:</b>		<b>RD3RS-2E0</b>	<b>RD6RS-2E0</b>	<b>RD12LS-2E0</b>	<b>RD30LS-2E0</b>	<b>RD60LS-2E0</b>

### Ranger Options

1	BATTERY	To order Ranger with internal rechargeable battery, <b>add /1</b> to the order number above.
2	2nd RS232	To order Ranger with second RS232 data interface, <b>add /2</b> to the order number above.
3	BATTERY & 2nd RS232	To order Ranger with both an internal rechargeable battery and second RS232 data interface, <b>add /3</b> to the order number above.

### General Specifications

Platform size	(w x d) (in/cm)	9.5 x 8 / 24 x 20	14 x 9.5 / 35 x 24
Scale dimensions	(w x d x h) (in/cm)	10.5 x 13.2 x 4 / 26.5 x 33.5 x 10	14.2 x 14.6 x 4.5 / 36 x 37 x 11.5
Shipping dimensions	(w x d x h) (in/cm)	16.5 x 19 x 10 / 42 x 48 x 25	20 x 20.5 x 10.5 / 52 x 53 x 27
Weight	(lb/kg)	11.5 / net (14 / 6.5 gross)	21 / 9.5 net (24 / 11 gross)
Weighing units		g, kg, lb, oz	
Display		0.63 inch / 16 mm digit height, (Backlit LCD)	
Power		Internal power supply / 40 hour rechargeable battery powered models available	
Span Calibration		25% - 100% capacity	
Linearity Calibration ( 3 point calibration)		0 - 50% - 100% capacity	
Auto Zero Tracking		0.5d, 1d, 3d, OFF	
Construction		Stainless steel weighing pan / Painted cast-aluminum housing	
Protection		IP43	
Operating temperature		Standard models -10°C to 40°C	
Storage temperature		-20°C to 60°C	

## Ranger OIML Version

Models	3 kg		6 kg		15 kg		35 kg		60 kg	
WEIGHING RANGE	Range 1	Range 2	Range 1	Range 2	Range 1	Range 2	Range 1	Range 2	Range 1	Range 2
Default Cap. x Readability (kg)	1.5kg x 0.5g	3kg x 1g	3kg x 1g	6kg x 2g	6 x 0.002	15 x 0.005	15 x 0.005	35 x 0.01	30 x 0.01	60 x 0.02
Default Cap. x Readability (g)	1500 x 0.5	3000 x 1	3000 x 1	6000 x 2	6000 x 2	15000 x 5	15000 x 5	35000 x 10	30000 x 10	60000 x 20
Default Cap. x Readability (lb)	3 x 0.001	6 x 0.002	6 x 0.002	12 x 0.005	12 x 0.005	30 x 0.02	30 x 0.01	70 x 0.02	60 x 0.02	120 x 0.05
Default Cap. x Readability (oz)	30 x 0.02	60 x 0.02	60 x 0.02	120 x 0.05	120 x 0.05	300 x 0.02	300 x 0.2	700 x 0.2	600 x 0.2	1200 x 0.5

General Specifications	Small Platform	Large Platform
Platform size (w x d) (cm)	24 x 20	35 x 24
Scale dimensions (w x d x h) (cm)	26.5 x 33.5 x 10	36 x 37 x 11.5
Shipping dimensions (w x d x h)(cm)	42 x 48 x 25	52 x 53 x 27
Weight (kg)	5 net (6.5 gross)	9.5 net (11 gross)
Weighing units	g, kg, lb, oz	
Display	0.63 inch / 16 mm digit height, (Backlit LCD)	
Power	Internal power supply / 40 hour rechargeable battery powered models available	
Span Calibration	25% - 100% capacity	
Linearity Calibration ( 3 points)	0 – 50% - 100% capacity	
Auto Zero Tracking	0.5d, 1d, 3d, OFF	
Construction	Stainless steel weighing pan / Painted cast-aluminum housing	
Protection	IP43	
Operating temperature	Standard models -10°C to 40°C	
Storage temperature	-20°C to 60°C	

All Ranger models meets the requirements of Approval Agencies: UL, FCC, CSA, CE Safety EN60950, Emissions EN55022, Immunity EN50082-1.



# LIMITED WARRANTY

Ohaus products are warranted against defects in materials and workmanship from the date of delivery through the duration of the warranty period. During the warranty period Ohaus will repair, or, at its option, replace any component(s) that proves to be defective at no charge, provided that the product is returned, freight prepaid, to Ohaus.

This warranty does not apply if the product has been damaged by accident or misuse, exposed to radioactive or corrosive materials, has foreign material penetrating to the inside of the product, or as a result of service or modification by other than Ohaus. In lieu of a properly returned warranty registration card, the warranty period shall begin on the date of shipment to the authorized dealer. No other express or implied warranty is given by Ohaus Corporation. Ohaus Corporation shall not be liable for any consequential damages.

As warranty legislation differs from state to state and country to country, please contact Ohaus or your local Ohaus dealer for further details.







Ohaus Corporation  
29 Hanover Road,  
Florham Park, NJ 07932, USA  
Tel: (973) 377-9000,  
Fax: (973) 593-0359  
[www.ohaus.com](http://www.ohaus.com)

With offices worldwide.

P/N 21203624 © Ohaus Corporation 2000, all rights reserved.