

S2000 Jr. SERIES

Price Computing Scale

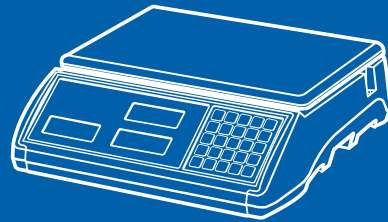

www.globalcas.com

OWNER'S MANUAL

CAS

CONTENTS

PRECAUTIONS	4
PREFACE	6
OVERALL VIEW	6
DISPLAY & KEYBOARD	7
OPERATIONS	11
I. Programming Mode	11
Chapter 1. Basic Operation.....	12
Chapter 2. PLU Saving & Calling-up.....	15
Chapter 3. User's Set-up Mode.....	19
Chapter 4. Formatting Printing Receipt.....	25
II. Sales Mode	32
Chapter 5. Sales Transaction.....	33
Chapter 6. Daily Total Sales.....	35
ASCII CODE	37
ERROR MESSAGES	38
SERIAL INTERFACE	38
SPECIFICATION	39

PRECAUTIONS

Warning

To ensure you get the most out of your scale, please adhere to these precautions during its installation and operation.

Do NOT disassemble the scale. For any defect or failure contact your CAS authorized dealer.

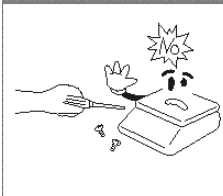

Do NOT exceed the maximum weight limit.

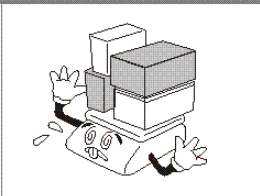

Scale must be grounded to minimize static electricity. This will also minimize the chance for electric shock and minimize defects.

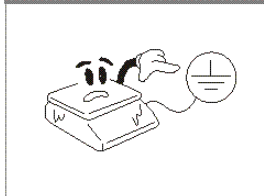

Do NOT pull the plug by its cord when unplugging. Damaged cord could cause electric shock or fire.

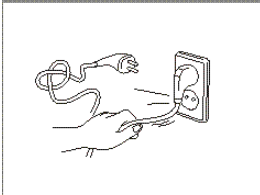

To prevent fire, do not place or use scale near flammable or corrosive gases.

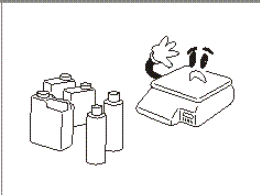

To reduce electric shock or inaccurate readings, do NOT spill water on the scale or place it in a humid location.

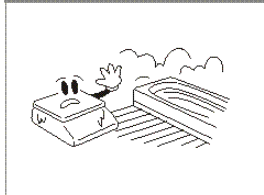

Avoid placing the scale near heaters or in direct sunlight.

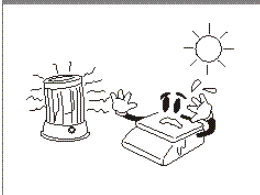

To prevent electric shock, insert the plug firmly into the wall outlet.

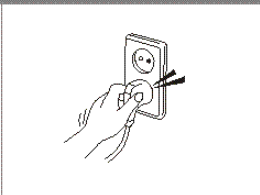

Use the proper Adapter. An Incorrect Adapter could damage the scale.

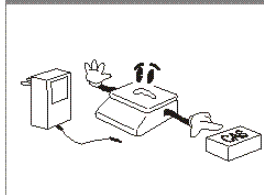

Attention

Make sure to plug your scale into the proper rated power outlet. For maximum performance, plug into a power outlet 30 minutes prior to usage to allow the scale to warm up.

For consistent and accurate reading, have your scale checked periodically by your CAS Authorized Dealer.

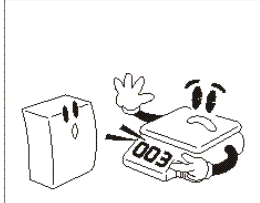

Avoid sudden shock to the scale.

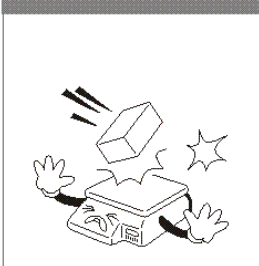

Grab on the bottom of the scale when moving.

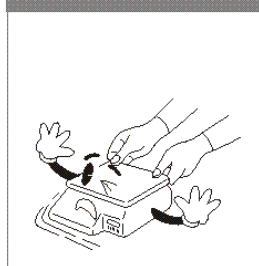

Keep the scale away from other electromagnetic generating devices. This may interfere with accurate reading.

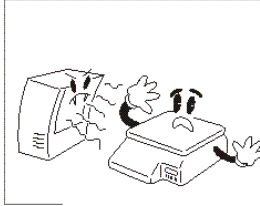

Place the scale on firm, stable platform and in a temperature consistent environment.



By adjusting 4 legs of the scale, make sure the scale is level. Use the built in scale leveling indicator.

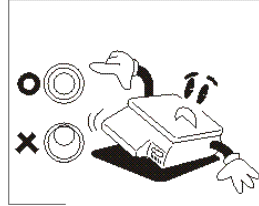

Remove the batteries when the scale is not used for a long time. Leakage from the batteries may be hazardous.

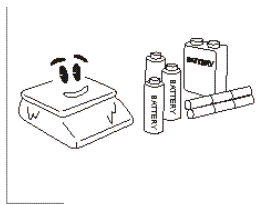

There is a risk of explosion if the batteries are replaced with an incorrect type. Dispose of batteries in accordance with local regulations.

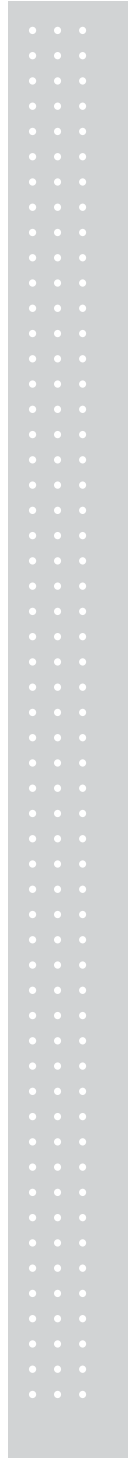
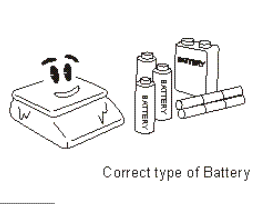

PREFACE

Thank you for purchasing the CAS S2000 Jr. This series has been designed with CAS reliability, under rigid quality control and with outstanding performance. Your specialty departments can enjoy this CAS product. We hope that this CAS product meets your needs. The user manual is designed to help you to understand the proper operation and care of the product.

OVERALL VIEW

■ S2000 Jr.

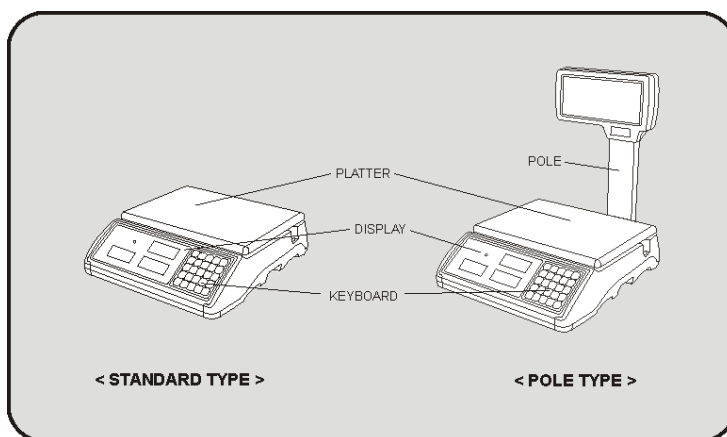

■ S2000 Jr - M

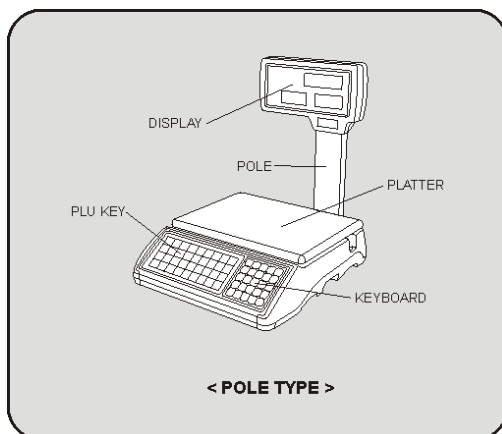

DISPLAY & KEYBOARD

■ S2000 Jr. LCD TYPE : Front Display

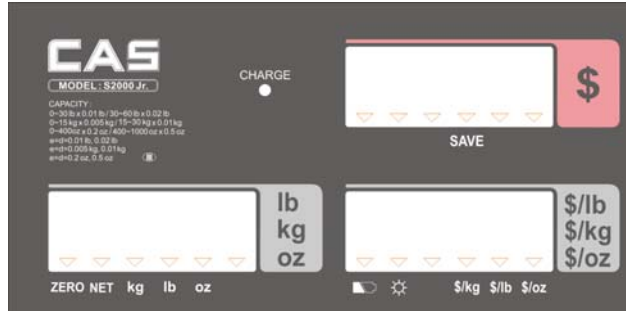

■ S2000 Jr. LCD TYPE : Rear Display



■ S2000 Jr. VFD TYPE : Front Display



■ S2000 Jr. VFD TYPE : Rear Display



■ S2000 Jr. – M LCD TYPE : Front Display

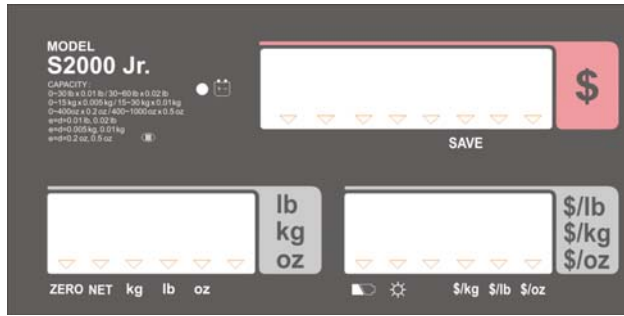



Table : Symbols on Display

SYMBOLS	DESCRIPTION
ZERO (▼)	To adjust Zero reference point
NET (▼)	Tare on
kg (▼)	Unit of weight is kilograms
lb (▼)	Unit of weight is pounds
oz (▼)	Unit of weight is ounces
 (▼)	Low battery warning
 (▼)	Back light on
\$/kg (▼)	Unit Price is per kilogram
\$/lb (▼)	Unit Price is per pound
\$/oz (▼)	Unit Price is per ounce
SAVE (▼)	Save function is enabled
CHARGE (▼)	Charge Status

■ KEYBOARD



■ S2000 Jr. Direct PLU Key pad

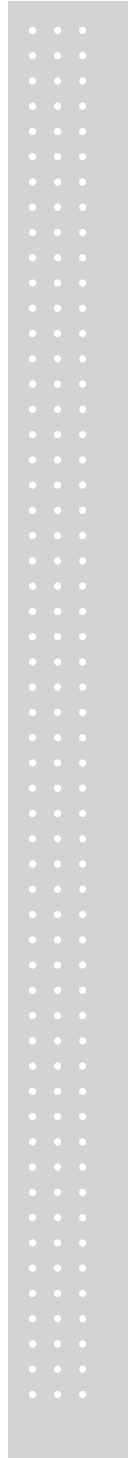
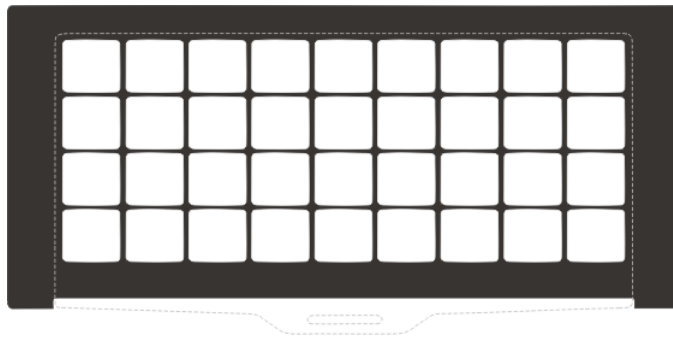















Table: Key Functions

KEYS	FUNCTIONS
	To input all numerical data
	Direct PLU keys
	To save PLU
	To call up PLU
	Used to prevent the auto clearing of unit price and weight
	Used to select weighing unit value. (kg, lb or oz)
	To clear data
	To set zero
	To set or clear tare value
	To turn on & off the scale
	Used to convert a unit price to a half pound
	Used to convert a unit price to a quarter pound
	Used to print out a label
	Direct PLU key (S2000 Jr. - M)

OPERATIONS

I. Programming Mode

Chapter 1. Basic Operation

- a. Turning the scale on / off
- b. Turning backlight on / off(LCD version only)
- c. Zero function
- d. Tare function
 - One Time tare
 - Successive tare
 - Preset tare

Chapter 2. PLU Saving & Calling-up

- a. Saving unit price on PLU
- b. Saving tare weight on PLU
- c. Saving valid date set on PLU(Optional)
- d. Saving PLU item code
- e. Saving PLU name
- f. Calling up PLU
 - Indirect PLU
 - Direct PLU

Chapter 3. User's Set-up Mode

- a. Auto power-off
- b. LCD backlight ON/OFF function (LCD version only)
- c. Brightness control (LCD version only)
- d. Low battery backlight auto off function(LCD version only)
- e. Stand By Mode Function (Only VFD version)
- f. Selecting the printer
- g. Use Tare with PLU
- h. Unit of Tare weight

Chapter 4. Formatting Printing Receipt

- a. Setting the Printer
- b. Receipt header setting
- c. Receipt currency (unit) setting
- d. Receipt DATE setting
- e. Receipt TIME setting
- f. Receipt Date format setting
- g. Samples of Print format

Chapter 1. Basic Operation

a. Turning the scale on / off

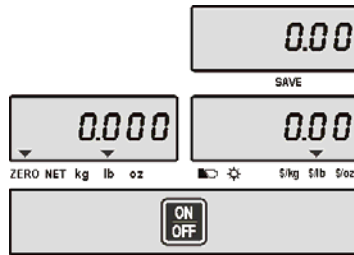

① Press **ON/OFF** key to turn on.

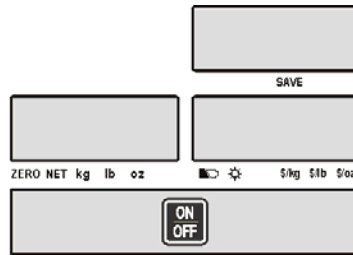

② Press **ON/OFF** key to turn off (VFD Version).
Press **ON/OFF** key for a few seconds to turn off (LCD Version)

b. Turning backlight on/off (LCD version only)

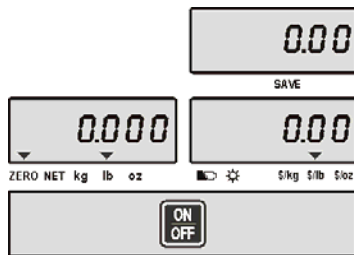

① Press **ON/OFF** key to turn on

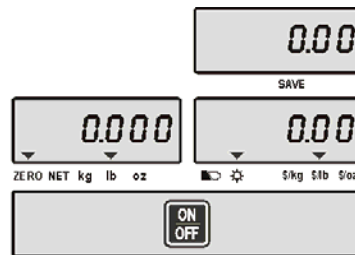

② Press **ON/OFF** key again to turn the backlight off.

c. Zero function

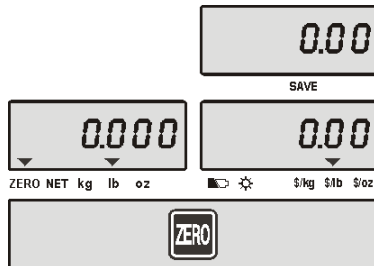

① Press **ZERO** key to set zero point.

d. Tare function

Tare means the weight of container. You may use the tare function when you weigh an item using a container and measure only the weight of the item.

■ One time tare

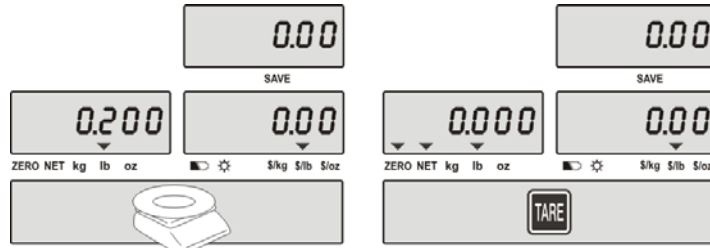

- ① Place a container on the platter.
Ex) 0.200 lbs of tare.

- ② Press **TARE** key to set zero point.
EX) 0.200 lbs of tare.

■ Successive tare

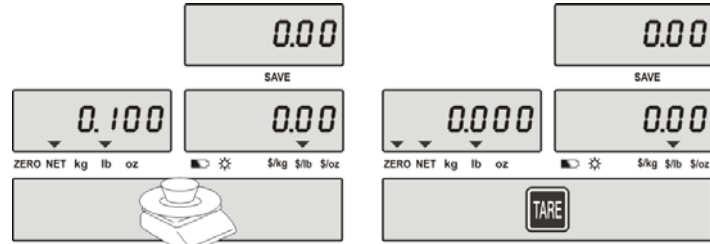

- ① Place another container on the platter.
Ex) 0.100 lbs of tare

- ② Press **TARE** key to set zero point

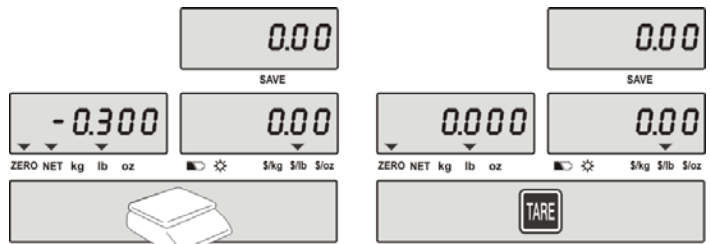

- ③ After weighing the item remove all of the containers from the platter.

- ④ Press **TARE** key again to set zero.

■ Preset tare

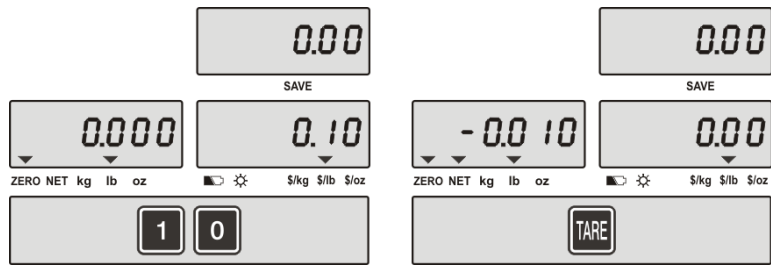

① Press appropriate numeric keys. Ex) 10g

② Press **TARE** key to set tare.

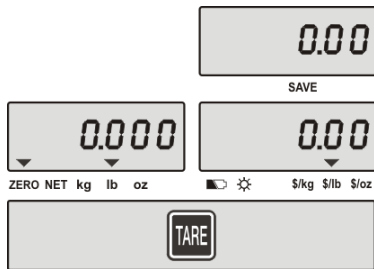

③ Press **TARE** key again to set zero.

Chapter 2. PLU Saving & PLU Calling-up

a. Saving unit price on PLU

This section explains how to save a unit price in the PLU.

	Number of PLU	Range	Remarks
PLU Name	200	1~200	

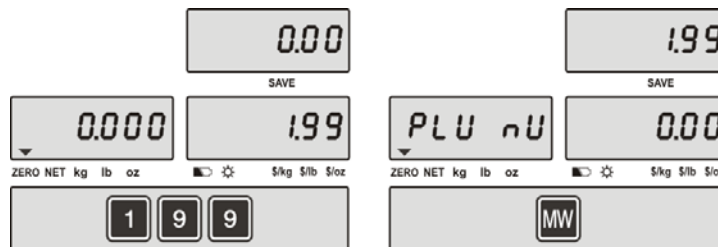

① Press numeric key to input unit price you wish to have. Ex) 1.99

② Press **MW** key.

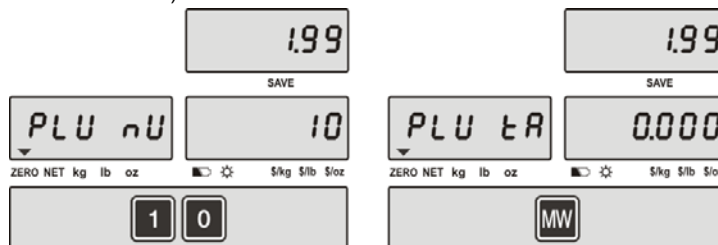

③ Press numeric key or speed key to input a PLU address. Ex) PLU 10.

④ Press **MW** key to save it.

b. Saving tare weight on PLU

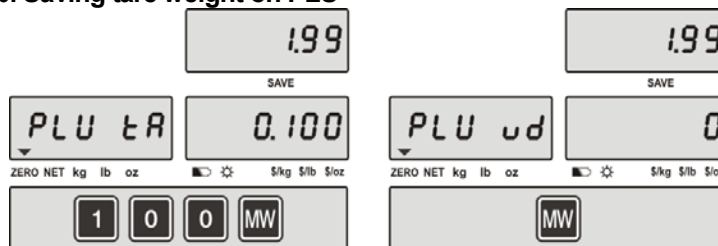

① Press numeric key to input tare weight you wish to have. And then press **MW** key to save it.. Ex) 0.100

② Press **MW** key.

Note: The "Save TARE with PLU" feature must be enabled in the User Settings.

Note: The **MW** key can be used to skip the **PLU tA**, valid date and item code. To skip the **PLU Name** press the **TARE** key and the scale will go directly to the weigh mode.

c. Saving valid date set on PLU

This section explains how to save valid date in PLU.
You can input the valid date. Range is 0 ~ 999.

Valid date	Packed on date	Sell by date	Remarks
0	12.11.07 (Today)	(No print)	
1	12.11.07 (Today)	12.11.07 (Today)	
2	12.11.07 (Today)	12.12.07 (Tomorrow)	
999	12.11.07 (Today)	09.04.10 (After 998 days)	

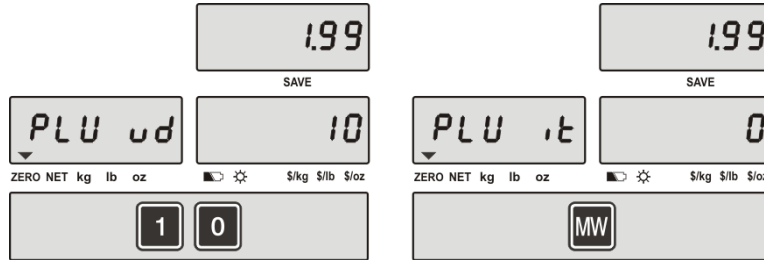

- ① Press numeric key to input a valid date
Ex) Sell by 9 days after
- ② Press **MW** key to save it.

d. Saving PLU item code

This section explains how to save valid date in PLU.

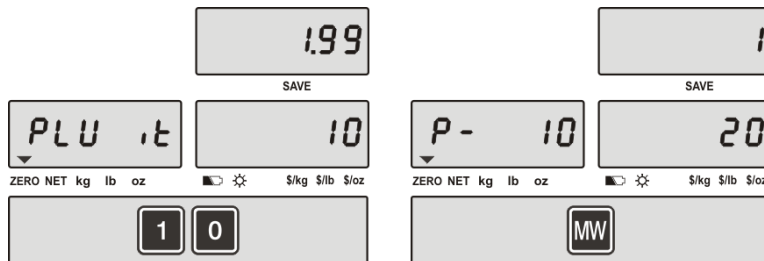

- ① Press numeric key to input a item code
Ex) Item code number "10"
- ② Press **MW** key to save it.

e. Saving PLU name

- **C** key is to input, save a character, and move to next character (or byte).
- **TARE** key is used to move to the next programming menu.

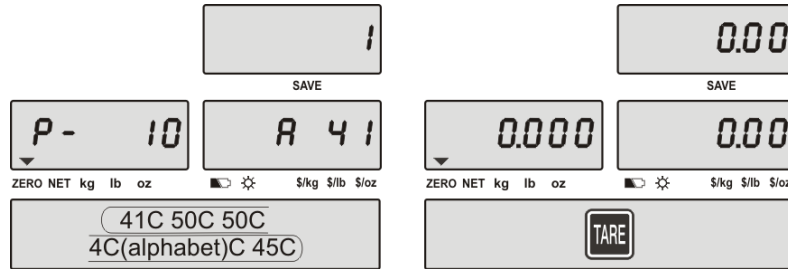

- ① Input appropriate ASCII codes to save the PLU name. Ex) "APPLE" is "4, 1, C, 5, 0, C, 5, 0, C, 4, C(alphabet), C, 4, 5, C"
**** Please refer to the ASCII table on page 36.**
- ② Press **TARE** key to exit to normal weighing mode or **C** key up to a maximum 16th byte to automatically exit to normal weighing mode.

■ Please refer to "Alphabetic key location".

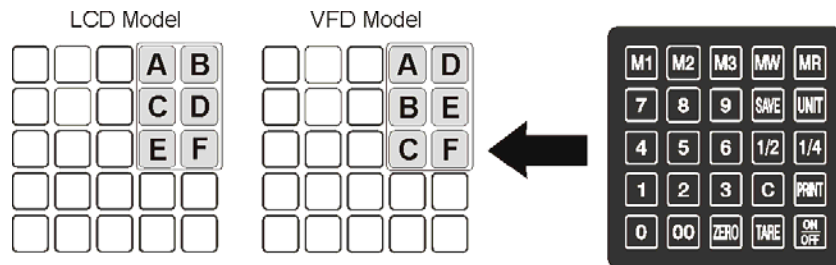

f. Calling up a PLU

■ Indirect PLU

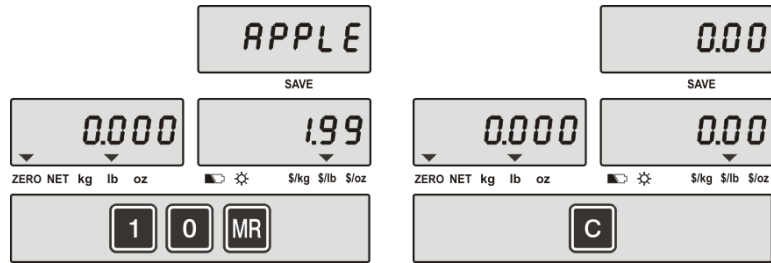

① To call up an indirect PLU that has been saved, press the appropriate numeric keys (address) and then the **MR** key
Ex) PLU 10

② To go back to normal weighing mode press **C** key

■ Direct PLU

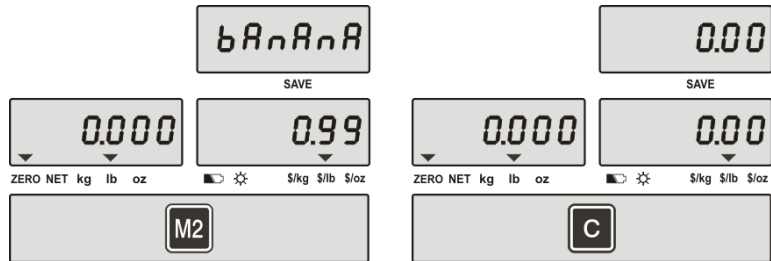

① To call up direct PLU saved just Press appropriate direct PLU key.
Ex) PLU 2

② To go back to normal weighing mode press **C** key

Chapter 3. User's Set-up Mode

This section explains how to set up the following functions.

Functions	Options	Remarks
a. Auto power-off	NO / 10 / 30 / 60	
b. LCD Backlight On/OFF	OFF / ON / 3 / 5 / 10	When backlight option selected in LCD version only
c. Backlight brightness	1 ~ 7	Default 3 (LCD version only)
d. Low battery backlight auto off	BL-on / BL-off	LCD version only
e. Stand By Mode	0 / 20 / 40 / 60	Only VFD version
f. Printer selection	NON / DEP-50 /DLP-50	
g. Use TARE in PLU	NO / Use	
h. Unit Setting of TARE	Lb / Kg/Oz	Only if (g.) is used

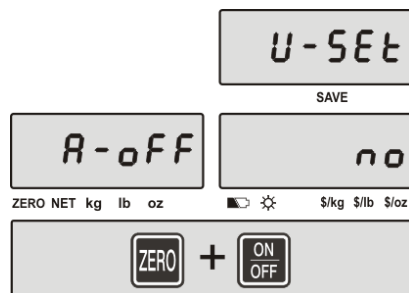

① To get into the "User's Set-up Mode", with the scale power OFF press the **ON/OFF** key while pressing and holding the **ZERO** key.

- Press the **ZERO** key to save the current option and move to the next function setting mode.
- Press the **TARE** key to move to the next option.

a. Auto power-off

This section explains how to set backlight on & off function and automatic off function.

Options	Description	Remarks
NO	No auto power-off.	
10 (minutes)	Auto power-off in 10 minutes when no use.	
30 (minutes)	Auto power-off in 30 minutes when no use.	
60 (minutes)	Auto power-off in 60 minutes when no use.	

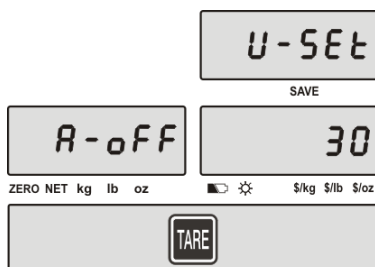

① Select an option you wish to have by using **TARE** key. Ex) 30 (minutes)

b. LCD backlight ON/OFF function (Option in LCD version only)

This section explains how to set backlight on & off function and automatic off function.

Options	Description	Remarks
OFF	Backlight always off	
ON	Backlight always on	
3 (Seconds)	Automatic backlight-off when not in use for 3 seconds.	
5 (Seconds)	Automatic backlight-off when not in use for 5 seconds.	
10 (Seconds)	Automatic backlight-off when not in use for 10 seconds.	

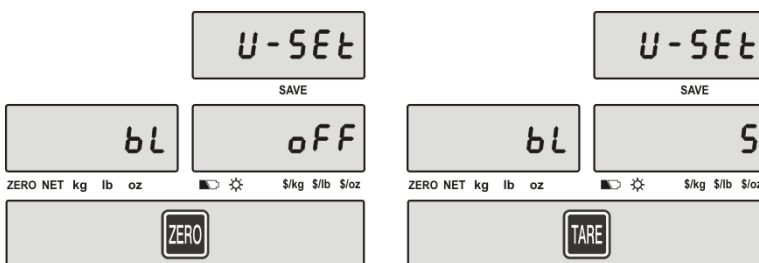

① Press **ZERO** key to move next function setting, backlight on/off

② Use **TARE** key to select one of backlight auto power-off option or backlight on/off
Ex) Select 5 seconds auto power-off option.

c. Brightness control (Option in LCD version only)

This section explains how to set brightness level (1~7)

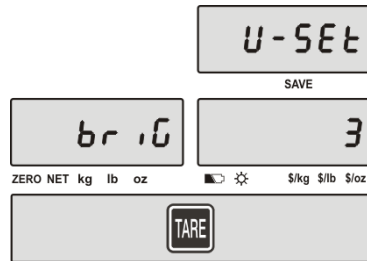

- ① Press **ZERO** key to move next function setting, backlight brightness.
- ② Press **TARE** key to select brightness. (1~7)

d. Low battery backlight auto off function (Option in LCD version only)

This section explains how to set backlight auto off. If the scale uses backlight auto off function, it will turn off when low battery indicator occurs.

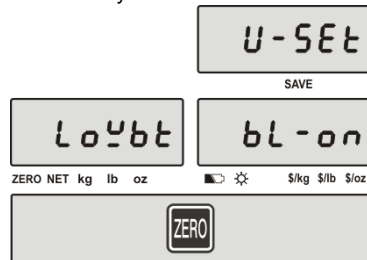

- ① Press **ZERO** key to move next function setting, low battery backlight auto off.
- ② Press **TARE** key to select backlight on/off.

※  : Low battery condition

e. Stand By Mode function (Only VFD version)

This section explains how to set the time until stand by mode.

Options	Description	Remarks
OFF	No Stand By mode.	
20 (seconds)	Stand By mode in 20 seconds when no use.	
40 (seconds)	Stand By mode in 40 seconds when no use.	
60 (seconds)	Stand By mode in 60 seconds when no use.	Default

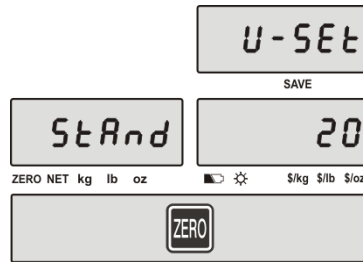

- ① Press **ZERO** key to move next function setting, stand by mode.
- ② Press **TARE** key to select a time to stand by mode.

f. Selecting the printer

This section explains how to select the printer option when you'd like to use a printer connected to the S2000 Jr.

Options	Description	Remarks
NON	No printer in use	
DEP-50	DEP-50 printer interface	
DLP-50	DLP-50 printer interface	

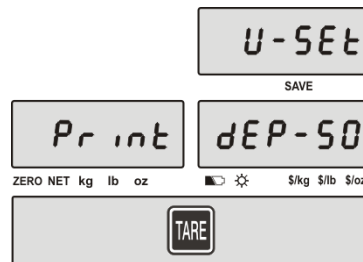

- ① Press **ZERO** key to move next function setting, selecting the printer
- ② Select the printer you're using with S2000 Jr by pressing **TARE** key. Ex) DEP-50

DLP-50 Printer Only

The following displays will be available when the DLP-50 Printer Interface is selected. They are used to program or select information that could be printed in a barcode.

- Press the **ZERO** key to save the current option and move to the next function setting mode.
- Press the **TARE** key to move to the next option.

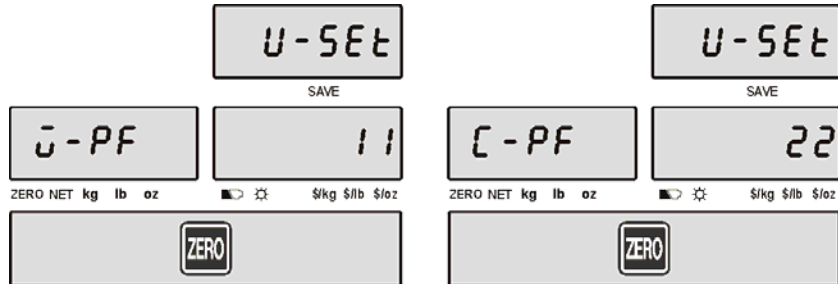

① Enter the desired Weight Product Prefix and Press the **ZERO** key. Ex) 11

② Enter the desired Count Product Prefix and Press the **ZERO** key. Ex) 22

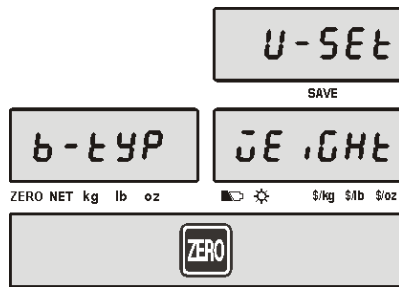

① Select **WEIGHT** or **PRICE** information to print in the barcode and Press the **ZERO** key. EX) **WEIGHT**



g. Use TARE with PLU

This section explains how to set Use TARE with PLU. If you want to assign a TARE weight in a PLU use this setting.

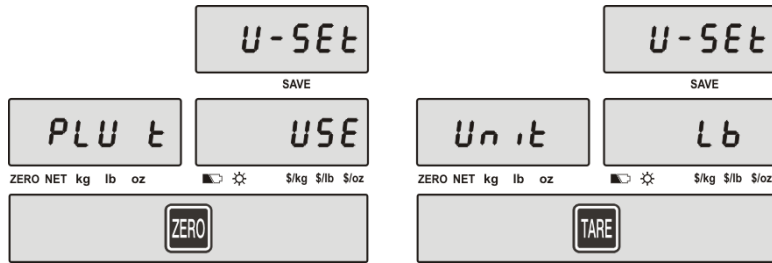

① Press **ZERO** key to move next function setting, Use TARE with PLU.

② Use the **TARE** key to select Kg or Lb. Press the **ZERO** key and scale will reboot.

Note: If you use Tare with PLU all other weigh modes are disabled.

Chapter 4. Formatting printing receipt

This chapter explains how to set the receipt format in the following fields.

To get into "Printing format Setup mode" Press ON/OFF key pressing and holding C key.

Options	Description	Remarks
HEADER	To input characters you wish to have on the receipt header.	Maximum 1,2 line / 24 characters , 3 line / 16 characters for each line
UNIT (Currency)	To input currency symbol or characters you wish to have on the receipt.	Maximum 8 characters
DATE	To input date on the receipt.	

a. Setting the printer

Please connect your printer to the RS-232 port, which is located at the gray part on the picture, using RS-232 cable.

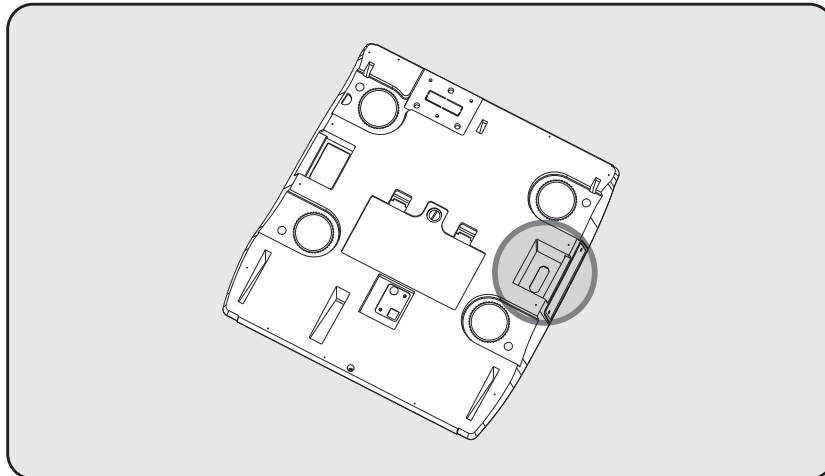

b. Receipt header setting

Options	Description	Remarks
HEADER	To input characters you wish to have on the receipt header.	Maximum 1,2 line / 24 characters, 3 line / 16 characters for each line.

- User may input the name of store, telephone number, or other information he/she wishes to have on the receipt.

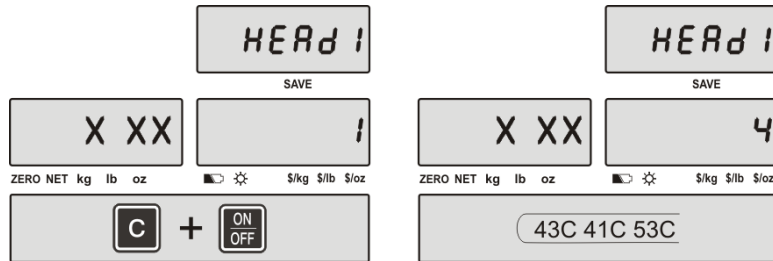

- Hold down the **C** key and press **ON/OFF** key under the scale power off. "1" on the "Unit Price" display represents that you are ready to input the first character.
- Input appropriate ASCII codes (page on 45) you wish to have. Ex) CAS.

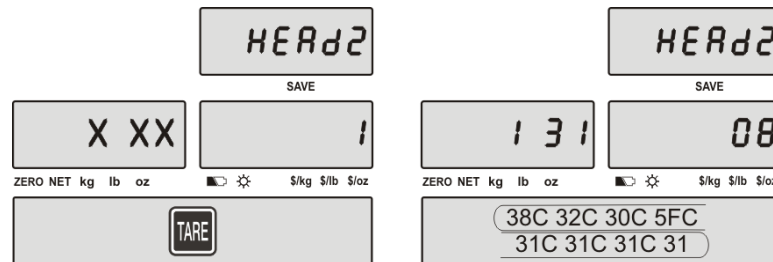

- To save it and go next header line press **TARE** key.
- Using ASCII code you can input appropriate data on Header 2. Ex) 820-1111, telephone#.

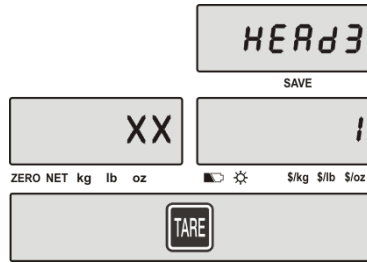

⑤ To save it and go to the next header line press **TARE** key.

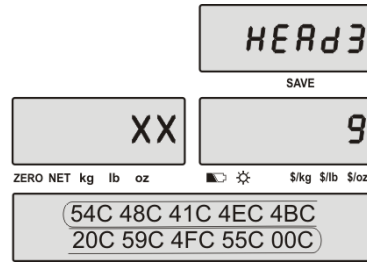

⑥ Using ASCII code you can input appropriate data on Header 2. Ex) THANK YOU

c. Receipt currency (unit) setting

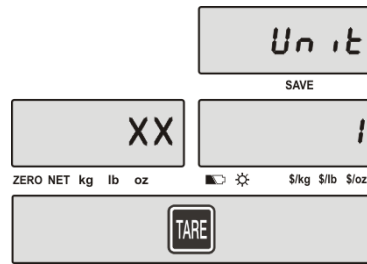

① Initial currency (unit) display status.

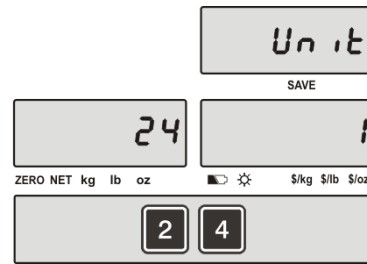

② Using ASCII code you can input appropriate character or currency symbols on unit. Ex) \$

d. Receipt DATE setting

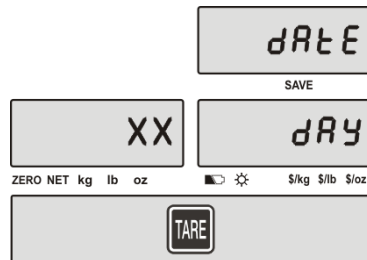

① To save it and go to "initial DATE display" status press **TARE** key.

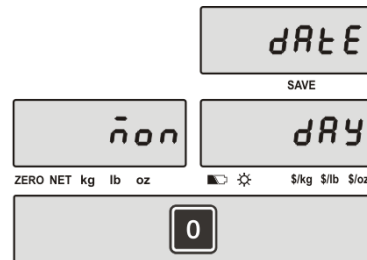

② Just input appropriate weekday you wish to have, using numeric key. Ex) 0 (Monday) ~ 6 (Sunday)

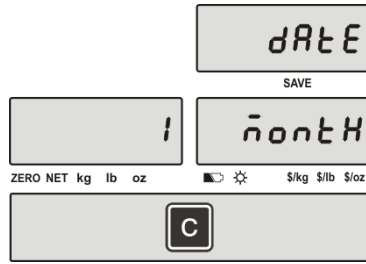

③ Press C key to go to next "Month" setting.

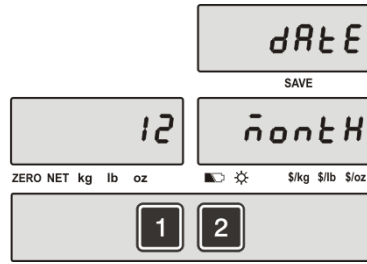

④ Just input appropriate month you wish to have, not using ASCII code. Ex) 12 (December)

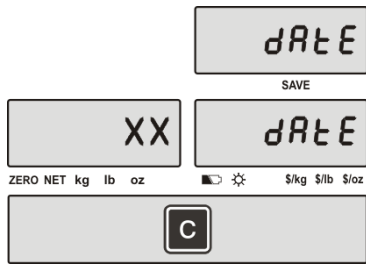

⑤ Press C key to go to next "Date" setting.

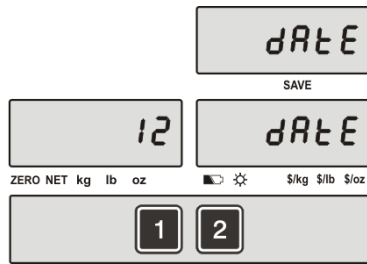

⑥ Just input appropriate date you wish to have, not using ASCII code. Ex) 12th day

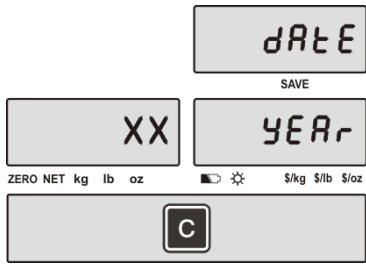

⑦ Press C key to go to next "Year" setting.

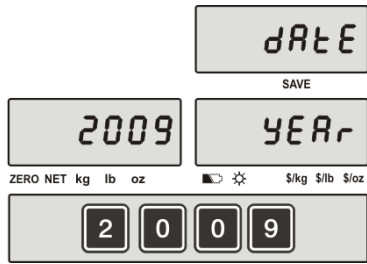

⑧ Just input appropriate year you wish to have, not using ASCII code. Ex) Year 2009

e. Receipt TIME setting

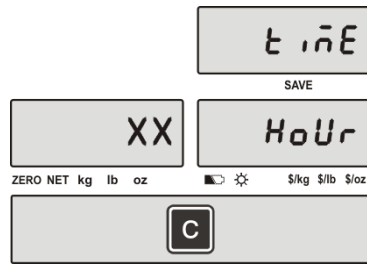

① Press **C** key to go to next "Hour" setting.

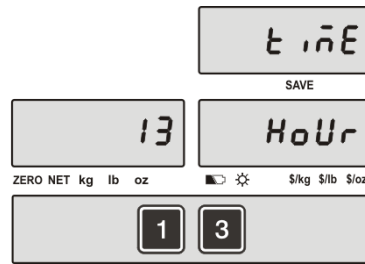

② Just input appropriate time you wish to have, not using ASCII code. Ex) Hour 13 (PM 1:00)

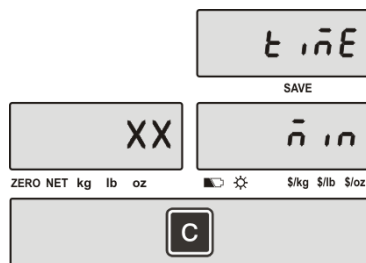

③ Press **C** key to go to next "Minute" setting.

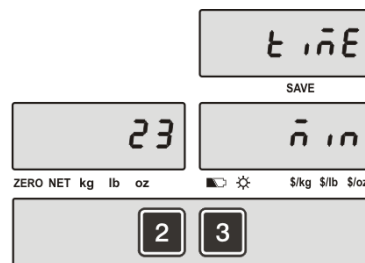

④ Just input appropriate minute you wish to have, not using ASCII code. Ex) Minute 23

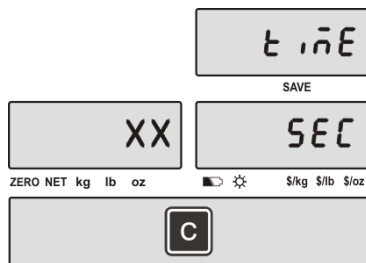

⑤ Press **C** key to go to next "Second" setting.

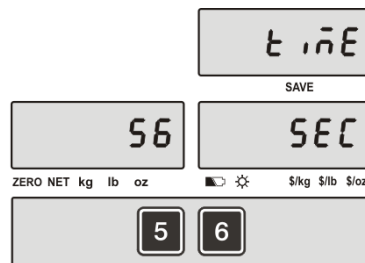

⑥ Just input appropriate second you wish to have, not using ASCII code. Ex) Second 56

f. Receipt Date format setting

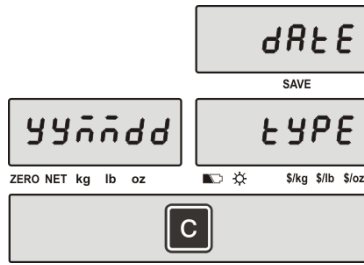

⑤ Press **C** key to go to next "Date format" setting.

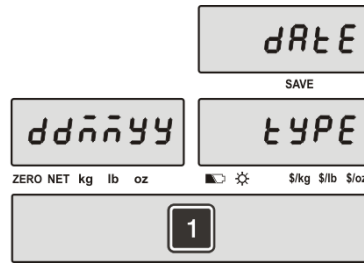

⑥ Just input a number according to below table.

Number	Date format
0	Year / Month / Date
1	Date / Month / Year



Ex) Press "1" to use DD/MM/YY print format

- If you press **C** or **TARE** key you will automatically go to the normal weighing mode.



g. Samples of Print format

■ DLP Printer

① When using weigh item or fixed item sale mode.

PLU NAME 12345678		PLU NAME 12345678					
Weight(kg)	Unit Price(\$/kg)	Weight(kg)	Unit Price(\$/kg)				
99.999	9999.99	99.999	9999.99				
PACKED ON : 07.12.03 SELL BY : 07.12.04 001		PACKED ON : 07.12.03 SELL BY : 07.12.04 001					
							
1 112345 999990		1 112345 999990					
<table border="1"> <tr><td>Total Price(\$)</td></tr> <tr><td>9999.99</td></tr> </table>		Total Price(\$)	9999.99	<table border="1"> <tr><td>Total Price(\$)</td></tr> <tr><td>9999.99</td></tr> </table>		Total Price(\$)	9999.99
Total Price(\$)							
9999.99							
Total Price(\$)							
9999.99							
Welcome to CAS Market !		Welcome to CAS Market !					
ERP type – Barcode indicates "Total price"		ERW type – Barcode indicates "Weight"					

□ When using multi item sale mode.

PLU NAME 12345678		PLU NAME 12345678					
PCS	Unit Price(\$/pcs)	PCS	Unit Price(\$/pcs)				
9999999	9999.99	9999999	9999.99				
PACKED ON : 07.12.03 SELL BY : 07.12.04 001		PACKED ON : 07.12.03 SELL BY : 07.12.04 001					
							
1 112345 999990		1 112345 999990					
<table border="1"> <tr><td>Total Price(\$)</td></tr> <tr><td>9999.99</td></tr> </table>		Total Price(\$)	9999.99	<table border="1"> <tr><td>Total Price(\$)</td></tr> <tr><td>9999.99</td></tr> </table>		Total Price(\$)	9999.99
Total Price(\$)							
9999.99							
Total Price(\$)							
9999.99							
Welcome to CAS Market !		Welcome to CAS Market !					
ERCP type – Barcode indicates "Total price"		ERCW type – Barcode indicates "PCS"					

■ DEP Printer

```

DATE. 2009/01/08/WED.
TIME. 15:27:59
=====
weight   unit price   total
(kg)    |   ($/kg)    ($)
=====
NO_PLU
   0.104   1234.56   128.39
=====
Sum($)                                128.39
    
```



II. Sales Mode

Chapter 5. Sales Transaction

- a. Sales with open price (input price during transaction)
- b. Sales using PLU
 - direct PLU
 - indirect PLU

Chapter 6. Daily Total Sales

- a. Calling up daily total sales data
- b. Deleting daily total sales data

Chapter 5. Sales Transaction

S2000 Jr. can have a sales transaction with either open price or with a preset PLU price.

a. Sales with open price (input price during transaction)

This section explains how to make a sales transaction with open price (input price during transaction).

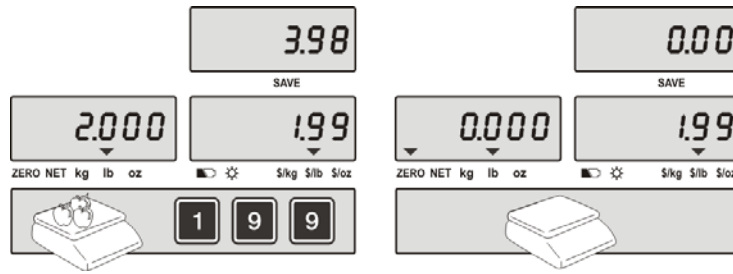

- ① Place an item on the platter and press appropriate numeric keys to input unit price. Ex) 1.99 for unit price.
- ② Remove the item from the platter.

b. Sales using PLU (Price Look-Up)

■ Direct PLU

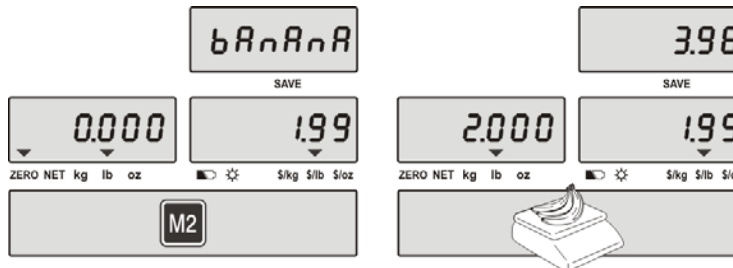

- ① Call up a direct PLU. Ex) "M2"
- ② Place an item on the platter.

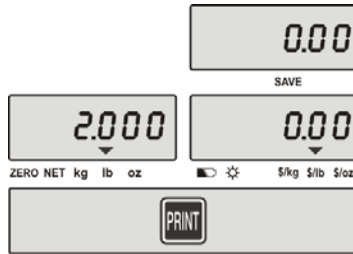

③ If you press **PRINT** key this transaction will add to the daily total amount and number of sales and the unit price & total price window are cleared.

- If the scale is connected printer, sale transaction data will printed out.

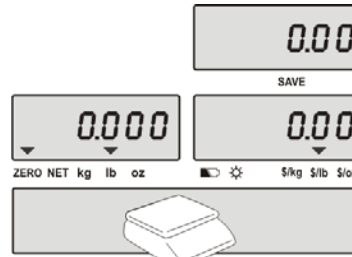

④ Remove the item from the platter.

■ Indirect PLU



① Call up an indirect PLU. Ex) "PLU 6 for Kiwi"

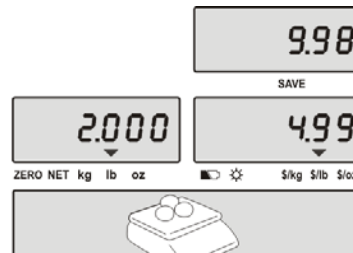

② Place an item on the platter.

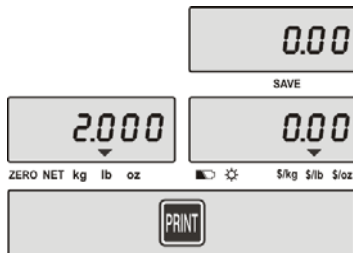

③ If you press **PRINT** key this transaction will add to the daily total amount and number of sales and the unit price & total price window are cleared.

- If the scale is connected printer, sale transaction data will printed out.

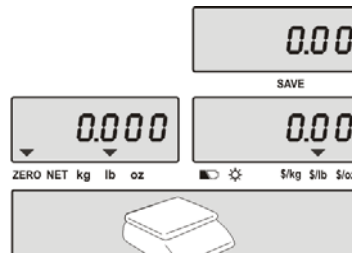

④ Remove the item from the platter.

Chapter 6. Daily Total Sales

a. Calling up daily total sales data

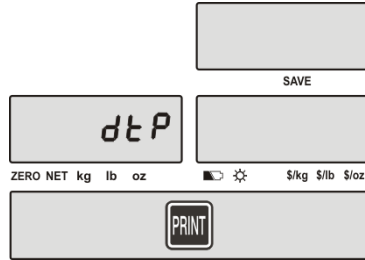

① Press **PRINT** key for 3 seconds until "dtP" message shows up.

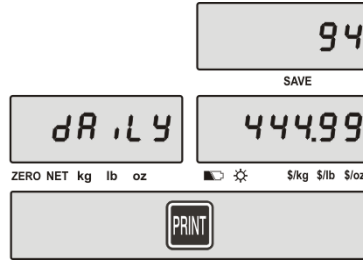

② Press **PRINT** key again to call up daily total sales.
Ex) daily total amount of sales = 444.99

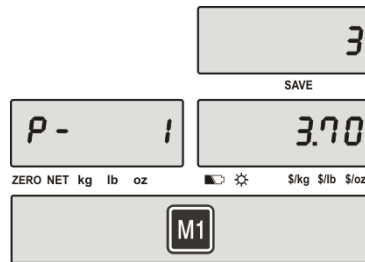

③ To view the sales amount of an individual PLU recall the appropriate PLU.
Ex) PLU#1 (Banana: Direct PLU) & PLU# 14.

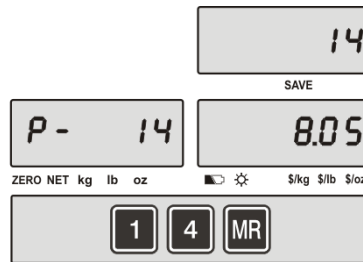

④ For PLU #14, press appropriate numeric keys and **MR** to show daily total amount of sales and the daily total number of sales transactions.

- To go back to "Daily total sales" mode simply press **PRINT** key.

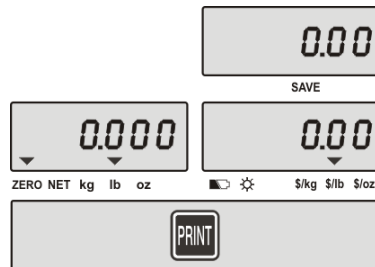

⑤ To go back to normal weighing mode, press **PRINT** key.

b. Deleting daily total sales data

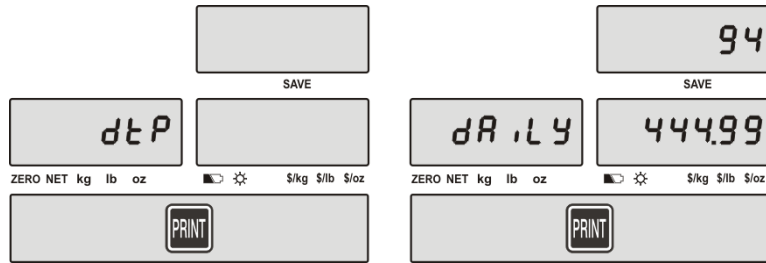

- ① Press **PRINT** key for 3 seconds until "dtP" message shows up.
- ② Press **PRINT** key again to call up daily total sales.
Ex) daily total amount of sales=444.99,

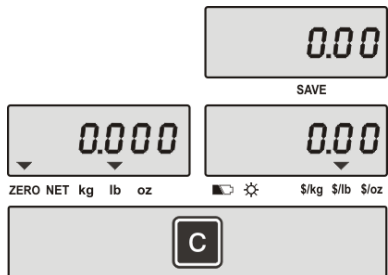

- ③ Press **C** key to delete "daily total sales" data.
"Clear" message will display and then returns to the normal weighing mode.

Table: ASCII Code

HIGH ORDER LOW ORDER	2	3	4	5	6	7	8	9
0	SP	0	@	P	'	p		
1	!	1	A	Q	a	q		
2	"	2	B	R	b	r		
3	#	3	C	S	c	s		
4	\$	4	D	T	d	t		
5	%	5	E	U	e	u		
6	&	6	F	V	f	v		
7	'	7	G	W	g	w		
8	(8	H	X	h	x		
9)	9	I	Y	i	y		
A	*	:	J	Z	j	z		
B	+	;	K	[k			
C	,	<	L	¥	l			
D	-	=	M]	m			
E	.	>	N	^	n			
F	/	?	O	_	o			

Picture1: Alphabet location on the keyboard

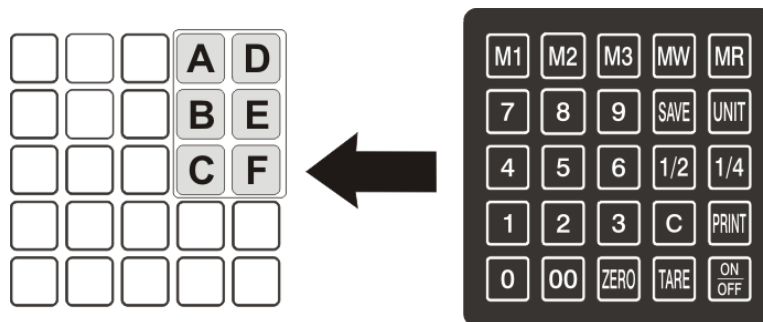

Table: Error Messages

Error Message on Display	Description	Solution
"Err 0"	The "Err 0" occurs when scale is not stable.	Remove unstable facts.
"Err 1"	The "Err 1" occurs when a current zero point has shifted from the last span calibration.	Please call your CAS dealer.
"Err 3"	The "Err 3" is an overload error.	Please remove the weight.
"Err 4"	The "Err 4" is short of payment.	Scale needs more payment.
"Err 5"	The "Err 5" means there is already tare.	Remove the tare.
"Err 6"	The "Err 6" means total price summation is over.	Please change unit price or remove some weight.
"Err 8"	The "Err 8" means Euro rating price is over.	Please change unit price or change euro rate.
"Err13"	The "Err13" means the soft key code is broken	Please try to find out which key lost soft key code and then input this code again.
"Err 15"	The "Err 15" means 1/2 or 1/4 unit price is over.	Please change unit price

Diagram : Serial Interface

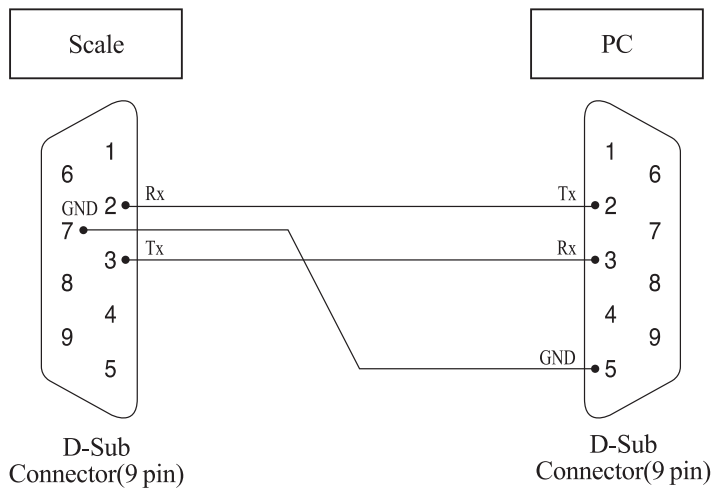

Table: SPECIFICATION

MODEL	S2000 Jr.		
CAPACITY	<u>Dual Interval</u> Max 3/6kg e = 1/2g	<u>Dual Interval</u> Max 6/15kg e = 2/5g	<u>Dual Interval</u> Max 15/30kg e = 5/10g
DISPLAY	S2000 Jr. : 5 / 6 / 6 (Weight/Unit Price/Total Price) S2000 Jr. - M : 6 / 6 / 8 (Weight/Unit Price/Total Price)		
SYMBOL ON DISPLAY	Power, Zero, Tare, Low battery, Backlight (Option for only LCD version)		
MAXIMUM TARE	- 2.999 kg	- 5.998 kg	- 14.995 kg
OPERATING TEMPERATURE	-10□ ~ +40□		
POWER SOURCE	12V DC Adaptor		
POWER CONSUMPTION	Approximately VFD Type 10W, LCD Type 5W		
PLATTER SIZE (mm)	304 (W) x 220 (D)		
PRODUCT SIZE (mm)	Pole Type : 360 (W) x 350 (D) x 410 (H) Standard Type : 360 (W) x 350 (D) x 106 (H)		
PRODUCT WEIGHT	Pole Type : 5.5kg Standard Type : 4.7kg		
MINIMUM VOLTAGE LEVEL OF THE BATTERY	About 5.6V		
RECHARGEABLE BATTERY LIFE	When battery is charged for 12 hours		
	LCD VERSION Approximately 200 hours (backlight off)	VFD VERSION Approximately 6 hours	
DRY BATTERY LIFE (S2000 Jr -M)	LCD VERSION Approximately 150 hours (backlight off)		
BATTERY TYPE	S2000 Jr. : Pb battery, 6V 4Ah/20Hr S2000 Jr.-M : Pb battery, 6V 4Ah/20Hr / 1.5V C type dry battery* 6EA		
OPTIONS	Pole, Backlight (only LCD version), Battery (only VFD version)		

□ Notice : specifications are subject to change for improvement without notice.

MEMO

MEMO

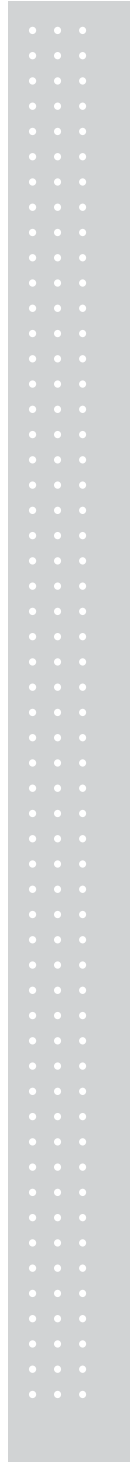

MEMO

S2000 Jr. SERIES

Price Computing Scale

SPAN CALIBRATION FOR S2000JR w/oz-SERIES

1. Make sure the scale is off.
2. Remove the two sealing bolts and the calibration plate on the bottom of the scale. Under the plate is the calibration switch.
3. Press and hold the switch while turning the scale on. The display will show “**onE**” and then “**CAL 1**”.
4. Use the “**ZERO**” to go through the cal option settings {cal1 to cal 11}. The “**TARE**” key enters the cal setting. If a per cent calibration is to be performed proceed to per cent calibration.
5. Before doing the calibration the middle up/down value has to be known. To do this go to “**CAL 10**” using the “**ZERO**” key until ‘**CAL 10**’ appears in the display. Press the “**TARE**” key to enter into the setting. First is “**UNIT**” then a number. The number represents the unit of calibration. 1 is for LBS and 0 is for KG.
6. Press the “**TARE**” key and the display will show “**CAPA**” and then the scales capacity. Press the “**TARE**” key and the display will show “**ñId**”. This is the middle up/down weight to be used in the calibration. This value CANNOT be set to 0. The value has to be between 10% and 90% of the full capacity expressed as weight not a percentage. Use the number keypad to key in the value of weight to be used. Keep pressing the “**TARE**” key to get back to “**CAL 10**”.
7. Keep pressing the “**ZERO**” key until the display shows “**CAL 3**”. Press the “**TARE**” key to enter into calibration.
8. The weight display will show “**2ErO**”. With the platter on the scale and nothing on the platter press the “**TARE**” key. The unit price display will count up and the total price display will show raw internal counts and then the display will show “**ñIdUP**” for 3 point calibration. Place the weight on the platter that was noted in step 6.
9. Press the “**TARE**” key. The unit price display will count up and the total price display will show raw internal counts and then the display will show “**FULL**”. Either remove the weight and/or add weights so that the full capacity weight of the scale is on the platter and press the “**TARE**” key.
10. The display will show internal counts and then display “**ñIddn**”. Put the same weight used in step 8 on the platter. Press the “**TARE**” key. The display will show internal counts and the go back to “**CAL 3**”. Remove the weight from the platter.
11. Press the “**C**” key and the scale will display the version, count up, and go into the weigh mode.

PER CENT CALIBRATION

1. Press the “**ZERO**” key until the display shows “**CAL 7**”. Press the “**TARE**” key to enter into per cent calibration.
2. The display will show “**Per 10**”. Key in the per cent of weight using the number keypad that is being used for calibration. The “**C**” key will clear the number. When the per cent is set press the “**TARE**” key.

3. The display will show **“2ErO”**. With the platter on the scale and nothing on the platter press the **“TARE”** key. The display will show internal counts and then display **“P5Pan”**.
4. Put the per cent of weight on the platter that was specified in step 2. Press the **“TARE”** key. The display will show internal counts and then go back to **“CAL 7”**. Remove the weight from the platter. Press the **“C”** key and the scale will display the version, count up, and go into the weigh mode.

SPAN CALIBRATION FOR S2000JR w/oz-SERIES

1. Make sure the scale is off.
2. Remove the two sealing bolts and the calibration plate on the bottom of the scale. Under the plate is the calibration switch.
3. Press and hold the switch while turning the scale on. The display will show “**onE**” and then “**CAL 1**”.
4. Use the “**ZERO**” to go through the cal option settings {cal1 to cal 11}. The “**TARE**” key enters the cal setting. If a per cent calibration is to be performed proceed to per cent calibration.
5. Before doing the calibration the middle up/down value has to be known. To do this go to “**CAL 10**” using the “**ZERO**” key until ‘**CAL 10**’ appears in the display. Press the “**TARE**” key to enter into the setting. First is “**UNIT**” then a number. The number represents the unit of calibration. 1 is for LBS and 0 is for KG.
6. Press the “**TARE**” key and the display will show “**CAPA**” and then the scales capacity. Press the “**TARE**” key and the display will show “**ñId**”. This is the middle up/down weight to be used in the calibration. This value CANNOT be set to 0. The value has to be between 10% and 90% of the full capacity expressed as weight not a percentage. Use the number keypad to key in the value of weight to be used. Keep pressing the “**TARE**” key to get back to “**CAL 10**”.
7. Keep pressing the “**ZERO**” key until the display shows “**CAL 3**”. Press the “**TARE**” key to enter into calibration.
8. The weight display will show “**2ErO**”. With the platter on the scale and nothing on the platter press the “**TARE**” key. The unit price display will count up and the total price display will show raw internal counts and then the display will show “**ñIdUP**” for 3 point calibration. Place the weight on the platter that was noted in step 6.
9. Press the “**TARE**” key. The unit price display will count up and the total price display will show raw internal counts and then the display will show “**FULL**”. Either remove the weight and/or add weights so that the full capacity weight of the scale is on the platter and press the “**TARE**” key.
10. The display will show internal counts and then display “**ñIddn**”. Put the same weight used in step 8 on the platter. Press the “**TARE**” key. The display will show internal counts and the go back to “**CAL 3**”. Remove the weight from the platter.
11. Press the “**C**” key and the scale will display the version, count up, and go into the weigh mode.

PER CENT CALIBRATION

1. Press the “**ZERO**” key until the display shows “**CAL 7**”. Press the “**TARE**” key to enter into per cent calibration.
2. The display will show “**Per 10**”. Key in the per cent of weight using the number keypad that is being used for calibration. The “**C**” key will clear the number. When the per cent is set press the “**TARE**” key.

3. The display will show **“2ErO”**. With the platter on the scale and nothing on the platter press the **“TARE”** key. The display will show internal counts and then display **“P5Pan”**.
4. Put the per cent of weight on the platter that was specified in step 2. Press the **“TARE”** key. The display will show internal counts and then go back to **“CAL 7”**. Remove the weight from the platter. Press the **“C”** key and the scale will display the version, count up, and go into the weigh mode.