

WLY

PRECISION BALANCES

USER MANUAL

ITKU-122-01-11-20-EN



RADWAG® RADWAG BALANCES AND SCALES
ADVANCED WEIGHING TECHNOLOGIES

NOVEMBER 2020

SERIES:











Model		Max	d	e	Weighing pan dimensions
WLY 1/D2	-	1kg	0.01g	-	195x195mm
WLY 2/D2	-	2kg	0.01g	-	195x195mm
WLY 6/D2	✓	6kg	0.1g	-	195x195mm
WLY 6/F1/R	✓	6kg	0.1g	1g	300x300mm
WLY 6/F1/K	✓	6kg	0.1g	1g	300x300mm
WLY 10/D2	-	10kg	0.1g	-	195x195mm
WLY 12/F1/R	-	12kg	0,2g	-	300x300mm
WLY 12/F1/K	-	12kg	0,2g	-	300x300mm
WLY 20/D2	-	20kg	0.1g	-	195x195mm
WLY 30/F1/R	-	30kg	0,5g	-	300x300mm
WLY 30/F1/K	-	30kg	0,5g	-	300x300mm
WLY 60/C2/R	✓	60kg	1g	10g	400x500mm
WLY 60/C2/K	✓	60kg	1g	10g	400x500mm
WLY 120/C2/R	-	120kg	2g	-	400x500mm
WLY 120/C2/K	-	120kg	2g	-	400x500mm



For detailed technical specifications refer to RADWAG website www.radwag.com/pl/.

PRECAUTIONS

Prior to installation, use or maintenance activities, carefully read this user manual. Use the PUE 7.1 Indicator only as intended.

	Prior to the first use, carefully read this user manual. Use the device only as intended.
	Place loads in the centre of the weighing pan.
	Load the weighing pan with loads of gross weight which does not exceed the maximum capacity.
	Mind not to leave heavy loads on the weighing pan for longer periods of time.
	Do not operate the touch panel using sharp-edged tools (knife, screwdriver, etc.).
	Protect the indicator against considerable temperature variation, solar and UV radiation, substances causing chemical reactions.
	The device must not be operated in hazardous areas endangered with explosion of gases, and in dusty environments.
	In case of damage, immediately unplug the device from the mains.
	Scales to be decommissioned must be decommissioned in accordance with valid legal regulations.
	If the scale is to be operated in conditions that are difficult due to electrostatics (e.g. printing house, packing centre, etc.), you must connect it to the earth wire. To enable this, the device features functional earthing terminal, marked with \perp symbol.
	Wi-Fi® is a registered trademark of Wi-Fi Alliance. The trademark used in this document serves informative purposes, it does not stand for compliance of any products with products certified by Wi-Fi Alliance organisation.

Contents

1. INTENDED USE	6
2. WARRANTY CONDITIONS	6
3. MAINTENANCE	7
3.1. Cleaning ABS Components.....	7
3.2. Cleaning Stainless Steel Components.....	7
4. SERVICE AND REPAIR	7
5. RECYCLING	8
6. MECHANICAL DESIGN	8
6.1. Dimensions.....	9
6.2. Connectors	10
6.3. RS232 Connector	10
6.4. Inputs / Outputs	10
6.4.1. Technical Specifications.....	11
6.4.2. I/O Schematic Diagrams	11
6.5. Operation Panel.....	12
7. INSTALLATION	13
7.1. UNPACKING AND INSTALLATION.....	13
7.1.1. WLY/D2 Series	13
7.1.2. WLY/C2, WLY/F1 Scales	13
7.2. Levelling.....	14
7.3. Start-Up	14
7.4. Warm-Up Time	14
8. HOME SCREEN	15
8.1. Top Bar	15
8.2. Weighing Result Window	16
8.3. Workspace.....	16
8.4. Function Buttons.....	16
9. OPERATING THE MENU	16
9.1. Operation Panel.....	16
9.2. Return to Weighing.....	17
10. WEIGHING	18
11. DIAGRAMS OF CONNECTION CABLES	19
12. ERROR MESSAGES	20

1. INTENDED USE

The scales are a response to growing market demands for an instrument offering simplicity of operation and weighing process automated to the maximum. WLY series scales enable fast and accurate mass measurement in laboratory. Modern, electronic weighing module with a colour 5,7" graphic display (with a touch screen) offers intuitive and user-friendly software.

The scale is equipped with 2 USB connectors, 2 RS232 connectors, Ethernet port, 4 IN/OUT, Wi-Fi[®] b,g,n. It can connect with barcode scanners, receipt printers, label printers,RFID readers and PC accessories (a mouse, a keyboard, a USB flash drive).

2. WARRANTY CONDITIONS

- A. RADWAG feels obliged to repair or exchange all elements that appear to be faulty by production or by construction.
- B. Defining defects of unclear origin and means of their elimination can only be realized with assistance of the manufacturer and user representatives.
- C. RADWAG does not bear any responsibility for damage or losses resulting from unauthorized or inadequate performing of production or service processes.
- D. The warranty does not cover:
 - mechanical damage caused by product exploitation other than intended, damage of thermal and chemical origin, damage caused by lightning, overvoltage in the power grid or other random event,
 - inappropriate cleaning habits.
- E. Loss of warranty takes place if:
 - a repair is carried out outside RADWAG authorized service point,
 - service claims intrusion into mechanical or electronic construction by unauthorized people,
 - other than original version of the operating system is installed,
 - the scale does not bear security seal stickers.
- F. For detailed warranty conditions read the warranty certificate.
- G. Contact with the central authorized service: +48 (48) 386 63 30.

3. MAINTENANCE

In order to clean the weighing instrument risk-free, it is necessary to disconnect the device from the mains. With this condition met, uninstall the weighing pan and other detachable scale components.



Cleaning the weighing pan while still installed may cause damage of the measuring system.

3.1. Cleaning ABS Components

To clean dry surfaces and avoid smudging, use clean non-colouring cloths made of cellulose or cotton. You can use a solution of water and detergent (soap, dishwashing detergent, glass cleaner). Gently rub the dirty surface and let it dry. Repeat the cleaning process if necessary.

In the case of hard to remove contamination, e.g. residues of adhesive, rubber, resin, polyurethane foam etc., you can use special cleaning agents based on a mixture of aliphatic hydrocarbons that do not dissolve plastics. Before using the cleanser, for all surfaces we recommend carrying out tests. Do not use cleansers containing abrasive substances.

3.2. Cleaning Stainless Steel Components

Avoid using cleansers containing any corrosive chemicals, e.g. bleach (with chlorine). Do not use cleansers containing abrasive substances. Always remove the dirt using microfiber cloth to avoid damage of protective coating. In case of a daily maintenance:

1. Remove the dirt using cloth dipped in warm water.
2. For best results, add a little bit of dishwashing detergent.

4. SERVICE AND REPAIR



In case of any sign of damage, it is necessary to disconnect the device from the mains immediately. The damaged component must be replaced or repaired by RADWAG service directly.

In case of any problems with correct operation of the scale, contact the closest manufacturer's service point.

In case of defects, deliver the faulty product to the manufacturer's service point. If the product cannot be delivered to the manufacturer's service point, call the service and report the defect. Repair scope and method will be set up.



The user is NOT ALLOWED to carry out any kind of repair of the device himself/herself. Any attempt of scale modification, repair etc., by unauthorized persons, will result with loss of validity of manufacturer-issued certificates, declarations and warranty.

5. RECYCLING

WLY scales must be recycled, they are not to be treated as a regular household waste. Scales to be decommissioned must be decommissioned in accordance with valid legal regulations.



6. MECHANICAL DESIGN

WLY scale is a 1-load-cell device intended to carry out fast and precise mass measurement of up to 120 kg loads. Its characteristic feature is a platform with one load cell only. The platform is equipped with a stainless steel weighing pan. Depending on a scale model, the cross and base are made of either stainless steel or powder-coated steel.

1-load-cell scale design, the main components

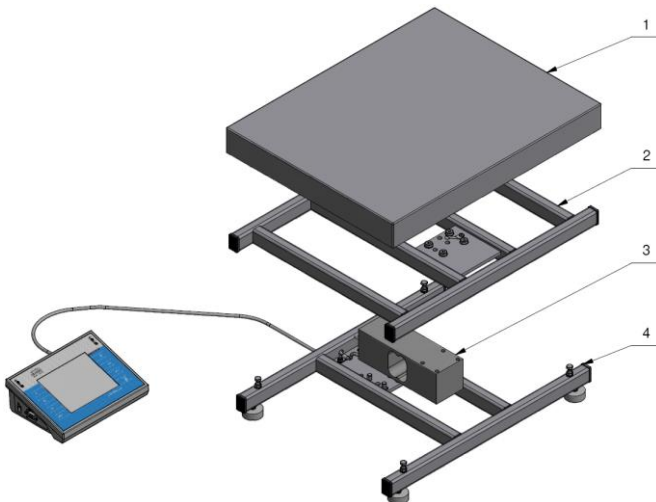

*1-load-cell scale design, the main components:
1- – weighing pan, 2 – cross, 3 - load cell, 4 - base.*

6.1. Dimensions

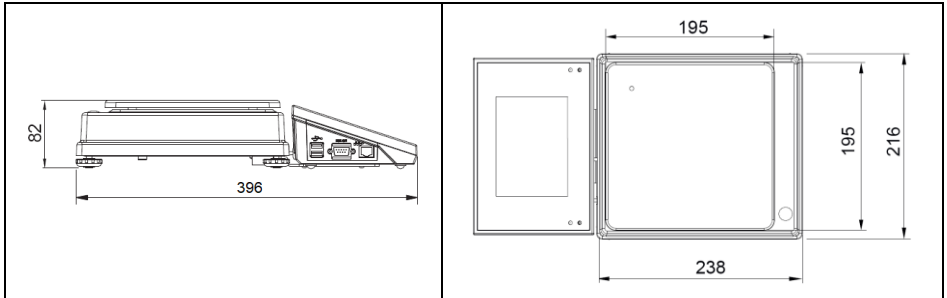

Dimensions of WLY/D2 scale

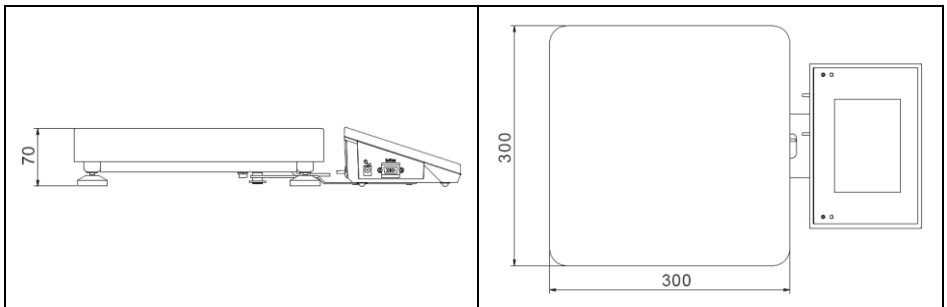

Dimensions of WLY/F1 scale

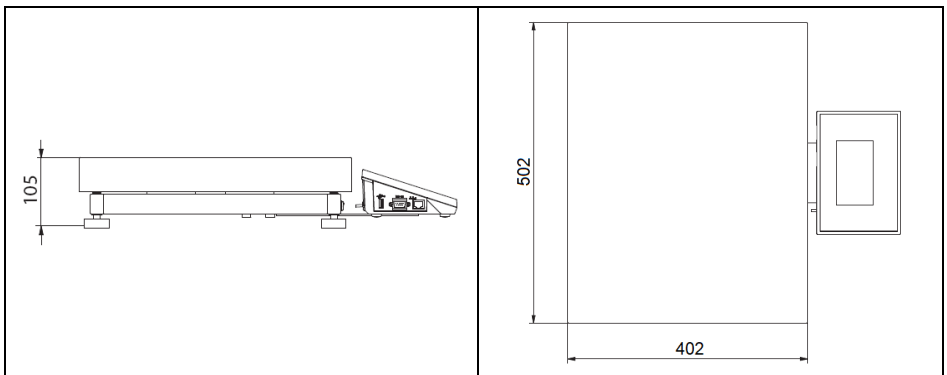

Dimensions of WLY/C2 scale

6.2. Connectors

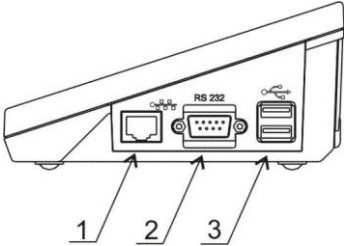
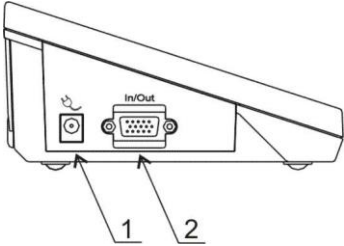
	
<p>1 – Ethernet RJ45 connector 2 – RS232 (COM1) connector 3 – USB connector</p>	<p>1 – power supply socket 2 – I/O, RS232 (COM2) connector</p>

6.3. RS232 Connector

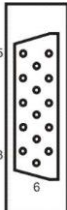
	<p>RS232 - DB9/M connector (male), front:</p> <p>Pin2 - RxD Pin3 - TxD Pin4 - +5 V DC Pin5 - GND</p>
	<p>RS232 - DSUB15/F connector (female), front:</p> <p>Pin8 - Tx D2 Pin9 - 5VDC Pin10 - GND Pin13 - Rx D2</p>

6.4. Inputs / Outputs

Standard C32 scale is equipped with 4 optoisolated inputs and 4 semiconductor outputs (solid-state relays). The signals are fed through DSUB15/F connector.

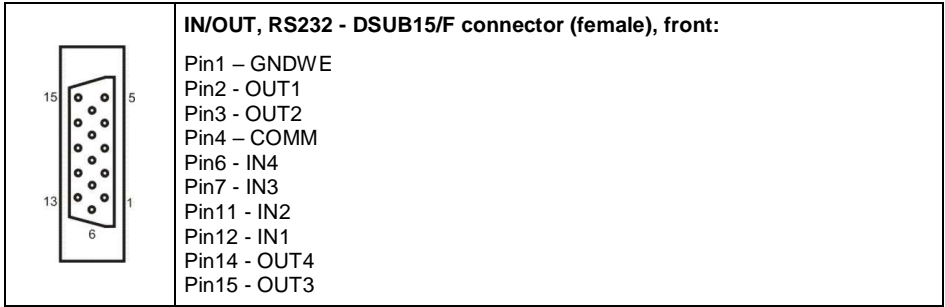

6.4.1. Technical Specifications

Output parameters	
Output quantity	4
Output type	Solid-state relay
Cable cross-section	0.14 - 0.5 mm ²
Maximum output current	0.5 A DC
Maximum output voltage	30 VDC
Input parameters	
Input quantity	4
Input type	Optoisolated
Cable cross-section	0.14 - 0.5 mm ²
Input voltage range	5÷24VDC



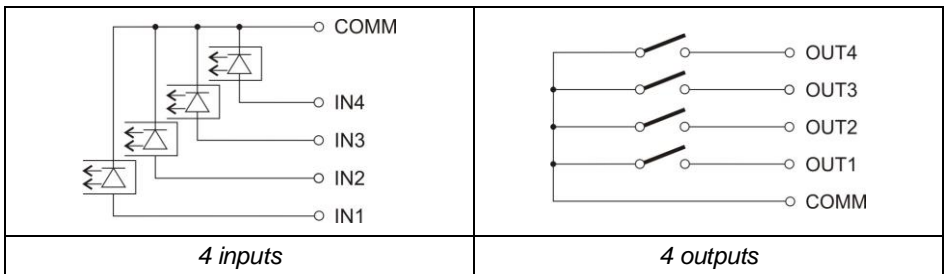



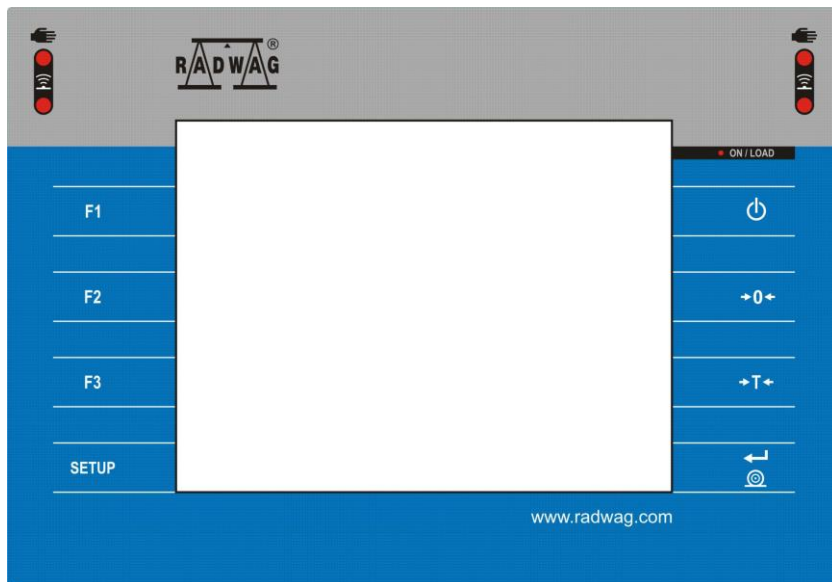

6.4.2. I/O Schematic Diagrams



6.5. Operation Panel



Keys

	Press to switch the scale ON/OFF.
	Press to zero the scale.
	Press to tare the scale.
	Press to send the weighing result to a printer or a computer.
	Press to enter the menu (function button).
	Programmable key.
	Programmable key.
	Programmable key.

7. INSTALLATION

7.1. UNPACKING AND INSTALLATION

7.1.1. WLY/D2 Series

- A. Take the device out of the packaging.
- B. Place the device on a flat and even surface. Keep it far away from any sources of heat.
- C. Install the weighing pan and the indicator holder in accordance with the figure below:

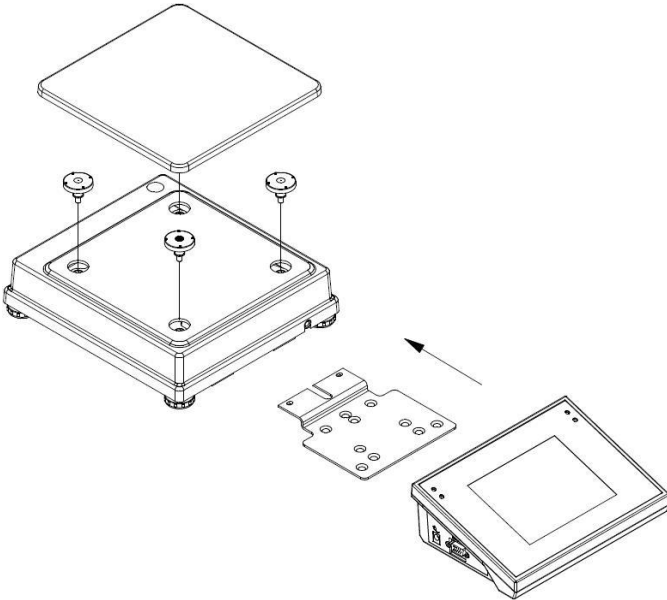

7.1.2. WLY/C2, WLY/F1 Scales

- Take the device out of the packaging.
- Place the device on a flat and even surface. Keep it far away from any sources of heat.
- Remove transport locks and install the weighing pan:

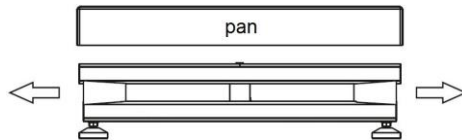

7.2. Levelling



It is necessary to level the scale, do it by turning its feet. Keep turning the feet until the air bubble takes central position.



7.3. Start-Up

The weighing device can be connected to the mains only with a power supply that comes standard with the particular model. Nominal voltage of the power supply (specified on the power supply data plate) has to be compatible with the mains nominal voltage.

Procedure:

- Plug the power supply to the mains.
- Connect the power supply plug to the socket located on the scale's side. An ON/LOAD diode,  ON / LOAD, on indicator housing is turned on.
- Press  key, it is to be found at the top of the operation panel. Mind to keep the key pressed for about 0.7 s. Operation system and RADWAG program are loaded, this is signalled with blinking of red ON/LOAD diode.
- Upon completed start-up, the home screen is displayed automatically.



Detailed instruction on how to configure the home screen is to be found in „PUE 7.1 Indicator Software Manual”.

7.4. Warm-Up Time

- For correct scale operation, the workroom temperature must range between $+15^{\circ}\text{C} \div +30^{\circ}\text{C}$.
- It takes 30 minutes for the device to warm up.
- During the thermal stabilization, the indications on the screen may change.
- If you want to carry out adjustment operation, make sure that your device is thermally stable.

8. HOME SCREEN

The home screen features 4 sections: a top bar, a weighing result window, a workspace, function buttons.

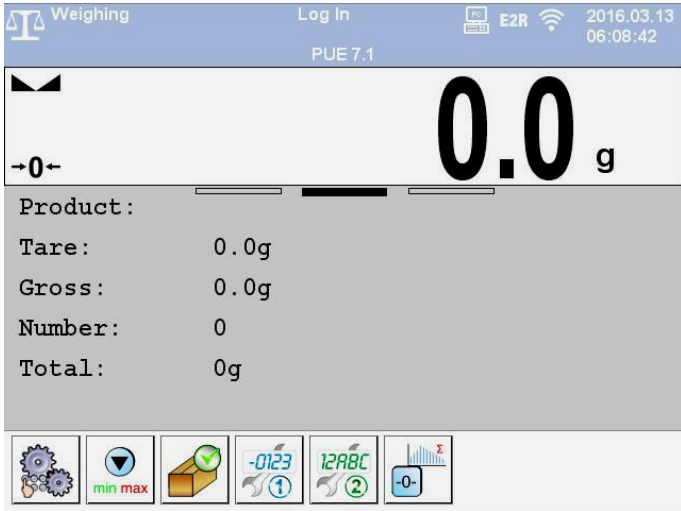

Home screen layout:

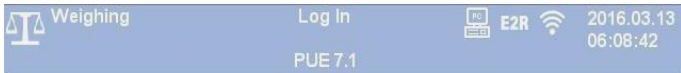

8.1. Top Bar



The top bar displays the following information:

 Weighing	Working mode name and symbol.
Log In	Log-in entry.
	Symbol informing that communication with a PC is on.
	Symbol informing that Wi-Fi® connection is on.
E2R	Symbol informing that communication with E2R SYSTEM is on.
PUE 7.1	Device name.
2012.06.06 06:06:06	Date and time.

8.2. Weighing Result Window

Weighing result window provides all weighing-related data.



8.3. Workspace

The workspace is to be found underneath the weighing result window.

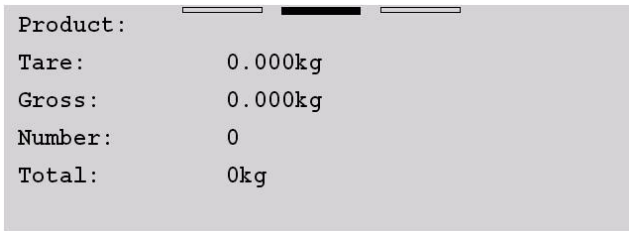

The workspace comprises 3 display templates. Graphics at the top inform which of the 3 templates is currently displayed. In order to switch to a different template drag the workspace screen to the left/right respectively.

8.4. Function Buttons

On-screen function buttons are to be found underneath the workspace.



















You can define on-screen function buttons individually for each working mode.

9. OPERATING THE MENU



9.1. Operation Panel

	Press to enter the menu.
	Press to scroll the menu up.
	Press to scroll the menu down.
	Press to scroll the menu up-down fast.

	Press to confirm modifications.
	Press to exit, the parameter remains unmodified.
	Press to add a database record.
	Press to disable the selected record. Press to log out.
	Press to search a particular database record by date.
	Press to search a particular database record by name.
	Press to search a particular database record by code.
	Press to print a database record.
	Press to export control and average tare reports for PGC and SQC modes. Press to export dosing and formulation reports.
	Press to clear dialog box content.
	Press to enable/disable an on-screen keyboard.
	Press to read printout template saved to *.lb file (the button becomes active upon USB flash drive connection).
	Press to save the template to *.lb file (the button becomes active upon USB flash drive connection).
	Press to select printout template variables out of the list.
	Press to go back.
	Press to go to the home screen directly.

9.2. Return to Weighing

Introduced modifications are automatically recorded upon return to the home screen. To return to the home screen:

- press  key repeatedly, keep pressing the key until you see the home screen,
- press  field, located in the top bar, the home screen is displayed immediately.

10. WEIGHING

Load the weighing pan. Read the result when  stability marker is displayed. In order to guarantee a long-term operation, wherein correct measurements are provided, the following principles must be adhered to:

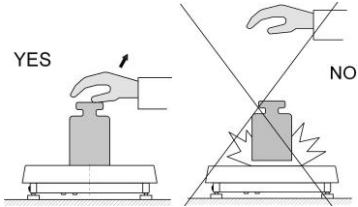
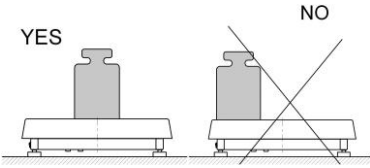
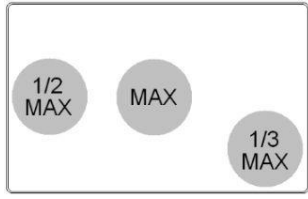
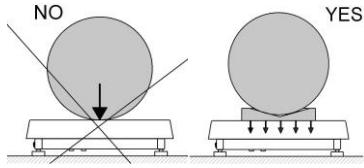
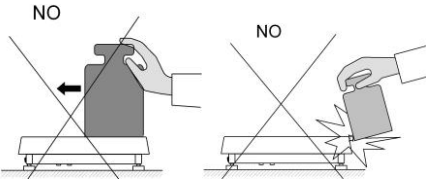
<p>Load the weighing pan steadily, avoid applying mechanical shocks.</p>	
<p>Place the loads centrally on the weighing pan (eccentricity errors are specified by EN 45501 standard, point 3.6.2).</p>	
<p>In case of eccentric loading make sure that: a) mass of load placed close to one of the pan edges does not exceed $\frac{1}{2}$ of max capacity, b) mass of load placed in the pan corner does not exceed $\frac{1}{3}$ of max capacity.</p>	
<p>Do not apply concentrated force (total load in one point).</p>	
<p>Avoid side loading, in particular side shocks.</p>	

11. DIAGRAMS OF CONNECTION CABLES

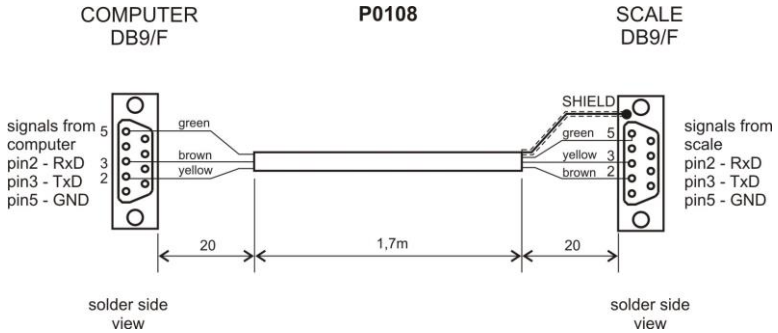

Scale - computer cable (RS232)

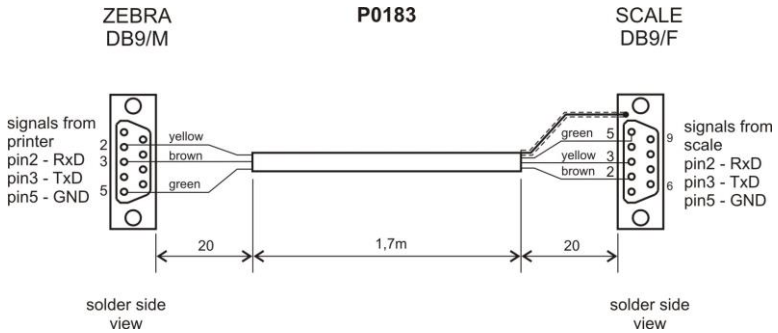

Scale - printer cable (ZEBRA)

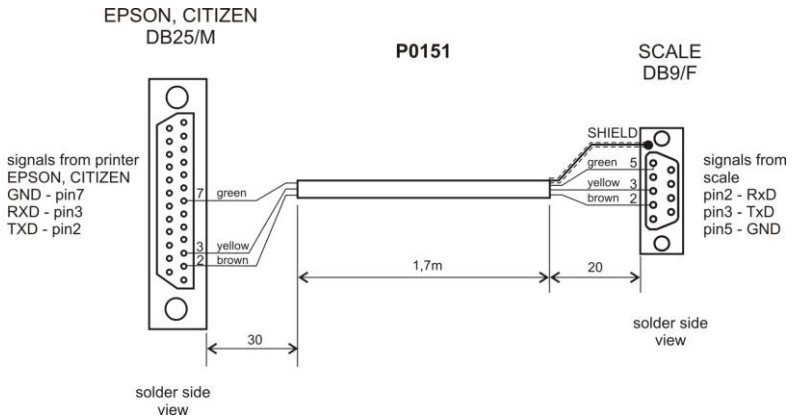

Scale - printer cable (EPSON)

SCALE
DSUB15/M

PT0128

Signals from scale
pin1 - GND_IN
pin2 - OUT1
pin3 - OUT2
pin4 - COMM
pin6 - IN4
pin7 - IN3
pin8 - TxD2
pin9 - 5VDC
pin10 - GNDRS
pin11 - IN2
pin12 - IN1
pin13 - RxD2
pin14 - OUT4
pin15 - OUT3

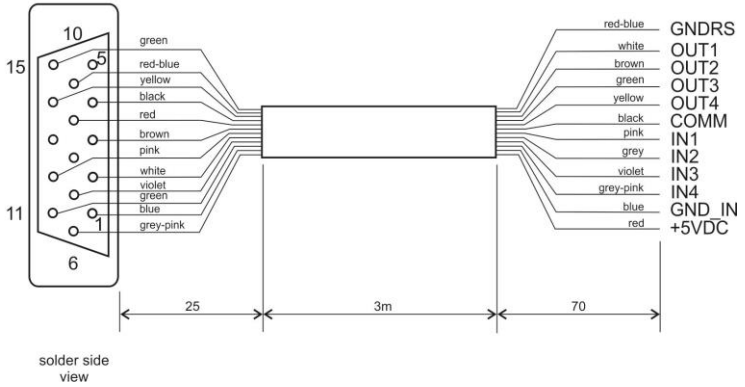













I/O cable



„Scale-Ethernet“ cable is a standard network cable terminated with RJ45 connectors on both ends.

12. ERROR MESSAGES

<p>Error</p>  <p>Zeroing out of range. Use tarring button or restart balance</p> 	<p>Error</p>  <p>Tarring out of range. Use zeroing button or restart balance</p> 
<p>Error</p>  <p>Maximum measuring range exceeded</p> 	<p>Error</p>  <p>Zeroing / Tarring process timeout. Weighing result is not stabilized</p> 
<p>Error</p>  <p>Start mass out of range. Remove load from weighing pan</p> 	<p>Error</p>  <p>Zero value from A/D converter</p> 



RADWAG BALANCES AND SCALES
ADVANCED WEIGHING TECHNOLOGIES

