



Model 201 Weight Transmitter



Installation, Technical and Operation Manual

(Includes 201ADMIX Weight-Based Admix Dispensing System)

Introduction

Thank you for selecting and purchasing the Cardinal Model 201 Weight Transmitter. The Model 201 was built with quality and reliability and incorporates the latest in digital technology and innovative features for the weighing industry. Configuration and upgrades can easily be performed in the field, while still maintaining the rigid control the most demanding installations require. This flexibility insures the Model 201 will be able to meet your weight indicating needs for years to come.

The purpose of this manual is to provide you with a guide through installation, setup and operation of your new Model 201 Weight Transmitter. Please read it thoroughly before attempting to install your weight transmitter and keep it handy for future reference

Copyright



All rights reserved. Reproduction or use, without expressed written permission, of editorial or pictorial content, in any manner, is prohibited. No patent liability is assumed with respect to the use of the information contained herein.

Disclaimer

While every precaution has been taken in the preparation of this manual, the Seller assumes no responsibility for errors or omissions. Neither is any liability assumed for damages resulting from use of the information contained herein. All instructions and diagrams have been checked for accuracy and ease of application; however, success and safety in working with tools depend to a great extent upon the individual accuracy, skill and caution. For this reason the Seller is not able to guarantee the result of any procedure contained herein. Nor can they assume responsibility for any damage to property or injury to persons occasioned from the procedures. Persons engaging the procedures do so entirely at their own risk.

PRECAUTIONS

Before using this weight transmitter, read this manual and pay special attention to all NOTIFICATION symbols:

	IMPORTANT		ELECTRICAL WARNING		STATIC SENSITIVE
---	------------------	---	-------------------------------	--	-----------------------------

FCC Compliance Statement

This equipment generates uses and can radiate radio frequency and if not installed and used in accordance with the instruction manual, may cause interference to radio communications. It has been tested and found to comply with the limits for a Class A computing device pursuant to Subpart J of Part 15 of FCC rules, which are designed to provide reasonable protection against such interference when operated in a commercial environment. Operation of this equipment in a residential area may cause interference in which case the user will be responsible to take whatever measures necessary to correct the interference.

You may find the booklet “How to Identify and Resolve Radio TV Interference Problems” prepared by the Federal Communications Commission helpful. It is available from the U.S. Government Printing Office, Washington, D.C. 20402. Stock No. 001-000-00315-4.

Proper Disposal

When this device reaches the end of its useful life, it must be properly disposed of. It must not be disposed of as unsorted municipal waste. Within the European Union, this device should be returned to the distributor from where it was purchased for proper disposal. This is in accordance with EU Directive 2002/96/EC. Within North America, the device should be disposed of in accordance with the local laws regarding the disposal of waste electrical and electronic equipment.

It is everyone’s responsibility to help maintain the environment and to reduce the effects of hazardous substances contained in electrical and electronic equipment on human health. Please do your part by making certain that this device is properly disposed of. The symbol shown to the right indicates that this device must not be disposed of in unsorted municipal waste programs.



Caution



CAUTION: RISK OF EXPLOSION IF BATTERY IS REPLACED BY AN INCORRECT TYPE. DISPOSE OF USED BATTERIES ACCORDING TO THE INSTRUCTIONS.

ATTENTION: RISQUE D'EXPLOSION SI LA BATTERIES EST REMPLAC'E PAR UN TYPE INCORRECT. REJETEZ LES BATTERIES UTILISE'ES SELON LES INSTRUCTIONS.

Table of Contents

PRECAUTIONS	I
1. SPECIFICATIONS	1
1.1 Standard Features	2
1.2 Optional Features	2
1.3 Approvals	2
2. PRECAUTIONS	3
2.1 Static Electricity.....	3
3. INSTALLATION	5
3.1 Site Preparation Requirements	5
3.1.1 Environmental.....	5
3.1.2 Electrical Power	6
3.1.3 Electrical Noise Interference.....	7
3.1.4 Transient Suppression.....	7
3.2 Mounting	8
3.3 Connections	9
3.4 Load Cell Connections.....	11
3.5 Load Cell Connections with Over 30 Feet of Cable	12
3.6 Sense and Dead Load Jumpers.....	13
3.7 Serial and Analog I/O Cable Installation	15
3.8 ISO I/O Cable Installation	17
3.9 Power Cable Installation	19
4. WEIGHT TRANSMITTER SETUP (Metrological Parameters)	21
4.1 Calibration Switch	21
4.2 Calibration Data Entry.....	22
4.3 Accessing Setup	23
4.4 Setup Mode.....	25
4.5 Scale Configuration.....	27
4.6 STABLESENSE® Digital Filtering.....	31
4.7 Calibration.....	33
4.7.1 Single Point Calibration	34
4.7.2 Multi-Point Calibration.....	35
4.7.3 Span Only Calibration (False Zero)	37
4.8 Fine Span Adjustment.....	39

5. WEIGHT TRANSMITTER SETUP (Non-Metrological Parameters)	41
5.1 Accessing Non-Metrological Parameters	41
5.2 Set Date and Time	43
5.3 Event Counter	45
5.4 Consecutive Number and Accumulators	47
5.5 Preferences	49
5.6 Serial Port	53
5.7 Ethernet Port	59
5.8 USB Port	71
5.9 Analog Input/Output	75
5.10 Digital Input/Output	79
5.11 Optional Memory Card	83
5.12 Enable Check Weighing	85
5.13 Enable Flow Rate	89
5.14 Enable Digital Fill Control	91
5.14.1 Web Page Configuration	95
5.15 Printer Codes	97
5.16 Print Tabs	99
5.17 Test	103
5.18 Display High Resolution Weight	105
6. WEIGHT TRANSMITTER SETUP REVIEW	107
6.1 Accessing Setup Review	107
7. KEYPAD	109
7.1 Standard Key Functions	109
8. ANNUNCIATORS	113
8.1 Annunciators	113
9. ERROR AND STATUS MESSAGES	117
9.1 Before You Call Service	117
9.2 Error and Status Codes	118
10. EVENT COUNTERS	119
10.1 Accessing the Event Counters	120
11. DIGITAL FILL CONTROL	121
11.1 Operation	121
11.2 Output Assigning	122
11.3 Communication Port Control	123

12. 201 ADMIX SYSTEM	127
12.1 Introduction	127
12.2 Setup and Configuration	127
12.3 Web Page Configuration	132
12.4 Operation	136
12.5 Communication Port Control	137
13. LEAD AND WIRE SECURITY SEAL INSTALLATION	139
14. DIAGNOSTICS WEB PAGE	141
14.1 Steps to Import.....	141
14.2 Steps to Export	141
14.3 Steps to Reset to Factory Defaults	141
15. PARTS IDENTIFICATION	143
15.1 Parts List (All Views)	143
15.1.1 201 Terminal Block Connectors*	143
15.2 Front and Back Views	144
15.3 Side and End Views	145
15.4 Internal Views	146

1. SPECIFICATIONS

Power Requirements:	12-24 VDC @ 6w
Listed Accessory:	The weight transmitter is intended to be used with Listed Information Technology Equipment.
Enclosure Rating:	IP-20 DIN Rail 35mm, mounted in customers' enclosure with optional remote display mounting.
Enclosure Size:	4" W x 4.2" H x 1.9" D without connectors. (101.6mm W x 106.7mm H x 48.3mm D)
Operating Environment:	Temperature: 14 to 104 °F (-10 to +40 °C)
Display Capacity:	Six digit, 7-segment, 0.5 inch high with Separate annunciators, Over, Under and Accept backlight indicators
Display Technology:	Transflective LCD with RGB LED backlight
Load Cell Excitation:	11.72 VDC
Signal Input Range:	0.5 mV min. to 35 mV max.
Load Cell Connection:	4 or 6 wire (remote excitation sensing)
Minimum Cell Resistance:	43.75 ohms (8 – 350 ohm cells)
Division Value	
Commercial:	1, 2, 5, 10, 20 or 50 x 10, 1, 0.1, 0.01, 0.001
Non-commercial:	0 to 99
Sensitivity:	0.5 uV / scale division
Resolution:	10,000 divisions
Sample Rate:	1 to 200 samples per second, selectable
Zero Range:	+/-2% to 100% full scale, selectable
Units of Measure:	Pounds, Ounces, Kilograms, Grams
Keys:	Six, membrane type
Serial Interface:	Bi-directional software selectable RS232 (30ft/10m up to 19.2k baud) OR RS485 – 3,300ft/ 1000m, 24 AWG shielded & twisted cable
USB:	5-pin mini USB device
Ethernet:	10/100 Ethernet (DHCP, TCP/IP, Embedded Web Page, Modbus TCP, Ethernet IP)
Inputs:	4 Isolated inputs, 12-24 VDC current sink
Outputs:	4 Isolated outputs, 12-24 VDC current sink

Analog Input:	Software selectable Non-isolated 0-10 VDC or 4-20mA DC
Analog Output:	(1) Non-isolated 0-10 VDC output (12 bit, 2k ohm min.) (1) Non-isolated 4-20mA DC output (12 bit, 450 ohm max.)

1.1 Standard Features

Push button tare function

Gross, tare, net conversion

Hi-Resolution mode

StableSENSE^{®1} adjustable digital filtering

Gross and Net accumulators

Single serial port

Remote input line for Zero, Tare, Gross and Print (1000 feet maximum)

SMA level 2 compliant serial communications (For more information see <http://www.scalemanufacturers.org>)

Field re-programmable via PC interconnection

Test feature (performs display)

1.2 Optional Features

Remote Display

1.3 Approvals

Class III NTEP – Certificate of Conformance No. 13-028

Class III Measurement Canada – Approval No. AM-5904C

¹ StableSENSE[®] is a digital filter utilizing proprietary software algorithms to remove or greatly reduce changes in the weight display resulting from movement on the scale platform. StableSENSE[®] can be used to lessen the effects of movement on the scale or to lessen the effects of wind and vibration. Any application affected by vibration or movement on the scale platform can benefit using StableSENSE[®].

2. PRECAUTIONS

2.1 Static Electricity



CAUTION! This device contains static sensitive circuit cards and components. Improper handling of these devices or printed circuit cards can result in damage to or destruction of the component or card. Such actual and/or consequential damage **IS NOT** covered under warranty and is the responsibility of the device owner. Electronic components must be handled only by qualified electronic technicians who follow the guidelines listed below.



WARNING! ALWAYS use a properly grounded wrist strap when handling, removing or installing electronic circuit cards or components. Make certain that the wrist strap ground lead is securely attached to an adequate ground. If you are uncertain of the quality of the ground, you should consult a licensed electrician.



IMPORTANT! ALWAYS handle printed circuit card assemblies by the outermost edges. NEVER touch the components, component leads or connectors. ALWAYS observe warning labels on static protective bags and packaging and never remove the card or component from the packaging until ready for use. ALWAYS store and transport electronic printed circuit cards and components in anti-static protective bags or packaging.

3. INSTALLATION

3.1 Site Preparation Requirements

The Cardinal Model 201 Weight Transmitter is a precision weight-measuring instrument. As with any precision instrument, it requires an acceptable environment to operate at peak performance and reliability. This section is provided to assist you in obtaining such an environment.

3.1.1 Environmental

The Model 201 Weight Transmitter is supplied as open-type equipment. It must be mounted within an enclosure that is suitably designed for those specific environmental conditions that will be present and appropriately designed to prevent personal injury from accessibility to live parts.

The weight transmitter meets or exceeds all certification requirements within a temperature range of 14 to 104 °F (-10 to +40 °C).

In order to keep cooling requirements to a minimum, the weight transmitter should be placed out of direct sunlight and to provide adequate air circulation, keep the area around it clear.

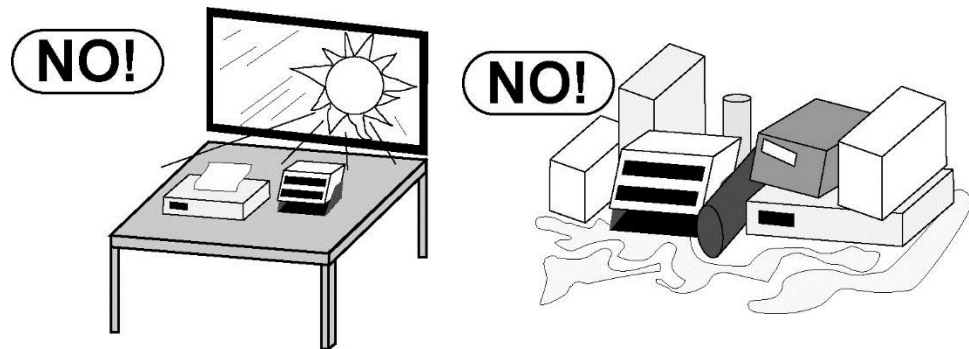

Make certain the weight transmitter is not directly in front of a heating or cooling vent. Such a location will subject the weight transmitter to sudden temperature changes, which may result in unstable weight readings.

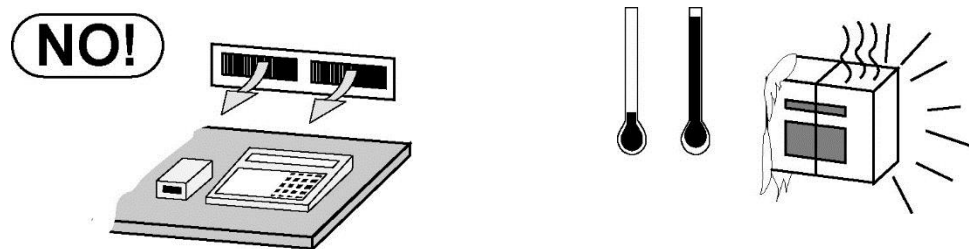

Insure that the weight transmitter has good, clean AC power and is properly grounded. In areas subject to lightning strikes, additional protection to minimize lightning damage, such as surge suppressors, should be installed.

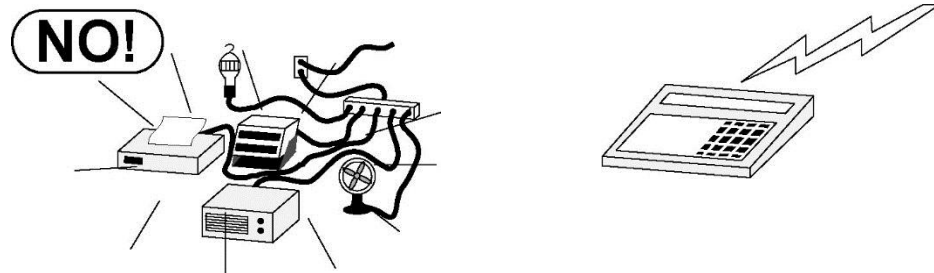

3.1.2 Electrical Power

The Model 201 Weight Transmitter has been designed to operate from 12 to 24 VDC @ 6W. The weight transmitter is intended to be used with Listed Information Technology Equipment.

The power supply to the weight transmitter should be on a separate circuit from the distribution panel and dedicated to the exclusive use of the weight transmitter.

The panel installer must provide electrical protection for the weight transmitter.

The wiring should conform to national and local electrical codes and ordinances and should be approved by the local inspector to assure compliance.

The DIN rail that the weight transmitter enclosure is attached to must be grounded to the sub-panel. If not, then a single wire from the weight transmitter enclosure back to the earth ground terminal block of the cabinet is required.

3.1.3 Electrical Noise Interference

To prevent electrical noise interference, make certain all other branch circuits for use with air conditioning and heating equipment, lighting or other equipment with heavily inductive loads, such as welders, motors and solenoids are on circuits separate from the weight transmitter. Many of these disturbances can originate within the cabinet itself and can seriously affect the operation of the instrument. These sources of disturbances must be identified and steps must be taken to prevent possible adverse effects on the instrument. Examples of available alternatives include isolation transformers, power regulators, uninterruptible power supplies, or simple line filters.

3.1.4 Transient Suppression

The following recommendations will help to reduce transients:

- Always use shielded cables to connect signal wires to the weight transmitter.
- Connect the cable shield (weight transmitter end only) to one of the enclosure screws on the weight transmitter. Keep wires that extend beyond the shield as short as possible.
- Do not run load cell or signal cables from the weight transmitter alongside or parallel to wiring carrying AC power. If unavoidable, position the load cell and signal cables a minimum of 24" away from all AC wiring.
- Always use arc suppressors across all AC power relay contacts (see recommendations at www.paktron.com/pdf/Quencharch_QRL.pdf).
- Use zero voltage switching relays, optically isolated if possible.

3.2 Mounting

Before beginning installation of your Model 201 Weight Transmitter, make certain that it has been received in good condition. Carefully remove it from the shipping carton and inspect it for any evidence of damage (such as exterior dents or scratches) that may have taken place during shipment. Keep the carton and packing material for return shipment if it should become necessary. It is the responsibility of the purchaser to file all claims for any damages or loss incurred during transit.

The Model 201 Weight Transmitter is built with a spring-loaded IP20 DIN Rail mounting clip that can be very easily attached and detached from the rail. When on the rail, the clip "grips" the rail on both the top and bottom lips of the rail. No screwdrivers or special tools are required.

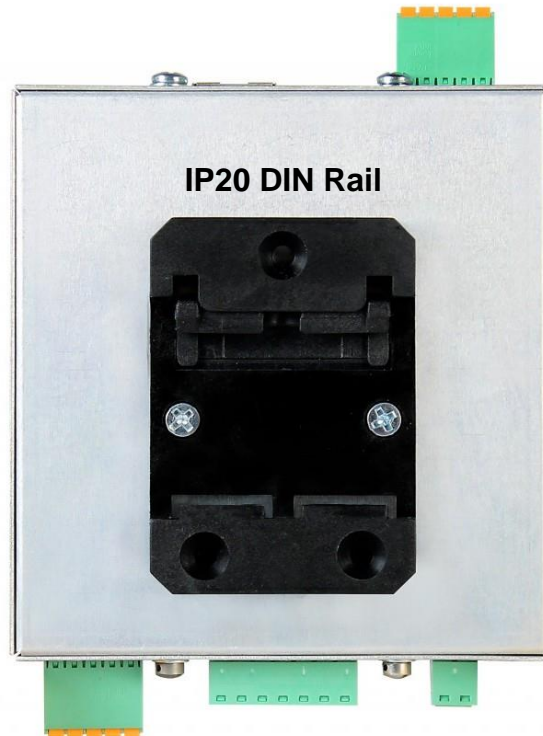

Figure No. 1



WARNING! Make certain the DIN rail that the weight transmitter enclosure is attached to is grounded to the sub-panel. If not, then a single wire from the weight transmitter enclosure back to the earth ground terminal block of the cabinet is required

3.3 Connections

Figure No. 2A

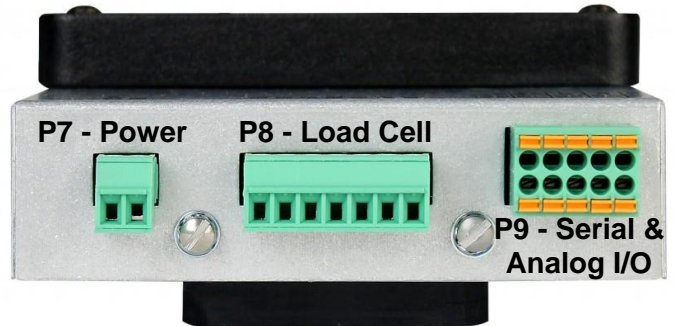
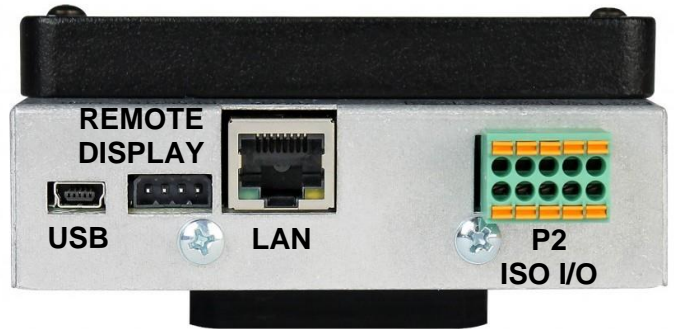
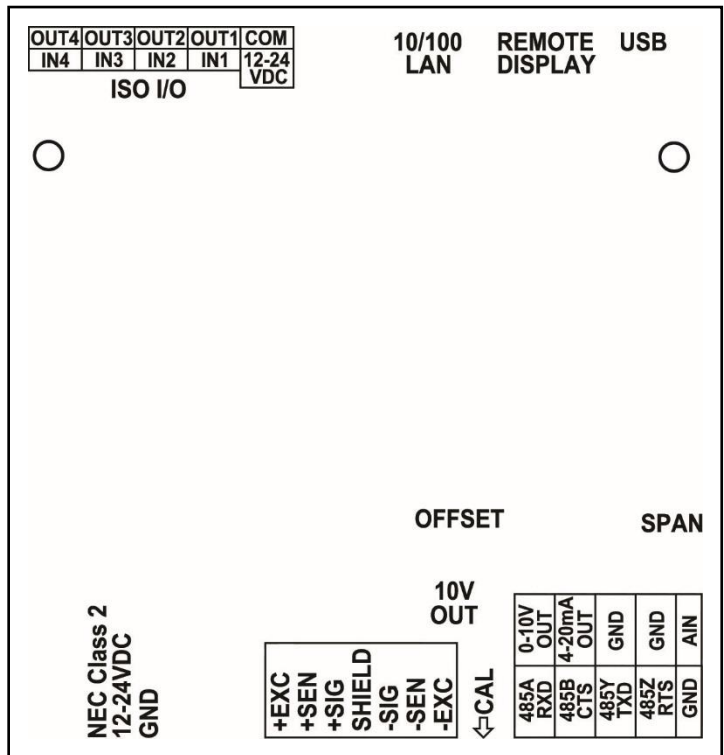

Figure No. 2B



Enclosure Silkscreen



3.4 Load Cell Connections

	<p>WARNING! Disconnect any external load cell power supply before connecting load cells to the weight transmitter. Failure to do so will result in permanent damage to the weight transmitter.</p>
---	---

- 3.4.1. The LOAD CELL wires are to be connected to the P8 terminal block on the bottom panel of the weight transmitter. Refer to Figure No. 2A for an illustration of the connector layout.
- 3.4.2. Remove the 7-connector load cell terminal block connector from the weight transmitter. Grasp the terminal block connector and lift straight up away from the enclosure.
- 3.4.3. Referring to the table below and the labels on the enclosure for terminal connections, connect each wire to the terminal block.

P8 - Load Cell Wiring Table

Label	Function
+EXC	+ EXCITATION
+SENS	+ SENSE
+SIG	+ SIGNAL
SHIELD	SHIELD (Connect the load cell cable shield wire here).
-SIG	- SIGNAL
-SENS	- SENSE
-EXC	- EXCITATION

- 3.4.4. Remove 2" of the outer insulation jacket then remove 1/4" of insulation from each of the 4 wires and shield (without sense leads) or 6 wires and shield with sense leads.
- 3.4.5. Connect each of the wires to load cell terminal block referring to the labels on the enclosure and the load cell terminal detail view for terminal connections.
- 3.4.6. To terminate a wire, loosen the screws in the terminal block and then insert the wire into the terminal opening. Tighten the screw to secure the wire in place.
- 3.4.7. Repeat the procedure until all wires are in place.

3.5 Load Cell Connections with Over 30 Feet of Cable

For installations with over 30 feet of cable between the weight transmitter and the load cells, sense wires should be used. The sense wires must be connected between the +SENS, -SENS terminals on the weight transmitter and the +EXCITATION, -EXCITATION wires of the load cells or the +SENS, -SENS terminals of the load cell trim board or the section seal trim board.

3.6 Sense and Dead Load Jumpers

J2 (+SEN) and J3 (-SEN) – Sense Jumpers

If the sense leads are NOT used, you must install the +SEN and -SEN jumpers at J2 and J3. These jumpers connect the sense leads to the excitation leads. If sense leads ARE used (as in motor truck scales or installations with over 30 feet between the weight transmitter and load cells), these jumpers should be open (on one pin only) or removed. See Figure No. 3 below.

J1 (DEAD LOAD) – Dead Load Boost Jumper

For scales with very low dead loads (less than 10% of the combined load cell capacity), connect the DEAD LOAD (dead load boost) jumper J1. See Figure No. 3 below.

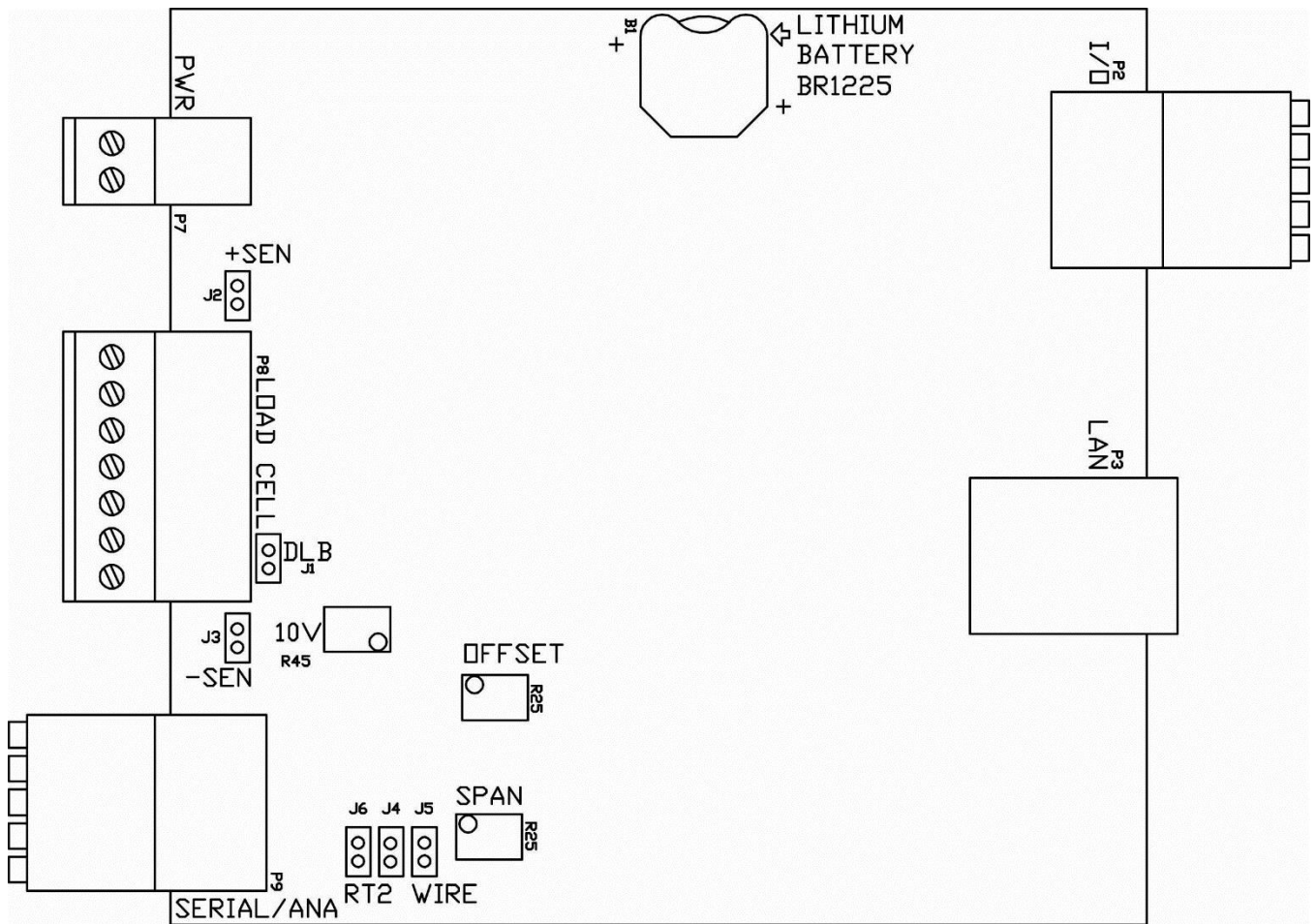

Figure No. 3

3.7 Serial and Analog I/O Cable Installation

- 3.7.1. The SERIAL and ANALOG I/O wires are to be connected to the P9 terminal block on the bottom panel of the weight transmitter. Refer to Figure No. 2A for an illustration of the connector layout.
- 3.7.2. Remove the 10-connector terminal block connector from the weight transmitter. Grasp the terminal block connector and lift straight up away from the enclosure.
- 3.7.3. Referring to the table below and the labels on the enclosure for terminal connections, connect each wire to the terminal block.
- 3.7.4. Remove 2" of the outer insulation jacket then remove 1/4" of insulation from each of the wires.
- 3.7.5. To terminate a wire, push down on the orange spring loaded plunger and then insert the wire into the terminal opening. Release the plunger to secure the wire in place.
- 3.7.6. Repeat the procedure until all wires are in place.

P9 – Serial and Analog I/O Wiring Table
(Note: Must Select RS-232 or RS-485 in Serial Port Mode)

Terminal	Function	Terminal	Function
1	0-10V OUT	6	485A / RX-
2	4-20ma OUT	7	485B / CT+
3	GND	8	485Y / TX-
4	GND	9	485Z / RT+
5	AIN	10	GND

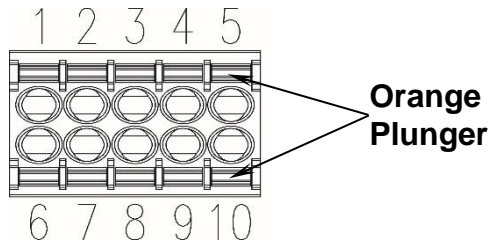

P9 Terminal Block Connector
CPN - 6610-1548

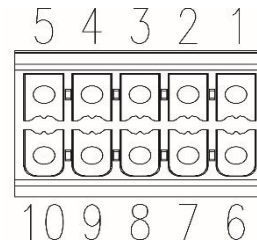

P9 Socket

RS-232 Connections

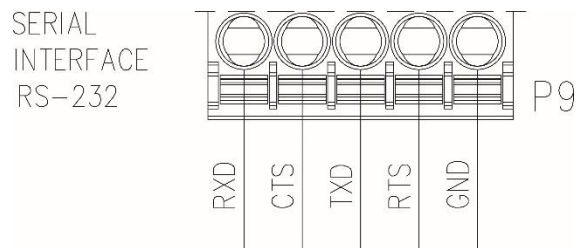

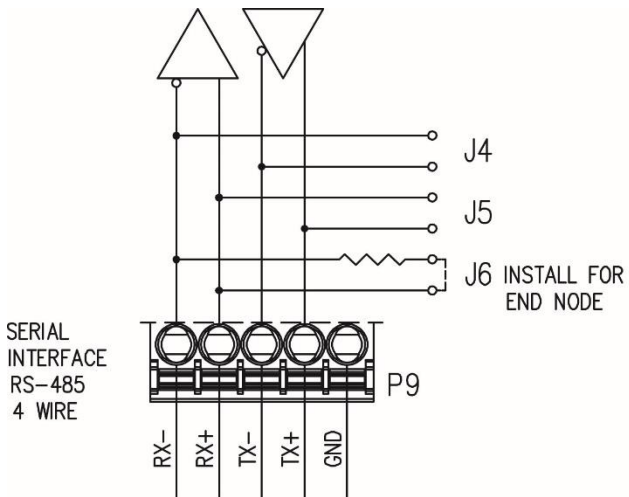

RS-485 4-Wire Connections

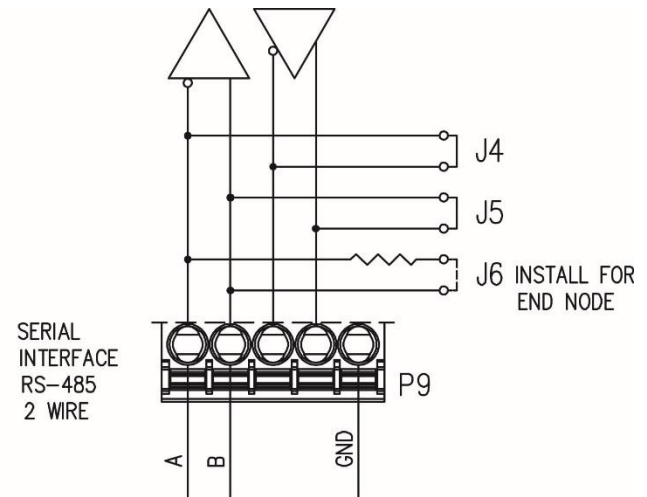

RS-485 2-Wire Connections

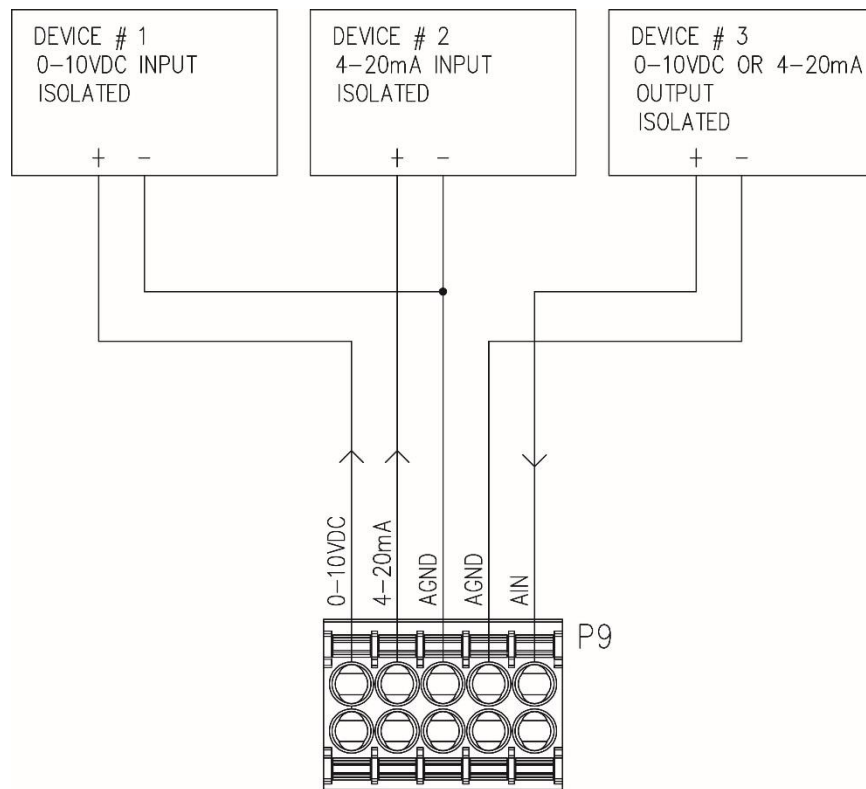

Analog I/O Connections

3.8 ISO I/O Cable Installation

- 3.8.1. The ISO I/O wires are to be connected to the P2 terminal block on the bottom panel of the weight transmitter. Refer to Figure No. 2B for an illustration of the connector layout.
- 3.8.2. Remove the 10-connector terminal block connector from the weight transmitter. Grasp the terminal block connector and lift straight up away from the enclosure.
- 3.8.3. Referring to the table below and the labels on the enclosure for terminal connections, connect each wire to the terminal block.
- 3.8.4. Remove 2" of the outer insulation jacket then remove 1/4" of insulation from each of the wires.
- 3.8.5. To terminate a wire, push down on the orange spring loaded plunger and then insert the wire into the terminal opening. Release the plunger to secure the wire in place.
- 3.8.6. Repeat the procedure until all wires are in place.

P2 – ISO I/O Wiring Table

Terminal	Function	Terminal	Function
1	12-24 VDC	6	COM
2	IN1	7	OUT1
3	IN2	8	OUT2
4	IN3	9	OUT3
5	IN4	10	OUT4

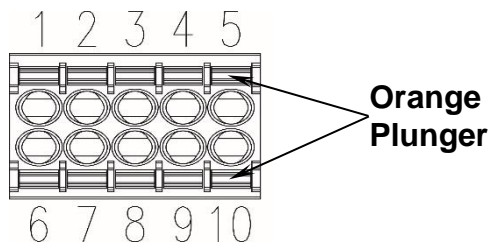

**P2 Terminal Block Connector
CPN - 6610-1548**

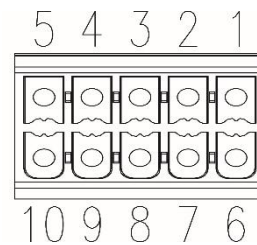

P2 Socket

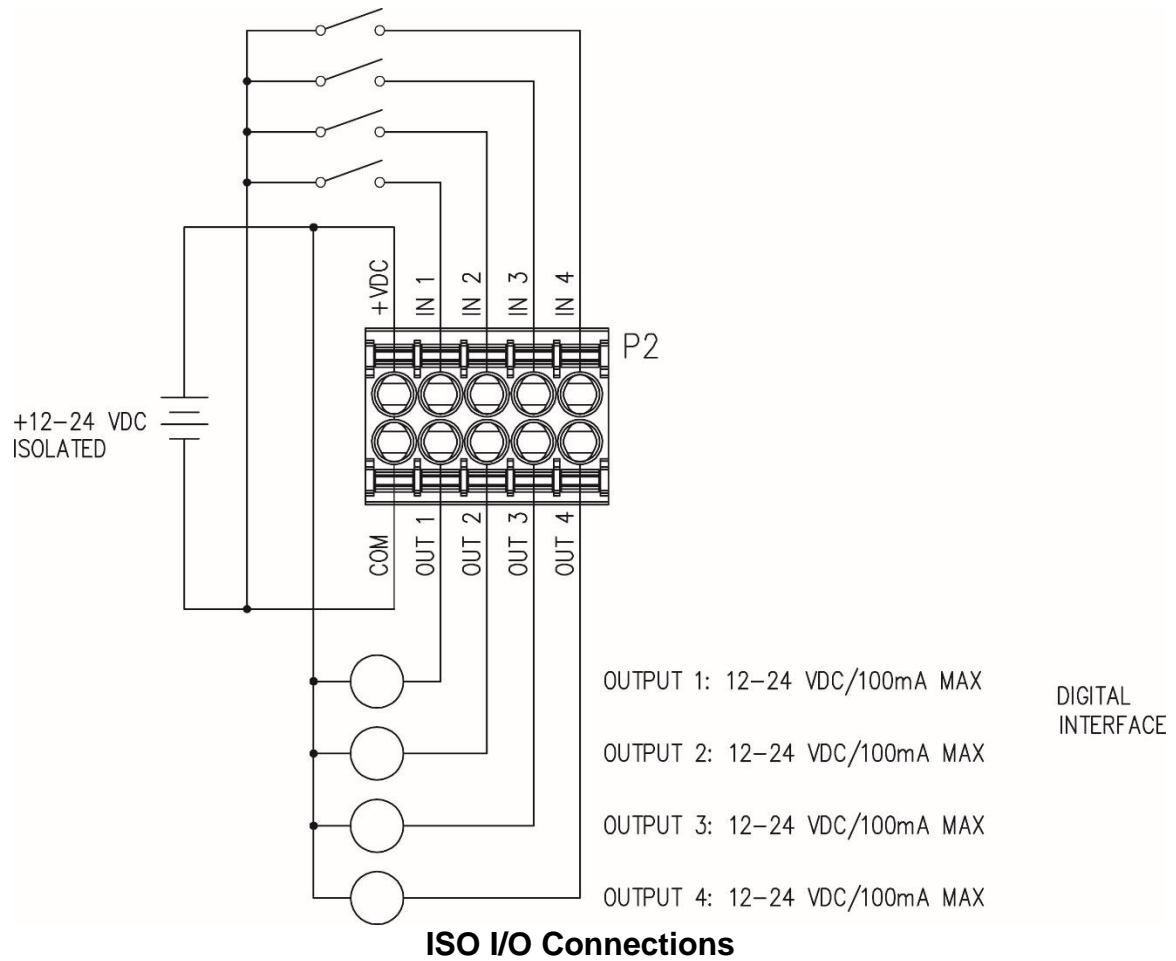

3.9 Power Cable Installation

- 3.9.1. The POWER CABLE wires are to be connected to the P7 terminal block on the bottom panel of the weight transmitter. Refer to Figure No. 2A for an illustration of the connector layout.
- 3.9.2. Remove the 2-connector terminal block connector from the weight transmitter. Grasp the terminal block connector and lift straight up away from the enclosure.
- 3.9.3. Referring to the table below and the labels on the enclosure for terminal connections, connect each wire to the terminal block.
- 3.9.4. Remove 2" of the outer insulation jacket then remove 1/4" of insulation from each of the wires.
- 3.9.5. To terminate a wire, loosen the screws in the terminal block and then insert the wire into the terminal opening. Tighten the screw to secure the wire in place.
- 3.9.6. Repeat the procedure until all wires are in place.

P7 - Power Cable Wiring Table

Terminal	Function
1	12-24 VDC +
2	GND

4. WEIGHT TRANSMITTER SETUP (Metrological Parameters)

4.1 Calibration Switch

Your Model 201 weight transmitter has been thoroughly tested and calibrated before being shipped to you. If you received the weight transmitter attached to a scale, calibration is not necessary. If the weight transmitter is being connected to a scale for the first time or recalibration is necessary for other reasons, proceed as indicated.

The calibration switch is located on the main printed circuit board and can **only** be accessed by removing the screw below and to the right of the load cell connector. Refer to Figure No. 4.

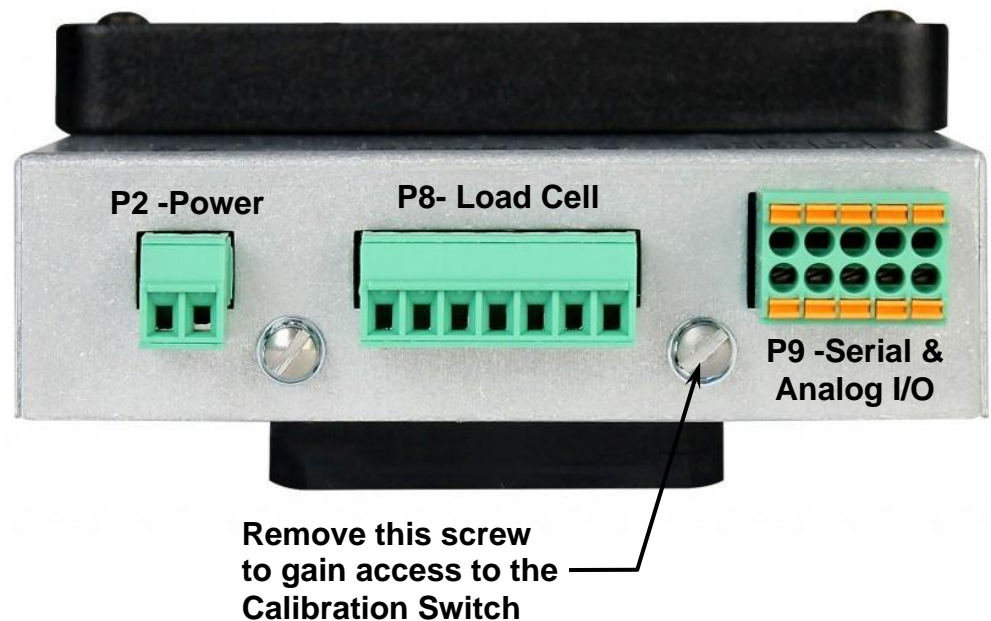

Figure No. 4

4.2 Calibration Data Entry



DO NOT operate the keypad with pointed objects (pencils, pens, etc.). Damage to keypad resulting from this practice is **NOT** covered under warranty.

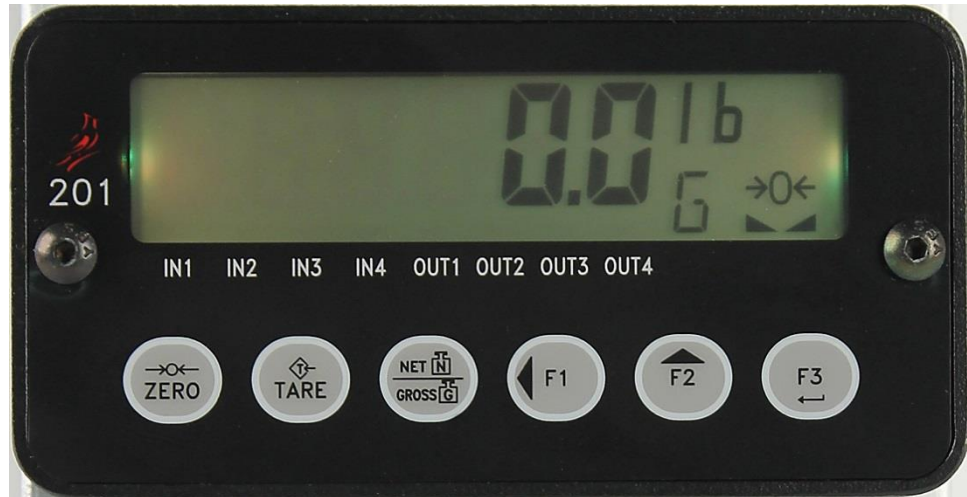

Figure No. 5

During the weight transmitter setup and calibration process it will be necessary to enter operational parameters via the 201 keypad.

- Pressing the **F3/ ←** key will cause the data entered or displayed to be retained and the 201 to advance to the next prompt.
- The functions of numeric keys are replaced by using the **F1/◀** and the **F2/▲** keys.
- The cursor location is identified by the blinking character and can be advanced to the left to the next position by pressing the **F1/◀** key.
- Pressing the **F2/▲** key will change the blinking character to the next value or setting. Continue to press this key to "toggle" between the different available values or settings for the setup parameter.
- Pressing the **F1/◀** key when a setup parameter (not a parameter value or setting) is displayed, will "backup" to the previous parameter prompt.
- Pressing the **F1/◀** key and the **F2/▲** key simultaneously when a setup parameter (not a parameter value or setting) is displayed, will "exit" setup.

4.3 Accessing Setup

- 4.3.1. With the screw removed to gain access to the calibration switch, apply power to the 201 Weight Transmitter.
- 4.3.2. Insert a small tool (e.g. a 3/32 or 2 mm Hex Key Wrench) into the hole where the screw was removed until it contacts the calibration switch.
- 4.3.3. Press and hold the calibration switch for approximately 2 seconds until the display changes to *SETUP*.
- 4.3.4. Release the calibration switch to begin setup.
- 4.3.5. Press the **F2/▲** key to step to the beginning point of each setup section.

<i>SETUP</i>	Setup Mode (starts at <i>USR=</i> prompt)
<i>SCALE</i>	Scale Configuration (starts at <i>Unit =</i> prompt)
<i>FILTER</i>	Analog to Digital Filtering (starts at <i>FLT=</i> prompt)
<i>CAL</i>	Calibration (starts at <i>CAL=</i> prompt)
<i>FSPAN</i>	Fine Span Adjustment

- 4.3.4 If you press the **F3/↵** key at the *SETUP* prompt, you may proceed through to the next section (up to and including *FSPAN*) by pressing the **F3/↵** key.

4.4 Setup Mode

SEtUP

With *SEtUP* displayed, press the **F3/ ↵** key. The display will change to *USR:*. Proceed to the *USR:* (Domestic of International) parameter.

USR: (Domestic or International)

With *USR:* displayed, press the **F3/ ↵** key to show the current setting. If the setting displayed is acceptable, press the **F3/ ↵** key again to save it. Otherwise, use the **F2/ ▲** key to toggle to a new setting and then press the **F3/ ↵** key to save it.

YES (Domestic)

trL: (4% Zero Range) = no
CRP (Capacity) = + 4% to OC
 Date Format = MM/DD/YY

no (International)

trL: (4% Zero Range) = yes
CRP (Capacity) = + 9 grads to OC
 Date Format = DD/MM/YY

LFL: (Legal For Trade)

Press the **F3/ ↵** key to show the current setting. If the setting displayed is acceptable, press the **F3/ ↵** key again to save it. Otherwise, use the **F2/ ▲** key to toggle to a new setting and then press the **F3/ ↵** key to save it.

YES (Legal For Trade)

Interval Settings (*Int:*) allowed are: 1, 2, 5, 10, 20, 50

no (NOT Legal For Trade)

Interval Setting (*Int:*) is selectable from 1 to 99.

When both *LFL: YES* and *USR: YES*, the followings results occur:

Scale must have between 100 and 10,000 divisions

Inhibit serial data during input

trR: (Zero Tracking Range) = 0.5 or 0 to 3

trL: (4% Zero Range) = no

CRP (Capacity) = + 4% to OC

When *LFL: YES* and *USR: no*, the followings results occur:

UnS: (Motion Range) = 1

trL: (4% Zero Range) = yes

CRP (Capacity) = + 9 grads to OC

4.5 Scale Configuration

SCALE

With *SCALE* displayed, press the **F3/ ←** key. The display will change to *Unit 1:*. Proceed to the *Unit 1:* (Weighing Unit 1) parameter.

Unit 1: (Weighing Unit 1)

With *Unit 1:* displayed, press the **F3/ ←** key to show the current setting. If the setting displayed is acceptable, press the **F3/ ←** key again to save it. Otherwise, use the **F2/ ▲** key to toggle to a new setting and then press the **F3/ ←** key to save it. Allowable settings are:

1 lb = pounds 2 kg = kilograms 3 oz = ounces
 4 g = grams

Int: (Interval Setting)

Press the **F3/ ←** key to show the current setting.

If *Int = YES*, use the **F2/ ▲** key to toggle to a new setting and then press the **F3/ ←** key to save it. Allowable settings are: 1, 2, 5, 10, 20 or 50.

If *Int = NO*, use the **F2/ ▲** and **F1/ ◀** keys to enter a new setting and then press the **F3/ ←** key to save it. Allowable settings are: 1 through 99.

When the setting displayed is acceptable, press the **F3/ ←** key again to save it.

dPP: (Decimal Point Setting)

Press the **F3/ ←** key to show the current setting. If the setting displayed is acceptable, press the **F3/ ←** key again to save it. Otherwise, use the **F2/ ▲** key to toggle to a new setting and then press the **F3/ ←** key to save it. Allowable settings are:

0 = X X X X X X 1 = X X X X X . X
 2 = X X X X . X X 3 = X X X . X X X

NOTE: The Decimal Point Setting prompt will not be shown if the Interval Setting is 10 or greater.

CAP = (Capacity)

Press the **F3/ ↵** key to show the current setting. If the setting displayed is acceptable, press the **F3/ ↵** key again to save it. Otherwise, use the **F2/ ▲** and **F1/ ◀** keys to enter a new setting and then press the **F3/ ↵** key to save it. Allowable capacity settings are: 1 through 999,999.

NOTE: When entering the capacity setting, the cursor location is identified by the blinking character and can be advanced to the left to the next position by pressing the **F1/ ◀** key. Pressing the **F2/ ▲** key will change the blinking character to the next value. When the last digit of the capacity setting has been entered, press the **F3/ ↵** key. The blinking character will index to the “right”. Continue to press the **F3/ ↵** key to verify each digit of the capacity setting until the display changes to the *Unit 2 =* prompt.

Unit 2 = (Weighing Unit 2)

Press the **F3/ ↵** key to show the current setting. If the setting displayed is acceptable, press the **F3/ ↵** key again to save it. Otherwise, use the **F2/ ▲** key to toggle to a new setting and then press the **F3/ ↵** key to save it. Allowable settings are:

- | | | |
|---------------|------------------|---------------|
| 1 lb = pounds | 2 kg = kilograms | 3 oz = ounces |
| 4 g = grams | none = none | |



NOTE: The selection for *Unit 2* cannot be the same as *Unit 1*. In addition, dependent upon the selection for *Unit 1*, the interval and decimal point settings, not all unit combinations are available.

Scale Input = (Scale Input)

Press the **F3/ ↵** key to show the current setting. If the setting displayed is acceptable, press the **F3/ ↵** key again to save it. Otherwise, use the **F2/ ▲** key to toggle to a new setting and then press the **F3/ ↵** key to save it.

- | | |
|-------------------------------------|--|
| 0 = Scale Input
(P8 - Load Cell) | 1 = Analog Input
(P9 - AIN and GND) |
|-------------------------------------|--|

ERR = (4% Zero Range)

Press the **F3/ ←** key to show the current setting. If the setting displayed is acceptable, press the **F3/ ←** key again to save it. Otherwise, use the **F2/ ▲** key to toggle to a new setting and then press the **F3/ ←** key to save it.

YES

4% of scale capacity

NO

Full capacity (no limit)

CALPT = (Number of Calibration Points)

Calibration of the weight transmitter can be performed using multiple calibration points to obtain a more precise weight reading over the entire span of the scale.

Press the **F3/ ←** key to show the current setting. If the setting displayed is acceptable, press the **F3/ ←** key again to save it. Otherwise, use the **F2/ ▲** key to toggle to a new setting and then press the **F3/ ←** key to save it. Allowable values are **1** to **4**.



NOTE: The **CALPT =** parameter is used to set the calibration points in addition to the zero (no load) weight calibration point. **DO NOT** include the zero (no load) weight calibration point when selecting the number of calibration points. For example, selecting 2 for the **CALPT =** parameter, you would have a total of three calibration points, the zero (no load) weight and two calibrations points that could correspond to a mid-point weight and the test (load) weight.

4.6 STABLESENSE® Digital Filtering

F ILT Er

With *F ILT Er* displayed, press the **F3/ ↵** key. The display will change to *FLt =*. Proceed to the *FLt =* (Filter Type) parameter.

FLt = (Filter Type)

With *FLt =* displayed, press the **F3/ ↵** key to show the current setting. If the setting displayed is acceptable, press the **F3/ ↵** key to save it. Otherwise, use the **F2/ ▲** key to toggle to a new setting and then press the **F3/ ↵** key to save it. Note, that if you select IIR or FIR two additional prompts will be displayed. Allowable settings are:

<i>off</i>	OFF	Disabled, Filter configuration off
<i>min</i>	min	Minimal Filtering
<i>mod</i>	mod	Moderate Filtering
<i>iir</i>	IIR	Infinite Impulse Response – (slower response but better for higher capacity scales)
<i>fir</i>	FIR	Finite Impulse Response – (faster response, better for filtering out vibration)



NOTE: The prompts, *b =* (Break Range) and *F =* (Filter Level) will only be displayed if you selected IIR or FIR for the *FLt =* (Filter Type) prompt.

b = (Break Range)

The break range is a number from 1 to 255 that corresponds to the number of division change to break out of the filtering. Press the **F3/ ↵** key to show the current setting for the break range. To keep the displayed setting, press the **F3/ ↵** key. Otherwise, use the **F2/ ▲** and **F1/ ◀** keys to enter a new setting and then press the **F3/ ↵** key to save it. Allowable values for break range are: 1 through 255.

F = (Filter Level)

The filter level is a number from 1 to 99 that corresponds to the level of filtering with 1 being the least and 99 being the greatest. Press the **F3/ ↵** key to show the current setting. To accept the setting displayed, press the **F3/ ↵** key again to save it. Otherwise, use the **F2/ ▲** and **F1/ ◀** keys to enter a new setting and then press the **F3/ ↵** key to save it. Allowable values for filter level are: 1 through 99.

5r = (Sample Rate)

Press the **F3/ ↵** key to show the current setting for the sample rate. The setting displayed is the sample rate in samples per second. Press the **F3/ ↵** key to save the displayed setting or use the **F2/▲** and **F1/◀** keys to enter a new setting and then press the **F3/ ↵** key to save it. Allowable values for sample rate are: 0 through 200 samples.

Un5 = (Motion Range)

Press the **F3/ ↵** key to view the current setting for the range of motion detection. If the displayed setting is acceptable, press the **F3/ ↵** key to save it. Otherwise, use the **F2/▲** and **F1/◀** keys to enter a new range (the number of divisions of change permitted before indicating unstable) and then press the **F3/ ↵** key to save the new setting. Allowable values for motion range are: 0 through 99 divisions.

5C = (Stable Count)

Press the **F3/ ↵** key to view the current setting for the number of consecutive stable weight readings before indicating stable weight. This helps filter weight readings for stability when trying to capture stable weight. If the displayed setting is acceptable, press the **F3/ ↵** key to save it. Otherwise, use the **F2/▲** and **F1/◀** keys to enter a new setting and press the **F3/ ↵** key to save the new setting. Allowable values for the stable count are: 1 through 255.

zrR = (Zero Tracking)

Press the **F3/ ↵** key to show the current setting assigned to the Automatic Zero Tracking Range. This is the value in scale divisions that will be automatically zeroed off. If the setting displayed is acceptable, press the **F3/ ↵** key again to save it. Otherwise, use the **Fn/▲** key to toggle to a new setting and then press the **F3/ ↵** key to save it. Allowable values are: OFF (OFF = disables Zero Tracking), 0.5, or 1 through 9. **NOTE:** Zero Tracking maximum of 3 if Legal For Trade.

4.7 Calibration

CAL

With *CAL* displayed, press the **F3/↵** key. The display will change to *CAL =*. Proceed to the *CAL =* (Perform Calibration) parameter.

CAL = (**Perform Calibration**)

With *CAL =* displayed, press the **F3/↵** key. The display will change to *no*. If scale has been previously calibrated and you wish to skip calibration and proceed to *F SPAN*, press the **F3/↵** key again.

Otherwise, press the **F2/▲** key to toggle to *YES* and then press the **F3/↵** key. The display will change to *CAL 1 =*. Proceed to the *CAL 1 =* parameter.

During calibration it will be necessary to enter values using the 201 keypad.

Pressing the **F3/↵** key will cause the data entered or displayed to be retained and the 201 to advance to the next prompt.

The functions of numeric keys are replaced by using the **F1/◀** and the **F2/▲** keys.

The cursor location is identified by the blinking character and can be advanced to the left to the next position by pressing the **F1/◀** key.

Pressing the **F2/▲** key will change the blinking character to the next value.

4.7.1 Single Point Calibration

CAL 1= – First Calibration Weight

1. The display will show *CAL 1=*. This is the first of two calibration weights. This weight could be ZERO (NO LOAD) or the TEST WEIGHTS (TEST LOAD).
2. Press the **F3/ ↵** key to view the current setting.
3. If the first calibration weight is to be ZERO (NO LOAD), press the **F3/ ↵** key.
4. If the first calibration weight is to be the TEST WEIGHTS (TEST LOAD), use the **F1/◀** and **F2/▲** keys to input the value of the test weights.
5. Place the weights on the scale platform, then press the **F3/ ↵** key.
6. Starting at the left and proceeding right, a series of dashes will appear on the display.
7. Next, starting at the left and proceeding right, the dashes will disappear, after which the display will show: *CAL 2=*.

CAL 2= – Second Calibration Weight

1. The display will show *CAL 2=*. This is the second of two calibration weights. This weight could be ZERO (NO LOAD) or the TEST WEIGHTS (TEST LOAD).
2. Press the **F3/ ↵** key to view the current setting.
3. If the second calibration weight is to be ZERO (NO LOAD), press the **F3/ ↵** key.
4. If the second calibration weight is to be the TEST WEIGHTS (TEST LOAD), use the **F1/◀** and **F2/▲** keys to input the value of the test weights.
5. Place the weights on the scale platform, then press the **F3/ ↵** key.
6. Starting at the left and proceeding right, a series of dashes will appear on the display.
7. Next, starting at the left and proceeding right, the dashes will disappear, after which the display will show: *F SPAN*.

4.7.2 Multi-Point Calibration

Up to 5 calibration points (CAL 1= through CAL 5=) may be displayed depending on the value set for the CAL Pt = parameter. Note that one of the weights must be 0 (no load).

NOTE: The following outlines the steps to perform calibration when 2 calibration points have been selected for the CAL Pt = parameter.

CAL 1= – First Calibration Weight

1. The display will show CAL 1=. This is the first of three calibration weights. This weight could be ZERO (NO LOAD) or the TEST WEIGHTS (TEST LOAD).
2. Press the **F3/ ↵** key to view the current setting.
3. If the first calibration weight is to be ZERO (NO LOAD), press the **F3/ ↵** key.
4. If the first calibration weight is to be the TEST WEIGHTS (TEST LOAD), use the **F1/ ◀** and **F2/ ▲** keys to input the value of the test weights.
5. Place the weights on the scale platform, then press the **F3/ ↵** key.
6. Starting at the left and proceeding right, a series of dashes will appear on the display.
7. Next, starting at the left and proceeding right, the dashes will disappear, after which the display will show: CAL 2=.

CAL 2= – Second Calibration Weight

1. The display will show CAL 2=. This is the second of three calibration weights. This weight could be a PARTIAL amount of the TEST WEIGHTS (TEST LOAD).
2. Press the **F3/ ↵** key to view the current setting.
3. If the second calibration weight is to be a PARTIAL amount of the TEST WEIGHTS (TEST LOAD), use the **F1/ ◀** and **F2/ ▲** keys to input the value of the test weights.
4. Place the weights on the scale platform, then press the **F3/ ↵** key.
5. Starting at the left and proceeding right, a series of dashes will appear on the display.
6. Next, starting at the left and proceeding right, the dashes will disappear, after which the display will show: CAL 3=.

CAL3= – Third Calibration Weight

1. The display will show *CAL3=*. This is the third of three calibration weights. This weight could be ZERO (NO LOAD) or the TEST WEIGHTS (TEST LOAD).
2. Press the **F3/ ↵** key to view the current setting.
3. If the third calibration weight is to be ZERO (NO LOAD), press the **F3/ ↵** key.
4. If the third calibration weight is to be the TEST WEIGHTS (TEST LOAD), use the **F1/ ◀** and **F2/ ▲** keys to input the value of the test weights.
5. Place the weights on the scale platform, then press the **F3/ ↵** key.
6. Starting at the left and proceeding right, a series of dashes will appear on the display.
7. Next, starting at the left and proceeding right, the dashes will disappear, after which the display will show: *F SPAN*.

4.7.3 Span Only Calibration (False Zero)

This calibration method calculates a new span while maintaining the zero point. This is useful for tank scales that cannot be fully emptied.

CR1 – Test Load Weight

1. The display will show *CR1*.
2. Place the TEST LOAD on the scale.
3. Use the **F1/◀** and **F2/▲** keys to input the value of the TEST LOAD.
4. Press the **F3/↵** key until calibration starts.
5. Starting at the left and proceeding right, a series of dashes will appear on the display.
6. Next, starting at the left and proceeding right, the dashes will disappear, after which the display will show: *CR2*.

CR2 – False Zero Weight

1. The display will show *CR2*.
2. Remove the TEST LOAD from the scale.
3. Press the **NET/GROSS** key.
4. A new span will be calculated.



NOTE: If the *CRPE* parameter is greater than 1, all other test points will be bypassed for a Span Only calibration.

4.8 Fine Span Adjustment



IMPORTANT! The *F SPAN* mode requires a load of 10% of Capacity on the scale before adjustments can be made.

F SPAN

Fine Span Adjustment (from *SETUP* Prompt)

1. With the *SETUP* prompt displayed, press the **F2/▲** key until the display shows the *F SPAN* prompt.
2. With *F SPAN* displayed, press the **F3/↵** key.
3. The display will change to show *FSPAN=*, press the **F3/↵** key.
4. The display will change to *no*. If you wish to skip fine span adjustment and exit SETUP, press the **F3/↵** key again.
5. Otherwise, place a calibrated test weight on the scale and press the **F2/▲** key to toggle to *YES* and then press the **F3/↵** key.
6. The display will change to show the amount of the test weight, and an *F* will be displayed to the right of the displayed weight.
7. Press the **F2/▲** key to increase the span OR press the **F1/◀** key to decrease the span.
8. Press the **F3/↵** key to exit the Fine Span Adjustment and return to the normal operation mode.

Fine Span Adjustment (after completing calibration step, *CAL2=*)

1. With *F SPAN* displayed, press the **F3/↵** key.
2. The display will change to show *FSPAN=*, press the **F3/↵** key.
3. The display will change to *no*. If you wish to skip fine span adjustment and exit SETUP, press the **F3/↵** key again.
4. Otherwise, place a calibrated test weight on the scale and press the **F2/▲** key to toggle to *YES* and then press the **F3/↵** key.
5. The display will change to show the amount of the test weight, and an *F* will be displayed to the right of the displayed weight.
6. Press the **F2/▲** key to increase the span OR press the **F1/◀** key to decrease the span.
7. Press the **F3/↵** key to exit the Fine Span Adjustment and return to the normal operation mode.

5. WEIGHT TRANSMITTER SETUP (Non-Metrological Parameters)

The Model 201 allows several non-metrological parameters to be reviewed and changed without breaking the calibration seal.

5.1 Accessing Non-Metrological Parameters

1. With the weight transmitter ON, press the **F1/◀** key and the **F2/▲** key simultaneously.
2. The display will change to show *dAtE* (the prompt to set the date and time).
3. Press the **F3/↵** key to show the current setting. If the setting displayed is acceptable, press the **F3/↵** key again to save it. Otherwise, use the **F2/▲** key to toggle to a new setting and then press the **F3/↵** key to save it and advance to the next prompt.
4. To exit press the **F3/↵** key to step through the remaining prompts *OR* at anytime, cycle the power.
5. The weight transmitter will return to the normal weight display.

<i>dAtE</i>	Set Date and Time
<i>EtC</i>	Event Counter (Read Only Values)
<i>ACCURn</i>	Accumulators and Consecutive Number
<i>PrEF</i>	Preferences (Date order, 12 or 24 hour clock , Function key assignments and default background Color
<i>SErIAL</i>	Serial Port Parameters
<i>EtHER</i>	Ethernet Parameters
<i>USb</i>	USB Parameters
<i>AnA io</i>	Analog Input/Output Setup
<i>dLG io</i>	Digital Input/Output Setup
<i>StorE</i>	Optional Memory Card Configuration
<i>oErUnd</i>	Check weighing (over/under) Setup
<i>FLo</i>	Flow Rate Measuring
<i>dFC</i>	Digital Fill Control
<i>PrtCod</i>	Printer Codes
<i>tAbS</i>	Print Tab Settings Configuration
<i>tESt</i>	Test Mode
<i>HirES</i>	Display High Resolution Weight

5.2 Set Date and Time

DATE

With *DATE* displayed, press the **F3/ ↵** key. The display will change to *YEAR =*. Proceed to the *YEAR =* (Year) parameter.

YEAR = (Year)

With *YEAR =* displayed, press the **F3/ ↵** key to show the current setting. To accept the setting displayed, press the **F3/ ↵** key again to save it. Otherwise, use the **F2/▲** and **F1/◀** keys to enter a new setting and then press the **F3/ ↵** key to save it. Allowable values for the year are: 2000 through 9999.

חֶסֶרָה (Month)

With *חֶסֶרָה* displayed, press the **F3/ ↵** key to show the current setting. To accept the setting displayed, press the **F3/ ↵** key again to save it. Otherwise, use the **F2/▲** and **F1/◀** keys to enter a new setting and then press the **F3/ ↵** key to save it. Allowable values for the month are: 1 through 12.

דַּי = (Day)

With *דַּי =* displayed, press the **F3/ ↵** key to show the current setting. To accept the setting displayed, press the **F3/ ↵** key again to save it. Otherwise, use the **F2/▲** and **F1/◀** keys to enter a new setting and then press the **F3/ ↵** key to save it. Allowable values for the day are: 1 through 31.

Hour = (Hour)

With *Hour =* displayed, press the **F3/ ↵** key to show the current setting. To accept the setting displayed, press the **F3/ ↵** key again to save it. Otherwise, use the **F2/▲** and **F1/◀** keys to enter a new setting and then press the **F3/ ↵** key to save it. Allowable values for the hour are: 0 through 23.

דַּקוֹתָה (Minutes)

With *דַּקוֹתָה* displayed, press the **F3/ ↵** key to show the current setting. To accept the setting displayed, press the **F3/ ↵** key again to save it. Otherwise, use the **F2/▲** and **F1/◀** keys to enter a new setting and then press the **F3/ ↵** key to save it and advance to the next parameter prompt. Allowable values for the minutes are: 0 through 59.

5.3 Event Counter

A Category 1 Event Counter is provided on the 201 with two counters that increment when a change is made to features that are required by NTEP or OIML to be sealed. One counter is designated for calibration (metrological) parameters and one is designated for configuration (non- metrological) changes as required in NCWM Publication 14, 2007. Each event counter has a capacity to record 99999 changes. The data for the counters is maintained in non-volatile memory and can be viewed by a weights and measures inspector. When selected, the display will show the number of changes to the Configuration and the Calibration counters.

CF9 = (Configuration Counter)

The configuration counter is incremented when a value in the non-meteorological part of setup is changed. The counter is only incremented 1 time even if more than one parameter is changed each time through setup. The value displayed will be between 0 and 99999.

CAL = (Calibration Counter)

The calibration counter is incremented when a value in the meteorological part of setup is changed. The counter is only incremented 1 time even if more than one parameter is changed each time through setup. The value displayed will be between 0 and 99999.

Etr

1. With *Etr* displayed, press the **F3/ ↵** key. The display will change to *CF9* = (the prompt to view the Configuration Counter).
2. Press the **F3/ ↵** key to show the current value of the configuration counter.
3. Press the **F3/ ↵** key again. The display will change to *CAL* = (the prompt to view the Calibration Counter).
4. Press the **F3/ ↵** key to show the current value of the calibration counter.
5. With the value for the calibration counter displayed, press the **F3/ ↵** key to advance to the next parameter prompt.

5.4 Consecutive Number and Accumulators

ACCUM

With *ACCUM* displayed, press the **F3/ ←** key. The display will change to *CLRA*. Proceed to the *CLRA* (Clear Accumulators) parameter.

CLRA (Clear Accumulators)

With *CLRA* displayed, press the **F3/ ←** key to show the current setting. If the setting displayed is acceptable, press the **F3/ ←** key again to save it. Otherwise, use the **F2/▲** key to toggle to a new setting and then press the **F3/ ←** key to save it.

YES

Gross and Net accumulators
will be cleared (set to zero)

NO

Gross and Net accumulators
will NOT be cleared

CON (Consecutive Number)

With *CON* displayed, press the **F3/ ←** key to show the current setting. To accept the setting displayed, press the **F3/ ←** key again to save it. Otherwise, use the **F2/▲** and **F1/◀** keys to enter a new setting and then press the **F3/ ←** key to save it. Allowable values for consecutive number are: 0 through 999999.

GACC (Gross Accumulator)

With *GACC* displayed, press the **F3/ ←** key to show the current setting. To accept the setting displayed, press the **F3/ ←** key again to save it. Otherwise, use the **F2/▲** and **F1/◀** keys to enter a new setting and then press the **F3/ ←** key to save it. Allowable values for the gross accumulator are: 0 through 999999.

NACC (Net Accumulator)

With *NACC* displayed, press the **F3/ ←** key to show the current setting. To accept the setting displayed, press the **F3/ ←** key again to save it. Otherwise, use the **F2/▲** and **F1/◀** keys to enter a new setting and then press the **F3/ ←** key to save it. Allowable values for the net accumulator are: 0 through 999999.

5.5 Preferences

PREF

With *PREF* displayed, press the **F3/ ↵** key. The display will change to *LANG:*. Proceed to the *LANG:* (Language) parameter.

LANG: **(Language)**

Press the **F3/ ↵** key to show the current setting. If the setting displayed is acceptable, press the **F3/ ↵** key again to save it. Otherwise, use the **F2/▲** key to toggle to a new setting and then press the **F3/ ↵** key to save it. Allowable settings are:

<i>ENG</i>	English
<i>ESP</i>	Spanish

dtord: **(Date Order)**

Press the **F3/ ↵** key to show the current setting. If the setting displayed is acceptable, press the **F3/ ↵** key again to save it. Otherwise, use the **F2/▲** key to toggle to a new setting and then press the **F3/ ↵** key to save it. Allowable settings are:

<i>m-d-y</i>	Month – Day – Year
<i>d-m-y</i>	Day – Month – Year
<i>y-m-d</i>	Year – Month – Day

12hr: **(12 or 24 Time Format)**

Press the **F3/ ↵** key to show the current setting. If the setting displayed is acceptable, press the **F3/ ↵** key again to save it. Otherwise, use the **F2/▲** key to toggle to a new setting and then press the **F3/ ↵** key to save it. Note that in the 24 hour format, 12 is added to all times after noon, i.e. 3 PM would be 1500. Allowable settings are:

<i>125</i>	12 hour clock (3PM displays 3:00)
<i>no</i>	24 hour clock (3PM displays 15:00)

F1: (Function Key 1 Assignment)

Press the **F3/ ←** key to show the current setting. If the setting displayed is acceptable, press the **F3/ ←** key again to save it. Otherwise, use the **F2/▲** key to toggle to a new setting and then press the **F3/ ←** key to save it. Allowable settings are:

<i>oFF</i>	Off (key is disabled)
<i>Un itS</i>	Units (key is used to toggle between weighing units)
<i>Pr int</i>	Print (key is used to transmit data to output port)
<i>dSPCYc</i>	Display Cycle (key is used to toggle between weight, analog to digital voltage, time and date)*

F2: (Function Key 2 Assignment)

Press the **F3/ ←** key to show the current setting. If the setting displayed is acceptable, press the **F3/ ←** key again to save it. Otherwise, use the **F2/▲** key to toggle to a new setting and then press the **F3/ ←** key to save it. Allowable settings are:

<i>oFF</i>	Off (key is disabled)
<i>Un itS</i>	Units (key is used to toggle between weighing units)
<i>Pr int</i>	Print (key is used to transmit data to output port)
<i>dSPCYc</i>	Display Cycle (key is used to toggle between weight, analog to digital voltage, time and date)*

F3: (Function Key 3 Assignment)

Press the **F3/ ←** key to show the current setting. If the setting displayed is acceptable, press the **F3/ ←** key again to save it. Otherwise, use the **F2/▲** key to toggle to a new setting and then press the **F3/ ←** key to save it. Allowable settings are:

<i>oFF</i>	Off (key is disabled)
<i>Un itS</i>	Units (key is used to toggle between weighing units)
<i>Pr int</i>	Print (key is used to transmit data to output port)
<i>dSPCYc</i>	Display Cycle (key is used to toggle between weight, analog to digital voltage, time and date)*

* Display will return to weight mode when power is cycled.

Color: (Default Display Backlight Color)

Press the **F3/ ↵** key to show the current setting. If the setting displayed is acceptable, press the **F3/ ↵** key again to save it. Otherwise, use the **F2/ ▲** key to toggle to a new setting and then press the **F3/ ↵** key to save it. Allowable settings are:

<i>oFF</i>	oFF (display backlight is disabled)
<i>rEd</i>	Red display backlight color
<i>GrEEn</i>	Green display backlight color
<i>YELLo</i>	Yellow display backlight color
<i>bluE</i>	Blue display backlight color
<i>PurPLE</i>	Purple display backlight color
<i>whitE</i>	White display backlight color
<i>Pinc</i>	Pink display backlight color

5.6 Serial Port

SERIAL

With *SERIAL* displayed, press the **F3/ ↵** key. The display will change to *MODE=*. Proceed to the *MODE=* (Serial Port Mode) parameter.

MODE= (Serial Port Mode)

Press the **F3/ ↵** key to show the current setting. If the setting displayed is acceptable, press the **F3/ ↵** key again to save it. Otherwise, use the **F2/▲** key to toggle to a new setting and then press the **F3/ ↵** key to save it. Allowable settings are:

<i>rS 232</i>	RS232 (Serial interface uses RS232 protocols)
<i>rS 485</i>	RS485 (Serial interface uses RS485 protocols)
<i>oFF</i>	Off (Serial interface is disabled)



NOTE: If the Serial Port Mode is enable, the following prompts, Baud Rate, Data bits, Parity, Stop Bits, Weight Mode and Print from Port will be shown.

BAUD= (Baud Rate)

Press the **F3/ ↵** key to show the current setting. If the setting displayed is acceptable, press the **F3/ ↵** key again to save it. Otherwise, use the **F2/▲** key to toggle to a new setting and then press the **F3/ ↵** key to save it. Allowable settings are:

<i>1200</i> = 1200 Baud	<i>2400</i> = 2400 Baud	<i>4800</i> = 4800 Baud
<i>9600</i> = 9600 Baud	<i>19200</i> = 19,200 Baud	<i>38400</i> = 38,400 Baud
<i>57600</i> = 57,600 Baud	<i>115200</i> = 115,200 Baud	

DATA= (Data Bits)

Press the **F3/ ↵** key to show the current setting. If the setting displayed is acceptable, press the **F3/ ↵** key again to save it. Otherwise, use the **F2/▲** key to toggle to a new setting and then press the **F3/ ↵** key to save it. Allowable settings are:

7 = 7 data bits

8 = 8 data bits

PARITY (Parity Setting)

Press the **F3/ ↵** key to show the current setting. If the setting displayed is acceptable, press the **F3/ ↵** key again to save it. Otherwise, use the **F2/ ▲** key to toggle to a new setting and then press the **F3/ ↵** key to save it. Allowable settings are:

none	None = No Parity
odd	odd = Odd Parity
even	Even = Even Parity

STOP (Stop Bits)

Press the **F3/ ↵** key to show the current setting. If the setting displayed is acceptable, press the **F3/ ↵** key again to save it. Otherwise, use the **F2/ ▲** key to toggle to a new setting and then press the **F3/ ↵** key to save it. Allowable settings are:

1	1 = One Stop Bit
1.5	1.5 = One and one half Stop Bits
2	2 = Two Stop Bits

WEIGHT (Weight Mode)

Press the **F3/ ↵** key to show the current setting. If the setting displayed is acceptable, press the **F3/ ↵** key again to save it. Otherwise, use the **F2/ ▲** key to toggle to a new setting and then press the **F3/ ↵** key to save it. Allowable settings are:

weight	Weight-On-Demand
SMA	SMA Output Format
COMP	Computer Output Format
COMP2	Computer Output Format 2
OFF	Off (Weight mode is disabled)

***d r n d* - Weight-On-Demand**

If Weight-On-Demand has been selected, the 201 will respond to a weight request (ENQ).

The host device (computer) sends:

ENQ - (hex 05)

The 201 will respond:

<s><xxxxxx><d><uu><m><cc><cr>

Where:

s =	Sign	"-" = negative " " (<i>blank</i>) = positive
xxxxxx.xxx =	Weight	Six digits
d =	Decimal point	Added to string if enabled in setup
uu =	Units	lb, kg, oz, g
m =	Mode	G = Gross, N = Net
cc =	Weight Status	OC = overcap CZ = center of zero MO = motion ee = weight not currently being displayed
cr =	Carriage Return	(hex 0D)

***d r n d* - Weight-On-Demand (SMA Format)**

If Weight-On-Demand has been selected, the 201 will respond to an SMA weight request.

The host device (computer) sends:

<LF>W<CR>

The 201 will respond:

<lf><s><r><n><m><f><xxxxxx.xxx><uuu><cr>

NOTE: The Weight-On-Demand (SMA Format) is the same as the SMA Continuous Output Format. Refer to the description of the data on the next page.

5.7.7.1 - SMA Continuous Output Format

If SMA is selected, the data will be transmitted in the following format:

<lf><s><r><n><m><f><xxxxxx.xxx><uuu><cr>

Where:

lf =	Line Feed	
s =	Flags	Z= center of Zero O = Overcap E = zero Error, e = weight not currently being displayed
r =	Range	1, 2, 3, ...
n =	Mode	G = Gross, T = Tare, N = Net
m =	Motion	M = Motion, " " (<i>blank</i>) = no motion
f =	Custom	Custom flag
xxxxxx.xxx =	Weight	Six digits with decimal point
uuu =	Units	lb, kg, oz, g
cr =	Carriage Return	(hex 0D)

5.7.7.2 - Computer Output Format

If ComP is selected, the data will be transmitted in the following format:

<s><xxxxxx><d><uu><m><cc><cr>

Where:

s =	Sign	"-" = negative " " (<i>blank</i>) = positive
xxxxxx.xxx =	Weight	Six digits
d =	Decimal point	Added to string if enabled in setup
uu =	Units	LB, KG, OZ, G
m =	Mode	G = Gross, N = Net
cc =	Weight Status	OC = overcap CZ = center of zero MO = motion ee = weight not currently being displayed
cr =	Carriage Return	(hex 0D)

ComP2 - Computer Output Format 2

If ComP is selected, the data will be transmitted in the following format:

<s><xxxxxx><d><uu><m><cc><cr>

Where:

s =	Sign	"-" = negative " " (<i>blank</i>) = positive
xxxxxx.xxx =	Weight	Six digits
d =	Decimal point	Added to string if enabled in setup
uu =	Units	lb, kg, oz, g (<i>note lower case units</i>)
m =	Mode	G = Gross, N = Net
cc =	Weight Status	OC = overcap CZ = center of zero MO = motion ee = weight not currently being displayed
cr =	Carriage Return	(hex 0D)

Print: (Print from Port)

Press the **F3/ ↵** key to show the current setting. If the setting displayed is acceptable, press the **F3/ ↵** key again to save it. Otherwise, use the **F2/▲** key to toggle to a new setting and then press the **F3/ ↵** key to save it. Allowable settings are:

oFF	Off (Print from Port is disabled)
tAbS	Print using Print Tab Settings
CsU	Print using Comma Separated Values

5.7 Ethernet Port

EthEr

With *EthEr* displayed, press the **F3/ ↵** key. The display will change to *EnAbL=*. Proceed to the *EnAbL=* (Enable Ethernet Port) parameter.

EnAbL= (Enable Ethernet Port)

Press the **F3/ ↵** key to show the current setting. If the setting displayed is acceptable, press the **F3/ ↵** key again to save it. Otherwise, use the **F2/▲** key to toggle to a new setting and then press the **F3/ ↵** key to save it. Allowable settings are:

<i>oFF</i>	Off (Ethernet port is Disabled)
<i>oN</i>	ON (Ethernet port is Enabled)

dHCP= (Enable DHCP)

Press the **F3/ ↵** key to show the current setting. If the setting displayed is acceptable, press the **F3/ ↵** key again to save it. Otherwise, use the **F2/▲** key to toggle to a new setting and then press the **F3/ ↵** key to save it. Allowable settings are:

<i>oFF</i>	Off (DHCP is Disabled)
<i>oN</i>	ON (DHCP is Enabled)



NOTE: If *dHCP=* (Enable DHCP) is disable (*oFF*), the following prompts, IP address, Netmask, Gateway and DNS will be active.

IP 1= (IP Address, First Part)

The format for an IP address is: ## . # . # . ## (e.g., 90.1.2.68). This parameter is the first part of the address.

Press the **F3/ ↵** key to view the current setting for the first part of the IP address. If the displayed setting is acceptable, press the **F3/ ↵** key to save it. Otherwise, use the **F2/▲** and **F1/◀** keys to enter a new setting and press the **F3/ ↵** key to save the new setting. Allowable values are: 000 through 255.

***IP2* (IP Address, Second Part)**

The format for an IP address is: ## . # . # . ## (e.g., 90.1.2.68). This parameter is the second part of the address.

Press the **F3/ ↵** key to view the current setting for the second part of the IP address. If the displayed setting is acceptable, press the **F3/ ↵** key to save it. Otherwise, use the **F2/▲** and **F1/◀** keys to enter a new setting and press the **F3/ ↵** key to save the new setting. Allowable values are: 000 through 255.

***IP3* (IP Address, Third Part)**

The format for an IP address is: ## . # . # . ## (e.g., 90.1.2.68). This parameter is the third part of the address.

Press the **F3/ ↵** key to view the current setting for the third part of the IP address. If the displayed setting is acceptable, press the **F3/ ↵** key to save it. Otherwise, use the **F2/▲** and **F1/◀** keys to enter a new setting and press the **F3/ ↵** key to save the new setting. Allowable values are: 000 through 255.

***IP4* (IP Address, Fourth Part)**

The format for an IP address is: ## . # . # . ## (e.g., 90.1.2.68). This parameter is the fourth part of the address.

Press the **F3/ ↵** key to view the current setting for the fourth part of the IP address. If the displayed setting is acceptable, press the **F3/ ↵** key to save it. Otherwise, use the **F2/▲** and **F1/◀** keys to enter a new setting and press the **F3/ ↵** key to save the new setting. Allowable values are: 000 through 255.

***net 1* (Netmask, First Part)**

The format for the Netmask is: ### . ### . ### . # (e.g., 255.255.252.0). This parameter is the first part of the Netmask.

Press the **F3/ ↵** key to view the current setting for the first part of the Netmask. If the displayed setting is acceptable, press the **F3/ ↵** key to save it. Otherwise, use the **F2/▲** and **F1/◀** keys to enter a new setting and press the **F3/ ↵** key to save the new setting. Allowable values are: 000 through 255.

nEt2 (Netmask, Second Part)

The format for the Netmask is: ### . ### . ### . # (e.g., 255.255.252.0). This parameter is the second part of the Netmask.

Press the **F3/ ↵** key to view the current setting for the second part of the Netmask. If the displayed setting is acceptable, press the **F3/ ↵** key to save it. Otherwise, use the **F2/▲** and **F1/◀** keys to enter a new setting and press the **F3/ ↵** key to save the new setting. Allowable values are: 000 through 255.

nEt3 (Netmask, Third Part)

The format for the Netmask is: ### . ### . ### . # (e.g., 255.255.252.0). This parameter is the third part of the Netmask.

Press the **F3/ ↵** key to view the current setting for the third part of the Netmask. If the displayed setting is acceptable, press the **F3/ ↵** key to save it. Otherwise, use the **F2/▲** and **F1/◀** keys to enter a new setting and press the **F3/ ↵** key to save the new setting. Allowable values are: 000 through 255.

nEt4 (Netmask, Fourth Part)

The format for the Netmask is: ### . ### . ### . # (e.g., 255.255.252.0). This parameter is the fourth part of the Netmask.

Press the **F3/ ↵** key to view the current setting for the fourth part of the Netmask. If the displayed setting is acceptable, press the **F3/ ↵** key to save it. Otherwise, use the **F2/▲** and **F1/◀** keys to enter a new setting and press the **F3/ ↵** key to save the new setting. Allowable values are: 000 through 255.

gAtE 1: (Gateway Address, First Part)

The format for the gateway address is: # . # . # . # (e.g., 0.0.0.0). This parameter is the first part of the address.

Press the **F3/ ↵** key to view the current setting for the first part of the IP address. If the displayed setting is acceptable, press the **F3/ ↵** key to save it. Otherwise, use the **F2/▲** and **F1/◀** keys to enter a new setting and press the **F3/ ↵** key to save the new setting. Allowable values are: 000 through 255.

gAtE2: (Gateway Address, Second Part)

The format for the gateway address is: # . # . # . # (e.g., 0.0.0.0). This parameter is the second part of the address.

Press the **F3/ ↵** key to view the current setting for the second part of the IP address. If the displayed setting is acceptable, press the **F3/ ↵** key to save it. Otherwise, use the **F2/▲** and **F1/◀** keys to enter a new setting and press the **F3/ ↵** key to save the new setting. Allowable values are: 000 through 255.

gAtE3: (Gateway Address, Third Part)

The format for the gateway address is: # . # . # . # (e.g., 0.0.0.0). This parameter is the third part of the address.

Press the **F3/ ↵** key to view the current setting for the third part of the IP address. If the displayed setting is acceptable, press the **F3/ ↵** key to save it. Otherwise, use the **F2/▲** and **F1/◀** keys to enter a new setting and press the **F3/ ↵** key to save the new setting. Allowable values are: 000 through 255.

gAtE4: (Gateway Address, Fourth Part)

The format for the gateway address is: # . # . # . # (e.g., 0.0.0.0). This parameter is the fourth part of the address.

Press the **F3/ ↵** key to view the current setting for the fourth part of the IP address. If the displayed setting is acceptable, press the **F3/ ↵** key to save it. Otherwise, use the **F2/▲** and **F1/◀** keys to enter a new setting and press the **F3/ ↵** key to save the new setting. Allowable values are: 000 through 255.

dnS1 (Domain Name Server, First Part)

The format for the Domain Name Server is: ## . # . # . # (e.g., 90.1.2.8). This parameter is the first part of the Domain Name Server.

Press the **F3/ ↵** key to view the current setting for the first part of the Netmask. If the displayed setting is acceptable, press the **F3/ ↵** key to save it. Otherwise, use the **F2/▲** and **F1/◀** keys to enter a new setting and press the **F3/ ↵** key to save the new setting. Allowable values are: 000 through 255.

dn52 (Domain Name Server, Second Part)

The format for the Domain Name Server is: ## . # . # . # (e.g., 90.1.2.8). This parameter is the second part of the Domain Name Server.

Press the **F3/ ↵** key to view the current setting for the second part of the Netmask. If the displayed setting is acceptable, press the **F3/ ↵** key to save it. Otherwise, use the **F2/▲** and **F1/◀** keys to enter a new setting and press the **F3/ ↵** key to save the new setting. Allowable values are: 000 through 255.

dn53 (Domain Name Server, Third Part)

The format for the Domain Name Server is: ## . # . # . # (e.g., 90.1.2.8). This parameter is the third part of the Domain Name Server.

Press the **F3/ ↵** key to view the current setting for the third part of the Netmask. If the displayed setting is acceptable, press the **F3/ ↵** key to save it. Otherwise, use the **F2/▲** and **F1/◀** keys to enter a new setting and press the **F3/ ↵** key to save the new setting. Allowable values are: 000 through 255.

dn54 (Domain Name Server, Fourth Part)

The format for the Domain Name Server is: ## . # . # . # (e.g., 90.1.2.8). This parameter is the fourth part of the Domain Name Server.

Press the **F3/ ↵** key to view the current setting for the fourth part of the Netmask. If the displayed setting is acceptable, press the **F3/ ↵** key to save it. Otherwise, use the **F2/▲** and **F1/◀** keys to enter a new setting and press the **F3/ ↵** key to save the new setting. Allowable values are: 000 through 255.

HTTP: (Enable Web Server)

Press the **F3/ ↵** key to show the current setting. If the setting displayed is acceptable, press the **F3/ ↵** key again to save it. Otherwise, use the **F2/▲** key to toggle to a new setting and then press the **F3/ ↵** key to save it. Allowable settings are:

- off* Off (Web Server is Disabled)
- on* ON (Web Server is Enabled)



NOTE: If *HTTP* (Web Server) is Enabled (*on*), the following prompts, Port and Limit Access will be active.

Port: (Web Server Port)

Press the **F3/ ↵** key to show the current setting. To accept the setting displayed, press the **F3/ ↵** key again to save it. Otherwise, use the **F2/▲** and **F1/◀** keys to enter a new setting and then press the **F3/ ↵** key to save it. Allowable values for the web server port are: 0 through 65000.

Limit: (Limit Access by Client IP Range)

Press the **F3/ ↵** key to show the current setting. If the setting displayed is acceptable, press the **F3/ ↵** key again to save it. Otherwise, use the **F2/▲** key to toggle to a new setting and then press the **F3/ ↵** key to save it. Allowable settings are:

- no* No limit
- CFG* Limit Configuration
- ALL* Limit ALL access

Soc: (Enable Raw Socket Server)

Press the **F3/ ↵** key to show the current setting. If the setting displayed is acceptable, press the **F3/ ↵** key again to save it. Otherwise, use the **F2/▲** key to toggle to a new setting and then press the **F3/ ↵** key to save it. Allowable settings are:

- oFF Off (Raw Socket Server is Disabled)
- oN ON (Raw Socket Server is Enabled)



IMPORTANT! If EIP (Ethernet/IP) or Modbus/TCP is enabled, the Raw Socket Server (Soc) should be disabled (set to oFF).

NOTE: If Soc (Raw Socket Server) is Enabled (oN), the following prompts, Port: (Raw Socket Server Port), modE: (Weight Mode) and Print: (Print from Port) will be displayed.

Port: (Raw Socket Server Port)

Press the **F3/ ↵** key to show the current setting. To accept the setting displayed, press the **F3/ ↵** key again to save it. Otherwise, use the **F2/▲** and **F1/◀** keys to enter a new setting and then press the **F3/ ↵** key to save it. Allowable values for the raw socket server port are: 0 through 65000.

modE: (Weight Mode)

Press the **F3/ ↵** key to show the current setting. If the setting displayed is acceptable, press the **F3/ ↵** key again to save it. Otherwise, use the **F2/▲** key to toggle to a new setting and then press the **F3/ ↵** key to save it. Allowable settings are:

- oOnD Weight-On-Demand
- SMA SMA Output Format
- [Comp Computer Output Format
- [Comp2 Computer Output Format 2
- oFF Off (Weight mode is disabled)

***drnd* - Weight-On-Demand**

If Weight-On-Demand has been selected, the 201 will respond to a weight request (ENQ).

The host device (computer) sends:

ENQ - (hex 05)

The 201 will respond:

<s><xxxxxx><d><uu><m><cc><cr>

Where:

s =	Sign	"-" = negative " " (<i>blank</i>) = positive
xxxxxx.xxx =	Weight	Six digits
d =	Decimal point	Added to string if enabled in setup
uu =	Units	lb, kg, oz, g
m =	Mode	G = Gross, N = Net
cc =	Weight Status	OC = overcap CZ = center of zero MO = motion ee = weight not currently being displayed
cr =	Carriage Return	(hex 0D)

***drnd* - Weight-On-Demand (SMA Format)**

If Weight-On-Demand has been selected, the 201 will respond to an SMA weight request.

The host device (computer) sends:

<LF>W<CR>

The 201 will respond:

<lf><s><r><n><m><f><xxxxxx.xxx><uuu><cr>

NOTE: The Weight-On-Demand (SMA Format) is the same as the SMA Continuous Output Format. Refer to the description of the data on the next page.

577P - SMA Continuous Output Format

If SMA is selected, the data will be transmitted in the following format:

<lf><s><r><n><m><f><xxxxxx.xxx><uuu><cr>

Where:

lf =	Line Feed	
s =	Flags	Z= center of Zero O = Overcap E = zero Error, e = weight not currently being displayed
r =	Range	1, 2, 3, ...
n =	Mode	G = Gross, T = Tare, N = Net
m =	Motion	M = Motion, " "(blank) = no motion
f =	Custom	Custom flag
xxxxxx.xxx =	Weight	Six digits with decimal point
uuu =	Units	lb, kg, oz, g
cr =	Carriage Return	(hex 0D)

677P - Computer Output Format

If ComP is selected, the data will be transmitted in the following format:

<s><xxxxxx><d><uu><m><cc><cr>

Where:

s =	Sign	"-" = negative " " (blank) = positive
xxxxxx.xxx =	Weight	Six digits
d =	Decimal point	Added to string if enabled in setup
uu =	Units	LB, KG, OZ, G
m =	Mode	G = Gross, N = Net
cc =	Weight Status	OC = overcap CZ = center of zero MO = motion ee = weight not currently being displayed
cr =	Carriage Return	(hex 0D)

ComP2 - Computer Output Format 2

If ComP is selected, the data will be transmitted in the following format:

<s><xxxxxx><d><uu><m><cc><cr>

Where:

s =	Sign	"-" = negative " " (<i>blank</i>) = positive
xxxxxx.xxx =	Weight	Six digits
d =	Decimal point	Added to string if enabled in setup
uu =	Units	lb, kg, oz, g (note lower case units)
m =	Mode	G = Gross, N = Net
cc =	Weight Status	OC = overcap CZ = center of zero MO = motion ee = weight not currently being displayed
cr =	Carriage Return	(hex 0D)

Print: (Print from Port)

Press the **F3/ ↵** key to show the current setting. If the setting displayed is acceptable, press the **F3/ ↵** key again to save it. Otherwise, use the **F2/ ▲** key to toggle to a new setting and then press the **F3/ ↵** key to save it. Allowable settings are:

oFF	Off (Print from Port is disabled)
tAbS	Print using Print Tab Settings
[Sv	Print using Comma Separated Values

***E IP* = (Enable Ethernet/IP)**

Press the **F3/ ←** key to show the current setting. If the setting displayed is acceptable, press the **F3/ ←** key again to save it. Otherwise, use the **F2/▲** key to toggle to a new setting and then press the **F3/ ←** key to save it. Allowable settings are:

- off* Off (Ethernet/IP is Disabled)
- on* ON (Ethernet/IP is Enabled)



NOTE: If *E IP* = (Enable Ethernet/IP) is Enabled (*on*), the following prompts, Output Weight as... and Output weight byte order will be active.

***For* = (Output Weight as...)**

Press the **F3/ ←** key to show the current setting. If the setting displayed is acceptable, press the **F3/ ←** key again to save it. Otherwise, use the **F2/▲** key to toggle to a new setting and then press the **F3/ ←** key to save it. Allowable settings are:

- FLoAt* Output Weight as Float
- int* Output Weight as Integer

***ord* = (Output Weight Byte Order)**

Press the **F3/ ←** key to show the current setting. If the setting displayed is acceptable, press the **F3/ ←** key again to save it. Otherwise, use the **F2/▲** key to toggle to a new setting and then press the **F3/ ←** key to save it. Allowable settings are:

- 1234* *4321* *3412* *2143*

modbus (Enable Modbus/TCP)

Press the **F3/ ↵** key to show the current setting. If the setting displayed is acceptable, press the **F3/ ↵** key again to save it. Otherwise, use the **F2/ ▲** key to toggle to a new setting and then press the **F3/ ↵** key to save it. Allowable settings are:

- off* Off (Modbus/TCP is Disabled)
- on* ON (Modbus/TCP is Enabled)



NOTE: If *modbus* (Enable Modbus/TCP) is Enabled (*on*), the following prompts, Output Weight as... and Output weight byte order will be active.

For: (Output Weight as...)

Press the **F3/ ↵** key to show the current setting. If the setting displayed is acceptable, press the **F3/ ↵** key again to save it. Otherwise, use the **F2/ ▲** key to toggle to a new setting and then press the **F3/ ↵** key to save it. Allowable settings are:

- float* Output Weight as Float
- int* Output Weight as Integer

ord: (Output Weight Byte Order)

Press the **F3/ ↵** key to show the current setting. If the setting displayed is acceptable, press the **F3/ ↵** key again to save it. Otherwise, use the **F2/ ▲** key to toggle to a new setting and then press the **F3/ ↵** key to save it. Allowable settings are:

- 1234*
- 4321*
- 3412*
- 2143*

5.8 USB Port

USB

With *USB* displayed, press the **F3/ ↵** key. The display will change to *EnABL=*. Proceed to the *EnABL=* (Enable USB Port) parameter.

EnABL= (Enable USB Port)

Press the **F3/ ↵** key to show the current setting. If the setting displayed is acceptable, press the **F3/ ↵** key again to save it. Otherwise, use the **F2/ ▲** key to toggle to a new setting and then press the **F3/ ↵** key to save it. Allowable settings are:

<i>oFF</i>	Off (USB port is Disabled)
<i>oN</i>	ON (USB port is Enabled)



NOTE: If *USB* (USB Port) is Enabled (*oN*), the following prompts, Weight Mode and Print from Port will be active.

oNsErE= (Weight Mode)

Press the **F3/ ↵** key to show the current setting. If the setting displayed is acceptable, press the **F3/ ↵** key again to save it. Otherwise, use the **F2/ ▲** key to toggle to a new setting and then press the **F3/ ↵** key to save it. Allowable settings are:

<i>oNsErE</i>	Weight-On-Demand
<i>SrRrA</i>	SMA Output Format
<i>[oNsErE]P</i>	Computer Output Format
<i>[oNsErE]P2</i>	Computer Output Format 2
<i>oFF</i>	Off (Weight mode is disabled)

***drnd* - Weight-On-Demand**

If Weight-On-Demand has been selected, the 201 will respond to a weight request (ENQ).

The host device (computer) sends:

ENQ - (hex 05)

The 201 will respond:

<s><xxxxxx><d><uu><m><cc><cr>

Where:

s =	Sign	"-" = negative " " (<i>blank</i>) = positive
xxxxxx.xxx =	Weight	Six digits
d =	Decimal point	Added to string if enabled in setup
uu =	Units	lb, kg, oz, g
m =	Mode	G = Gross, N = Net
cc =	Weight Status	OC = overcap CZ = center of zero MO = motion ee = weight not currently being displayed
cr =	Carriage Return	(hex 0D)

***drnd* - Weight-On-Demand (SMA Format)**

If Weight-On-Demand has been selected, the 201 will respond to an SMA weight request.

The host device (computer) sends:

<LF>W<CR>

The 201 will respond:

<lf><s><r><n><m><f><xxxxxx.xxx><uuu><cr>

NOTE: The Weight-On-Demand (SMA Format) is the same as the SMA Continuous Output Format. Refer to the description of the data on the next page.

577P - SMA Continuous Output Format

If SMA is selected, the data will be transmitted in the following format:

<lf><s><r><n><m><f><xxxxxx.xxx><uuu><cr>

Where:

lf =	Line Feed	
s =	Flags	Z= center of Zero O = Overcap E = zero Error, e = weight not currently being displayed
r =	Range	1, 2, 3, ...
n =	Mode	G = Gross, T = Tare, N = Net
m =	Motion	M = Motion, " "(blank) = no motion
f =	Custom	Custom flag
xxxxxx.xxx =	Weight	Six digits with decimal point
uuu =	Units	lb, kg, oz, g
cr =	Carriage Return	(hex 0D)

677P - Computer Output Format

If ComP is selected, the data will be transmitted in the following format:

<s><xxxxxx><d><uu><m><cc><cr>

Where:

s =	Sign	"-" = negative " " (blank) = positive
xxxxxx.xxx =	Weight	Six digits
d =	Decimal point	Added to string if enabled in setup
uu =	Units	LB, KG, OZ, G
m =	Mode	G = Gross, N = Net
cc =	Weight Status	OC = overcap CZ = center of zero MO = motion ee = weight not currently being displayed
cr =	Carriage Return	(hex 0D)

ComP2 - Computer Output Format 2

If ComP is selected, the data will be transmitted in the following format:

<s><xxxxxx><d><uu><m><cc><cr>

Where:

s =	Sign	"-" = negative " " (<i>blank</i>) = positive
xxxxxx.xxx =	Weight	Six digits
d =	Decimal point	Added to string if enabled in setup
uu =	Units	lb, kg, oz, g (note lower case units)
m =	Mode	G = Gross, N = Net
cc =	Weight Status	OC = overcap CZ = center of zero MO = motion ee = weight not currently being displayed
cr =	Carriage Return	(hex 0D)

Print: (Print from Port)

Press the **F3/ ↵** key to show the current setting. If the setting displayed is acceptable, press the **F3/ ↵** key again to save it. Otherwise, use the **F2/ ▲** key to toggle to a new setting and then press the **F3/ ↵** key to save it. Allowable settings are:

oFF	Off (Print from Port is disabled)
tAbS	Print using Print Tab Settings
[Sv	Print using Comma Separated Values

5.9 Analog Input/Output

ANAO

With *ANAO* displayed, press the **F3/ ↵** key. The display will change to *DAO 1*. Proceed to the *DAO 1* (Analog Output 1, Current) parameter.

DAO 1 (Analog Output 1, Current)

Press the **F3/ ↵** key to show the current setting. If the setting displayed is acceptable, press the **F3/ ↵** key again to save it. Otherwise, use the **F2/▲** key to toggle to a new setting and then press the **F3/ ↵** key to save it. Allowable settings are:

<i>OFF</i>	Off (Analog Output 1 is disabled)
<i>GRSS</i>	Track Gross Weight
<i>NET</i>	Track Net Weight
<i>4 mA</i>	4 mA output
<i>6 mA</i>	6 mA output
<i>8 mA</i>	8 mA output
<i>10 mA</i>	10 mA output
<i>12 mA</i>	12 mA output
<i>14 mA</i>	14 mA output
<i>16 mA</i>	16 mA output
<i>18 mA</i>	18 mA output
<i>20 mA</i>	20 mA output

DAO (Minimum Weight – 4 mA)

This is the value, in weight, which outputs 4 mA from the DAC. All weight below this target will output 4 mA.

Press the **F3/ ↵** key to show the current setting. To accept the setting displayed, press the **F3/ ↵** key again to save it. Otherwise, use the **F2/▲** and **F1/◀** keys to enter a new setting and then press the **F3/ ↵** key to save it. Allowable values are: 0 through 999999.

NOTE: If a negative weight is required for the minimum weight, you must use the Web Configuration Page.

***d1b* = (Maximum Weight – 20 mA)**

This is the value, in weight, which outputs the maximum current 20 mA. All weights above this value will output maximum current from the DAC.

Press the **F3/ ←** key to show the current setting. To accept the setting displayed, press the **F3/ ←** key again to save it. Otherwise, use the **F2/▲** and **F1/◀** keys to enter a new setting and then press the **F3/ ←** key to save it.

This weight must be a positive value, up to capacity of scale, and above the *d1a* value. Allowable values: 0 through 999999.

***dAC2* = (Analog Output 2, Voltage)**

Press the **F3/ ←** key to show the current setting. If the setting displayed is acceptable, press the **F3/ ←** key again to save it. Otherwise, use the **F2/▲** key to toggle to a new setting and then press the **F3/ ←** key to save it. Allowable settings are:

<i>off</i>	Off (Analog Output 2 is disabled)
<i>gross</i>	Track Gross Weight
<i>net</i>	Track Net Weight
<i>0 v</i>	0 volt output
<i>1 v</i>	1 volt output
<i>2 v</i>	2 volt output
<i>3 v</i>	3 volt output
<i>4 v</i>	4 volt output
<i>5 v</i>	5 volt output
<i>6 v</i>	6 volt output
<i>7 v</i>	7 volt output
<i>8 v</i>	8 volt output
<i>9 v</i>	9 volt output
<i>10 v</i>	10 volt output

d2A: **(Minimum Weight – 0 volts)**

This is the value, in weight, which outputs 0 volts from the DAC. All weight below this target will output 0 volts.

Press the **F3/ ↵** key to show the current setting. To accept the setting displayed, press the **F3/ ↵** key again to save it. Otherwise, use the **F2/ ▲** and **F1/ ◀** keys to enter a new setting and then press the **F3/ ↵** key to save it. Allowable values are: 0 through 999999.

NOTE: If a negative weight is required for the minimum weight, you must use the Web Configuration Page.

d2b: **(Maximum Weight – 10 volts)**

This is the value, in weight, which outputs the maximum output 10 volts. All weights above this value will output maximum volts from the DAC.

Press the **F3/ ↵** key to show the current setting. To accept the setting displayed, press the **F3/ ↵** key again to save it. Otherwise, use the **F2/ ▲** and **F1/ ◀** keys to enter a new setting and then press the **F3/ ↵** key to save it.

This weight must be a positive value, up to capacity of scale, and above the *d2A:* value. Allowable values: 0 through 999999.

RdE: **(Analog Input)**

Press the **F3/ ↵** key to show the current setting. If the setting displayed is acceptable, press the **F3/ ↵** key again to save it. Otherwise, use the **F2/ ▲** key to toggle to a new setting and then press the **F3/ ↵** key to save it. Allowable settings are:

- off* Off (Analog Input is disabled)
- volt* Read Voltage
- current* Read Current

5.10 Digital Input/Output

d i g i o

With *d i g i o* displayed, press the **F3/ ←** key. The display will change to *inP 1=*. Proceed to the *inP 1=* (Digital Input 1) parameter.

inP 1= (Digital Input 1)

Press the **F3/ ←** key to show the current setting. If the setting displayed is acceptable, press the **F3/ ←** key again to save it. Otherwise, use the **F2/▲** key to toggle to a new setting and then press the **F3/ ←** key to save it. Allowable settings are:

<u>Selection</u>	<u>Function</u>
<i>oFF</i>	Off (Digital Input 1 is disabled)
<i>ZEro</i>	Zero Scale
<i>tArE</i>	Tare
<i>Gr-net</i>	Gross/Net
<i>Un itS</i>	Units
<i>Pr int</i>	Print
<i>dFCS t</i>	Digital Fill Control Start/Pause
<i>dFCD C</i>	Digital Fill Control Discharge

INP 2: (Digital Input 2)

Press the **F3/ ↵** key to show the current setting. If the setting displayed is acceptable, press the **F3/ ↵** key again to save it. Otherwise, use the **F2/▲** key to toggle to a new setting and then press the **F3/ ↵** key to save it. Allowable settings are:

<u>Selection</u>	<u>Function</u>
<i>oFF</i>	Off (Digital Input 2 is disabled)
<i>ZEro</i>	Zero Scale
<i>tArE</i>	Tare
<i>Gr-net</i>	Gross/Net
<i>Units</i>	Units
<i>Print</i>	Print
<i>dFCS</i>	Digital Fill Control Start/Pause
<i>dFCD</i>	Digital Fill Control Discharge

INP 3: (Digital Input 3)

Press the **F3/ ↵** key to show the current setting. If the setting displayed is acceptable, press the **F3/ ↵** key again to save it. Otherwise, use the **F2/▲** key to toggle to a new setting and then press the **F3/ ↵** key to save it. Allowable settings are:

<u>Selection</u>	<u>Function</u>
<i>oFF</i>	Off (Digital Input 3 is disabled)
<i>ZEro</i>	Zero Scale
<i>tArE</i>	Tare
<i>Gr-net</i>	Gross/Net
<i>Units</i>	Units
<i>Print</i>	Print
<i>dFCS</i>	Digital Fill Control Start/Pause
<i>dFCD</i>	Digital Fill Control Discharge

inp 4: (Digital Input 4)

Press the **F3/ ↵** key to show the current setting. If the setting displayed is acceptable, press the **F3/ ↵** key again to save it. Otherwise, use the **F2/▲** key to toggle to a new setting and then press the **F3/ ↵** key to save it. Allowable settings are:

<u>Selection</u>	<u>Function</u>
<i>oFF</i>	Off (Digital Input 4 is disabled)
<i>zErO</i>	Zero Scale
<i>tArE</i>	Tare
<i>Gr-nEt</i>	Gross/Net
<i>Un itS</i>	Units
<i>Pr int</i>	Print
<i>dFCS t</i>	Digital Fill Control Start/Pause
<i>dFCD C</i>	Digital Fill Control Discharge

out 1: (Digital Output 1)

Press the **F3/ ↵** key to show the current setting. If the setting displayed is acceptable, press the **F3/ ↵** key again to save it. Otherwise, use the **F2/▲** key to toggle to a new setting and then press the **F3/ ↵** key to save it. Allowable settings are:

<u>Selection</u>	<u>Function</u>
<i>oFF</i>	Off (Digital Output 1 is disabled)
<i>UndEr</i>	Check weigh Under
<i>ACC EPt</i>	Check weigh Accept
<i>oEr</i>	Check weigh Over

out 2: **(Digital Output 2)**

Press the **F3/ ↵** key to show the current setting. If the setting displayed is acceptable, press the **F3/ ↵** key again to save it. Otherwise, use the **F2/▲** key to toggle to a new setting and then press the **F3/ ↵** key to save it. Allowable settings are:

<u>Selection</u>	<u>Function</u>
<i>oFF</i>	Off (Digital Output 2 is disabled)
<i>UndEr</i>	Check weigh Under
<i>ACCEPt</i>	Check weigh Accept
<i>oEr</i>	Check weigh Over

out 3: **(Digital Output 3)**

Press the **F3/ ↵** key to show the current setting. If the setting displayed is acceptable, press the **F3/ ↵** key again to save it. Otherwise, use the **F2/▲** key to toggle to a new setting and then press the **F3/ ↵** key to save it. Allowable settings are:

<u>Selection</u>	<u>Function</u>
<i>oFF</i>	Off (Digital Output 3 is disabled)
<i>UndEr</i>	Check weigh Under
<i>ACCEPt</i>	Check weigh Accept
<i>oEr</i>	Check weigh Over

out 4: **(Digital Output 4)**

Press the **F3/ ↵** key to show the current setting. If the setting displayed is acceptable, press the **F3/ ↵** key again to save it. Otherwise, use the **F2/▲** key to toggle to a new setting and then press the **F3/ ↵** key to save it. Allowable settings are:

<u>Selection</u>	<u>Function</u>
<i>oFF</i>	Off (Digital Output 4 is disabled)
<i>UndEr</i>	Check weigh Under
<i>ACCEPt</i>	Check weigh Accept
<i>oEr</i>	Check weigh Over

5.11 Optional Memory Card

StorE

With *StorE* displayed, press the **F3/ ↵** key. The display will change to *EnAbL=*. Proceed to the *EnAbL=* (Enable Storage Card) parameter.

EnAbL= (Enable Storage Card)

Press the **F3/ ↵** key to show the current setting. If the setting displayed is acceptable, press the **F3/ ↵** key again to save it. Otherwise, use the **F2/ ▲** key to toggle to a new setting and then press the **F3/ ↵** key to save it. Allowable settings are:

<i>oFF</i>	Off (Storage Card is Disabled)
<i>oN</i>	ON (Storage Card is Enabled)



NOTE: If *StorE* (Storage Card) is Enabled (*oN*), the following prompts, Log Messages to Storage, Days to Keep Log Messages and Printer Output to Storage Card will be active.

LoG= (Log Messages to Storage)

Press the **F3/ ↵** key to show the current setting. If the setting displayed is acceptable, press the **F3/ ↵** key again to save it. Otherwise, use the **F2/ ▲** key to toggle to a new setting and then press the **F3/ ↵** key to save it. Allowable settings are:

<i>oFF</i>	Off (Log Messages to Storage is disabled)
<i>Err</i>	Errors Only
<i>ALL</i>	Everything

dAYS= (Days to Keep Log Messages)

Press the **F3/ ↵** key to show the current setting. To accept the setting displayed, press the **F3/ ↵** key again to save it. Otherwise, use the **F2/ ▲** and **F1/ ◀** keys to enter a new setting and then press the **F3/ ↵** key to save it. Allowable values for the number of days to keep log messages are: 0 through 255.

Print = **(Printer Output to Storage Card)**

Press the **F3/ ↵** key to show the current setting. If the setting displayed is acceptable, press the **F3/ ↵** key again to save it. Otherwise, use the **F2/ ▲** key to toggle to a new setting and then press the **F3/ ↵** key to save it. Allowable settings are:

- | | |
|-------------|------------------------------------|
| <i>off</i> | Off (Print from Port is disabled) |
| <i>tabs</i> | Print using Print Tab Settings |
| <i>csv</i> | Print using Comma Separated Values |

5.12 Enable Check Weighing

oErUnd

With *oErUnd* displayed, press the **F3/ ↵** key. The display will change to *EnAbL:*. Proceed to the *EnAbL:* (Enable Check Weighing) parameter.

EnAbL: **(Enable Check Weighing)**

Press the **F3/ ↵** key to show the current setting. If the setting displayed is acceptable, press the **F3/ ↵** key again to save it. Otherwise, use the **F2/▲** key to toggle to a new setting and then press the **F3/ ↵** key to save it. Allowable settings are:

<i>no</i>	no (Check Weighing is Disabled)
<i>YES</i>	YES (Check Weighing is Enabled)



NOTE: If *oErUnd* (Check weighing) is Enabled (*YES*), the following prompts, Accept Weight and Over Weight will be active.

ACCPt: **(Accept Weight)**

Press the **F3/ ↵** key to show the current setting. If the setting displayed is acceptable, press the **F3/ ↵** key again to save it. Otherwise, use the **F2/▲** and **F1/◀** keys to enter a new setting and then press the **F3/ ↵** key to save it. Allowable values for Accept Weight are: 0 through 999,999.

ouEr: **(Over Weight)**

Press the **F3/ ↵** key to show the current setting. If the setting displayed is acceptable, press the **F3/ ↵** key again to save it. Otherwise, use the **F2/▲** and **F1/◀** keys to enter a new setting and then press the **F3/ ↵** key to save it. Allowable values for Over Weight are: 0 through 999,999.

U CoL = (Checkweigher “Under” Backlight Color)

Press the **F3/ ←** key to show the current setting. If the setting displayed is acceptable, press the **F3/ ←** key again to save it. Otherwise, use the **F2/▲** key to toggle to a new setting and then press the **F3/ ←** key to save it. Allowable settings are:

<i>oFF</i>	oFF (Underweight backlight is disabled)
<i>rEd</i>	Red Underweight backlight color
<i>GrEEn</i>	Green Underweight backlight color
<i>YELLo</i>	Yellow Underweight backlight color
<i>BLuE</i>	Blue Underweight backlight color
<i>PurPLE</i>	Purple Underweight backlight color
<i>uWhItE</i>	White display backlight color
<i>PInC</i>	Pink display backlight color

A CoL = (Checkweigher “Accept” Backlight Color)

Press the **F3/ ←** key to show the current setting. If the setting displayed is acceptable, press the **F3/ ←** key again to save it. Otherwise, use the **F2/▲** key to toggle to a new setting and then press the **F3/ ←** key to save it. Allowable settings are:

<i>oFF</i>	oFF (Accept weight backlight is disabled)
<i>rEd</i>	Red Accept weight backlight color
<i>GrEEn</i>	Green Accept weight backlight color
<i>YELLo</i>	Yellow Accept weight backlight color
<i>BLuE</i>	Blue Accept weight backlight color
<i>PurPLE</i>	Purple Accept weight backlight color
<i>uWhItE</i>	White display backlight color
<i>PInC</i>	Pink display backlight color

o **COL = (Checkweigher “Over” Backlight Color)**

Press the **F3/ ↵** key to show the current setting. If the setting displayed is acceptable, press the **F3/ ↵** key again to save it. Otherwise, use the **F2/▲** key to toggle to a new setting and then press the **F3/ ↵** key to save it. Allowable settings are:

<i>oFF</i>	oFF (Over weight backlight is disabled)
<i>rEd</i>	Red Over weight backlight color
<i>GrEEn</i>	Green Over weight backlight color
<i>YELLo</i>	Yellow Over weight backlight color
<i>bluE</i>	Blue Over weight backlight color
<i>PurPLE</i>	Purple Over weight backlight color
<i>whitE</i>	White display backlight color
<i>Pinc</i>	Pink display backlight color

5.13 Enable Flow Rate

FLo

With *FLo* displayed, press the **F3/ ←** key. The display will change to *FLo=*. Proceed to the *FLo=* (Enable Flow Rate Measuring) parameter.

FLo= (Enable Flow Rate Measuring)

Press the **F3/ ←** key to show the current setting. If the setting displayed is acceptable, press the **F3/ ←** key again to save it. Otherwise, use the **F2/▲** key to toggle to a new setting and then press the **F3/ ←** key to save it. Allowable settings are:

<i>no</i>	no (Flow Rate Measuring is Disabled)
<i>YES</i>	YES (Flow Rate Measuring is Enabled)



NOTE: If *FLo=* (Flow Rate Measuring) is Enabled (*YES*), the following prompt, Unit will be active.

Unit= (Units for weight change)

Press the **F3/ ←** key to show the current setting. If the setting displayed is acceptable, press the **F3/ ←** key again to save it. Otherwise, use the **F2/▲** key to toggle to a new setting and then press the **F3/ ←** key to save it. Allowable settings are:

<i>10th S</i>	Weight Change per 1/10th Second
<i>SEC</i>	Weight Change per Second
<i>min</i>	Weight Change per Minute
<i>Hour</i>	Weight Change per Hour

5.14 Enable Digital Fill Control

dFC

With *dFC* displayed, press the **F3/ ↵** key. The display will change to *dFC =*. Proceed to the *dFC =* (Enable Digital Fill Control) parameter.

dFC = (Select Digital Fill Control Mode)

Press the **F3/ ↵** key to show the current setting. If the setting displayed is acceptable, press the **F3/ ↵** key again to save it. Otherwise, use the **F2/ ▲** key to toggle to a new setting and then press the **F3/ ↵** key to save it. Allowable settings are:

<i>oFF</i>	oFF (Digital Fill Control is off, Disabled)
<i>dI o</i>	DIO (Digital Fill Control is Enabled)

SPd = (Select Digital Fill Control Speed)

Press the **F3/ ↵** key to show the current setting. If the setting displayed is acceptable, press the **F3/ ↵** key again to save it. Otherwise, use the **F2/ ▲** key to toggle to a new setting and then press the **F3/ ↵** key to save it. Allowable settings are:

<i>1SP</i>	Single Speed
<i>2SP</i>	Dual Speed
<i>1SPt</i>	Single Speed Timed
<i>2SPC</i>	Dual Speed Chatter

tYP = (Digital Filling Type)

Press the **F3/ ↵** key to show the current setting. If the setting displayed is acceptable, press the **F3/ ↵** key again to save it. Otherwise, use the **F2/ ▲** key to toggle to a new setting and then press the **F3/ ↵** key to save it. Allowable settings are:

<i>AcG</i>	Accumulative Gross
<i>Acn</i>	Accumulative Net
<i>dEn</i>	Decumulative Net

FASt = **(Fast Target)**

This is the filling target that the 201 DFC is set to fill to in the fast part of the cycle.

Press the **F3/ ↵** key to show the current setting. If the setting displayed is acceptable, press the **F3/ ↵** key again to save it. Otherwise, use the **F2/ ▲** and **F1/ ◀** keys to enter a new setting and then press the **F3/ ↵** key to save it. Allowable values for Fast Target are: 0 through scale capacity.

FOUt = **(Fast Output)**

This is the output that is driven when fast filling is occurring. This is a binary field to allow for driving of more than one output during this stage of the filling cycle. For more information see the **11.2 Output Assigning** section.

SLo = **(Slow Target)**

This is the filling target that the 201 DFC is set to fill to in the slow part of the cycle.

Press the **F3/ ↵** key to show the current setting. If the setting displayed is acceptable, press the **F3/ ↵** key again to save it. Otherwise, use the **F2/ ▲** and **F1/ ◀** keys to enter a new setting and then press the **F3/ ↵** key to save it. Allowable values for Slow Target are: 0 through scale capacity.

SOUt = **(Slow Output)**

This is the output that is driven when slow filling is occurring. This is a binary field to allow for driving of more than one output during this stage of the filling cycle. For more information see the **11.2 Output Assigning** section.

זמנת יציאה (Output Timer)

This setting is used for the 1 speed timed mode of operation and controls how long the filling output is activated in milliseconds.

Press the **F3/ ↵** key to show the current setting. If the setting displayed is acceptable, press the **F3/ ↵** key again to save it. Otherwise, use the **F2/ ▲** and **F1/ ◀** keys to enter a new setting and then press the **F3/ ↵** key to save it.

יציאת שחרור (Discharge Output)

This is the output that is driven when discharging is occurring. This is a binary field to allow for driving of more than one output during this stage of the filling cycle. For more information see the **11.2 Output Assigning** section.

גודל תיקון (Trim)

This setting controls the trim value of the filling process. This is the amount of weight below the actual target value at which the output will be deactivated in order to accurately arrive at the target weight.

Press the **F3/ ↵** key to show the current setting. If the setting displayed is acceptable, press the **F3/ ↵** key again to save it. Otherwise, use the **F2/ ▲** and **F1/ ◀** keys to enter a new setting and then press the **F3/ ↵** key to save it.

ערשול אפס (Zero Tolerance)

If **AUTod=YES**, the completed fill operation will immediately discharge. The discharge will continue until the scale weight returns to zero within the **ערשול אפס (Zero Tolerance)** value.

Press the **F3/ ↵** key to show the current setting. If the setting displayed is acceptable, press the **F3/ ↵** key again to save it. Otherwise, use the **F2/ ▲** and **F1/ ◀** keys to enter a new setting and then press the **F3/ ↵** key to save it.

dyt r = **(Dynamic Trim)**

This setting controls whether the 201 DFC application will dynamically adjust the DFC Trim value based on overshoot/undershoot of each fill. This can be used to 'learn' the proper trim value. Once a trim value has been 'learned', which usually takes between 3 and 10 filling cycles, it is recommended to turn off dynamic trim.

Press the **F3/ ↵** key to show the current setting. If the setting displayed is acceptable, press the **F3/ ↵** key again to save it. Otherwise, use the **F2/ ▲** and **F1/ ◀** keys to enter a new setting and then press the **F3/ ↵** key to save it.

Autod = **(Auto Dump)**

This setting controls whether the 201 DFC will automatically discharge after filling or waits for input from the operator or other controlling system.

Press the **F3/ ↵** key to show the current setting. If the setting displayed is acceptable, press the **F3/ ↵** key again to save it. Otherwise, use the **F2/ ▲** key to toggle to a new setting and then press the **F3/ ↵** key to save it. Allowable settings are:

<i>no</i>	no (Manual Discharge)
<i>YES</i>	YES (Auto Discharge)

AutoP = **(Automatic Print)**

The automatic print feature will cause an optional printer to automatically record the total weight, time, and date of the fill at the conclusion of the fill.

Press the **F3/ ↵** key to show the current setting. If the setting displayed is acceptable, press the **F3/ ↵** key again to save it. Otherwise, use the **F2/ ▲** key to toggle to a new setting and then press the **F3/ ↵** key to save it. Allowable settings are:

<i>no</i>	no (No Automatic Print after fill operation)
<i>YES</i>	YES (Automatic Print after fill operation is Enabled)

5.14.1 Web Page Configuration

The other settings that have been added in order to facilitate the use of the 201 DFC application are to the Preferences and to the DIO setup. In order to facilitate use of the 201 DFC, F-Key button assignments for “Settings”, “Start/Pause”, and “Discharge” have been added.

Cardinal Scale Manufacturing Company

Home	<h3 style="margin: 0;">Preferences</h3> <hr/> <p>Language: <input type="text" value="English"/> ▼</p> <p>Date Order: <input type="text" value="Month/Day/Year"/> ▼</p> <p>Time 12 Hour: <input type="text" value="No"/> ▼</p> <p>F1 Key Assign: <input type="text" value="DFC presets"/> ▼</p> <p>F2 Key Assign: <input type="text" value="DFC Start/Pause"/> ▼</p> <p>F3 Key Assign: <input type="text" value="DFC Discharge"/> ▼</p> <p>Default Color: <input type="text" value="Blue"/> ▼</p> <p style="text-align: center;"><input type="button" value="Submit"/></p>
Event Counters	
Settings	
Date/Time	
Accumulators	
Setup	
Weighing Input	
Filter	
Ethernet	
USB	
Serial Port	
Print Codes	
Print Tabs	
Digital I/O	
Analog I/O	
Storage Memory	
Check Weigh	
Preferences	
Flow Rate	
Digital Fill Control	
Diagnostics	
Log file	

Also, to allow for remote push-button operation, similar settings have been added for the 201 input assignments.

Cardinal Scale Manufacturing Company

Home	Digital I/O
Event Counters	
Settings	
Date/Time	
Accumulators	
Setup	
Weighing Input	
Filter	
Ethernet	
USB	
Serial Port	
Print Codes	
Print Tabs	
Digital I/O	
Analog I/O	
Storage Memory	
Check Weigh	
Preferences	
Flow Rate	
Digital Fill Control	
Diagnostics	
Log file	

Input 1:	<input type="text" value="DFC Start"/>
Input 2:	<input type="text" value="DFC Discharge"/>
Input 3:	<input type="text" value="Off"/>
Input 4:	<input type="text" value="Off"/>
Output 1:	<input type="text" value="Off"/>
Output 2:	<input type="text" value="Off"/>
Output 3:	<input type="text" value="Off"/>
Output 4:	<input type="text" value="Off"/>

5.15 Printer Codes

PrtCod

With *PrtCod* displayed, press the **F3/ ↵** key. The display will change to *EndCh=*. Proceed to the *EndCh=* (End Character) parameter.

EndCh= (End Character)

Press the **F3/ ↵** key to show the current setting. To accept the setting displayed, press the **F3/ ↵** key again to save it. Otherwise, use the **F2/ ▲** and **F1/ ◀** keys to enter a new setting and then press the **F3/ ↵** key to save it. Allowable values for the End Character are: 0 through 255.

bC 1= through *bC 18=* (Begin Print Codes 1 through 18)

These are printer codes to send before ticket. Will prompt for up to 18 codes or until End Character code is reached.

Press the **F3/ ↵** key to show the current setting. To accept the setting displayed, press the **F3/ ↵** key again to save it. Otherwise, use the **F2/ ▲** and **F1/ ◀** keys to enter a new setting and then press the **F3/ ↵** key to save it. Allowable values for Begin Print Codes are: 0 through 255.

EC 1= through *EC 18=* (End Print Codes 1 through 18)

These are printer codes to send after ticket. Will prompt for up to 18 codes or until End Character code is reached.

Press the **F3/ ↵** key to show the current setting. To accept the setting displayed, press the **F3/ ↵** key again to save it. Otherwise, use the **F2/ ▲** and **F1/ ◀** keys to enter a new setting and then press the **F3/ ↵** key to save it. Allowable values for Begin Print Codes are: 0 through 255.

5.16 Print Tabs

tAb5

With *tAb5* displayed, press the **F3/ ↵** key. The display will change to *dt L =*. Proceed to the *dt L =* (Date Line Print Location) parameter.

The general format for the input is L = (the number of lines down) and C = (the number of columns to the right).

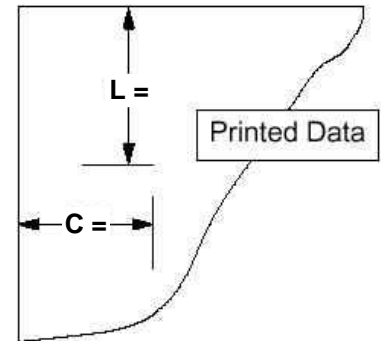

dt L = (Date Line Print Location)

Press the **F3/ ↵** key to show the current setting. To accept the setting displayed, press the **F3/ ↵** key again to save it. Otherwise, use the **F2/ ▲** and **F1/ ◀** keys to enter a new setting and then press the **F3/ ↵** key to save it. Allowable values are: 0 through 132.

dt C = (Date Column Print Location)

Press the **F3/ ↵** key to show the current setting. To accept the setting displayed, press the **F3/ ↵** key again to save it. Otherwise, use the **F2/ ▲** and **F1/ ◀** keys to enter a new setting and then press the **F3/ ↵** key to save it. Allowable values are: 0 through 132.

t L = (Time Line Print Location)

Press the **F3/ ↵** key to show the current setting. To accept the setting displayed, press the **F3/ ↵** key again to save it. Otherwise, use the **F2/ ▲** and **F1/ ◀** keys to enter a new setting and then press the **F3/ ↵** key to save it. Allowable values are: 0 through 132.

t C = (Time Column Print Location)

Press the **F3/ ↵** key to show the current setting. To accept the setting displayed, press the **F3/ ↵** key again to save it. Otherwise, use the **F2/ ▲** and **F1/ ◀** keys to enter a new setting and then press the **F3/ ↵** key to save it. Allowable values are: 0 through 132.

Gr L : (Gross Weight Line Print Location)

Press the **F3/ ↵** key to show the current setting. To accept the setting displayed, press the **F3/ ↵** key again to save it. Otherwise, use the **F2/▲** and **F1/◀** keys to enter a new setting and then press the **F3/ ↵** key to save it. Allowable values are: 0 through 132.

Gr C : (Gross Weight Column Print Location)

Press the **F3/ ↵** key to show the current setting. To accept the setting displayed, press the **F3/ ↵** key again to save it. Otherwise, use the **F2/▲** and **F1/◀** keys to enter a new setting and then press the **F3/ ↵** key to save it. Allowable values are: 0 through 132.

tR L : (Tare Weight Line Print Location)

Press the **F3/ ↵** key to show the current setting. To accept the setting displayed, press the **F3/ ↵** key again to save it. Otherwise, use the **F2/▲** and **F1/◀** keys to enter a new setting and then press the **F3/ ↵** key to save it. Allowable values are: 0 through 132.

tR C : (Tare Weight Column Print Location)

Press the **F3/ ↵** key to show the current setting. To accept the setting displayed, press the **F3/ ↵** key again to save it. Otherwise, use the **F2/▲** and **F1/◀** keys to enter a new setting and then press the **F3/ ↵** key to save it. Allowable values are: 0 through 132.

nR L : (Net Weight Line Print Location)

Press the **F3/ ↵** key to show the current setting. To accept the setting displayed, press the **F3/ ↵** key again to save it. Otherwise, use the **F2/▲** and **F1/◀** keys to enter a new setting and then press the **F3/ ↵** key to save it. Allowable values are: 0 through 132.

nR C : (Net Weight Column Print Location)

Press the **F3/ ↵** key to show the current setting. To accept the setting displayed, press the **F3/ ↵** key again to save it. Otherwise, use the **F2/▲** and **F1/◀** keys to enter a new setting and then press the **F3/ ↵** key to save it. Allowable values are: 0 through 132.

***C_n L* = (Consecutive Number Line Print Location)**

Press the **F3/ ↵** key to show the current setting. To accept the setting displayed, press the **F3/ ↵** key again to save it. Otherwise, use the **F2/ ▲** and **F1/ ◀** keys to enter a new setting and then press the **F3/ ↵** key to save it. Allowable values are: 0 through 132.

***C_n C* = (Consecutive Number Column Print Location)**

Press the **F3/ ↵** key to show the current setting. To accept the setting displayed, press the **F3/ ↵** key again to save it. Otherwise, use the **F2/ ▲** and **F1/ ◀** keys to enter a new setting and then press the **F3/ ↵** key to save it. Allowable values are: 0 through 132.

***gA_c L* = (Gross Accumulator Line Print Location)**

Press the **F3/ ↵** key to show the current setting. To accept the setting displayed, press the **F3/ ↵** key again to save it. Otherwise, use the **F2/ ▲** and **F1/ ◀** keys to enter a new setting and then press the **F3/ ↵** key to save it. Allowable values are: 0 through 132.

***gA_c C* = (Gross Accumulator Column Print Location)**

Press the **F3/ ↵** key to show the current setting. To accept the setting displayed, press the **F3/ ↵** key again to save it. Otherwise, use the **F2/ ▲** and **F1/ ◀** keys to enter a new setting and then press the **F3/ ↵** key to save it. Allowable values are: 0 through 132.

***nA_c L* = (Net Accumulator Line Print Location)**

Press the **F3/ ↵** key to show the current setting. To accept the setting displayed, press the **F3/ ↵** key again to save it. Otherwise, use the **F2/ ▲** and **F1/ ◀** keys to enter a new setting and then press the **F3/ ↵** key to save it. Allowable values are: 0 through 132.

***nA_c C* = (Net Accumulator Column Print Location)**

Press the **F3/ ↵** key to show the current setting. To accept the setting displayed, press the **F3/ ↵** key again to save it. Otherwise, use the **F2/ ▲** and **F1/ ◀** keys to enter a new setting and then press the **F3/ ↵** key to save it. Allowable values are: 0 through 132.

5.17 Test

tESt

With *tESt* displayed, press the **F3/ ↵** key. The display will change to *dSP=*. Proceed to the *dSP=* (Display Test) parameter.

dSP= (Display Test)

Press the **F3/ ↵** key to show the current setting. If the setting displayed is acceptable, press the **F3/ ↵** key again to save it. Otherwise, use the **F2/▲** key to toggle to a new setting and then press the **F3/ ↵** key to save it. Allowable settings are:

no Display Test is Disabled

With *no* displayed, press the **F3/ ↵** key. The display will change to *HrES*. Refer to section **5.18 Display High Resolution Weight** of this manual.

tESt Run Display Test

1. All horizontal segments will turn on and then off.
2. All vertical segments and decimal points will turn on and then off.
3. The status arrows will turn on and then off.
4. Each weight mode annunciator (lb, kg, etc.) will turn on and then off.
5. The model number 201 will be displayed.
6. The display will change to *HrES*. Refer to section **5.18 Display High Resolution Weight** of this manual.

rEv Show Display Revision

1. The display software version will be displayed.
2. The display will change to *HrES*. Refer to section **5.18 Display High Resolution Weight** of the manual.

MAC Show MAC Address

1. The MAC address will display as two screens such as "00:50:C2" then "88:E0:0E".
2. The display will change to *HrES*. Refer to section **5.18 Display High Resolution Weight** of the manual.

5.18 Display High Resolution Weight



IMPORTANT! The *H i r E S* mode requires a load of 10% of Capacity on the scale.

H i r E S

With *H i r E S* displayed, press the **F3/ ↵** key. The display will change to *H i r E S =*. Proceed to the *H i r E S =* (Display High Resolution) parameter.

H i r E S = (Display High Resolution)

1. With *H i r E S =* displayed, press the **F3/ ↵** key.
2. The display will change to *n 0*.
3. If you wish to skip high resolution weight display and return to the *S E T U P* mode, press the **F3/ ↵** key again.
4. Otherwise, place a calibrated test weight on the scale and press the **F2/ ▲** key to toggle to *W E S* and then press the **F3/ ↵** key.
5. The display will change to show the amount of the test weight in "high resolution" mode (1/10 division), and an H will be displayed to the right of the displayed weight.
6. Press the **F3/ ↵** key to exit the Display High Resolution Weight and return to the normal operation mode.

6. WEIGHT TRANSMITTER SETUP REVIEW

The Model 201 allows the metrological (Setup, Scale and Filter) parameters to be reviewed without breaking the calibration seal. The prompts will follow the same order as if the Calibration switch were pressed, but the values will be read only and cannot be changed.

6.1 Accessing Setup Review

SEtUP

1. With the weight transmitter ON, press the **F1/◀** key and the **F2/▲** key simultaneously.
2. The display will change to show *DATE* (the prompt to set the date and time).
3. Press the **F2/▲** key until the display changes to show *SEtUP* (the prompt to view the setup parameters).
4. With *SEtUP* displayed, press the **F3/↵** key.
5. To exit, press the **F3/↵** key to step through the remaining prompts *OR* at any time, cycle the power.
6. The weight transmitter will return to the normal weight display.

7. KEYPAD

7.1 Standard Key Functions

The Model 201 is equipped with a 6-key keypad. The keypad is used to enter commands and data into the weight transmitter. This section describes each key along with its normal function. It is helpful to refer to the actual weight transmitter while reading this section.



DO NOT operate the keypad with pointed objects (pencils, pens, etc.). Damage to keypad resulting from this practice is **NOT** covered under warranty.

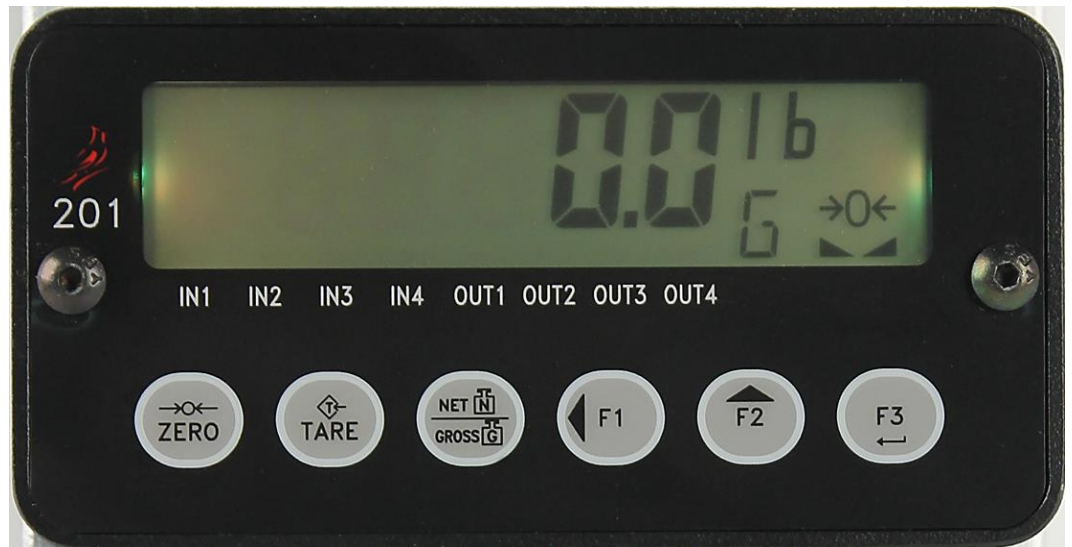
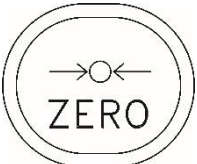

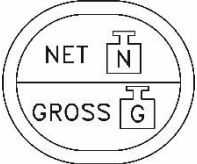
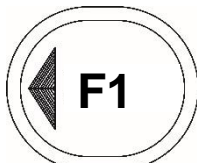

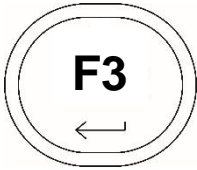

Figure No. 6

Key	Description
	<p>ZERO: The ZERO key is used to zero the weight display. Up to the selected limit of 4% or 100% of the scale's capacity can be zeroed. This limit is selected during the setup and calibration of the weight transmitter.</p> <p>Note that the weight transmitter will not respond to pressing the ZERO key unless the weight display is stable.</p>
	<p>TARE: The TARE key is used during normal operation to store the current Gross weight as the new Tare weight. The display will change to the Net weight and the Net annunciator will turn on.</p>
	<p>NET/GROSS: The NET/GROSS key is used to toggle between the Gross and Net weight modes. The selected mode is indicated by turning on the appropriate annunciator on the display.</p> <p>Note that if no valid tare weight has been entered, pressing the NET/GROSS key will cause a momentary display error (<i>n o t T a r e</i>) and the weight transmitter will remain in the Gross weight mode.</p>
	<p>F1/◀ (Left Arrow): The F1/◀ key is used for several functions.</p> <ul style="list-style-type: none"> • During setup, the F1/◀ key is used to advance the cursor left to the next position when inputting setup parameters. • In normal operation, the F1/◀ key is used to select the function it was assigned during the setup of the Preferences parameter. <p>For example, if it was assigned the UNITS function, it is used to select the units in which the weight is to be displayed. The available units of measure (primary or secondary units) are selected in setup. The available units include pounds, kilograms, and grams.</p>

Key	Description
 <p>The image shows a circular key with a double border. Inside the inner circle, there is an upward-pointing arrow above the text 'F2'.</p>	<p>F2/▲ (Up Arrow): The F2/▲ key is used for several functions.</p> <ul style="list-style-type: none"> • During weight transmitter setup, when a setup parameter (not a parameter value or setting) is displayed, pressing the F2/▲ key will "backup" to the previous parameter prompt. • Also during setup, when a parameter value or setting is displayed, pressing the F2/▲ key will "toggle" between the different available values or settings for that parameter. • In normal operation, the F2/▲ key is used to select the function it was assigned during the setup of the Preferences parameter. <p>For example, if it was assigned the PRINT function, pressing the F2/▲ key during a weighing operation, will add the displayed Gross weight, or Net weight to the associated accumulator and send print ticket data to the serial interface selected during setup.</p> <p>NOTE! The weight transmitter will not respond to pressing the F2/▲ key unless the weight display is stable.</p>
 <p>The image shows a circular key with a double border. Inside the inner circle, there is a left-pointing arrow above the text 'F3'.</p>	<p>F3/ ←(ENTER): The F3/ ←key is used for several functions.</p> <ul style="list-style-type: none"> • During Setup, pressing the F3/ ← key will display the current setting of the parameter. Pressing the F3/ ← key a second time (after changing parameter values or settings), signals completion of the entry of data and causes the weight transmitter to process the data entered. • In normal operation, the F3/ ←key is used to select the function it was assigned during the setup of the Preferences parameter. <p>For example, it could be assigned to function as the UNITS or PRINT key or could be disabled and not used.</p>

8. ANNUNCIATORS

8.1 Annunciators

The Model 201 is equipped with annunciators that are turned on to indicate that the display is in the mode corresponding to the annunciator label or that the status indicated by the label is active. This section describes each annunciator. Refer to Figure No. 13 for the location of the annunciators.

Symbol	Name	Description
→0←	ZERO	This annunciator is turned on to indicate that the weight displayed is within $\pm 1/4$ division of true zero.
▾▾	STABLE	This annunciator is turned on when the weight display is stable. When off, it means that the change in successive weight samples is greater than the motion limits selected during setup.
<i>N</i>	NET	This annunciator is turned on when the displayed weight is Net weight (Gross weight less Tare weight).
<i>G</i>	GROSS	This annunciator is turned on to show that gross weight is displayed. Gross weight will be displayed when no tare weight is stored.
<i>T</i>	TARE	This annunciator is turned on to show that the displayed weight is the tare weight.
lb	pounds	This annunciator is located to the right of the weight display and is turned on to show that the displayed weight unit is pounds.
oz	ounces	This annunciator is located to the right of the weight display and is turned on to show that the displayed weight unit is ounces.

Symbol	Name	Description
kg	kilograms	This annunciator is located to the right of the weight display and is used to indicate that the displayed unit of weight measurement is kilograms.
g	grams	This annunciator is located to the right of the weight display and is used to indicate that the displayed unit of weight measurement is grams.
▼ IN1	DIGITAL INPUT	This annunciator is used to signal that a digital input (the function it was assigned during the setup of the Digital Input/Output parameter) has been activated.
▼ IN2	DIGITAL INPUT	This annunciator is used to signal that a digital input (the function it was assigned during the setup of the Digital Input/Output parameter) has been activated.
▼ IN3	DIGITAL INPUT	This annunciator is used to signal that a digital input (the function it was assigned during the setup of the Digital Input/Output parameter) has been activated.
▼ IN4	DIGITAL INPUT	This annunciator is used to signal that a digital input (the function it was assigned during the setup of the Digital Input/Output parameter) has been activated.

Symbol	Name	Description
▼ OUT1	DIGITAL OUTPUT	This annunciator is used to signal that a digital output (the function it was assigned during the setup of the Digital Input/Output parameter) has been activated.
▼ OUT2	DIGITAL OUTPUT	This annunciator is used to signal that a digital output (the function it was assigned during the setup of the Digital Input/Output parameter) has been activated.
▼ OUT3	DIGITAL OUTPUT	This annunciator is used to signal that a digital output (the function it was assigned during the setup of the Digital Input/Output parameter) has been activated.
▼ OUT4	DIGITAL OUTPUT	This annunciator is used to signal that a digital output (the function it was assigned during the setup of the Digital Input/Output parameter) has been activated.

9. ERROR AND STATUS MESSAGES

9.1 Before You Call Service

The Model 201 Weight Transmitter has been designed to provide you with years of trouble-free operation. However, should you experience a problem, please refer to the troubleshooting guide below before you call for service. The following describes several types of symptoms along with suggested remedies.

PROBLEM	POSSIBLE SOLUTIONS
Display does not turn on	Check for 12 to 24 VDC
Incorrect weight displayed	Has the weight transmitter been calibrated? Insure that the scale platform isn't touching an adjacent object. Check the load cell connector wiring. If using four (4) wire load cells, insure the sense lead jumpers (J2, +SEN & J3, -SEN) are installed. Have proper operation procedures been followed?
Weight transmitter will not display weight	Refer to Error and Status Codes section and make certain that the "O.C.P." message is not displayed. If so, and scale is not loaded, perform the calibration procedure.

9.2 Error and Status Codes

The Model 201 Weight Transmitter is equipped with software that indicates when an error in the operation takes place. The following lists the error and status codes displayed by the 201 along with their meaning. Should you encounter a code, please refer to this list.

Error	Meaning
<i>CALib</i>	Calibration required
<i>Err H</i>	The analog input signal is high
<i>Err L</i>	The analog input signal is low
<i>oCAP</i>	The load on the scale exceeds the capacity of the scale
<i>SrArrn</i>	SRAM error detected during startup
<i>CALib</i>	EEPROM CRC error detected during startup – settings will revert to default
<i>E tAbL</i>	Waiting for Ethernet
<i>dHCP</i>	Network configured for Dynamic Host Configuration Protocol
<i>dHCP b</i>	During dHCP binding
<i>StAt iC</i>	Network configured for static IP address
<i>P1:</i>	First part of IP address (<u>##</u> . # . # . ## - e.g., <u>90</u> .1.2.68)
<i>P2:</i>	Second part of IP address (<u>##</u> . <u>#</u> . # . ## - e.g., 90. <u>1</u> .2.68)
<i>P3:</i>	Third part of IP address (<u>##</u> . # . <u>#</u> . ## - e.g., 90.1. <u>2</u> .68)
<i>P4:</i>	Fourth part of IP address (<u>##</u> . # . # . <u>##</u> - e.g., 90.1.2. <u>68</u>)
<i>USb</i>	Running on USB power
<i>boot</i>	Boot loader mode
<i>notArE</i>	Attempt to select Gross/Net to show Net weight when there is no tare weight
<i>UnStb</i>	Attempt to print with unstable weight
<i>Error m</i>	Attempt to zero with motion
<i>Error 0</i>	Attempt to zero with over capacity
<i>Error r</i>	Attempt to zero out of range
<i>Error d</i>	Too many divisions configured for Legal For Trade

10. EVENT COUNTERS

A Category 1 Event Counter is provided on the 201 with two counters that increment when a change is made to features that are required by NTEP or OIML to be sealed. One counter is designated for calibration (metrological) parameters and one is designated for configuration (non- metrological) changes as required in NCWM Publication 14, 2007. Each event counter has a capacity to record 99999 changes.

The data for the counters is maintained in non-volatile memory and can be viewed by a weights and measures inspector. When selected, the display will show the number of changes to the Configuration and the Calibration counters.

CFG: **(Configuration Counter)**

The configuration counter is incremented when a value in the non-meteorological part of setup is changed. The counter is only incremented 1 time even if more than one parameter is changed each time through setup. The value displayed will be between 0 and 99999.

CAL: **(Calibration Counter)**

The calibration counter is incremented when a value in the meteorological part of setup is changed. The counter is only incremented 1 time even if more than one parameter is changed each time through setup. The value displayed will be between 0 and 99999.

10.1 Accessing the Event Counters

E t r

1. With the weight transmitter ON, press the **F1/◀** key and the **F2/▲** key simultaneously.
2. The display will change to show *dRtE* (the prompt to set the date and time).
3. Press the **F2/▲** key. The display will change to show *E t r* (the prompt to view the event counters).
4. With *E t r* displayed, press the **F3/↵** key. The display will change to *[F9]* (the prompt to view the Configuration Counter).
5. Press the **F3/↵** key to show the current value of the configuration counter.
6. Press the **F3/↵** key again. The display will change to *[RL]* (the prompt to view the Calibration Counter).
7. Press the **F3/↵** key to show the current value of the calibration counter.
8. To exit press the **F3/↵** key to step through the remaining prompts *OR* at any time, cycle the power.
9. The weight transmitter will return to the normal weight display.

11. DIGITAL FILL CONTROL

11.1 Operation

Start

Once all of the settings have been entered for the 201 DFC, the filling process can be started by pressing the **F-Key** associated with “Start/Pause” or by activating the input associated with “Start/Pause”, or by using the communication port commands (see **11.3 Communication Port Control** section).

Pause

While filling or discharging, the system can be paused by activating the “Start/Pause” **F-Key** or input at any time. While paused, the indicator will disable any active outputs and await restarting or cancelling by the operator or controlling system.

Resume

While paused, the indicator can resume from where it left off by activating the “Start/Pause” **F-Key** or input.

Cancel

While paused, the current batch may be cancelled by activating the “Discharge” **F-Key** or input. Please note that this will perform a discharge cycle before resetting the 201 DFC to the idle state.

Discharge

After filling is complete, if the Auto Dump feature is enabled, the 201 DFC system should discharge automatically. If Auto Dump is disabled, activating the “Discharge” **F-Key** or input will cause a discharge cycle to occur.

11.2 Output Assigning

In order to make the DFC as flexible as possible, the output assignments use a binary scheme of 4 bits in order to define the outputs used for the filling and discharging. The least significant bit is associated with output 1 and the most significant bit is associated with output 4. See the truth table below to determine the proper setting to drive the desired outputs:

Parameter Value	OUT1 Status	OUT2 Status	OUT3 Status	OUT4 Status
0	Off	Off	Off	Off
1	On	Off	Off	Off
2	Off	On	Off	Off
3	On	On	Off	Off
4	Off	Off	On	Off
5	On	Off	On	Off
6	Off	On	On	Off
7	On	On	On	Off
8	Off	Off	Off	On
9	On	Off	Off	On
10	Off	On	Off	On
11	On	On	Off	On
12	Off	Off	On	On
13	On	Off	On	On
14	Off	On	On	On
15	On	On	On	On

Example:

To set a dual speed system for AB->B type operation, the following output assignments could be used.

Fast Output = 3 (both outputs 1 and 2 activated while fast filling)

Slow Output = 2 (only output 2 activated while slow filling)

Example 2:

To set a dual speed system for A->B type operation, the following output assignments could be used.

Fast Output = 1 (only output 1 active during fast filling)

Slow Output = 2 (only output 2 active during slow filling)

11.3 Communication Port Control

The 201 DFC settings and operation can be controlled through the raw Ethernet port, USB, or serial port of the indicator when those ports are set to “On Demand” type of operation. All of the commands use the SMA style of format and will start with a linefeed character (hex 0A) and end with a carriage return character (hex 0D).

Key to symbols used:

<LF> = linefeed character (hex 0A)

<CR> = carriage return character (hex 0D)

Following is a list of allowed commands with descriptions of the commands and their formats:

Set Output State: Sets the state of the output

Command Format: <LF>XOUTn=s<CR>

Where:

n = number of output to control (1-4)

s = state to drive the output (0 = off, 1 = on)

Response: N/A

Get Output State: Gets the current state of all outputs

Command Format: <LF>XOUT<CR>

Response: <LF>XOUT(1-4)=abcd<CR>

Where:

a = output 1 status (0 or 1)

b = output 2 status (0 or 1)

c = output 3 status (0 or 1)

d = output 4 status (0 or 1)

Get Input State: Gets the current state of the selected input

Command Format: <LF>XINn<CR>

Where:

n = Input number to request state (1 – 4)

Response: <LF>XINn=s<CR>

Where:

n = Input number requested (1 – 4)

s = Input status (0 = off, 1 = on)

Set Fast Target: Sets the fast target weight to fill to

Command Format: <LF>XTARGETFAST=n<CR>

Where:

n = Target weight (0 to capacity)

Response: N/A

Set Slow Target: Sets the slow target weight to fill to

Command Format: <LF>XTARGETSLOW=n<CR>

Where:

n = Target weight (0 to capacity)

Response: N/A

Set Fast Output: Sets the output(s) to use for fast filling

Command Format: <LF>XOUTFAST=n<CR>

Where:

n = 0 – 15 (see Output Assigning above)

Response: N/A

Set Slow Output: Sets the output(s) to use for slow filling

Command Format: <LF>XOUTSLOW=n<CR>

Where:

n = 0 – 15 (see Output Assigning above)

Response: N/A

Set Discharge Output: Sets the output(s) to use for discharging

Command Format: <LF>XOUTDISCHARGE=n<CR>

Where:

n = 0 – 15 (see Output Assigning above)

Response: N/A

Set Trim Value: Sets the current trim value

Command Format: <LF>XTRIM=n<CR>

Where:

n = Trim weight (0 to Target)

Response: N/A

Start/Pause/Resume Filling: Starts/Pauses/Resumes the filling cycle

Command Format: <LF>XSTART<CR>

Response: N/A

Discharge: Starts the discharge cycle

Command Format: <LF>XDISCHARGE<CR>

Response: N/A

12. 201 ADMIX SYSTEM

12.1 Introduction

This section will describe the added features and configuration of the 201 Admix system. Included in this reference are the additional setup prompts and their configuration, as well as a description of the operation of the 201 Admix system.

12.2 Setup and Configuration

The 201 Admix application has the following additional setup prompts and configuration in addition to the standard 201 setup and configuration. These configuration parameters can be accessed either through the web configuration, or using the 201 display through the Digital Fill Control setup group.

dFL

With *dFL* displayed, press the **F3/ ←** key. The display will change to *dFL =*. Proceed to the *dFL =* (Enable Digital Fill Control) parameter.

dFL = (Select Digital Fill Control Mode)

This setting determines the usage of the outputs of the 201 Admix controller.

Press the **F3/ ←** key to show the current setting. If the setting displayed is acceptable, press the **F3/ ←** key again to save it. Otherwise, use the **F2/▲** key to toggle to a new setting and then press the **F3/ ←** key to save it. Allowable settings are:

- | | |
|-------------|--|
| <i>oFF</i> | oFF (output 1 will be the “At Zero” output and output 2 will be the “Pulse” output) |
| <i>dI o</i> | DIO (output 1 will be the “Fill” output and output 2 will be the “Discharge” output) |

FAST = **(Fast Target)**

This is the filling target that the 201 Admix is set to fill to.

NOTE: If the DFC Mode is set to “Off” this prompt is replaced with the At Zero Delay (*0-DEL* on display). The At Zero Delay is how many seconds that the 201 will wait upon going below the zero threshold before setting the At Zero Output active.

Press the **F3/ ↵** key to show the current setting. If the setting displayed is acceptable, press the **F3/ ↵** key again to save it. Otherwise, use the **F2/ ▲** and **F1/ ◀** keys to enter a new setting and then press the **F3/ ↵** key to save it. Allowable values for Fast Target are: 0 through scale capacity.

Pulse = **(Pulse Target)**

This is the amount of weight at which the 201 Admix system will output a pulse on output 2 every change in weight of this amount.

For instance, if the Pulse Target is set to 1.0 (lb), then the 201 Admix controller will pulse output 2 every time the weight changes 1 lb (up or down).

NOTE: If the DFC Mode is set to DIO operation, this setting is ignored as no pulse will be generated when in DIO mode.

Press the **F3/ ↵** key to show the current setting. If the setting displayed is acceptable, press the **F3/ ↵** key again to save it. Otherwise, use the **F2/ ▲** and **F1/ ◀** keys to enter a new setting and then press the **F3/ ↵** key to save it. Allowable values for Pulse Target are from 0 (zero = off, no pulse generated) to capacity of the scale.

PULS = (Pulse Width)

This setting sets the width of the generated pulse (see Pulse Target above) in milliseconds. To generate a 1 millisecond pulse, a value of '1' should be entered, for a 10 millisecond pulse, a value of '10' should be entered, etc.

NOTE: If the DFC Mode is set to DIO operation, this setting is ignored as no pulse will be generated when in DIO mode.

Press the **F3/ ←** key to show the current setting. If the setting displayed is acceptable, press the **F3/ ←** key again to save it. Otherwise, use the **F2/▲** and **F1/◀** keys to enter a new setting and then press the **F3/ ←** key to save it. Allowable values for this parameter are from 1 to 100.

טרימ (Trim)

This setting controls the trim value of the filling process. This is the amount of weight below the actual target value at which the output will be deactivated in order to accurately arrive at the target weight.

NOTE: If the DFC Mode is set to "Off" then this setting is not applicable.

Press the **F3/ ←** key to show the current setting. If the setting displayed is acceptable, press the **F3/ ←** key again to save it. Otherwise, use the **F2/▲** and **F1/◀** keys to enter a new setting and then press the **F3/ ←** key to save it. Allowable values for this are from 0 to Fast Target.

0-טול = (Zero Tolerance)

If **Autod=YES**, the completed fill operation will immediately discharge. The discharge will continue until the scale weight returns to zero within the **0-טול = (Zero Tolerance)** value.

Press the **F3/ ←** key to show the current setting. If the setting displayed is acceptable, press the **F3/ ←** key again to save it. Otherwise, use the **F2/▲** and **F1/◀** keys to enter a new setting and then press the **F3/ ←** key to save it.

dytcr = **(Dynamic Trim)**

This setting controls whether the 201 Admix application will dynamically adjust the Trim value based on overshoot/undershoot of each fill. This can be used to 'learn' the proper trim value. Once a trim value has been 'learned', which usually takes between 3 and 10 filling cycles, it is recommended to turn off dynamic trim..

NOTE: If the DFC Mode is set to "Off" then this setting is not applicable.

Press the **F3/ ↵** key to show the current setting. If the setting displayed is acceptable, press the **F3/ ↵** key again to save it. Otherwise, use the **F2/ ▲** and **F1/ ◀** keys to enter a new setting and then press the **F3/ ↵** key to save it.

Autod = **(Auto Dump)**

This setting controls whether the 201 Admix will automatically discharge after filling or waits for input from the operator or other controlling system..

NOTE: If the DFC Mode is set to "Off" then this setting is not applicable.

Press the **F3/ ↵** key to show the current setting. If the setting displayed is acceptable, press the **F3/ ↵** key again to save it. Otherwise, use the **F2/ ▲** key to toggle to a new setting and then press the **F3/ ↵** key to save it. Allowable settings are:

- | | |
|------------|-----------------------|
| <i>no</i> | no (Manual Discharge) |
| <i>YES</i> | YES (Auto Discharge) |

AutoP: (Automatic Print)

This setting controls whether the 201 Admix will automatically print on all ports set to printer output upon reaching a stable target weight.

NOTE: If the DFC Mode is set to “Off” then this setting is not applicable.

Press the **F3/ ←** key to show the current setting. If the setting displayed is acceptable, press the **F3/ ←** key again to save it. Otherwise, use the **F2/▲** key to toggle to a new setting and then press the **F3/ ←** key to save it. Allowable settings are:

- no no (No Automatic Print)
- YES YES (Automatic Print after stable target weight)

Pulse Output Operation Information and Recommendations

Pulse output operation is enabled when DFC Mode is set to off and the Pulse Target setting is greater than zero. A pulse will ONLY be generated for every positive increment of the Pulse Target. Upon power up, the 201 Admix system will calculate an offset if the scale does not power up at zero weight. This offset will be used to calculate Pulse Target increments until the scale is zeroed. Once zeroed, the scale will reset the increments so that they start from zero instead of the initial offset. For this reason, it is recommended that the scale be zeroed before each filling operation when the pulse output is used by a controller that is driving the I/O to guarantee the most accurate count of pulses in a particular filling cycle.

At Zero Output Operation

The “at-zero” output will be activated when the scale goes below the zero tolerance amount and will remain active. If At Zero Delay (*0-DEL* on display) is set to something other than zero, then the indicator will pause for the allotted time before activating the output. Refer to the *FAST:* (Fast Target) parameter.

12.3 Web Page Configuration

Below is a screen capture of the 201 Admix settings as found on the web configuration page with DFC set to “Off” (Pulse output mode).

Cardinal Scale Manufacturing Company

Home	Digital Fill Control
Event Counters	DFC: <input type="text" value="Off"/>
Settings	At Zero Delay: <input type="text" value="5.00000"/>
Date/Time	Pulse Target: <input type="text" value="1.00250"/>
Accumulators	Pulse width(ms): <input type="text" value="50"/>
Setup	DFC Trim: <input type="text" value="0.15000"/>
Weighing Input	DFC Zero Tolerance: <input type="text" value="1.00000"/>
Filter	DFC Dynamic Trim: <input type="text" value="No"/>
Ethernet	DFC Auto Dump: <input type="text" value="No"/>
USB	DFC Auto Print: <input type="text" value="No"/>
Serial Port	<input type="button" value="Submit"/>
Print Codes	
Print Tabs	
Digital I/O	
Analog I/O	
Storage Memory	
Check Weigh	
Preferences	
Flow Rate	
Digital Fill Control	
Diagnostics	
Log file	

Below is a screen capture of the 201 Admix settings as found on the web configuration page with DFC set to “DIO” (Fill control mode).

Cardinal Scale Manufacturing Company

Home	<h3>Digital Fill Control</h3> <hr/> <p>DFC: <input type="text" value="DIO"/></p> <p>Fast Target: <input type="text" value="5.00000"/></p> <p>Pulse Target: <input type="text" value="1.00250"/></p> <p>Pulse width(ms): <input type="text" value="50"/></p> <p>DFC Trim: <input type="text" value="0.15000"/></p> <p>DFC Zero Tolerance: <input type="text" value="1.00000"/></p> <p>DFC Dynamic Trim: <input type="text" value="No"/></p> <p>DFC Auto Dump: <input type="text" value="No"/></p> <p>DFC Auto Print: <input type="text" value="No"/></p> <p><input type="button" value="Submit"/></p>
Event Counters	
Settings	
Date/Time	
Accumulators	
Setup	
Weighing Input	
Filter	
Ethernet	
USB	
Serial Port	
Print Codes	
Print Tabs	
Digital I/O	
Analog I/O	
Storage Memory	
Check Weigh	
Preferences	
Flow Rate	
Digital Fill Control	
Diagnostics	
Log file	

The other settings that have been added in order to facilitate the use of the 201 Admix application are to the Preferences and to the DIO setup. In order to facilitate use of the 201 Admix, F-Key button assignments for “Settings”, “Start/Pause”, and “Discharge” have been added.

Cardinal Scale Manufacturing Company

Home	Preferences
Event Counters	Language: English ▾
Settings	Date Order: Month/Day/Year ▾
Date/Time	Time 12 Hour: No ▾
Accumulators	F1 Key Assign: DFC presets ▾
Setup	F2 Key Assign: DFC Start/Pause ▾
Weighing Input	F3 Key Assign: DFC Discharge ▾
Filter	Default Color: Blue ▾
Ethernet	<input type="button" value="Submit"/>
USB	
Serial Port	
Print Codes	
Print Tabs	
Digital I/O	
Analog I/O	
Storage Memory	
Check Weigh	
Preferences	
Flow Rate	
Digital Fill Control	
Diagnostics	
Log file	

Also, to allow for remote push-button operation, similar settings have been added for the 201 input assignments.

Cardinal Scale Manufacturing Company

Home	<h3>Digital I/O</h3> <hr/> <p>Input 1: <input type="text" value="DFC Start"/> ▼</p> <p>Input 2: <input type="text" value="DFC Discharge"/> ▼</p> <p>Input 3: <input type="text" value="Off"/> ▼</p> <p>Input 4: <input type="text" value="Off"/> ▼</p> <p>Output 1: <input type="text" value="Off"/> ▼</p> <p>Output 2: <input type="text" value="Off"/> ▼</p> <p>Output 3: <input type="text" value="Off"/> ▼</p> <p>Output 4: <input type="text" value="Off"/> ▼</p> <p><input type="button" value="Submit"/></p>
Event Counters	
Settings	
Date/Time	
Accumulators	
Setup	
Weighing Input	
Filter	
Ethernet	
USB	
Serial Port	
Print Codes	
Print Tabs	
Digital I/O	
Analog I/O	
Storage Memory	
Check Weigh	
Preferences	
Flow Rate	
Digital Fill Control	
Diagnostics	
Log file	

12.4 Operation

Start

Once all of the settings have been entered for the 201 Admix, the filling process can be started by pressing the **F**-Key associated with “Start/Pause” or by activating the input associated with “Start/Pause”, or by using the communication port commands (see **12.5 Communication Port Control** section).

Pause

While filling or discharging, the system can be paused by activating the “Start/Pause” **F**-Key or input at any time. While paused, the indicator will disable any active outputs and await restarting or cancelling by the operator or controlling system.

Resume

While paused, the indicator can resume from where it left off by activating the “Start/Pause” **F**-Key or input.

Cancel

While paused, the current batch may be cancelled by activating the “Discharge” **F**-Key or input. Please note that this will perform a discharge cycle before resetting the 201 Admix to the idle state.

Discharge

After filling is complete, if the Auto Dump feature is enabled the 201 Admix system should discharge automatically. If Auto Dump is disabled, activating the “Discharge” **F**-Key or input will cause a discharge cycle to occur.

12.5 Communication Port Control

The 201 Admix settings and operation can be controlled through the raw Ethernet port, USB, or serial port of the indicator when those ports are set to “On Demand” type of operation. All of the commands use the SMA style of format and will start with a linefeed character (hex 0A) and end with a carriage return character (hex 0D).

Key to symbols used:

<LF> = linefeed character (hex 0A)

<CR> = carriage return character (hex 0D)

Following is a list of allowed commands with descriptions of the commands and their formats:

Set Output State: Sets the state of the output

Command Format: <LF>XOUTn=s<CR>

Where:

n = number of output to control (1-4)

s = state to drive the output (0 = off, 1 = on)

Response: N/A

Get Output State: Gets the current state of all outputs

Command Format: <LF>XOUT<CR>

Response: <LF>XOUT(1-4)=abcd<CR>

Where:

a = output 1 status (0 or 1)

b = output 2 status (0 or 1)

c = output 3 status (0 or 1)

d = output 4 status (0 or 1)

Get Input State: Gets the current state of the selected input

Command Format: <LF>XINn<CR>

Where:

n = Input number to request state (1 – 4)

Response: <LF>XINn=s<CR>

Where:

n = Input number requested (1 – 4)

s = Input status (0 = off, 1 = on)

Set Fill Target: Sets the target weight to fill to

Command Format: <LF>XTARGET=n<CR>

Where:

n = Target weight (0 to capacity)

Response: N/A

Set Trim Value: Sets the current trim value

Command Format: <LF>XTRIM=n<CR>

Where:

n = Trim weight (0 to Target)

Response: N/A

Start/Pause/Resume Filling: Starts/Pauses/Resumes the filling cycle

Command Format: <LF>XSTART<CR>

Response: N/A

Discharge: Starts the discharge cycle

Command Format: <LF>XDISCHARGE<CR>

Response: N/A

Set Pulse Width: Sets the pulse width in milliseconds

Command Format: <LF>XPULSEWIDTH=n<CR>

Where:

n = desired pulse width in milliseconds (1 – 100)

Response: N/A

Set Pulse Target: Sets the change in weight amount to generate a pulse

Command Format: <LF>XPULSETARGET=n<CR>

Where:

n = desired pulse target (0 = off, to capacity)

Response: N/A

13. LEAD AND WIRE SECURITY SEAL INSTALLATION

If your Model 201 Weight Transmitter is used in a commercial application it must be tested and sealed by your local weights and measurements official. The 201 is designed to accept a lead and wire security seal to prevent unauthorized access to the Metrological Parameters. Refer to Figure No. 7 for details on the installation of the seal.

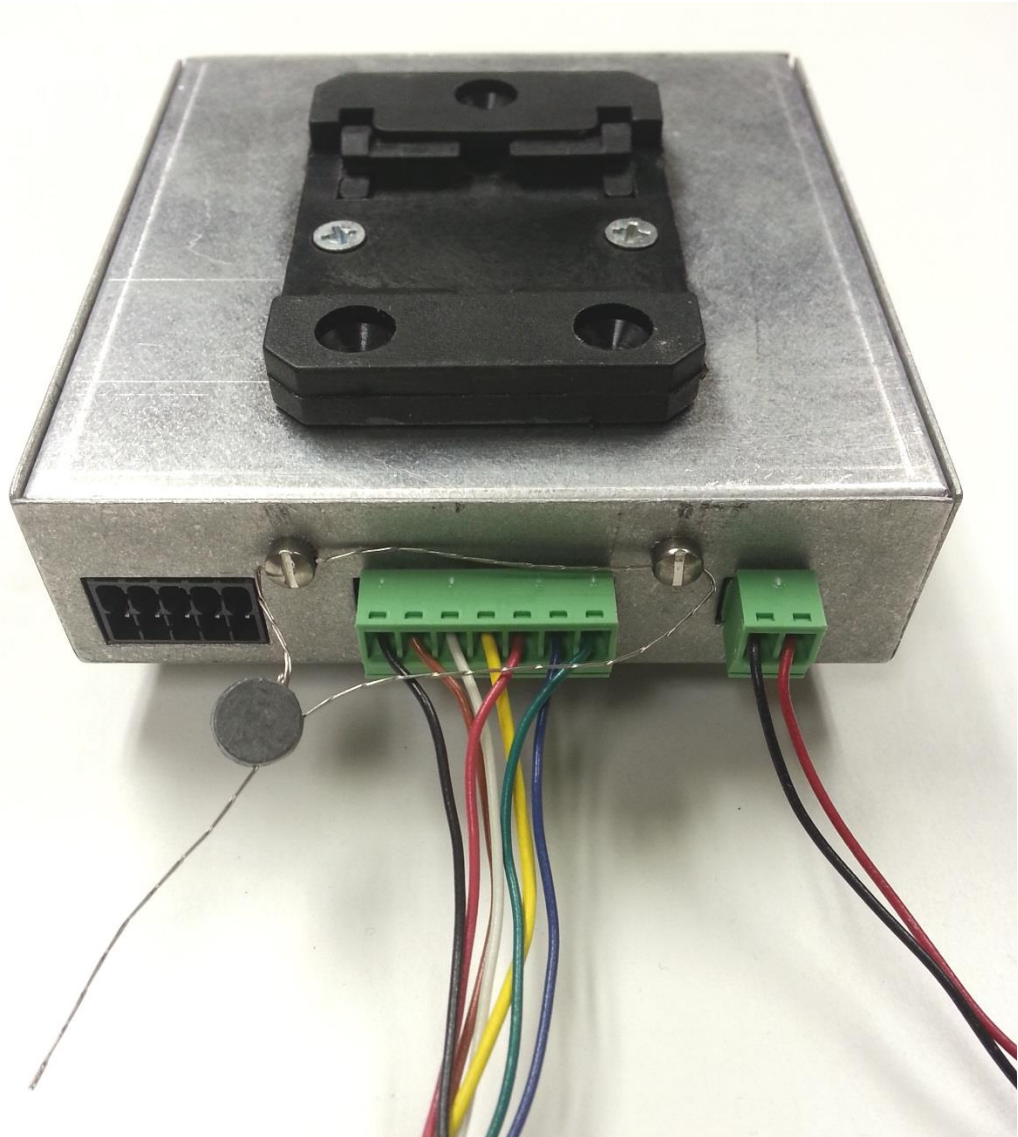

Figure No. 7

14. DIAGNOSTICS WEB PAGE

The 201 Diagnostics Web Page is available when *SETUP* is enabled. When *SETUP* is enabled (calibration switch has been pressed), the information and buttons at the bottom of the screen seen on the next page will be shown.

14.1 Steps to Import

1. Click on the Choose File button and select a 201 settings export file which should be named “config.201” (if after exporting the settings the name wasn’t changed).
2. Click on Send
3. The indicator will receive the settings file, validate it and should return to the Home screen.

14.2 Steps to Export

1. Click on Export, this will start a download of a file “config.201” which contains the indicator settings in binary encoded format which is NOT human readable or editable.

14.3 Steps to Reset to Factory Defaults

1. Click on Reset All Settings. This will open a dialog confirmation box.
2. Click on Accept in the dialog confirmation box to return the indicator to factory defaults.

Below is a screen capture of the 201 Diagnostics Web Page.

Cardinal Scale Manufacturing Company

Home	201 Diagnostics
Event Counters	Date/Time 11/18/2014 13:53:26
Settings	Primary RAM
Date/Time	Static RAM used 24256 bytes
Accumulators	Peak RAM usage 65540 bytes (50%)
Setup	Current RAM free 56608 bytes (43%)
Weighing Input	Secondary RAM
Filter	Current RAM free 242448 bytes (92%)
Ethernet	Network
USB	MAC Address: 00:50:C2:88:E5:6B
Serial Port	Socket Type Rcv Snd Errs
Print Codes	1FFF8E80 CFG UDP 0 0 0
Print Tabs	
Digital I/O	Click on Choose File to choose a configuration file (config.201).
Analog I/O	Click on the Send button to upload configuration.
Storage Memory	Import Configuration: <input type="button" value="Choose File"/> No file chosen
Check Weigh	<input type="button" value="Send"/>
Preferences	
Flow Rate	<input type="button" value="Export"/>
Digital Fill Control	<input type="button" value="Reset All Settings"/>
Diagnostics	
Log file	

15. PARTS IDENTIFICATION

15.1 Parts List (All Views)

ITEM NO.	QTY.	PART NUMBER	DESCRIPTION
1	1	593GR986	SERIAL TAG ASSY
2	6	6021-0654	SCW PAN-HEAD. MACHINE-SCW 06-32X 0.25
3	2	6021-2071	SCW FILLISTER. MACHINE-SCW 06-32X.25
4	2	6021-2045	SCW FLAT-HEAD. MACHINE-SCW 06-32X.625
5	1	6600-1243	DIN RAIL MOUNTING CLIP, BLACK
6	8	6680-0004	WASHER LOCK INT TOOTH #6 TYPE A Z-PL
7	1	8400-B105-0A	INTERNAL DISPLAY CABLE
8	1	8400-C112-08	BASE, INNER BOX
9	1	8400-C120-0A	FRONT PANEL REMOTE DISPLAY
10	1	8400-D100-0A	201 CONTROLLER BOARD
11	1	8400-D113-08	COVER, INNER BOX

15.1.1 201 Terminal Block Connectors*

QTY.	PART NUMBER	DESCRIPTION
1	6610-1548	P2 – 10-pin ISO I/O Terminal Block Connector
1	6610-1546	P7 – 2-pin Power Terminal Block Connector
1	6610-1554	P8 – 7-pin Load Cell Terminal Block Connector
1	6610-1548	P9 – 10-pin Serial & Analog I/O Terminal Block Connector

* Not shown.

15.2 Front and Back Views

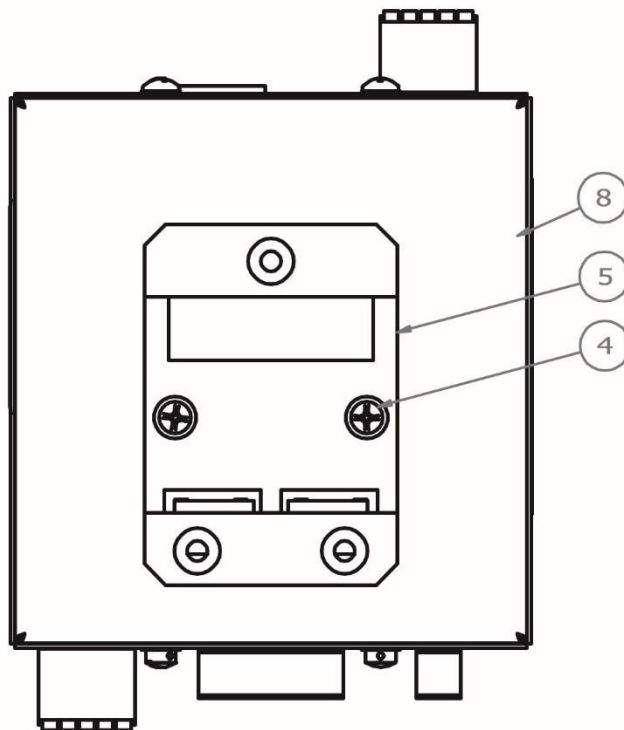
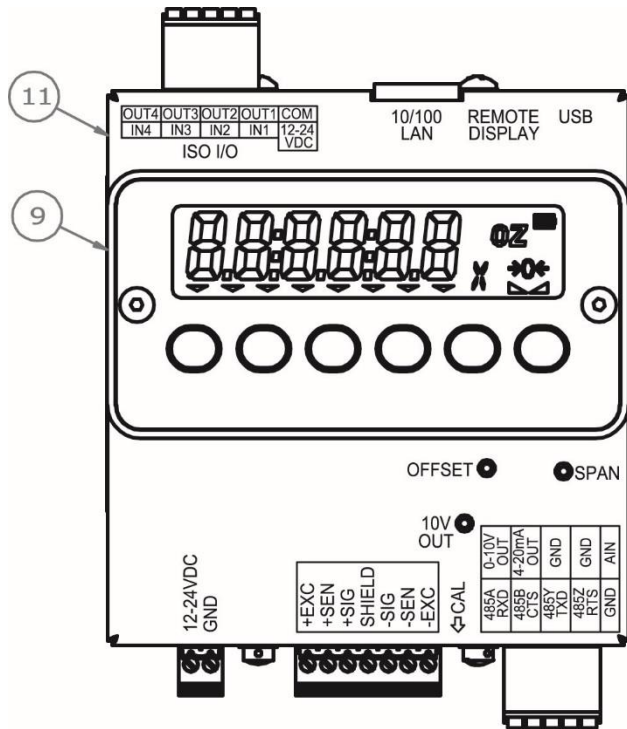

15.3 Side and End Views

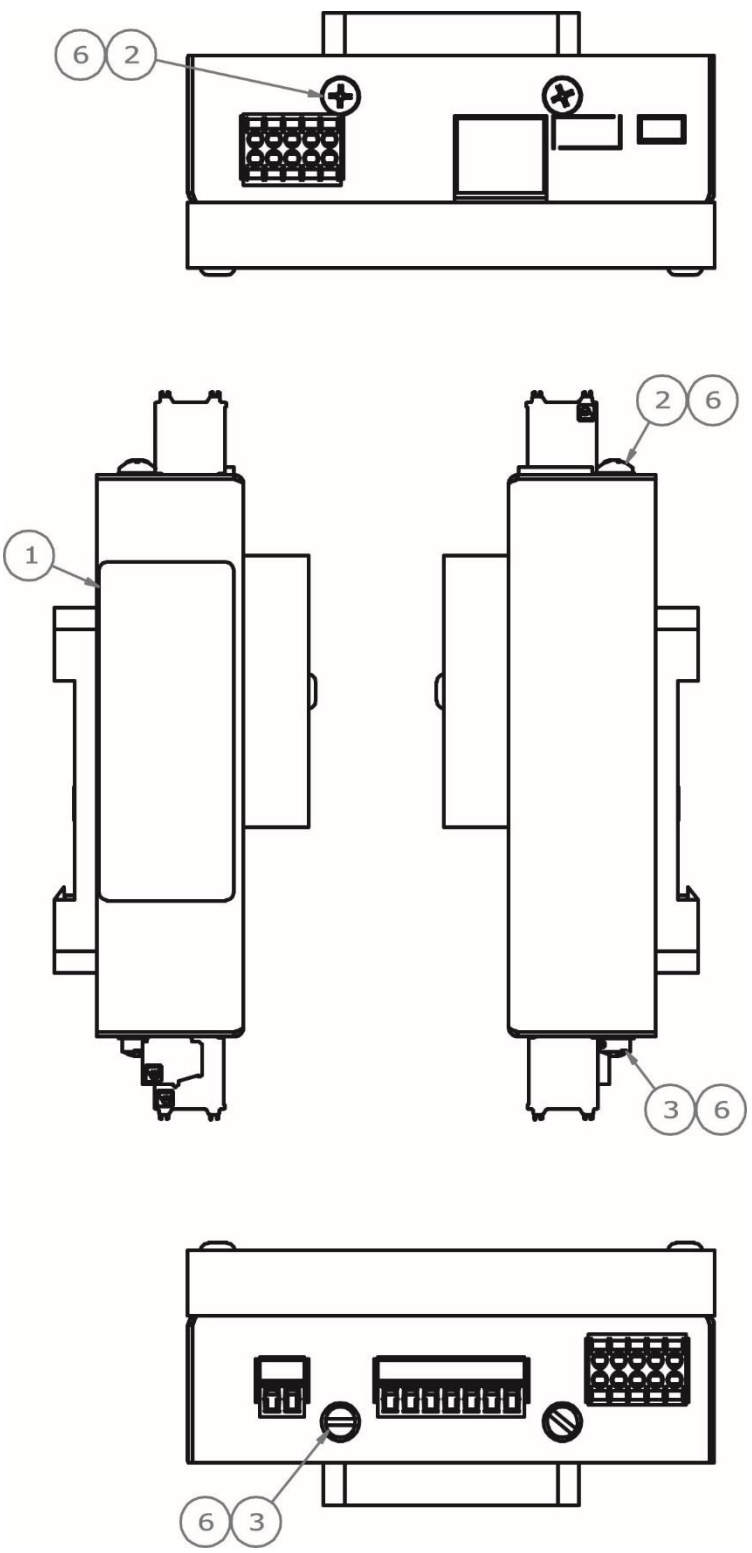

15.4 Internal Views

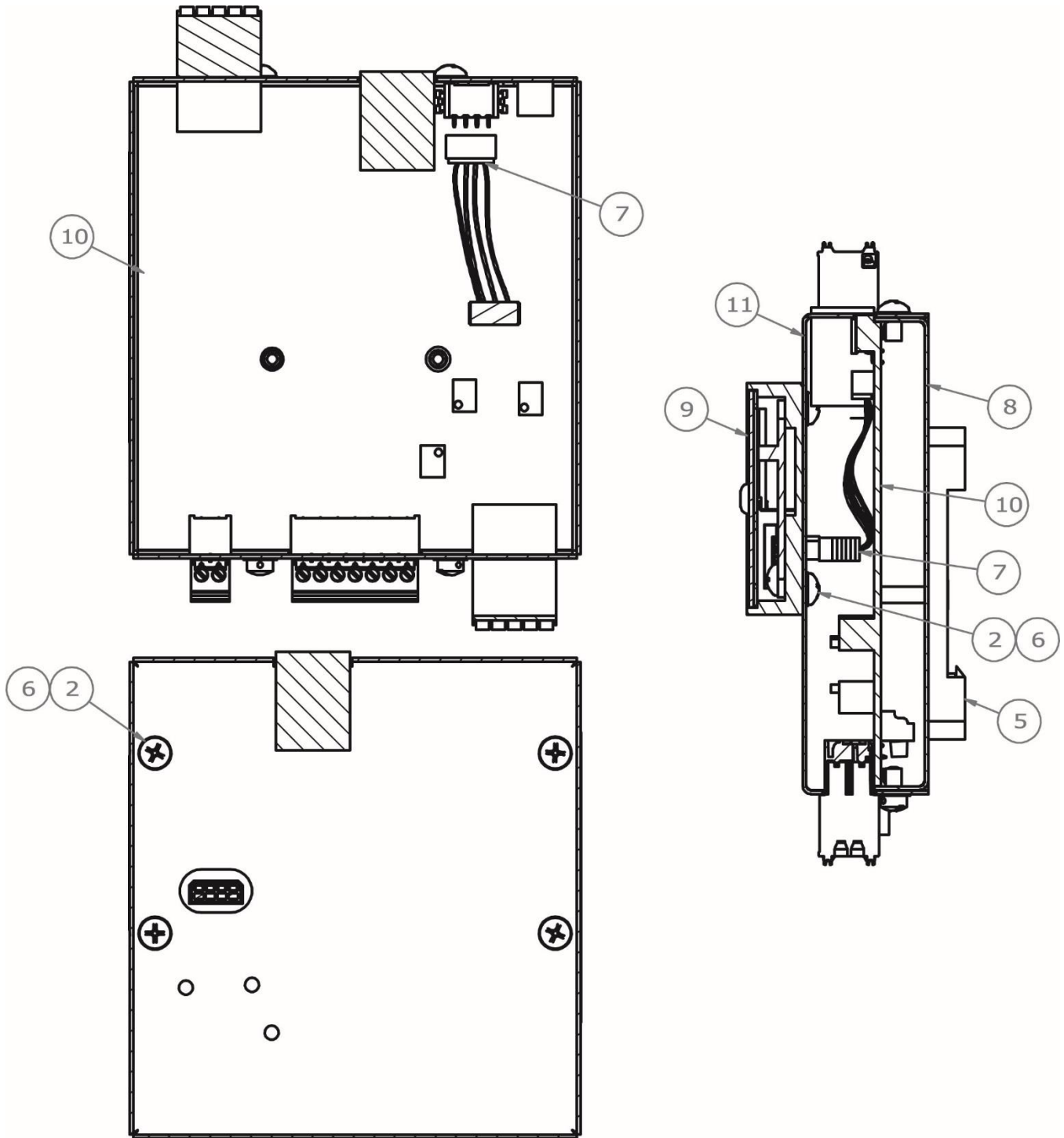

STATEMENT OF LIMITED WARRANTY

WARRANTY TERMS

Cardinal Scale Manufacturing Company warrants the equipment we manufacture against defects in material and workmanship. The length and terms and conditions of these warranties vary with the type of product and are summarized below:

PRODUCT TYPE	TERM	MATERIAL AND WORKMANSHIP	LIGHTNING DAMAGE See note 9	WATER DAMAGE See note 7	CORROSION See note 4	ON-SITE LABOR	LIMITATIONS AND REQUIREMENTS
WEIGHT INDICATORS	90 DAY REPLACEMENT ----- 1 YEAR PARTS	YES	YES	YES	YES	NO	1, 2, 3, 5, 6 A, B, C, D
LOAD CELLS (Excluding Hydraulic)	1 YEAR	YES	YES	YES	YES	NO	1, 2, 3, 5, 6 A, B, C, D
HYDRAULIC LOAD CELLS (When purchased with Guardian Vehicle Scale)	LIFE	YES	YES	YES	YES	90 DAYS	1, 5, 6, 8 A, B, C, D
HYDRAULIC LOAD CELLS (When purchased separately)	10 YEARS	YES	YES	YES	YES	NO	1, 5, 6, 8, 9 A, B, C, D
VEHICLE SCALE (Deck and Below Excl. PSC Series)	5 YEARS	YES	YES	YES	YES	90 DAYS	1, 2, 3, 5, 6 A, B, C, D, E
PSC and LSC SCALE STRUCTURES (Deck and Below)	3 YEARS	YES	YES	YES	YES	90 DAYS	1, 2, 3, 5, 6, 11 A, B, C, D
GUARDIAN FLOOR SCALES	10 YEARS	YES	YES	YES	YES	NO	1, 2, 3, 5, 6, 9, 10 A, B, C, D
ALL OTHER CARDINAL PRODUCTS	1 YEAR	YES	YES	YES	YES	NO	1, 2, 5, 6 A, B, C, D, E
REPLACEMENT PARTS	90 DAYS	YES	YES	YES	YES	NO	1, 2, 4, 5, 6 A, B, C, D
IN-MOTION VEHICLE SCALES	1 YEAR	YES	YES	YES	YES	90 DAYS	1, 2, 5, 6 A, B, C, D
SOFTWARE	90 DAYS	YES	N/A	N/A	N/A	NO	1, 6 B, C, D



Ph. (800) 441-4237
 E-mail: cardinal@cardet.com
 203 E. Daugherty
 Webb City, MO 64870

06/13
 Printed in USA
 315-WARRANTY-CAR-K

APPLICABLE LIMITATIONS AND REQUIREMENTS

1. This warranty applies only to the original purchaser. The warranty does not apply to equipment that has been tampered with, defaced, damaged, or had repairs or modifications not authorized by Cardinal or has had the serial number altered, defaced or removed.
2. This warranty is not applicable to equipment that has not been grounded in accordance with Cardinal's recommendations.
3. This equipment must be installed and continuously maintained by an authorized Cardinal dealer.
4. Applies only to components constructed from stainless steel.
5. This warranty does not apply to equipment damaged in transit. Claims for such damage must be made with the responsible freight carrier in accordance with freight carrier regulations.
6. Warranty term begins with date of shipment from Cardinal.
7. Only if device is rated NEMA 4 or better or IP equivalent.
8. Lifetime warranty applies to damages resulting from water, lightning, and voltage transients and applies only to the hydraulic load cell structure itself (does not include pressure transducers, rubber seals, o-rings, and associated wiring).
9. 10 Year prorated warranty on hydraulic load cells.
10. 1 Year warranty for scale structure.
11. PSC models' warranty coverage applies only to agricultural installations on farms up to 3,000 acres (LSC models not limited in this manner).
12. Load cell kits MUST be installed in accordance with Cardinal Scale instructions. Failure to follow these instructions will void the warranty.

EXCLUSIONS

- A.) This warranty does not include replacement of consumable or expendable parts. The warranty does not apply to any item that has been damaged due to unusual wear, abuse, improper line voltage, overloading, theft, fire, water, prolonged storage or exposure while in purchaser's possession or acts of God unless otherwise stated herein.
- B.) This warranty does not apply to peripheral equipment not manufactured by Cardinal. This equipment will normally be covered by the equipment manufacturer's warranty.
- C.) This warranty sets forth the extent of our liability for breach of any warranty or deficiency in connection with the sale or use of our product. Cardinal will not be liable for consequential damages of any nature, including but not limited to loss of profit, delays or expenses, whether based on tort or contract. Cardinal reserves the right to incorporate improvements in material and design without notice and is not obligated to incorporate said improvements in equipment previously manufactured.
- D.) This warranty is in lieu of all other warranties expressed or implied including any warranty that extends beyond the description of the product including any warranty of merchantability or fitness for a particular purpose. This warranty covers only those Cardinal products installed in the forty-eight contiguous United States and Canada.
- E.) This warranty does not cover paint coatings due to the variety of environmental conditions.
- F.) Do not cut load cell cables on load cells returned for credit or warranty replacement. Cutting the cable will void the warranty.
- G.) Software is warranted only for performance of the functions listed in the software manual and/or the Cardinal proposal.
- H.) The software warranty does not cover hardware. Warranties on hardware are provided from the hardware vendor only.
- I.) The software warranty does not cover interfacing issues to non-Cardinal supplied hardware.
- J.) The software warranty does not include automatic software upgrades unless purchased separately.



Ph. (800) 441-4237
E-mail: cardinal@cardet.com
203 E. Daugherty
Webb City, MO 64870

06/13
Printed in USA
315-WARRANTY-CAR-K



Printed in USA

8400-M117-O1 Rev D 11/15

Cardinal Scale Mfg. Co.

203 E. Daugherty, Webb City, MO 64870 USA

Ph: 417-673-4631 or 800-441-4237

Fax: 417-673-2153

www.cardinalscales.com

Technical Support: 866-254-8261

E-mail: techsupport@cardet.com