



**Pennsylvania Scale Company**

**Model 7000 Base**

**UNPACKING AND SET UP  
INSTRUCTIONS**

Pennsylvania Scale Company  
1042 New Holland Avenue  
Lancaster PA 17601

*For online interactive tech support or more information on Pennsylvania Scale products, visit our website at [www.pascale.com](http://www.pascale.com)*

Revised September 4, 2002

## Unpacking Instructions

After opening the shipping carton, remove the molded foam top from the carton. Remove the 7000 platform and place onto a flat, level and steady surface. The 2 LB and 5 LB capacity 7000 are shipped with inserts to protect them from shock loading during shipment. These inserts must be removed before attempting to operate the platform.

To remove the inserts, begin by removing the top platform cover. The inserts are corrugated cardboard blocks, placed between the platform spider and base assembly of the 7000. Simply slide these blocks out and replace the platform cover.

## Leveling the 7000

For best weighing results the 7000 should be properly leveled before operating. To level the 7000:

- Remove the top platform cover to expose the level bubble located on the platform spider of the 7000.
- Using the level bubble as a guide, adjust the four feet until the bubble is centered in the level.
- When the 7000 is level, firmly tighten the hex jam nuts on the feet.
- Replace the platform cover.
- Any time the 7000 is relocated, it should be re-leveled.

## Load Cell Wiring

The 7000 comes with a round, CPC style connector that mates with all Pennsylvania Scale digital indicators. The color codes, functions and pin assignments are as follows:

<b>WIRE COLOR</b>	<b>CPC PIN NUMBER</b>	<b>DESCRIPTION</b>
RED	1	+SIGNAL
WHITE	2	-SIGNAL
SHIELD	3	GROUND
NOT USED – KEY	4	NOT USED - KEY
BROWN/YELLOW	5	-SENSE
BLACK	6	-EXCITATION
BLUE	7	+SENSE
GREEN	8	+EXCITATION

## Calibration Instructions

Please refer to the calibration instructions for the digital indicator that will be used with the 7000 base.

# PENNSYLVANIA



## 7000 SERIES



### Indicators

### Counting Scales

### Postal Scales

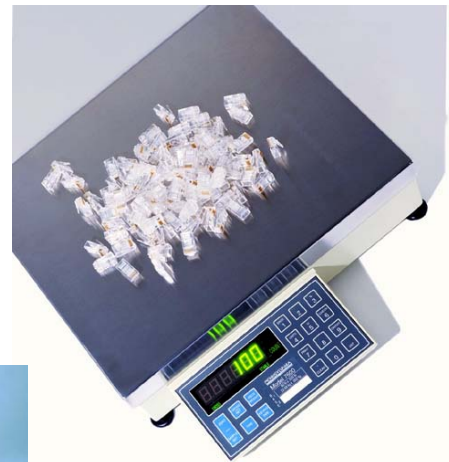

Pennsylvania Scale Company  
1042 New Holland Avenue  
Lancaster PA 17601  
V2.82

## **TABLE OF CONTENTS**

<b>SPECIFICATIONS</b>	<b>2</b>
<b>UNPACKING AND STARTUP</b>	<b>3</b>
<b>OPERATIONAL FEATURES</b>	<b>5</b>
<b>MENU ACCESS</b>	<b>7</b>
<b>OPTION CONFIGURATION</b>	<b>9</b>
<b>MENU NAVIGATION</b>	<b>15</b>
<b>7600 MENU ENTRY</b>	<b>15</b>
<b>7300 AND 7500 MENU ENTRY</b>	<b>16</b>
<b>CAL 40, FILTER &amp; CALIBRATION</b>	<b>17</b>
<b>CFG 50 COUNTING FUNCTIONS</b>	<b>18</b>
<b>CFG 60 RS232 CONFIGURATION</b>	<b>19</b>
<b>CAL 70 TIME AND DATE</b>	<b>19</b>
<b>CAL 80 FORMATED PRINT SLOT</b>	<b>20</b>
<b>CONTINUOUS OUTPUT PRINT CODES</b>	<b>21</b>
<b>COMMAND FORMATS</b>	<b>22</b>
<b>RS232 PIN ASSIGNMENTS</b>	<b>25</b>
<b>AVERAGE PIECE WEIGHT STORAGE</b>	<b>26</b>
<b>WEIGHING WITH/WITHOUT TARE</b>	<b>27</b>
<b>COUNTING</b>	<b>28</b>
<b>DISPLAY MESSAGES</b>	<b>34</b>
<b>STATUS CHARACTERS</b>	<b>35</b>
<b>115 TO 220 VAC CONVERSION</b>	<b>36</b>

# SPECIFICATIONS

## LOAD CELL A/D CONVERTER

TYPE: 24 bit delta sigma  
EXCITATION: 5 VDC, 120 mA max .  
SIGNAL INPUT: 16 mv  
SENSITIVITY: 0.1 uV/grad  
UPDATE RATE: 30 update/second

**DISPLAY:** Six (6) Decades, 0.6 inch LED

**INDICATORS:** Gross, Tare, Net, Zero, Stable, Base, Units, Count .

**POWER INPUT:** 117/217 VAC, 50-60 HZ, 20 watts, fuse 0.25 A Slo-Blow.

**SERIAL PORT:** RS232C

**INSTRUMENT:** Stainless Steel, NEMA 4x, Tilt - Stand Base, 7lbs. 10"(w) x 6.5"(h) x 4"(d)

**COUNTING SCALE:** Cast Aluminum, 14" (L) x 15.5" (W) x 5.25 (H); 15.25 lbs.

## OPTIONS:

**TIME & DATE:** 12/24 hr, battery backed.

**AC/DC:** Battery backed (counting Scale).

**REMOTE DISPLAY:** Wall or post mount.

**DUAL CHANNEL:** Independent A/D converter.

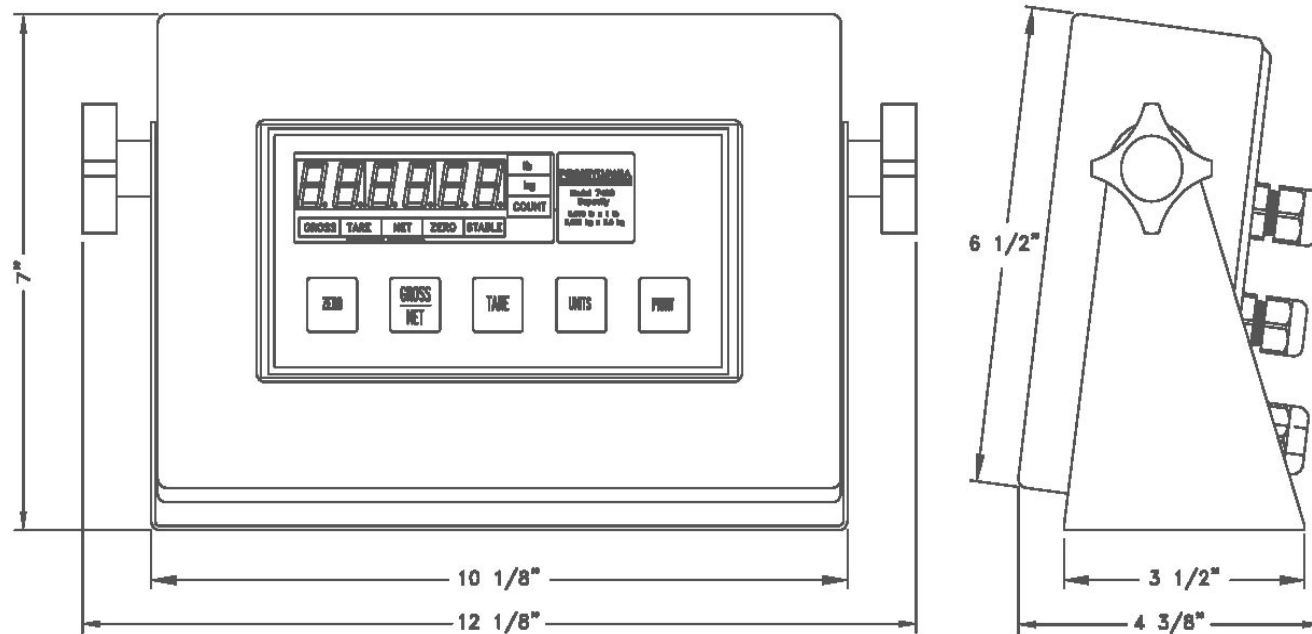

# Unpacking and Startup

## Counting Scales:

After opening the shipping carton, remove the molded foam top from the carton. (On 2 lb. and 5 lb. capacity scales the platform is packaged on top of this foam, remove it first and lay it aside.)

Gently lift and remove the stainless steel platform cover only.

Remove any options which may be packed with the scale.

Carefully remove scale from the packaging by grasping both sides of the base.  
**DO NOT LIFT SCALE BY THE TOP SPIDER OR SUB-PLATFORM ASSEMBLY.**

Place the scale on a stable, level surface for operation.

Adjust the corner leveling feet until the level bubble indicates the unit is level. Firmly tighten hex jam nuts on the leveling feet. (Any time the scale is relocated, it should be leveled.)

Remove the protective plastic wrap from the platform and place the platform on the spider.

To activate the scale, plug the line cord into any grounded 50/60 hertz 120 volt outlet.

## Plus Indicators:

Weighing platforms are shipped with the proper mating connector and need only to be plugged into the round CPC style connector on the back of the indicator.

CONNECTOR PIN #	FUNCTION	CABLE
1	+ Signal	Green
2	- Signal	White
3	Ground	Shield
4	Key	
5	- Sense	Black
6	- Excitation	Blue
7	+ Sense	Red
8	+ Excitation	Brown

# Unpacking and Startup

## Plus Indicators: Wash-down applications

Open the enclosure by removing the screws holding on the back plate. Carefully remove the back plate from the indicator. Remove the CPC connector and replace with the watertight Heyco bushing supplied and feed the load cell cable up to the terminal block. Remove sense jumpers P11-8/7, P11-6/5 for six wire.

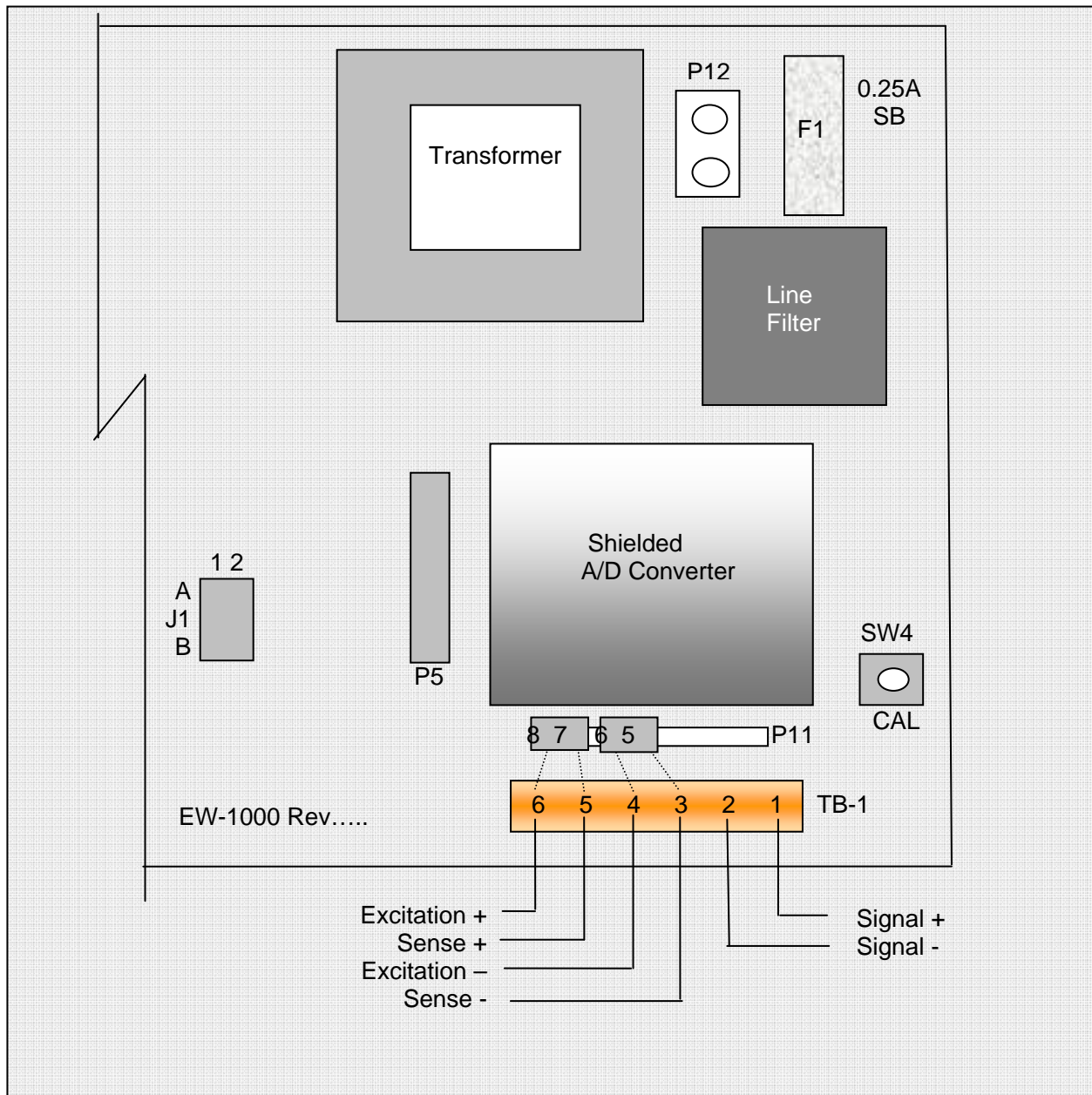



## Operational Features

**Automatic Zero-Tracking (AZT)** - Maintains the system zero and is normally set to +/- 1/4 of the display resolution.

**Count/Weigh** - Scale is capable of both counting and weighing functions. The count may be turned off on the 7600 if not needed.

**Four Selectable Sample Sizes** - Four different sample sizes may be entered into the scale memory during programming.

**Counting Functions** - A variety of different counting methods may be employed, depending on type of counting selected during calibration.

**Sample Update** - Piece weight accuracy may be improved after the initial sample by adding a quantity of parts between 10% and 100% of the original sample to the platform. When this is done the scale will recalculate the piece weight, display the new percent error/accuracy for 2 seconds and then return to the counting mode.

**Second Base** - An optional second base is available to expand the capacity of the scale.

**Peak/Hold** – Captures the peak reading directly (based on filter settings) or after preset number of “stable” readings.

**Accumulation** – Based on count or weight.

### Counting Scale Connectors:

The following connectors may be accessed through the opening on the bottom of the scale.

**D-Subminiature Connector (9-pin)** - Used with RS-232 Interface.

**Remote Display Connector** - Used to connect a remote display option to the scale.

**REMOTE BASE CPC Style connector (8 pin)** - Same as indicator wiring.

# Operational Features

## Push-Button Functions

### 7300 3-Key: Basic

**ZERO Button** - Sets the scale to zero.

**UNITS Button** - Used to switch the scale between the primary weighing unit, secondary weighing unit, and the count mode.

**PRINT Button** - Transmits formatted print to any device connected to the RS-232 port. Holding this push-button for four seconds will access the RS-232 configuration mode.

### 7500 4-Key: Basic + Sample

**SAMPLE SET Button** - Places the scale in the sample set mode for counting operations. Hold to access setpoint targets when enabled.

### 7600 18-Key: Full Numeric + Enhanced Operation

**GROSS/NET Button** - Switches the scale display between Gross weight and Net weight.

**PIECE WEIGHT Button** - Will cause the scale to display the presently stored piece weight, if any, and puts it into the piece weight entry mode.

**TARE Button** - Will tare off any weight setting on the platform and enter it into the tare memory.

**KEYPAD TARE Button** - Will display whatever tare is presently stored in the tare memory and puts the scale into the keypad tare entry mode.

**BASE Button** - Used to switch the scale between base 1 and base 2, when the second base option is installed.

**% Button** - Used to display the percent of error, or percent of accuracy. (Only if these features have been selected during programming.)

**ID Button** - Will display whatever ID number is presently stored in the ID memory and puts the scale into the ID entry mode.

**CHECK Button** - Pressing this button will cause the scale to initiate the diagnostic countdown. It may also be used as a continue key if the scale should freeze on any of the diagnostic numbers during countdown.

**CLEAR Button** - Used when the scale is in one of the data entry modes. Pressing this button once will put a decimal point onto the display and pressing it a second time will clear the display.

**ENT Button** - Used when the scale is in one of the data entry modes. Button is used to enter information into the system memory.

## Menu Access: Configuration and Calibration

To access instrument configuration, calibration or to enable options, depress the “Zero” key for five seconds.

The Audit Trail counters (“Pxxxx” and “Cxxxx”) are displayed first followed by access code request (“AC?”). The initial factory setting is “0000” which is entered “AC0000” and “Print”. If no entry is made, instrument returns to operate mode. Stepping the “Zero” key when “AC?” is on, will display software version, display check and keypad test.

### Key Functions

#### The 7300 3-Key access functions (-----)



#### The 7500 4-Key access functions (-----)



**DP/Clear:** Enters a decimal point or double push clears the display.

**Increment:** Scrolls selection of sub parameters or increments value for numeric entry.

**Advance:** Multiplies a numeric entry by “10”.

**Enter:** Stores entry and steps to the next parameter or exit.

#### The 7600 (18-Key) uses direct key entry.

The access code can be changed to any four digit combination when exiting setup and display is “AC ?”, either input change and enter or use enter alone to exit.

**Front panel access is inhibited if conventional “sealing” is applied by setting jumper J1-1 in the B position. The internal “CAL” button is then used for access.**

Holding the “CAL”, will display the current “7X00” and subsequent stepping of the button will select 7300, 7400, 7500, 7600, etc. Leave on current model and allow time out to incorporate.

## Menu Layout:

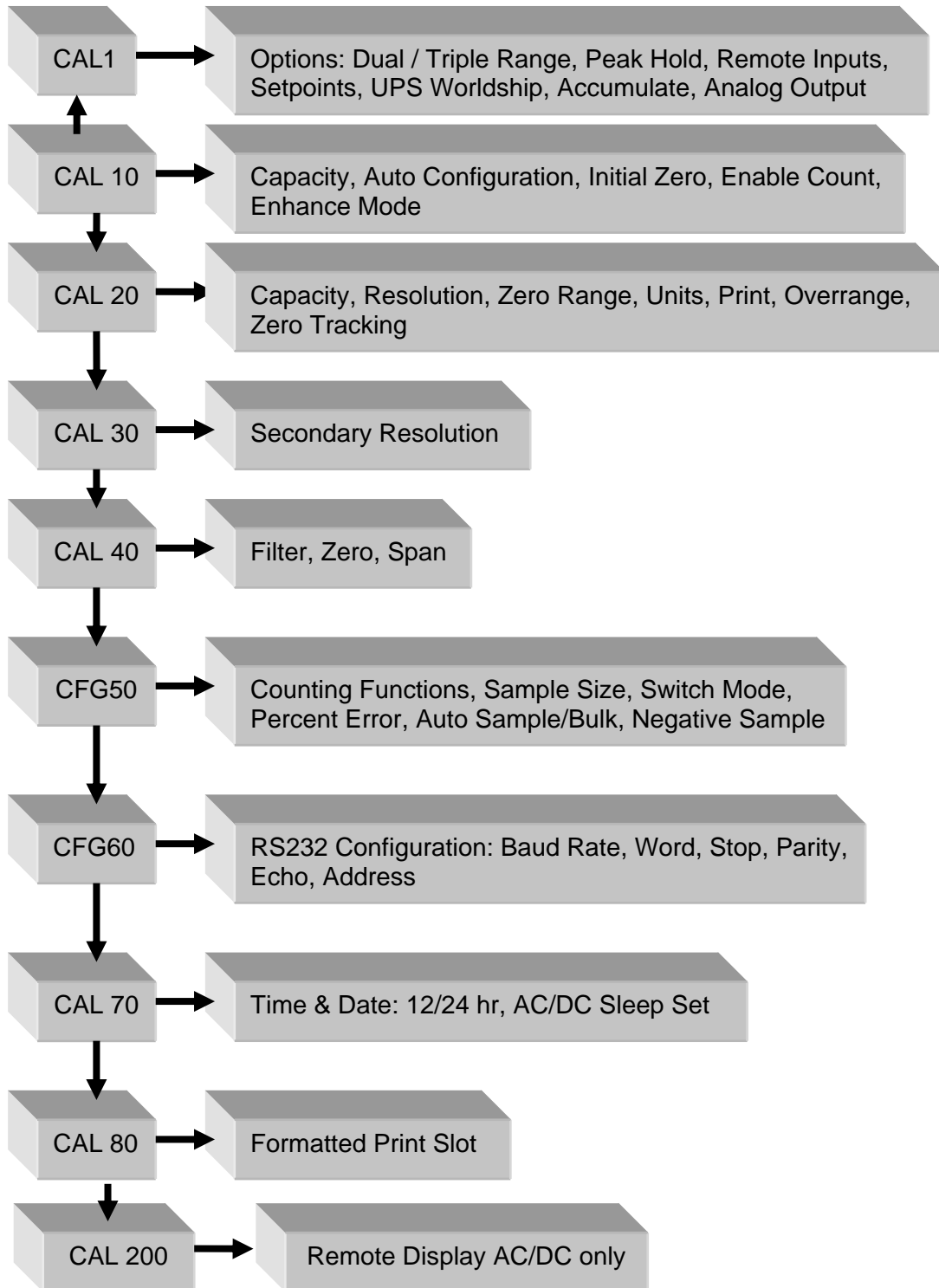

### Option Configuration (Cal 1):

Step	Parameter	Definition
bat 1	OFF, On	Charger enabled/disabled (AC/DC board only)
dtr 2	0.....15	Dual/Triple Range (0 = off)
Pnt 2.1	0.....99%	Sets low range of dtr
Pnt 2.2	0.....99%	Sets mid range of dtr, if 11-15 selected.

dtr	High Res.		Medium Res.	
0	----	---	----	----
1	50%	X2	----	----
2	50%	X5	----	----
3	25%	X2	----	----
4	25%	X5	----	----
5	20%	X2	----	----
6	20%	X5	----	----
7	20%	X10	----	----
8	10%	X2	----	----
9	10%	X5	----	----
10	10%	X10	----	----
11	25%	X5	50%	X2
12	10%	X5	50%	X2
13	25%	X10	50%	X2
14	10%	X10	50%	X2
15	1%	X100	10%	X10

Step	Parameter	Definition
PHd 3	OFF, Peak-H, Hold	Peak/Hold function, zero key clears current peak, tare function is disabled, print code 22 and 32 are modified to value and value with labels (xx.xxx / Peak xx.xxx lb)
HdS 3.1	0.....240	Hold after "samples": Weight must be stable for 0 – 240 samples to "hold".

<b>RIn 4</b>	<b>no, yes</b>	Remote inputs,(with DIO option) <b>Input 1:</b> Gross/net, <b>Input 2:</b> Tare, <b>Input 3:</b> Zero, <b>Input 4:</b> Print
<b>5</b>	<b>Nor, UPS,FEEd 12, FEEd 96, PUrOL, Toledo</b>	<b>UPS WorldShip</b> , Parameters 25, 60-69, 80 + are hidden, format:9600/odd/7/2,“39” outputs the UPS format. Federal Express: 1200,8,none,1 Federal Express: 9600,7,even,1 Purolator: 1200,8,none,1 Toledo: Mode only, set serial with 60-69
<b>ACC 6</b>	<b>OFF, A-Cnt, Cnt, A-Pri, Pri</b>	<b>A-Cnt:</b> Auto count accumulator <b>Cnt:</b> Manual count accumulator <b>A-Pri:</b> Auto primary units accumulator <b>Pri:</b> Manual primary units accumulator

<b>AOS 7</b>	<b>Gross, Net, Display</b>	Sets the weight that the output represents: Gross, Net, or Display.
<b>Zr 7.1</b>	<b>0.00</b>	Sets the value of weight that is equal to 4mA/0V.
<b>FS 7.2</b>	<b>Full-scale</b>	Sets the value of weight that is equal to 20mA/10V.
<b>Zr.A 7.3</b>	<b>Zero Cal Adjust</b>	Use the cal up/down keys (table II) to set the output to as close to 4mA/0V that is acceptable to one’s requirements.
<b>SP.A 7.4</b>	<b>Span Cal Adjust</b>	Use the cal up/down keys (table II) to set the output to as close to 20mA/10V that is acceptable to one’s requirements.

<b>INSTRUMENT</b>	<b>CAL UP</b>	<b>CAL DOWN</b>
7300	ZERO	UNITS
7500	SAMPLE	UNITS
7600	UNITS/4	PRINT/7

<b>SPT 8</b>	<b>OFF, Tr, Prtr, drtr, drtk, C tr, C Prtr, C drtr, C drtk, C rang</b>	<b>tr : Target weight relay K1 Prtr : tr + Preact weight Drtr : tr + Dribble weight relay K2 Drtk : tr + dr + Trickle weight relay K3 C tr : Target count relay K1 C Prtr : tr + Preact count C drtr : tr + Dribble count relay K2 C drtk : tr + dr + Trickle count relay K3 C rang : Tr + window (0,1,10) see below.</b>
<b>Out 8.1</b>	<b>CHG, dIO</b>	<b>CHG : Uses battery ckt to drive LED dIO : Uses relay board, K1-3.</b>
	<b>dIO</b>	<b>Relays as per SPT 8</b>
	<b>CHG</b>	<b>tr : LED on &lt; tr, off &gt; tr Prtr : on &lt; Pr, flashes &lt;tr, off &gt; tr Drtr : on &lt; dr, flashes &lt;tr, off &gt; tr Drtk : on &lt; dr, flashes fast &lt; tk, slow &lt; tr</b>

**Example: Target set point is 1000.**

<b>C Range</b>	<b>OFF (Battery out/K1)</b>	<b>ON (Battery out/K1)</b>	<b>OFF (Battery out/K1)</b>
0	0 to 999	1000	1001 to capacity
1	0 to 998	999 to 1001	1002 to capacity
10	0 to 989	990 to 1010	1011 to aapacity

# Option Configuration Dual Channel:

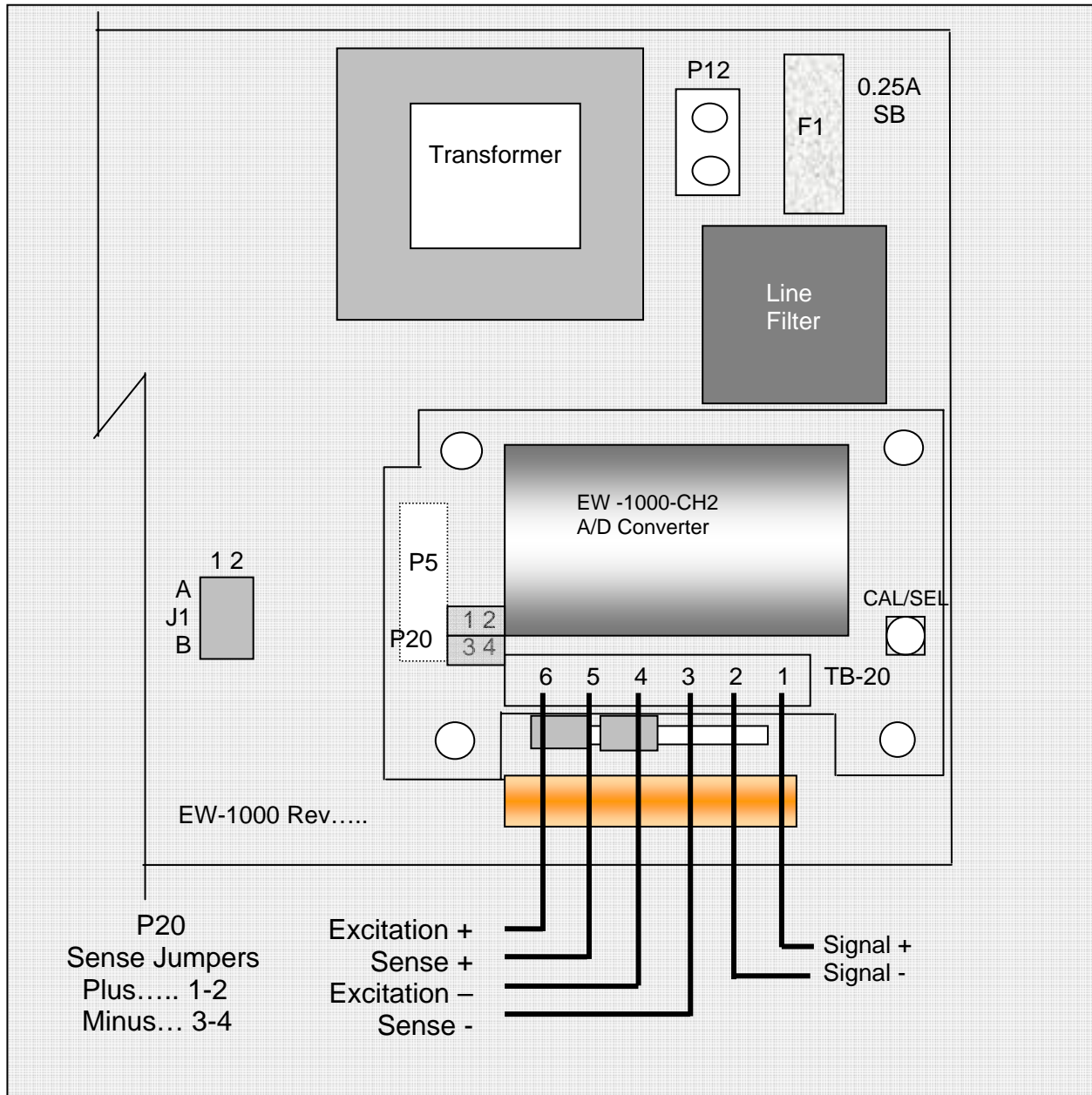



### Option Configuration DIO:

AC Inputs; D1, D2 are not installed, J1 = short (underside), J2 = open, R1 – R4 = 18k (3w, 5%, flame proof).

DC Inputs; D1, D2 are installed, J1 = open (cut trace), J2 = short, R1 – R4 = 1.5k (1/2w, 5%, carbon film).

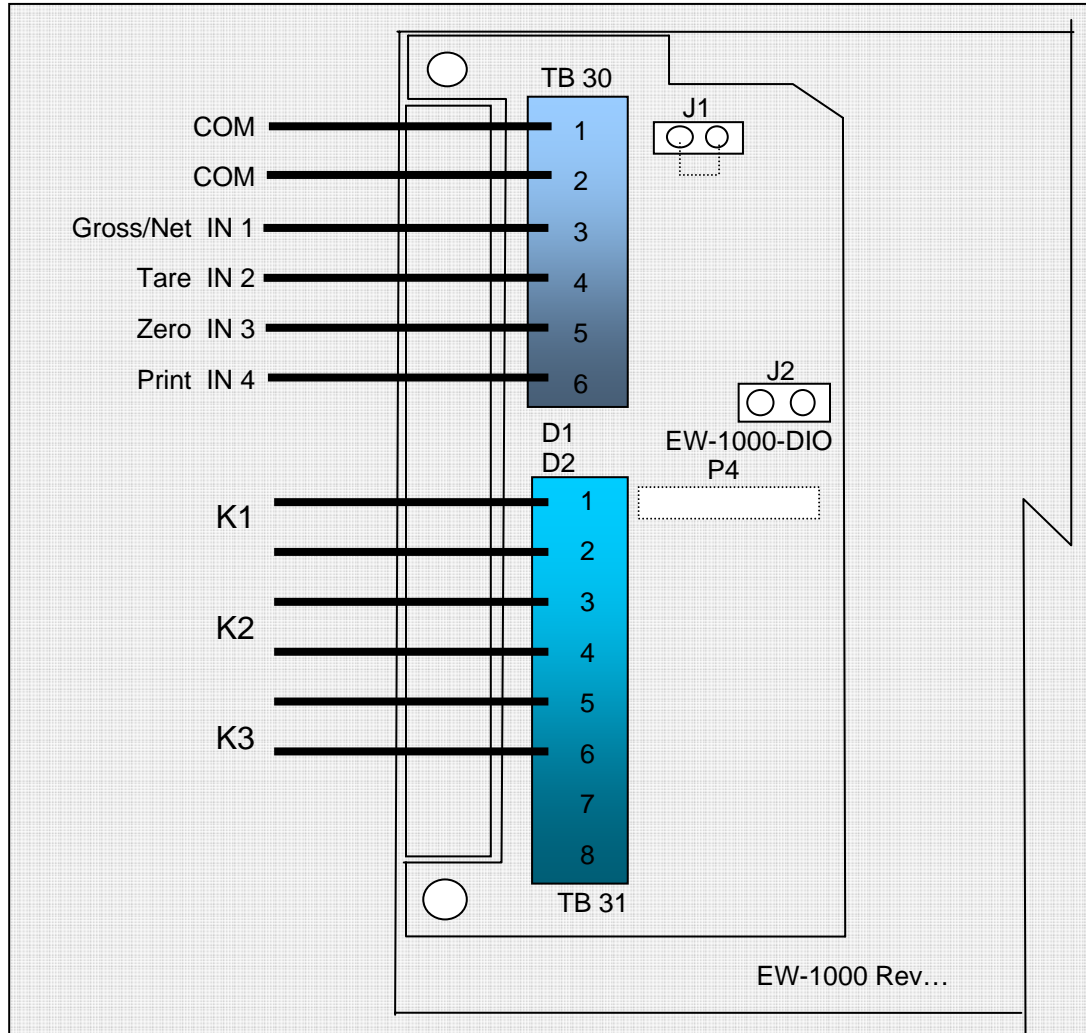

# Option Configuration Analog Output:

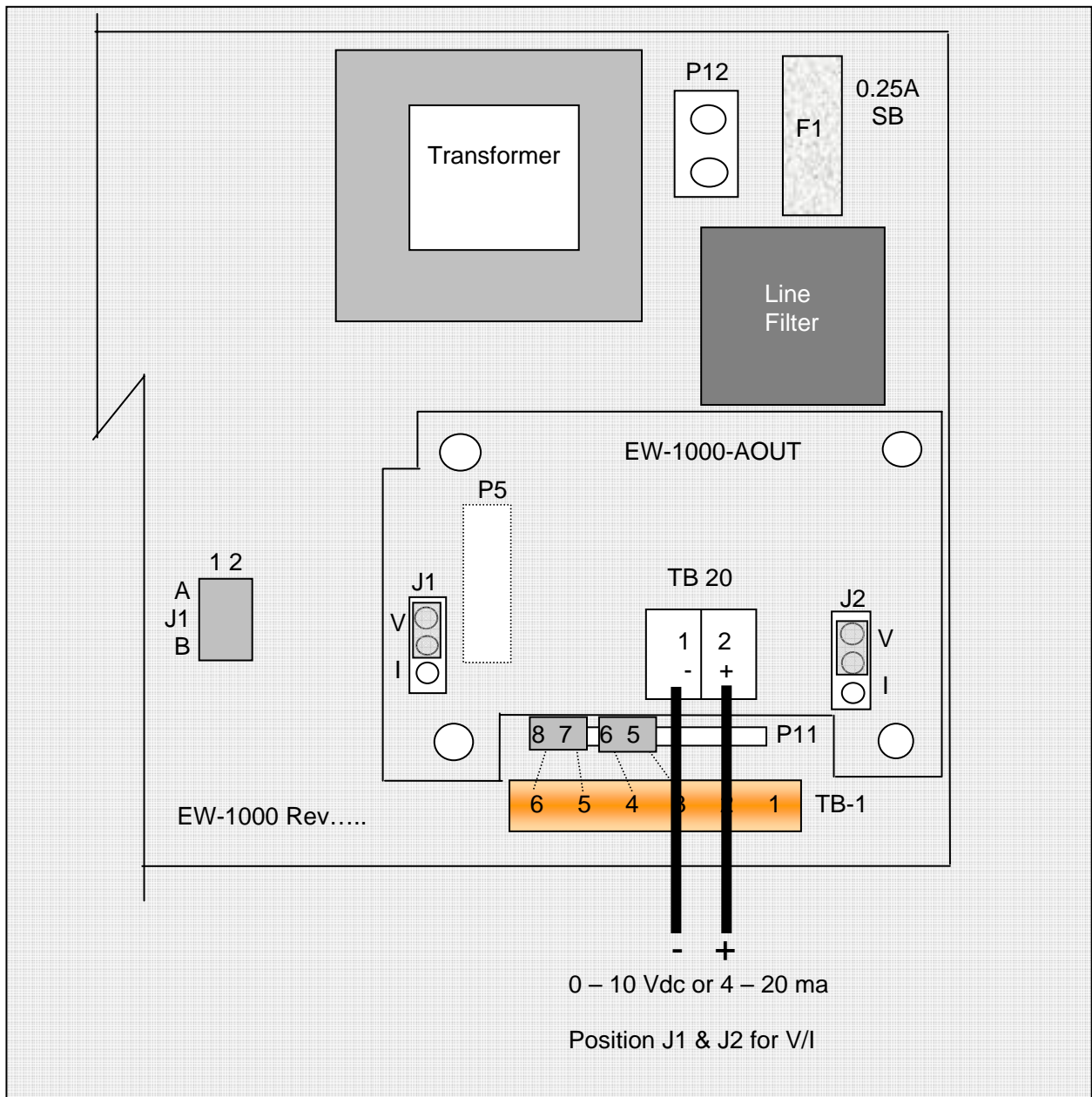

## Menu Navigation

**Configuration Blocks: 50, 60, 70 and 80** may be accessed from the front panel of the scale by pressing and holding the PRINT button for 2 seconds. The scale will then display CFG 60. At this point, you can press ENT to select this category or key in the number of any of the other accessible categories.

**Configuration/Calibration Main Blocks: 10, 20, 30, etc** can be stepped to directly by incrementing "CAL 10" to "20" and "enter" (Options are CAL 1). The sub parameters need to step through to the next "main" before a direct change.

From any "main" point, exit by changing to "CAL 0" and "enter". A "store" "no" will need to be changed to "yes" to save any changes. Changing to "CAL 0" from within "CAL 40" allows exit prior to adjusting span.

**NOTE:** During the setup procedure each step will be printed to any device interfaced to the RS-232 port. If options are not present, steps will not appear.

### 7600 Menu entry point:

Step	Parameter	Definition
bAS ?	1, 2	Select 1(main) or 2(remote base) and ENT. Only when dual channel installed.
CAL 10		Capacity, auto-config, Initial zero, count (Press ENT or inc/ENT to step).
CAP 11	Full Capacity	Key in the capacity of the base.
ACL 12	Yes, No	Auto configuration. Use the UNITS button to select YES or NO. If YES the scale will jump to Cnt 14, EnH, Prt 25 and CAL 40 storing defaults "*". If NO is selected the scale will proceed to the next step.
A-0 13	Yes, No	Select if scale is to auto zero when first turned on. Use the UNITS button to select YES or NO*.
Cnt 14	Yes, No	Turn count mode on or off. Use the UNITS button to select YES* or NO.
EnH 15	Yes, No	Turn on for count "enhance" mode. (skipped if count is off)
Str 16	OFF, A	Enables average piece weight storage.

Step	Parameter	Definition
<b>CAL 20</b>		Capacity, resolution, zero, units, print, zero track .
<b>CAP 21</b>	<b>Full capacity</b>	By-passed when entered in CAL 10.
<b>rES 22</b>	<b>1, 2, 5</b>	Resolution - Input Scale Resolution. Default (*) entry is the capacity of the scale divided by 5000 and rounded to the nearest 1, 2, 5.
<b>-0- 23</b>	<b>1.9, 10, 30</b>	Zero Range - Input the Zero Range in % of full scale. The amount of weight the scale is allowed to Zero.
<b>UnS 24</b>	<b>1, 2, 3, 4, .....14</b>	Select the primary weighing unit by keying in a number :1 = lb*, 2 = kg, 3 = g, 4 = oz t, 5 = lb t, 6 = g, 7 = dwt, 8 = oz, 9 = c, 10 = oz f, 12 = l, 11 = ml, 13 = tons, 14 = lb - oz
<b>Prt 25</b>	<b>Stable, First, Unstbl, ntEP Auto, Prn-1</b>	Print: Select whether the scale will respond to a print request when stable, first (positive) stable, any time (unstable), or NTEP. Auto: prints when stable and min 10 grads above zero, prints again with min 25 grad change from last print. Does not need to return to zero. Prn-1: Single stable print, must return to zero
<b>Cnd 26</b>	<b>Yes, No</b>	Overrange: Select YES (9d) or NO (105%)*.
<b>0-t 27</b>	<b>0.00</b>	Zero tracking value entered as a percent of display resolution. Entering a 0.25* equals 25% of one display graduation. "0" disables the zero tracking feature.
<b>SbL 28</b>	<b>OFF, 1, 3, 5, 10</b>	Select motion in grads/sec.

<b>CAL 30</b>		Secondary units, resolution.
<b>2Un 31</b>	<b>1, 2, 3, 4, .....14..15(user)</b>	Select secondary weighing unit by keying in a number: 1 = lb*, 2 = kg, 3 = g, 4 = oz t, 5 = lbt, 6 = g, 7 = dwt, 8 = oz, 9 = c, 10 = oz f, 12 = l, 11 = ml, 13 = tons, 14 = lb – oz, 15 = user
<b>2rE 32</b>	<b>1, 2, 5, (plus user)</b>	Secondary weighing resolution. Key in the resolution for the secondary weighing unit.
<b>CnU 33</b>	<b>0.000001 to 999999</b>	Conversion Factor ( 31 must be set on 15)

<b>EPn 34</b>	<b>n = -4 to 4, (10^n)</b>	Multiplier exponent (0.0001 to 10000)
<b>PUD 39</b>	<b>PrI, SEC, SEC On, COUnt, SELECt</b>	Power up: Primary units, Secondary units, Secondary units and Count, Count, With RTC Gross/Net restored.

<b>Step</b>	<b>Parameter</b>	<b>Definition</b>
<b>CAL 40</b>		Filter, zero/span calibration.
<b>FIL 41</b>	<b>0, 1, 2, 3, ....9, 11...15</b>	Response time: 0-9 selects conversions to average directly. 11-15 correspond to 25, 30, 35, 40, & 50 conversions for extended filtering.
<b>ADJ.CAP</b>	<b>No,Yes, (11 Pnt 7600only)</b>	7300,7500 select yes to enter normal calibration.11 Pnt, 7600 provides multi-point linearity and bypasses 42-45.
<b>noI 42</b>	<b>0.00</b>	No Load - With the platform in place but no weight on the scale, press ENT. Display will indicate "-----" and step if reading is acceptable.
<b>HLF43</b>	<b>XXX.XX</b>	Half Capacity - Apply a half capacity weight to the platform and press ENT.1/2-capacity weight is unavailable, place a substitute weight on the platform and key in the amount of weight being used and press ENT. Display will indicate "-----" and step if reading is acceptable.
<b>FUL44</b>	<b>XXX.XX</b>	Full Capacity - Apply a full capacity weight to the platform and press ENT. If a full-capacity weight is unavailable, place a substitute weight on the platform, key in the amount of weight being used and press ENT. Note: Weight used in 43 can be keyed in again.
<b>noI 45</b>		No Load - Remove all weight from the platform and enter, or just use ENT to skip this step.

**Entering a "0" during this sub-menu will jump to the beginning "CAL 40" to allow bypassing span changes. A second "0" will exit setup and question "SAVE" to effect changes or abort.**

**11 Point CALIBRATION:**

<b>KEY (FUNCTION)</b>	<b>DISPLAY</b>	<b>Definition</b>
(Live weight 123 lb)	"C"__123	11 Point Cal mode scale reading
Zero (acquire dead load)	"-----" to "C__0.0"	acquires new dead load
(live weight 5000 lb)	"C"__4995	Scale reading with load

**Enter numeric value directly:**

Key in 50000                      005000                      adjusted value

**Then ENT:**                      "-----" to "C" 5000                      displays new span

Repeat with increasing loads as required then ENT to exit CAL, a new zero is required to clear linearity points, but if a zero is taken without a new span point, then the prior spans remain. Entering a "0" during this sub-menu will jump to the beginning "CAL 40" to allow bypassing span changes. A second "0" will exit setup and question "SAVE" to effect changes or abort.

<b>Step</b>	<b>Parameter</b>	<b>Definition</b>
<b>CFG 50</b>	<b>(7500, 7600 only)</b>	<b>Counting functions. (Cnt 14=yes)</b>
<b>SS1 51</b>	<b>10</b>	Key in first sample size. (Normal entry is 10). Set to "0" to turn off count mode.
<b>SS2 52</b>	<b>20</b>	Key in sample size two. (normal entry is 20)
<b>SS3 53</b>	<b>50</b>	Key in sample size three (normal entry is 50)
<b>SS4 54</b>	<b>100</b>	Key in sample size four (normal entry is 100)
<b>PCt 55</b>	<b>Yes, No (7600 only)</b>	Select if piece weight is to be displayed as weight per 1000.
<b>Enh 55</b>	<b>Yes, No (7500 only)</b>	Turn on for count "enhance" mode. (skipped if count is off)
<b>2S 56</b>	<b>Yes, No (7600 only)</b>	Enable Two Switch counting method.
<b>Pr 57</b>	<b>P Err, P Acc, disable (7600 only)</b>	Percent of error, percent accuracy, disable the percent error feature.

<b>ASb 58</b>	<b>Yes, No (7600 only)</b>	Select automatic sample-to-bulk. (dual channel required)
<b>nEG 59</b>	<b>Yes, No</b>	Select if negative sampling will be allowed during two switch, top end counting.

<b>CFG 60</b>		RS-232 Configuration (This step can also be reached from the front panel by pressing and holding the PRINT button for 2 sec.)
<b>bAU 61</b>	<b>300,600,1200,2400, 4800, 9600*, 19200, 38400</b>	BAUD RATE: Select a baud rate using the UNITS button.
<b>LEn 62</b>	<b>7, 8</b>	WORD LENGTH: Select: 7 bits*, 8 bits.
<b>SPb 63</b>	<b>1, 2</b>	STOP BITS: Select: 1 stop bit*, 2 stop bits.
<b>PAr 64</b>	<b>None, Odd, Even</b>	PARITY: Select: None, Even, Odd*.
<b>Ech 65</b>	<b>No Ech, Ech</b>	Select: No Echo*, Echo.
<b>Cdr 66</b>	<b>0...255</b>	ADDRESS: Key in a number from 0* to 255, 0 disables this feature.

<b>Step</b>	<b>Parameter</b>	<b>Definition</b>
<b>CAL 70</b>	<b>7600 std, 7500 option</b>	Setting of time and date.
<b>StF 71</b>	<b>0, 1, 2, 3</b>	Select type of clock: 0 = Time and date OK, skip to SLP 74, 1 = 24 hour clock, 2 = 12 hour clock, currently AM, 3 = 12 hour clock, currently PM.
<b>td1 72</b>	<b>HH MM SS</b>	Enter the current time as HHMMSS. Based on the type of clock selected in step 71. Clock will begin with the pressing of the ENT button.
<b>td2 73</b>	<b>MM DD YY</b>	Enter the current date as MMDDYY.
<b>SLP 74</b>	<b>0...12</b>	For AC/DC versions of the scale, enter the amount of time the display is to remain on before going into the battery saver sleep mode. The time is entered in number of minutes, from .5 to 12. Entering a zero will disable the sleep mode for AC only scales.

## CAL 80 Formatted print slot programming

### BUILDING A FORMATTED PRINT

The user defined formatted print is the string of information sent from the RS-232 port when the PRINT button is pressed, or the scale receives an SRP command from a computer or terminal. The user selects the format of this string by entering two digit print codes into the 20 available print slots, PSL 81 through PSL 101. When you are finished entering data to construct the formatted print, "99" is entered to mark the end of print formatting.

### EXAMPLE OF BUILDING A FORMATTED PRINT

To build a simple formatted print that could be sent to a ticket printer the following print codes could be entered:

PSL 81 - 30 (gross w/ prefix & suffix.)

PSL 82 - 65 (CR/LF)

PSL 83 - 32 (net w/ prefix & suffix.)

PSL 84 - 65 (CR/LF)

PSL 85 - 31 (tare w/ prefix & suffix.)

PSL 86 - 65 (CR/LF)

PSL 87 - 99 (End)

The result:

GROSS	1.205 lb
NET	0.205 lb
TARE	1.000 lb

### FORMATTED PRINT CODES

02	Time	12	"Base" prefix	22	net weight (or Peak)	32	Net weight prefix, data, suffix, (or Peak)
03	Date	13	"ID" prefix	23	Count	33	Count pre.data & suffix
04	unit suffix label	14	FR"F1"	24	Piece Weight	34	Piece Weight prefix, data, suffix
05	"GROSS" prefix	15		25	Sample Size	35	Sample Size prefix data & suffix
06	"TARE" prefix	16	P1	26	% Error or Accuracy	36	Percent Error/Accuracy prefix, data, and suffix
07	"NET" prefix	17		27	Base in use	37	Base in Use prefix & data
08	"COUNT" prefix	18		28	ID Number	38	ID Number prefix, data
09	"PIECE WEIGHT" prefix	19	"Pcs" suffix	29		39	UPS format
10	"SAMPLE SIZE" prefix	20	gross weight	30	Gross weight prefix, data and suffix	40-49	Print strings 1 – 9
11	"err" or "acc" prefix (%=error / accuracy)	21	Tare weight	31	Tare pre.data & suffix		

Note: In lb-oz mode, 20-22 will print oz only, 30-32 will print lb-oz.



## Continuous Output Print Codes

50	Continuous output (Formatted print will be sent continuously as long as scale is turned on.)
51	Toggled continuous output (The formatted print will be sent continuously after the PRINT button is pressed or an SRP command is received by the scale. Pressing the PRINT or sending SRP a second time will turn off the continuous output.)
52	Status Character (May be used by a computer to determine the condition of the scale at any given moment.)
53	ABO Checksum (May be used in building a continuous output compatible with other Pennsylvania Scales.)
54	Select Leading Zeros

## Print Special ASCII Characters Formatted Print Codes

60	ASCII space (SP)
61	ASCII horizontal tab (HT)
62	ASCII line-feed (LF)
63	ASCII start of header (SOH)
64	ASCII carriage return (CR)
65	ASCII carriage return and line feed (CR LF)
66	ASCII form-feed (FF)
67	Turn on large print (PA Scale printer)(SO, HEX 0EH)
68	Turn off large print (PA Scale printer)(SI, HEX 0FH)
69	ASCII null (NUL)
78	Invert print (PA Scale printer)(DC3, HEX 13H)
79	End inverted print (PA Scale printer)(DC4, HEX 14H)
80	Print accumulator name, value and units
81	Print "Accum. Total"

82	Print accumulator value
83	Print Force a clear accumulator and transaction counter
84	Print Prompt clear accumulator and transaction counter
85	Print transaction name and counter
86	Print "Transaction"
87	Print transaction counter
98	"98" is a second print string triggered by the Accumulator.
99	Marks the end of the formatted print

**CAL 0 Press ENT to exit calibration.**

## COMMAND FORMATS

The Model 7600 can be controlled from an external device (such as a computer or terminal) by various commands, each three letters long, which represent related English phrases or words. For example, to tell the scale to zero, type ZRO followed by a carriage return.

The basic command formats are:

[<add>]<cmd><cr>

<cmd> [<xx.xx>]<cr>

Where <cmd> is a three-letter command, <add> is a scale address number (0-255), <cr> represents a carriage return, and <xx.xx> is a mixed number, the brackets [ ] are used to indicate an optional part of the command.

Examples:

SRP<cr>                      Send a formatted print

ITW 13.43<cr>              Instructs scale to set tare weight  
to 13.43 in the current unit

5 SGW<cr>                    Instructs the scale with address #5 to  
send the Gross weight.

## General Commands

ATW	Acquire Tare Weight
CHK	Initiate self-diagnostics CHeCK
LCK	LoCK out keypad
RES	RESet, clears tare weight and count information
SCM	Select Count Mode
SCI	Prints configuration on port one
SSS	Select Sample Size
SWM	Select Weight Mode
UCK	UnloCK keypad
UNP	UNit Primary
UNS	UNit Secondary
ZRO	ZeRO scale

## Commands Which Enter Information into the Unit

IBA	[ FLOATING POINT NUMBER ]	Input BAse number (with option)
IPW	[ FLOATING POINT NUMBER ]	Input Piece Weight
ITW	[ FLOATING POINT NUMBER ]	Input Tare Weight
IID	[Up to 15 characters, 0 - 9 & hyphen]	Input ID
IUS	[Print string, 40 – 49]	Input Print string

### Commands Which Request Information

SBA	Send BAse in use (with second base option)
SCO	Send COunt
SDT	Send DaTe
SGW	Send Gross Weight
SID	Send Part ID
SMI	Send Metrological Information
SNW	Send Net Weight
SPC	Send Print Codes
SPR	Send PeRcent error or accuracy
SPW	Send Piece Weight
SRP	Send Requested Print
SSZ	Send Sample siZe
STM	Send TiMe
STW	Send Tare Weight
SVN	Send Software Version Number

**NOTES: All commands and parameters must be separated by spaces. The entire command string must be terminated with a carriage return.**

### Custom serial string command: IUS

IUS x y, where x selects the string 1 – 10 and y is the string comprised of up to 22 characters. The strings are printed with using the format codes 40 – 49 where string 1 is 40, 2 is 41, etc.

IUS <enter>: List all strings

IUS 1<enter>: Clears string one

## RS-232 PIN ASSIGNMENTS AND IMPLEMENTED FUNCTIONS

Connection to the Serial Port is made via a DB-9 female connector found in the access area on the bottom of the scale. Instrument connection is on TB-2.

PIN	EIA CODE	FUNCTION	DIRECTION
2	BB	Transmit Data	Output
3	BA	Receive Data	Input
5	AB	Signal Ground	-

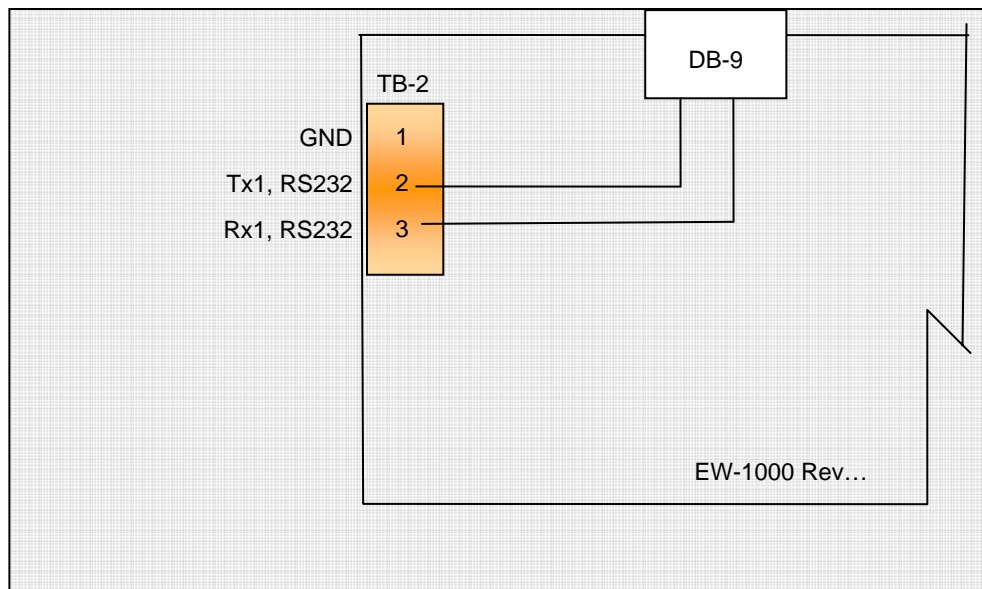

## Average Piece Weight Storage

APW ID memory in 7600 counting scale mode (This function is not available for other instrument selections).

Parameter 16, "STr 16" selects OFF or A.

The "A" selection is expanded storage of APW's. Key in an ID or, using the TARE (NEXT) or KEYPAD TARE (LAST) keys, selects a currently stored ID. If the ID exists and has APW>0, the stored APW is loaded into the PIECE WEIGHT memory and the count display is selected. If the ID is new or has an APW= 0 (initial value when the ID is first entered), the "Add xx" prompt is displayed so an APW can be established and stored to ID memory.

### Key functions during ID selection/entry:

KEY	FUNCTION
ZERO	Clear ID
GROSS/NET	Print all IDs w/ their stored APWs and integrity status (OK or ERR). See the text box to the right.
TARE	Select next ID
TARE RECALL	Select last ID
CLEAR	Press and release to clear the currently selected ID, or press and hold to access the "clear all" prompt.
ENTER	Enter if keyed in or select the displayed ID.
0-9	Key in a new or existing ID and then press the enter key to accept.

COUNTING SCALE ID MEMORY			
0	1200	0.00500	OK
1	2000	0.00338	OK
2	8080	0.00484	OK
3	6800	0.00415	OK
4	6811	0.00472	OK
5	8085	0.00326	OK
6	6812	0.00470	OK
7	100000	0.00163	OK
8	80188	0.02129	OK
9	6808	0.0003	OK
10	1000	0.00334	OK
11	8051	0.00831	OK
12	80186	0.00166	OK
13	6502	0.00117	OK
14	74244	0.00014	OK
15	74573	0.00799	OK
16	100	0.00824	OK

Note: While one is keying in an ID, one can press the blue zero key to abort the entry and view the last keyed or selected ID.

Specifications:

Storage locations: 250

ID size: 21-digit (0-9)

Data stored: ID, APW, and CRC verification number.

### **WEIGHING WITHOUT TARE**

1. If the second base option has been installed, press the BASE button to select base 1 or base 2. When base 2 is selected the base 2 LED will be lit. When base one is selected the base 2 LED will be out. If base 2 has been locked out during calibration, the word "Error" will momentarily show on the display.
2. Press the UNITS button to select either the Primary weighing unit or the secondary weighing unit. (Associated indicator will be lit.)
3. Verify that the "GROSS" indicator is lit. If not, press the GROSS/NET button to light this indicator and put the scale into the gross weight mode.
4. Establish a base zero by pressing ZERO with nothing on the scale platform to clear any existing weight readings.
5. Place the item(s) to be weighed on the platform and read the weight on the display.

**NOTE:** If very light items (less than 1/4 of the display resolution) are placed on the platform individually, the weight may be zeroed off by the AZT feature. Add light items to the platform simultaneously.

### **WEIGHING WITH TARE**

1. If the second base option has been installed, press the BASE button to select base 1 or base 2. When base 2 is selected the "base 2" LED will be lit. When base one is selected the base 2 LED will be out. If base two has been locked out during calibration, the word "Error" will momentarily show on the display.
2. Press the UNITS button to select either the Primary or the Secondary weighing unit. (Associated indicator will be lit.)
3. Press the ZERO button with nothing on the platform to establish a base zero.
4. A tare weight may be acquired using one of the following methods:
  - a. Place the container or object to be tared off on the platform and press TARE; or
  - b. Press the KEYPAD TARE button and then key in the weight of the container or object, and press ENT.
5. The net weight value will be displayed on the weight display and the NET indicator will be lit.
6. Pressing the GROSS/NET button will toggle between gross weight and net weight.
7. When a tare value is stored in the system, the TARE indicator will be illuminated.
8. Place the objects to be weighed in the container and read the net weight on the display. To clear a tare value, remove all weight from the scale and press TARE, or press KEYPAD TARE, key in 0 and press ENT.

**NOTE:** IF the tare has been acquired using the TARE button, the tare value may be viewed by pressing KEYPAD TARE. Pres ENT to return to the weight display without altering the tare weight.

## **COUNTING**

An electronic counting scale counts parts by knowing the weight of a single piece, dividing that into the total weight on the scale and displaying the result. With the 7600, this piece weight may be entered into the scale by one of two methods:

**FIRST:** Counting out a "sample" quantity of the parts and placing them onto the scale. The scale will take the weight of the sample, divide it by the known quantity and derive a piece weight used to count the rest (or "bulk") of the parts.

**SECOND:** If the individual piece weight of the parts is already known, this weight value may be entered into the scale via the keypad.

### **SAMPLE SIZE:**

If the "sample" method of piece weight entry is used, the total weight of the sample must be at least 0.04% of platform capacity or the scale will not recognize the sample. When sampling, it is always advantageous to use the largest sample possible. Not only does the larger quantity tend to average variations in the weight of individual pieces, but the heavier sample weight improves the counting accuracy of the scale itself.

## **NORMAL COUNTING PROCEDURE**

**ONE SWITCH COUNTING** - The 7600 is normally shipped from the factory set up to follow this counting procedure. Unless your 7600 has been programmed for one of the alternate counting choices, this procedure is the only one necessary to learn.

### **NORMAL COUNTING - Using Sample**

1. If a container will be used to hold items being counted, place it on the platform.
2. Press the SAMPLE SET button. The scale zeroes. "AddXXX" appears on the display (where "XXX" is one of the four pre-programmed sample sizes.). Repeated pressing of the switch successively displays the four sample sizes entered during calibration.
3. If a different sample size is required, key in the desired sample size (do not press ENT).
4. Place the entire sample on the platform at one time. (If the scale has been programmed to show the percent of error; this value will be displayed momentarily at this time.) The scale will now automatically switch to the count mode, displaying the number of parts in the sample.
5. All of the remaining parts may now be added to the scale and counted. ZERO, TARE and KEYPAD TARE buttons may now be used without affecting the piece weight.
6. To count a different part, return to step one.



### **NORMAL COUNTING - Keypad Piece Weight Entry**

If the individual weight of the parts being counted is known in advance the piece weight may be entered through the keypad. This eliminates the need for the sample set operation. (If the percent of error feature has been selected in programming, the scale will not calculate the percent of error when keypad entry of piece weight is used.)

1. Select the appropriate weighing unit (primary or secondary) for the piece weight being entered by pressing the UNITS/4 switch.
2. Press the PIECE WEIGHT switch. The display will alternately show "PC" and any previously stored piece weight.
3. Key in the weight of one piece and press ENT.
4. The scale will go into the count mode.
5. If a container will be used to hold the parts, place it onto the scale and use the ZERO and/or TARE buttons to zero the scale. Add the parts to the scale at this time.  
NOTE: The parts in a full container may also be counted by placing the full container onto the scale and using KEYPAD TARE to key in the tare weight of the container.

### **ALTERNATE COUNTING METHODS**

The 7600 may be programmed to perform a wide variety of different counting methods. the following section describes these counting methods, refer to the "Calibration and Programming Manual" for information on setting your scale to perform one of these.

#### **Two Switch Counting**

The 7600 can be programmed so that when the scale is in the sample set mode, the sample will not be accepted until the ENT button is pressed. This allows parts to be added to the platform one at a time, where as with the one switch method all of the sample must be added at once.

#### **Top-End Counting**

The total number of items in an unsealed container can be determined without removing the items from the container (except a sample). The container with parts is placed on the platform and the piece weight is calculated when a sample quantity is either added to (one switch) or removed from (two-switch operation) the container. Based on the piece weight, the total number of items in the container is displayed.

#### **Automatic Sample-to-Bulk Counting**

This method requires that the scale be configured with two bases, a "sample" and a "bulk" base. The lighter capacity "sample" base is used to calculate the piece weight, and the parts are counted on a heavier capacity "bulk" base. In most cases, higher counting accuracy is achieved with this method because the calculated piece is more precise when the sample is weighed on the light-capacity sample base. In normal operation, when the sample is placed on the sample base, the scale automatically switches to the bulk base and items to be counted are placed on the bulk base.

### **Counting by First Determining Error of Count (One-Switch Method using Automatic Sample Update)**

The percent error/accuracy of count can be updated by adding more items to the sample after the initial sample size is placed on the platform and the percent error/accuracy has been displayed. In normal operation, the sample is placed on the platform and a percent error/accuracy is momentarily displayed, followed by the count. More pieces are then placed on the platform in the range of 10% to 100% of the original sample. A new piece weight is calculated based on the larger sample size, and the new percent of error/accuracy will be momentarily displayed. This may continue until a satisfactory percent of error/accuracy is achieved.

### **Counting by First Determining Error of Count (Two-Switch Method)**

The percent error of count can be determined before the piece weight is established. Sample pieces are added to the platform until the percent of error/accuracy is acceptable. The sample size (number of pieces) is then keyed-in and entered, and the scale is ready to be used for counting.

### **Piece Weight Displayed as Weight Per 1000 Pieces**

If selected in calibration, the piece weight can be displayed as weight per 1000 pieces. This option is useful when the items being counted are very light and the piece weight for one item would be an extremely small number. When entering the piece weight through the keypad (for normal counting), enter the weight for 1000 items if the piece weight is to be displayed as weight per 1000 pieces.

### **Negative Counting**

This method is used to count the number of items removed from a container without first knowing the piece weight. The number of items removed from the container is shown on the display as a negative number.

### **Normal Operation with Two Switch Counting**

1. If a container will be used to hold items being counted, place it on the platform.
2. Press the SAMPLE SET button. The scale zeroes. "AddXXX" appears on the display (Where "XXX" is one of the four pre-programmed sample sizes.). Repeated pressing of the switch successively displays the four sample sizes entered during calibration.
3. If desired, a different sample size may be keyed into the scale. As this number is entered, the word "Add" will disappear and only the count indicator will be lit to indicate that the scale is in the sample entry mode.
4. The sample may now be placed onto the scale, all at once or one at a time. (If the percent of error feature has been selected in programming, the percent of error will be displayed as the parts are placed onto the platform. The more parts that are added, the lower the percent of error will be.)
5. Press the ENT button. The scale will switch to the count mode and display the sample count.
6. The remaining parts to be counted may now be placed onto the scale.

### **Normal Operation with Automatic Sample to Bulk Feature**

The second base option needs to be installed and calibrated for automatic sample to bulk to operate. Base one is always the sample base and base two is always the bulk base.

1. Press the BASE/1 switch to select the bulk base. (Base two indicator should be lit)
2. Press the ZERO switch to zero the bulk base.
3. If an empty container will be used to hold items on the bulk base place it on the platform and press either the ZERO or TARE switch.
4. If a full container will be counted on the bulk base. Place the container on the platform, press the KEYPAD TARE switch and key in the weight of the container, press ENT.
5. If a container will be used to hold the sample on base 1, place the container on the scale at this time.
6. Press the SAMPLE SET button. The scale will switch to the sample base (base 1). "AddXXX" will appear on the display (where "XXX" is one of the four pre-programmed sample sizes). Select the desired sample size by repeatedly pressing the SAMPLE SET switch, or key in an alternative sample size.
7. If the scale is programmed for a one-switch operation place the entire sample on the sample base all at one time. The scale will momentarily display the percent error/accuracy (If selected in calibration.), switch to the bulk base and enter the counting mode. The bulk base is now ready to count the parts.
8. If the scale is programmed for a two switch operation, place the sample parts onto the platform all at once or one at a time. The display will show the percent of error/accuracy (If selected in calibration.). When all of the sample parts are on the scale press ENT. The scale will switch to the bulk base and enter the count mode. The bulk base is now ready to count the parts.
9. At this point ZERO and TARE switches may be used without affecting the piece weight.

### **Top-End Counting (One-Switch Method; Sample Added)**

1. Press ZERO to zero the scale.
2. Place container with parts on the platform.
3. Press KEYPAD TARE, key in the tare weight of the container, then press ENT.
4. Remove the sample from the container.
5. Press the SAMPLE SET switch. "AddXXX" will appear on the display (where "XXX" is one of the four pre-programmed sample sizes). Select the desired sample size by repeatedly pressing the SAMPLE SET switch, or key in an alternative sample size. **IMPORTANT: The displayed sample size must equal the number of sample items removed.**
6. Place the sample pieces that were removed back into the container. The scale will momentarily display the percent error/accuracy (If selected in calibration.) and enter the count mode.
7. The display will show the total count for the items in the container.

### **Top-End Counting (Two-Switch method; Sample Removed)**

1. Press ZERO to zero the scale.
2. Press KEYPAD TARE, key in the tare weight of the container, then press ENT.
3. Place the container with contents on the platform and press the SAMPLE SET switch. "AddXXX" will appear on the display (where "XXX" is one of the four pre-programmed sample sizes). Select the desired sample size by repeatedly pressing the SAMPLE SET switch, or key in an alternative sample size.
4. Remove the displayed sample quantity from the container. The display will show the percent error/accuracy (If selected in calibration.). Press ENT.
5. The scale will enter the count mode and display the number of parts in the container.
6. Return the sample pieces to the container.

### **Counting by First Determining Error of Count using Automatic Sample Update (Normal Operation; One-Switch Method)**

1. If a container will be used to hold items being counted, place it on the platform.
2. Press the SAMPLE SET switch. "AddXXX" appears on the display (where "XXX" is one of the pre-programmed sample sizes). Select the desired sample size by repeatedly pressing the SAMPLE SET switch, or key in an alternative sample size.
3. Place the sample pieces on the platform simultaneously. The Percent error/accuracy will be momentarily displayed and the scale will enter the counting mode.
4. To either decrease the percent of error or increase the percent of accuracy, place more items on the platform in the range of 10% to 100% of the original sample quantity. A new piece weight is calculated based on the larger sample size, the new percent of error/accuracy is momentarily displayed and the scale returns to the count mode. This may continue until the desired percent error/accuracy is achieved.
5. Removing the original sample or adding a quantity of parts greater than the original sample will disable the automatic update feature.

### **Counting by First Determining Error of Count (Two-Switch Method)**

1. If a container will be used to hold the items being counted, place it on the platform.
2. Press the SAMPLE SET switch for two seconds. "AddXXX" will appear on the display (where "XXX" is one of the pre-programmed sample sizes). Select the desired sample size by repeatedly pressing the SAMPLE SET button or key in a new sample size.
3. Place the sample onto the platform all at one time (this should be done if the parts are extremely small) or count them onto the platform one at a time.
4. The display will show the percent error/accuracy. Continue to count parts onto the platform, as the sample increases the percent error will decrease and accuracy will increase. When the percent error/accuracy is acceptable key in the quantity of parts on the platform and press ENT.

### **Counting by First Determining Error of Count with Automatic Sample-To-Bulk Feature (Two-Switch-Method)**

1. Press the BASE/1 switch to select the bulk base. (BASE 2 light should be lit)
2. Press the ZERO to zero the bulk base.
3. If a container will be used to hold items on the bulk base, place the container on the platform and press ZERO or TARE.
4. If a container will be used to hold the sample parts, place it onto the sample base at this time.
5. Press the SAMPLE SET switch for two seconds. "AddXXX" will appear on the display (where "XXX" is one of the pre-programmed sample sizes). Select the desired sample size by repeatedly pressing the SAMPLE SET switch or key in a new sample size.
6. Place the sample onto the platform all at once (this should be done if the parts are extremely small) or count them onto the platform one at a time.
7. The display will show the percent error/accuracy. If the percent error/accuracy is not acceptable, continue to count parts onto the platform, as the sample increases the percent error will decrease and the percent accuracy will increase. When the percent error/accuracy is acceptable, key in the quantity of parts on the platform and press ENT.
8. The scale will switch to the bulk base. Items may now be counted on the bulk base.

### **Negative Counting, Sample Removed (Two Switch Method)**

1. With nothing on the scale platform, press the TARE to set tare to zero.
2. Place the container with contents on the platform.
3. Press the SAMPLE SET switch. "AddXXX" will appear on the display (where "XXX" is one of the four pre-programmed sample sizes). Select the desired sample size by repeatedly pressing the SAMPLE SET switch, or key in an alternative sample size.
4. Remove the displayed sample quantity from the container. The display will show the percent error/accuracy (If selected in calibration). Press ENT.
5. The scale will enter the count mode and display the number of parts removed from the container as a negative number. Removing pieces increases the negative count.

<b>MESSAGE</b>	<b>DESCRIPTION</b>
DAC	D/A card detected - Displayed under the check function.
IIC.ERR	IIC short - Power-up hardware failure indication.
RST	EEPROM is reset by EER command - Power-up message
ON	Displayed on power-up when the DC power push-button is pressed.
AUTO	EEPROM is reset - Power-up message
ERR6.x	Key-pad key is stuck.
-232-	Serial calibration/setup is active.
UPDATE	Enhancement calculation in progress.
LO.BATT	Low battery
D BATT	Dead battery
ULULUL	Under-load (-400 graduations under dead-zero)
OLOLOL	Over-load (+9 graduations or 105% from dead-zero reference)
-----	A/D acquisition is in progress.
7x00	Instrument mode selection.
Err 10	Number > 999999
Err 13	Number < -99999
ADC.Err	A/D hardware failure (channel one only).
CHECK	Check mode accessed.
rC.xxxx	Lower four-digits of the ROM check-sum.
Err.80	Serial command data error.
Err.81	Unknown serial command.
-CAL-	Remote calibration
Err.OFF	Hardware failure of the D.C. power on/off circuitry.
RTC.RST	The clock is reset to 01:01:04 12:00:00am.
RST ID	The ID EEPROM has been reset since it was detected as corrupt.
AC OK	Access code entered has been accepted.
E-1234	EEPROM set 1,2,3, and/or 4 have been fixed.
Err 40	Positive or negative signal overload (check sense connections).
Err 31	Bad tare entry
Err 30	Push to Zero out of range
PC Err	Piece Weight Entry is out of range

**STATUS CHARACTERS:**

@	Gr, pri, sta, non-zero	U	Net, sec, sta, zero
A	Gr, pri, sta, zero	V	Net, sec, unsta, non-zero
B	Gr, pri, unsta, non-zero	W	Net, sec, unsta, zero
C	Gr, pri, unsta, zero	X	OL/UL, Net, pri, sta
D	Gr, sec, sta, non-zero	Z	OL/UL, Net, pri, unsta
E	Gr, sec, sta, zero	\	OL/UL, Net, sec, sta
F	Gr, sec, unsta, non-zero	^	OL/UL, Net, sec, unsta
G	Gr, sec, unsta, zero	'	Cnt, pri, sta, non-zero
H	OL/UL, Gr, pri, sta	a	Cnt, pri, sta, zero
J	OL/UL, Gr, pri, unsta	b	Cnt, pri, unsta, non-zero
L	OL/UL, Gr, sec, sta	c	Cnt, pri, unsta, zero
N	OL/UL, Gr, sec, unsta	d	Cnt, sec, sta, non-zero
P	Net, pri, sta, non-zero	e	Cnt, sec, sta, zero
Q	Net, pri, sta, zero	f	Cnt, sec, unsta, non-zero
R	Net, pri, unsta, non-zero	g	Cnt, sec, unsta, zero
S	Net, pri, unsta, zero	h	OL/UL, Cnt, pri, sta
T	Net, sec, sta, non-zero	j	OL/UL, Cnt, pri, unsta
I	OL/UL, Cnt, sec, sta	n	OL/UL, Cnt, sec, unsta
p	Net, Cnt, pri, sta, non-zero	q	Net, Cnt, pri, sta, zero
r	Net, Cnt, pri, unsta, non-zero	s	Net, Cnt, pri, unsta, zero
t	Net, Cnt, sec, sta, non-zero	u	Net, Cnt, sec, sta, zero
v	Net, Cnt, sec, unsta, non-zero	w	Net, Cnt, sec, unsta, zero
x	OL/UL, Net, Cnt, pri, sta	z	OL/UL, Net, Cnt, pri, unsta

**115 to 220 VAC Conversion : EW1000 Bottom Side**

