

# 8100IS Series

---

Intrinsically Safe Indicator

## Technical Manual





## Table of Contents

Introduction .....	1
Specifications .....	2
Scale Operation .....	3
Scale Annunciators .....	3
Power Up and Power Down .....	4
ZERO .....	4
Push Button Tare .....	4
Display TARE value .....	5
GROSS NET .....	5
UNITS .....	5
PRINT .....	5
Display Accumulator and Counter Values .....	5
Clear Accumulator and Counter .....	5
Accumulator and Counter Data String Output to Printer or Other Device .....	6
Accumulator and Counter Operation .....	6
Calibration Mode .....	7
Power-up Front Panel Setup Mode Access .....	7
Front Panel Setup Mode Access .....	7
Switch Setup Mode Access .....	7
Exiting the Setup Mode .....	7
Select Scale Capacity .....	8
Select Scale Resolution .....	8
Zero and Span Calibration .....	8
A/D Range Troubleshooting .....	10
Parameter Setup Mode .....	11
Power-up Front Panel Setup Mode Access .....	11
Front Panel Setup Mode Access .....	11
Switch Setup Mode Access .....	11
Exiting the Setup Mode .....	11
Stepping Through Menu Parameters .....	12
Changing Parameter Settings .....	12
Parameter Review of Calibration and Setup Values .....	12
Calibration and Audit Counters .....	12
Resetting the scale parameters: .....	12
Data Communications .....	23
Standard Print String Formats .....	23
Custom Data String Configuration .....	27
Custom Data String Control Characters .....	28
Remote Setpoint / Preact / Limit Entry and Recall .....	30
Remote Product ID Entry and Recall: .....	30
Remote Product Description Entry and Recall: .....	31
Remote Tare Entry and Recall: .....	31
Remote Data Field Entry and Recall: .....	32
Data Print Buffer .....	32
Installation Instructions .....	37
Removing the Rear Panel .....	37
Cable Glands .....	37
Internal Power Connections .....	38
Load Cell Connections .....	38

Scale Installation.....	39
Electrical Ratings .....	40
Installation with the 8BIS Battery .....	41
Battery Installation .....	41
Battery Pack Operation.....	42
Installation with the 8AIS AC Power Supply.....	44
AC Power Supply Installation in Hazardous Location.....	44
AC Power Supply Installation In Safe Areas .....	45
Extension Cable.....	45
Remote Switch Connections .....	46
Hazardous Area Fiber Optic Option .....	47
8FB Safe Area Fiber Optic Option .....	48
Installation .....	48
Remote Display Option .....	49
Troubleshooting .....	50
General problem resolution:.....	50
Scale Messages: .....	51
Error Messages: .....	52

# Introduction

Thank you for purchasing a Doran Scales Model 8100IS Intrinsically Safe indicator. The Model 8100IS indicator for Hazardous Locations is designed to provide consistent reliability in the most demanding environments.

This manual describes the installation, operation and functionality of the 8100IS Intrinsically Safe Indicator. Please be sure to read the entire manual and control drawings to ensure that you obtain all the benefits that the 8100IS series can provide. If any questions arise, please feel free to contact the Doran Scales Technical Support Department at 1-800-879-1288.

Doran Scales, Inc.  
883 Enterprise Ct.  
St. Charles, IL 60174



E485121

# Specifications

UL Certificate Number	20190304-E485121
Enclosure	304 Stainless Steel
Product Dimensions	10" W x 6.75" H x 3.5" D
Environmental Protection	IP6X
Temperature Range	14 F to 104F (-10 C to +40 C) 8CHG only: 14 F to 86 F (-10 C to +30 C)
Altitude	Up to 2000 meters
Resolution Range	200d to 100,000d
Humidity	Maximum relative humidity 95%, non-condensing
Pollution Degree	2
Analog Signal Sensitivity	0.16 $\mu$ V/e minimum, 0.5 $\mu$ V/e typical
System Linearity	0.01% full scale
Analog Signal Range	-0.5mV/V to 5 mV/V with 4 and 6 wire input
Excitation Voltage	5 VDC
Number of Load Cells	Up to 4 350 Ohm, 4 or 6 wire
Load Cell Entity Parameters	Load cells must be certified for appropriate hazardous area and entity parameters. See note one on control drawing 900243  Uo 7.14 V, Io 0.7076 A, Po 0.895 W, Co 10.8 $\mu$ F, Lo 71 $\mu$ H
Scale Inputs	One
Calibration Range	Calibrate between 2% and 100% of capacity
Power Input	100 VAC 50/60Hz
Battery Option	Rechargeable Sealed Lead Acid Battery Charging time 36 for 8 hours of continuous use, 1000 recharge cycles
Display	1" high, 6 digit backlit LCD
Displayed Units	lb, kg, oz, g, lb:oz
Capacity Range	1 to 999,000 lb
Communication Options	Fiber Optic to RS-232 Output
Remote Switch Input	Two remote switch inputs

# Scale Operation

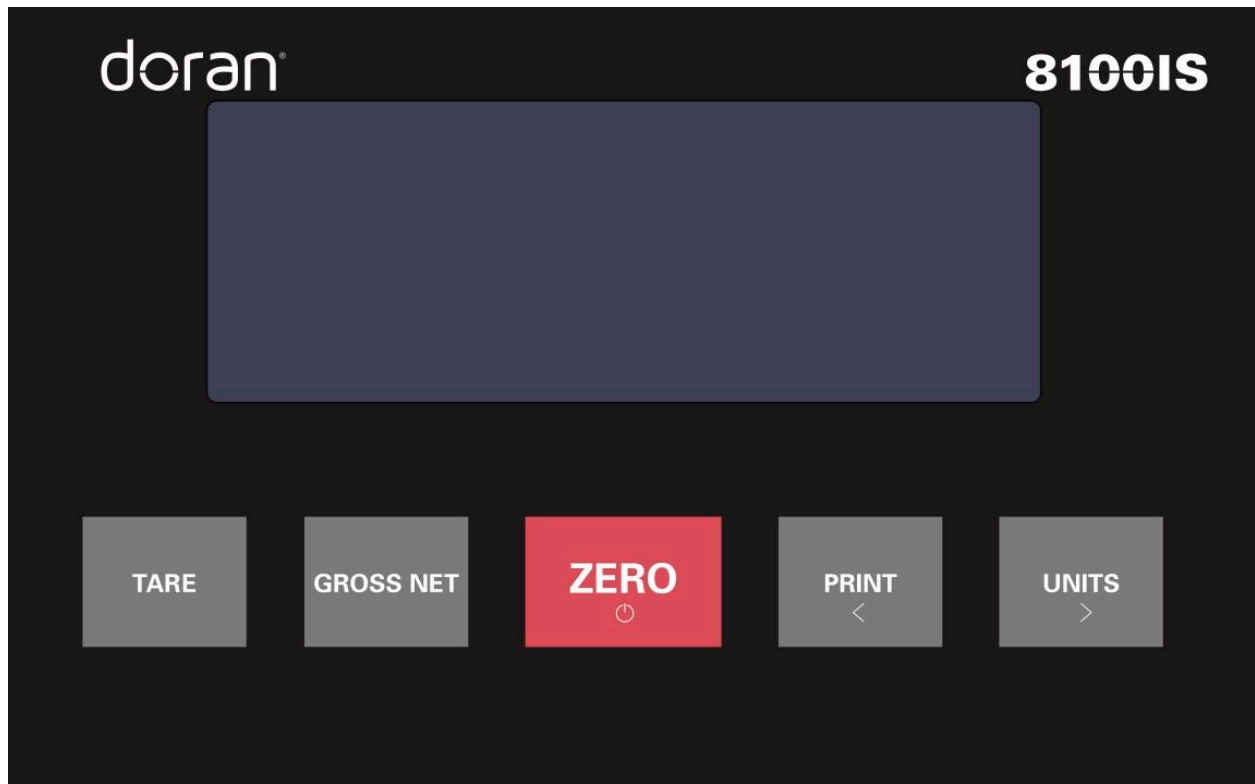

Fig. 1: Model 8100IS Front Panel Layout

## Scale Annunciators

Unit of measure lb, oz, kg, g or lb:oz. The units annunciator to the right of the display will indicate the current unit of measure.

NET Net weighing mode is indicated by the NET annunciator. The annunciator will illuminate when a net weight is displayed. When not illuminated, a gross weight is displayed.

 Low battery condition is indicated by the display flashing  $\text{Lo BATT}$ .

$\blacktriangleright 0 \blacktriangleleft$  Center of zero. The annunciator will illuminate while the scale is displaying a zero weight.

MOTION Motion indicator. This symbol represents motion or instability of the weight. The annunciator will illuminate when motion is sensed on the platform. Changes in weight, vibration or air currents can cause the scale to go into motion.

$\underline{Q}$  Displays in lower left corner of display when data has been transmitted

## **Power Up and Power Down**

Connect the indicator to the 8BIS or 8AIS power supplies with supplied cabling only.

For scales with battery:

- Turn on the scale by pressing the ZERO button.
- To turn off, press and hold the ZERO push button until the display shows "r E1 P h." Then release the ZERO button and the scale will turn off.
- The scale will turn off automatically when the scale is stable for a period of time defined by the Unit On Timer parameter. The default setting is 30 seconds.

## **ZERO**

ZERO is used to zero the scale. To zero the scale, press the ZERO button. The scale will not zero if the scale is in motion. The zero function will operate over the entire capacity of the scale.

If the scale is displaying a net weight, pressing ZERO will return the scale to gross mode and display a zero weight. The stored tare will remain in memory.

The scale is equipped with a Zero on Demand parameter which zeros the scale upon the next stable reading after ZERO is pressed.

NOTE: When configured for Batch Operating mode, the ZERO button is disabled when the batch sequence is running.

## **Push Button Tare**

Place the item you wish to tare on the scale platform and press TARE. The scale will display a net weight and the NET annunciator will illuminate.

Tare weights will remain in memory even if the indicator is turned off.



### **Display TARE value**

To display the current tare value, press and hold TARE for three seconds. The display will briefly read  $\bar{t}$   $\bar{R}$   $\bar{E}$  then flash the tare weight in the currently selected units. To exit press TARE.

### **GROSS NET**

Press the GROSS NET button to switch between the gross and net weighing mode. Switching to the net mode is possible only when a tare is entered. Net mode is indicated when the NET annunciator is illuminated.

NOTE: When configured for Batch Operating mode, the GROSS / NET push button is disabled when the batch sequence is running.

### **UNITS**

UNITS selects the unit of measure. Press UNITS to change the current unit. The units annunciator to the right of the display will indicate the current unit or measure: lb,oz, kg, g or lb:oz.

Each unit can be enabled or disabled in the scale parameter setup. Lb:oz is disabled by default. Lb:oz is not available for checkweigh or setpoint values.

NOTE: When configured for Batch Operating mode, the UNITS button is disabled when the batch sequence is running.

### **PRINT**

PRINT transmits data to a printer or other external devices. When the data is transmitted, Q will display in the lower left corner to confirm data transmission.

### **Display Accumulator and Counter Values**

Press the ACCUM button (hidden button next to the display) to enter the accumulator and counter recall mode. The display will show  $\bar{A}$   $\bar{C}$   $\bar{C}$   $\bar{U}$   $\bar{M}$  followed by the accumulated weight in the units currently selected in the weigh mode. Then  $\bar{C}$   $\bar{U}$   $\bar{N}$   $\bar{T}$   $\bar{E}$  will be displayed followed by the counter value.

Press ACCUM to exit the accumulator and counter recall mode without changing their values.

### **Clear Accumulator and Counter**

Press the ACCUM button to enter the accumulator and counter recall mode. The display will show  $\bar{A}$   $\bar{C}$   $\bar{C}$   $\bar{U}$   $\bar{M}$  followed by the accumulated weight in the units currently selected in the weigh mode. Then  $\bar{C}$   $\bar{U}$   $\bar{N}$   $\bar{T}$   $\bar{E}$  will be displayed followed by the counter value.

Press ZERO to clear the accumulator and counter values. The display will show  $\bar{C}$   $\bar{L}$   $\bar{R}$   $\bar{A}$  and exit from the recall mode.

Changing the current display units will clear both the accumulator and counter values.

### **Accumulator and Counter Data String Output to Printer or Other Device**

Press ACCUM to enter the accumulator recall mode. Press PRINT to transmit the LB4 custom data string that contains the accumulator and counter values by default. Both the accumulator and counter values are cleared after transmission.

See Output Formats in the parameter section and Custom Data String default settings for more details.

### **Accumulator and Counter Operation**

When a manual or automatic print function is executed, the accumulator has the currently displayed weight added to its' current value and the counter is incremented. To confirm an accumulation and counter operation, the left most display digit will momentarily display an  $\alpha$ .

To automatically accumulate, select an auto print function in the parameter setup menu.

To accumulate manually, allow the scale to become stable and press PRINT.

The maximum value that can be shown for the accumulator and counter is 999,999. When the maximum value is reached, the accumulator and counter will rollover to a zero value. This feature can only be used in a non Legal For Trade application.

When configured for 250 product memory, the Accumulator and Counter values are stored with the associated Product ID number.

# Calibration Mode

To calibrate the 8100IS indicator, you must access the setup mode. Any of the three methods below can be utilized.

## Power-up Front Panel Setup Mode Access

To enter the calibration mode, power up the indicator while pressing and holding the ZERO and the UNITS buttons. When  $r \text{ E1 } P_b$  is displayed, release both buttons. The display will momentarily read  $E_n t \text{ C} d$ , and then go blank. Press the ZERO button five times. The display will indicate the number of times the ZERO button has been pressed. When  $5$  is displayed, press the UNITS button and wait a few seconds.

Note: If the code is not entered before the timer is finished, the scale will bypass code entry and enter the normal run mode. The front panel access feature during power-up is not available when the Operating Mode ( $a^P$ ) parameter is set to  $445$ .

## Front Panel Setup Mode Access

To enter the calibration mode, press and hold the UNITS and ZERO buttons until the parameter review starts ( $C$  and  $P$  are displayed). Press the HIDDEN (Capacity Label) button after  $C R P \text{ A} d$  and the capacity is displayed. The display will momentarily read  $E_n t \text{ C} d$ , and then go blank. Press the ZERO button five times. The display will indicate the number of times the ZERO button has been pressed. When  $5$  is displayed, press the UNITS button and wait a few seconds.

Note: If the code is not entered before the timer is finished, the scale will bypass code entry and enter the normal run mode. The front panel access feature during power-up is not available when the Operating Mode ( $a^P$ ) parameter is set to  $445$ .

## Switch Setup Mode Access

The calibration switch can be accessed by removing the meter's back cover. With the indicator powered on, press the CAL switch (S1), located in the lower left corner of main board. Pressing the CAL switch also exits the setup mode and saves any changes.

Warning: do not press the CAL switch while powering up scale, this will cause the scale to reset all parameter settings.

## Exiting the Setup Mode

To exit the Calibration and Parameter Setup Menu, momentarily press the CAL switch or scroll through the menu options, by pressing the UNITS button, until  $d a n E n$  appears. Press the ZERO button until  $d a n E 5$  appears and then press the UNITS button. The indicator will return to the normal weighing mode. If any menu selections were changed, the new values will be saved.

Note: No new setup information is saved until the scale displays  $5 R U E d$  and returns to the weigh mode. In the event of a power failure while in the setup mode, any changes that have been made will be lost.

## **Select Scale Capacity**

When the setup mode is accessed, the first parameter displayed is the capacity parameter. The capacity parameter toggles the display between  $\overline{CAP}$   $\overline{RD}$  and the current capacity. The capacity can be expressed in lb or kg. The UNITS annunciator to the right of the weight display will indicate either lb or kg. The calibration and capacity setup unit is defined by the startup units  $\overline{UN}$   $\overline{b5}$  parameter setting.

To change the capacity, press ZERO. The right most digit will flash. Press ZERO until the flashing digit has the desired value. Press UNITS to select the next digit to the left. Once entered, press UNITS until the display reads  $\overline{CAP}$   $\overline{b5}$ .

## **Select Scale Resolution**

After the capacity has been entered, the resolution (count-by) will automatically be set for 5000 divisions. To enter a different resolution, press the UNITS button until the display momentarily shows  $\overline{RES}$   $\overline{b5}$  and then displays the current resolution.

The resolution can be a value between 200 and 50,000 divisions of capacity. The UNITS annunciator to the right of the weight display will indicate either lb or kg. Press the ZERO button to increment through the available range of possible resolutions. Once maximum resolution has been reached, the level will roll over to the minimum value.

## **Zero and Span Calibration**

Press the UNITS button until  $\overline{CAL}$   $\overline{0}$  appears on the display. Remove all weight from the scale platter. To ensure fast and accurate calibration, be sure there are no air currents or vibration present.

Press ZERO and wait for the display to count down to 0. If the calibration zero is accepted, the display will read  $\overline{CAL}$   $\overline{F5}$ . If the display reads  $\overline{CAL}$   $\overline{0}$ , repeat the zero point calibration process.

NOTE: If  $\overline{ERR}$   $\overline{nn0}$  appears during the calibration count down, the scale is in motion. All vibrations and air currents must be removed from the scale platform to complete the calibration process.

NOTE: If  $\overline{ERR}$   $\overline{nE9}$  appears on the display, the calibration zero is out of range. Press ZERO to clear the error. Refer to the A/D Ranging section for additional information.

The span point can be calibrated using any weight between 2% and 100% of scale capacity. To perform the span calibration, place the calibration weight on the platform. Press UNITS to select between full scale capacity ( $\overline{F5}$ ), 75% ( $\overline{.75}$ ), 50% ( $\overline{.50}$ ), 25% ( $\overline{.25}$ ), 20% ( $\overline{.20}$ ) and 10% ( $\overline{.10}$ ). Alternatively, you can press PRINT and scroll to the desired weight using PRINT and UNITS. When the desired weight is selected, press ZERO to perform a span calibration. Wait for the display to count down to 0. If the span calibration is successful, the display will return with  $\overline{span}$ .

If the display returns to  $\overline{CAL}$   $\overline{0}$ , the A/D is auto ranging, and you will need to repeat the zero and span calibration process.

NOTE:

If  $\text{E}r \text{ dP}$  appears on the display, the calibration span weight value has an incorrect decimal point location.

If  $\text{E}r \text{ c n t}$  appears on the display, the calibration span weight value has a count by resolution greater than that of the indicator's count by resolution.

If  $\text{E}r \text{ nEg}$  appears on the display, the calibration span is in a negative range. Check polarity of load cell connection and repeat zero and span calibration.

If  $\text{SPRn E}$  appears on the display, the calibration span is out of range. Press ZERO to clear this error. Refer to the A/D Ranging section for additional information.

**WARNING:** Calibration at 2% of capacity has been provided as a convenience to customers with high capacity scales in remote or inaccessible locations. Scales calibrated at 2% of capacity may have more errors at full capacity than scales calibrated at 25% or 50%. Doran Scales recommends that all scales be calibrated at full capacity whenever possible.

## **A/D Range Troubleshooting**

On scales with factory installed platforms, the zero and span will lie within permissible limits. The allowable load cell signal input range is from 0.112 mV/V to 7 mV/V.

- 1) Enter the calibration mode.
- 2) Press PRINT until the A/D raw counts are displayed.
- 3) Remove all items from the platform and record the dead load raw counts reading.
- 4) The dead load raw counts must be between -50,000 and 1,900,000 counts. If the readings are outside of the limits specified, change the dead load until you meet these requirements.
- 5) Place full capacity on the platform and record the raw counts. Subtract the dead load counts from the full load counts to calculate the span. Refer to Table 1 and verify that the span falls within the specified range. The "Full Load" raw counts (span + dead load) should not exceed 1,999,999 counts.
- 6) When using 75%, 50%, 25%, 20% or 10% of full load to calibrate, refer to Table 1 for full load, 75%, 50%, 25%, 20%, 10% span ranges.

Platform load	Minimum span
Full	30,000
75%	22,500
50%	15,000
25%	7,500
20%	6,000
10%	3,000

**Table 1: Calibration requirements in raw counts**

# Parameter Setup Mode

The indicator provides many parameters that allow you to customize the operation of your indicator to meet your application's needs. To access these parameters the setup mode must be accessed, which can be entered using any of the three methods below.

## **Power-up Front Panel Setup Mode Access**

To enter the calibration mode, power up the indicator while pressing and holding the ZERO and the UNITS buttons. When  $r \text{ E L } P \text{ b}$  is displayed, release both buttons. The display will momentarily read  $E \text{ n t } L \text{ d}$ , and then go blank. Press the ZERO button five times. The display will indicate the number of times the ZERO button has been pressed. When  $5$  is displayed, press the UNITS button and wait a few seconds.

Note: If the code is not entered before the timer is finished, the scale will bypass code entry and enter the normal run mode. The front panel access feature during power-up is not available when the Operating Mode ( $a \text{ P}$ ) parameter is set to  $445$ .

## **Front Panel Setup Mode Access**

To enter the calibration mode, press and hold the UNITS and ZERO buttons until the parameter review starts ( $L$  and  $P$  are displayed). Press the HIDDEN button, located to the right of the display after  $L \text{ R P } R \text{ d}$  and the capacity is displayed. The display will momentarily read  $E \text{ n t } L \text{ d}$ , and then go blank. Press the ZERO button five times. The display will indicate the number of times the ZERO button has been pressed. When  $5$  is displayed, press the UNITS button and wait a few seconds.

NOTE: If the code is not entered before the timer is finished, the scale will bypass code entry and enter the normal run mode. The front panel access feature during power-up is not available when the Operating Mode ( $a \text{ P}$ ) parameter is set to  $445$ .

## **Switch Setup Mode Access**

The calibration switch can be accessed by removing the meter's back cover. With the indicator powered on, press the CAL switch (S1), located in the lower left corner of the main board. Pressing the CAL switch also exits the setup mode and saves any changes.

Warning: do not press the CAL switch while powering up the scale, this will cause the scale to reset all parameter settings.

## **Exiting the Setup Mode**

To exit the Calibration and Parameter Setup Menu, momentarily press the CAL switch or scroll through the menu options, by pressing the UNITS button, until  $d \text{ a n } E \text{ n}$  appears. Press the ZERO button until  $d \text{ a n } E \text{ n } 5$  appears and then press the UNITS button. The indicator will return to the normal weighing mode. If any menu selections were changed, the new values will be saved.

Note: No new setup information is saved until the scale displays  $5 \text{ R U } E \text{ d}$  and returns to the weigh mode. In the event of a power failure while in the setup mode, any changes that have been made will be lost.

## Stepping Through Menu Parameters

Once the Calibration and Parameter Setup Mode has been entered, you may step through the menu by pressing UNITS or PRINT. Press the CLEAR button to jump to the end of the menu section. Some items in the menu contain sub menus, which can be entered by selecting  $\overline{\text{ZERO}}$  by pressing ZERO and then UNITS.

See the Parameter Configuration section on the following pages for details on each setting.

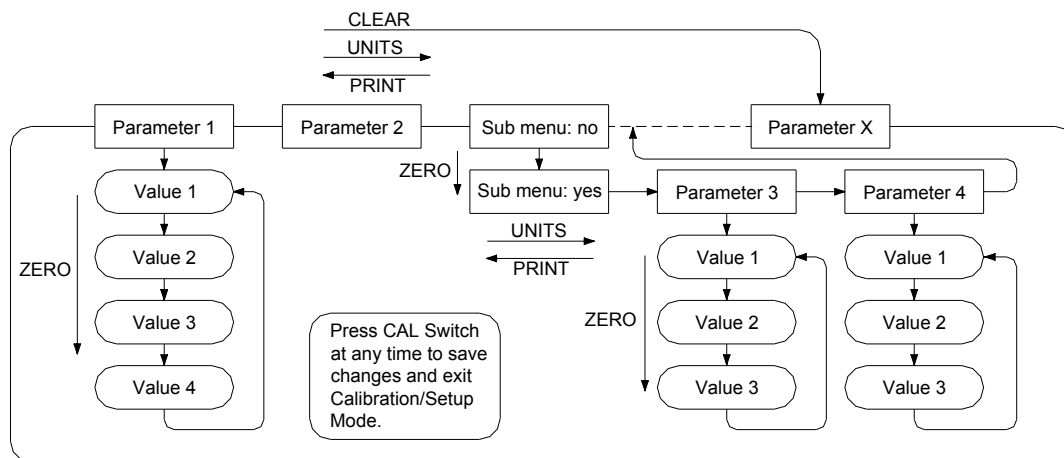

## Changing Parameter Settings

After finding the desired parameter, the settings for that parameter may be changed. Press the ZERO button to scroll through the list of settings for that item. The list of choices will repeat after you have scrolled through all available settings for that parameter. When you have found the desired setting, press UNITS or PRINT to go to the next or previous menu item.

## Parameter Review of Calibration and Setup Values

The parameter settings for the indicator may be quickly reviewed without entering the setup mode. With the indicator powered up, press and hold UNITS and ZERO until the indicator begins to scroll through each of the parameters. After all parameters are displayed, the indicator will then enter the weighing mode automatically.

## Calibration and Audit Counters

When entering calibration mode, the parameter audit counter and the calibration audit counter will momentarily be displayed. The parameter audit counter only increments when  $\overline{\text{CRP}}$ ,  $\overline{\text{CnE}}$ ,  $\overline{\text{bY}}$ ,  $\overline{\text{AZt}}$ ,  $\overline{\text{nn.R.}}$ ,  $\overline{\text{SUQ}}$ ,  $\overline{\text{SP}}$  values are changed. The calibration audit counter increments when a successful zero calibration and span calibration are performed.

## Resetting the scale parameters:

If at some point the user wishes to return all parameters to factory default settings, follow these steps.



- Enter the Setup mode and press the UNITS button to scroll to menu item "၎်း၎်း".
- Press the ZERO button to select "၎်း၎်း ၂". Press the UNITS button and the display will show "၎်း၎်း ၈".
- Press the ZERO button to select "၎်း၎်း ၂" to default all parameter and calibration settings, except for zero & span calibration levels. OR
- Press the ZERO button twice to select "၎်း၎်း ၂" to default all parameter and calibration settings, including zero & span calibration levels.

**WARNING: Using "၎်း၎်း ၂" selection to default the scale will require a complete recalibration.**

- Press the UNITS button to default the scale.
- The scale will then display "၈်း ၈်း" or "၈်း ၈်း ၂" and "၎်း၎်း၎်း". After the "၎်း၎်း၎်း" message is displayed the scale will then perform its normal power up routine and enter the Setup mode. All parameters have been reset to their factory default settings.
- If necessary, calibrate the indicator. Refer to the Calibration Mode Section for calibration instruction, or exit the Setup mode to return to the weighing mode.

**Note:** A second method to default parameter settings only is by holding the CAL push button while powering up scale. The indicator will display "၎်း၎်း ၎်း" until the CAL button is released, then show "၈်း ၈်း" and "၎်း၎်း၎်း".

### Capacity Setup Menu

<b>[CAP ADJ]</b>	<b>Capacity Adjustment Menu</b> Allows the selection of scale capacity.
1 - 999000	1 lb / kg to 999,000 lb / kg

NOTE: Capacities  $\geq$  60,000 lb, oz units are disabled.  
 Capacities  $\geq$  2000 lb, grams units are disabled  
 Capacities  $\geq$  1000 lb, lb-oz units are disabled

### Count By Setup Menu

<b>[Cnt by]</b>	<b>Resolution Setup Menu (Count By)</b> Allows the selection of scale division size.
0.00002 5000	0.00002 lb / kg to 5000 lb / kg Selection with be limited by capacity.

### Calibration Menu

<b>[CAL 0]</b>	<b>Zero Point Calibration</b>
	See Calibration Mode section for calibration instructions

<b>[CAL]</b>	<b>Span Point Calibration</b> (Appears only after a successful Zero Calibration)
XXXXXX	Use the numeric buttons to enter in weight value.
<b>F5</b>	<b>Full load calibration.</b>
.75	3/4 capacity calibration.
.50	Half capacity calibration.
.25	Quarter capacity calibration.
.20	1/5th of capacity calibration.
.10	1/10th of capacity calibration.

### Digital Filter Setup Menu

<b>[Avg]</b>	<b>Averaging mode</b> Determines the number of samples to average
0	1 reading, not averaged.
1	Circular auto averaging, 1 reading is averaged while weight is in motion, 4 readings while stable.
<b>2</b>	<b>Circular auto averaging, 2 readings are averaged while weight is in motion, 8 readings while stable.</b>
4	Circular auto averaging, 4 readings are averaged while weight is in motion, 16 readings while stable.
8	Circular auto averaging, 8 readings are averaged while weight is in motion, 32 readings while stable.
16	Circular auto averaging, 16 readings are averaged while weight is in motion, 64 readings while stable.

### Automatic Zero Tracking Setup Menu

<b>AZT</b>	<b>Automatic Zero Tracking Range</b> <b>Small weights within the specified number of divisions are automatically zeroed.</b>
OFF	Zero tracking is off. No automatic zeroing.
<b>0.5</b>	<b>Zero tracking to within 0.5 divisions.</b>
1*	Zero tracking to within 1.0 division.
2*	Zero tracking to within 2.0 divisions.
3*	Zero tracking to within 3.0 divisions.
5*	Zero tracking to within 5.0 divisions.
10*	Zero tracking to within 10.0 divisions.
20*	Zero tracking to within 20.0 divisions.

\* NOTE: These items are disabled in the Legal for Trade mode.

### Motion Aperture Setup Menu

<b>MA*</b>	<b>Motion aperture *</b> <b>Determines how many divisions consecutive readings must change before the scale is considered in motion.</b>
0.5	0.5 division change must be seen to enter motion.
<b>1</b>	<b>1 division change must be seen to enter motion.</b>
2	2 division change must be seen to enter motion.
3	3 division change must be seen to enter motion.
5	5 division change must be seen to enter motion.
10	10 division change must be seen to enter motion.
20	20 division change must be seen to enter motion.

### Start Up Zero Setup Menu

<b>SUZ*</b>	<b>Start Up Zero</b> <b>Controls the start up zero function.</b>
ON	<b>Zeros on the first stable reading on power up.</b>
CL0	Loads the calibration zero for zero reference
PB0*	Loads the last pushbutton zero. (Disabled in LFT mode)

### Tare Entry Menu

<b>TER</b>	<b>Tare Entry</b>
<b>PBn</b>	<b>Push button &amp; digital tare entry.</b>
n	Digital tare entry.
Pb	Push button tare entry only.
OFF	Tare entry is disabled.

### Latching Zero Request Setup Menu

<b>Zod</b>	<b>Zero on Demand Enable or disable zero latching.</b>
<b>on</b>	If ZERO is pressed, it is saved until the scale becomes stable.
<b>off</b>	<b>If the scale is in motion, the zero request is discarded.</b>

### Latching Print Request Setup Menu

<b>Pod</b>	<b>Print on Demand Enables or disables print latching.</b>
<b>on</b>	If PRINT is pressed, the print request is saved until the scale becomes stable.
<b>off</b>	<b>If the scale is in motion, the print request is discarded.</b>

## Printer Data Output Setup Menu

<b>d.o.</b>	<b>Data Output Mode</b> <b>Determines when serial data will be sent out of serial port 1.</b>
<b>t.o.d.</b>	<b>Transmit on demand. The current stable weight is transmitted whenever the PRINT button is pressed, a remote PRINT button is pressed, or a print request is received via communications options.</b>
<b>R.P.1</b>	Auto Print 1 transmits the first stable weight reading above the threshold level.
<b>R.P.2</b>	Auto Print 2 transmits the first stable weight reading that is above the threshold level. Once a weight has been transmitted, no further weights will be transmitted until the scale returns to a weight below the threshold level. The default setting for the threshold level is 1% of scale capacity. To adjust the threshold level, see the Threshold Level parameter.
<b>R.P.4</b>	The first stable weight, above the threshold, is recorded. When the weight falls below the threshold, this recorded weight is transmitted. No further weight is transmitted until the weight stabilizes above the threshold once again and the process repeats. The default setting for the threshold level is 1% of scale capacity. To adjust the threshold level, see the Threshold Level parameter. Display will show a "ε" to indicate weight has been captured.
<b>R.P.5</b>	The last stable weight, above the threshold, is recorded. When the weight falls below the threshold, this recorded weight is transmitted. No further weight is transmitted until the weight stabilizes above the threshold once again and the process repeats. The default setting for the threshold level is 1% of scale capacity. To adjust the threshold level, see the Threshold Level parameter.
<b>C.P.</b>	In continuous print, data is transmitted each time the scale updates the weight display. Display updates that occur while the scale is in motion are identified by the abbreviation "MOT." following the weight data. The Digital Filter Setup parameter controls the number of data transmissions per second.

## Output Format

<b>For</b>	<b>Data Output Format of Fiber Optic Port (see Data output format)</b>
<b>F0</b>	<b>Basic output format (8,n,1)</b>
<b>F1</b>	Enhanced output includes grade status.
<b>d3</b>	Serial protocol for control box (Sets baud rate to 57.6K)
<b>nb</b>	Future use
<b>Lb1</b>	Select Custom Data String 1 (user defined print string)
<b>Lb2</b>	Select Custom Data String 2 (user defined print string)
<b>Lb3</b>	Select Custom Data String 3 (user defined print string)
<b>Lb4</b>	Select Custom Data String 4 (user defined print string) (Used for Accumulator / Counter Print Command)
<b>rd</b>	Remote Display Option (Port 1's baud rate set to 57.6K with serial output continuously transmitting, See Remote Display Option for details.)

## Baud Rate Setup Menu

<b>br.</b>	<b>Baud Rate Setup, Serial Port 1 Determines baud rate for serial data.</b>
<b>12</b>	1200 baud (bits per second)
<b>24</b>	2400 baud (bits per second)
<b>48</b>	4800 baud (bits per second)
<b>96</b>	<b>9600 baud (bits per second)</b>
<b>14.4</b>	14,400 baud (bits per second)
<b>19.2</b>	19,200 baud (bits per second)
<b>28.8</b>	28,800 baud (bits per second)
<b>38.4</b>	38,400 baud (bits per second)
<b>48.0</b>	48,000 baud (bits per second)
<b>57.6</b>	57,600 baud (bits per second)

## Handshaking Setup Menu

<b>H5</b>	<b>Serial Data Output Handshaking (Port 1 only) Selects the type of serial data handshaking used. (See the Data Communication section for details)</b>
<b>5F</b>	<b>Software handshaking. The software handshaking option activates Bi-directional RS232 communications. Refer to the communications section for details.</b>
<b>aFF</b>	Disables all RXD communications.
<b>bUF</b>	Turns on Print Buffer on port 1.
<b>rd</b>	Indicator configured to operate as a remote display and keyboard interface. Port 1 use for Communication. (See Remote Display Option for details.)
<b>!a</b>	Turns on setpoint communication mode (Port 1's baud rate set to 57.6K with serial output continuously transmitting)

### Units Conversion Setup Menu

<b>UCL</b>	<b>Convert Select Modes</b> Determines which units selections will be active.	
<b>no</b>	<b>Do not enter Convert selection menu.</b>	
<b>YES</b>	Enter Convert selection menu.	
	<b>lb</b>	<b>pounds menu</b>
	<b>on</b>	<b>lb is active</b>
	<b>off</b>	lb is non active
	<b>kg</b>	<b>kilograms menu</b>
	<b>on</b>	<b>kg is active</b>
	<b>off</b>	kg is non active
	<b>oz</b>	<b>ounces menu</b>
	<b>on</b>	<b>oz is active</b>
	<b>off</b>	oz is non active
	<b>gr</b>	<b>grams menu</b>
	<b>on</b>	<b>g is active</b>
	<b>off</b>	g is non active
	<b>Lo*</b>	<b>pound-ounces menu (Disabled in LFT mode)</b>
	<b>off*</b>	<b>lb-oz is non active</b>
<b>on*</b>	lb-oz is active	

### Start Up Units Selection Menu

<b>Unit</b>	<b>Start Up Units Select Mode</b> Configures selection of start up units.
<b>lb</b>	Press ZERO to scroll through the units activated in the Units parameter. The selected units will be displayed on the units indicators to the right of the display.

NOTE: If an invalid start up unit is selected for a given capacity, the scale will automatically change the unit setting to the next valid unit.

## Push-button Function Setup Menu

<b>P.b.</b>	<b>Configures push button and remote push buttons.</b>	
<b>no</b>	<b>Do not enter push button selection menu.</b>	
<b>YES</b>	Enter push button selection menu.	
	<b>gn</b>	<b>GROSS NET push button menu</b>
	<b>on</b>	<b>pb is active</b>
	<b>oFF</b>	pb is non active
	<b>Ac</b>	<b>ACCUM push button menu</b>
	<b>on</b>	<b>pb is active</b>
	<b>oFF</b>	pb is non active (disables accumulator)
	<b>prt</b>	<b>PRINT push button menu</b>
	<b>on 1</b>	<b>pb is active on port 1</b>
	<b>oFF</b>	pb is non active
	<b>ut</b>	<b>UNITS push button menu</b>
	<b>on</b>	<b>pb is active</b>
	<b>oFF</b>	pb is non active
	<b>zr</b>	<b>ZERO push button menu</b>
	<b>on</b>	<b>pb is active</b>
	<b>oFF</b>	pb is non active
	<b>tr</b>	<b>TARE push button menu</b>
	<b>on</b>	<b>pb is active</b>
	<b>oFF</b>	pb is non active
	<b>r 1</b>	<b>REMOTE SWITCH 1 menu</b>
	<b>oFF</b>	Remote sw is non active
	<b>zr</b>	<b>Remote sw = ZERO pb</b>
	<b>ut</b>	Remote sw = UNITS pb
	<b>prt</b>	Remote sw = PRINT pb
	<b>Ac</b>	Remote sw = ACCUM pb
	<b>tr</b>	Remote sw = TARE pb
	<b>gn</b>	Remote sw = GROSS NET pb
	<b>r 2</b>	<b>REMOTE SWITCH 2 menu</b>
	<b>oFF</b>	Remote sw is non active
<b>zr</b>	<b>Remote sw = ZERO pb (r !)</b>	
<b>ut</b>	Remote sw = UNITS pb	
<b>prt</b>	<b>Remote sw = PRINT pb</b>	
<b>Ac</b>	Remote sw = ACCUM pb	
<b>tr</b>	Remote sw = TARE pb	
<b>gn</b>	Remote sw = GROSS NET pb	



### Operating Mode Setup Menu

0P *	<b>Operating mode</b> <b>Activates the Legal for Trade mode.</b>
5td	<b>Standard operation (Audit Trail)</b>
44	Legal for Trade, Handbook 44 (NIST) (Audit Trail, Audit counters shown)
445	Legal for Trade Switch mode, Handbook 44 (NIST) and Measurement Canada compliant. (Front Panel Cal Access feature disabled, Cal Switch entry only, Audit counters hidden)
PH	Peak and hold stable or non stable weight. (Press Zero to clear Peak wt.)
PHt	Peak and hold for 2 seconds, stable or non-stable weight.
PH5	Peak and hold only stable weight.
PSt	Peak and hold for 2 seconds, only stable weight.
bd	Blank weight display.
ALt	Alarm Countdown timer. After the Alarm Countdown timer reaches 0, the Late timer starts. Use with A.P.4 or A.P.5 and Prod Id push button menu parameter set to on. Use with QC Weigh software.

### Battery Operation

bALt	<b>Alarm countdown</b> <b>Selects the Alarm countdown time, value in seconds.</b> <b>Stored in product array.</b>
on	Battery is present
off	No Battery

### Unit On Timer (bALt = on only)

tdy	<b>Selects the time value that the unit will remain on while the scale is not in use.</b>
on	Unit will remain on, On timer is off
0.5	<b>30 second On timer</b>
1	1 minute On timer
1.5	1.5 minutes On timer
2	2 minutes On timer
3	3 minutes On timer
5	5 minutes On timer
10	10 minutes On timer
30	30 minutes On timer
1hr	1 hour On timer
2hr	2 hour On timer
4hr	4 hour On timer
8hr	8 hour On timer

### Threshold Level Menu

ᄃᄃᄃ	<b>Threshold Level Entry</b> Selects a percent threshold of Capacity when AP2 and latching setpoint operation is active.
0.1 - 9.9	+0.1% to +9.9% of capacity. <b>Default setting is 1%</b>

### Default all Scale Parameter settings

ᄃᄃᄃᄃ	<b>Default Calibration and Parameter settings.</b>	
n	<b>Do not default settings.</b>	
ᄃ	1 <sup>st</sup> yes answer, Default all Calibration and Parameter settings.	
	ᄃᄃᄃᄃ	<b>Default Calibration and Parameter settings.</b>
	n	<b>Do not default settings.</b>
	ᄃ	Verify 2 <sup>nd</sup> yes answer, Default all Parameter settings.
	ᄃ	Verify 2 <sup>nd</sup> yes answer, Default all Calibration and Parameter settings.

### Test Mode Menu

XXXXXX	<b>Displays the raw counts from Analog to Digital converter. Press the Zero button to enter Test mode menu</b>	
4nnA	Set 4-20mA output to 4mA. Press ZERO to change the output level.	
	4ᄃ XX	Press the ZERO and PRINT pushbuttons to adjust 4mA level and UNITS pushbutton to exit. (default value = 97)
20nnA	Set 4-20mA output to 20mA. Press ZERO to change the output level.	
	20ᄃ XX	Press ZERO and PRINT pushbutton to adjust 20mA level and UNITS pushbutton to exit. (default value = 3C)

### Calibration and Parameter Menu Exit

ᄃᄃᄃᄃ	<b>Exit Calibration and Parameter Menu.</b>
n	<b>Do not exit menu roll over to the start of the parameter list.</b>
ᄃ	Exit Calibration and Parameter menu. Save all parameter changes. The scale will return to normal weighing when UNITS is pressed.

# Data Communications

## Standard Print String Formats

The Scale provides eight predefined print strings that are outputted when a manual print, auto print or print function is executed. The exact contents of the predefined print strings and custom data string configuration is shown below.

	Print String	Description
F0	<p>Standard Output Format, Prints current weight and units.</p> <p>&lt;STX&gt;&lt;p&gt;&lt;xxxx.xx&gt;&lt;SP&gt;&lt;uu&gt;&lt;SP&gt;&lt;MOT&gt;&lt;CR&gt;&lt;LF&gt;</p> <p>Sample Print String ±--10.05-lb</p> <p>Sample Pounds – Ounces String ±27lb-12.2-oz</p> <p>Note: “-” represents a space</p>	<p>&lt;STX&gt; Start of Text (02h)</p> <p>&lt;p&gt; Weight Polarity Negative weight printed as “-”, positive weight is printed as a space (20h).</p> <p>&lt;xxxx.xx&gt; Weight Data fixed field of 6 digits plus decimal. In overload, or underload “-----” is printed. Leading zeros are printed as spaces (20h).</p> <p>&lt;uu&gt; Displayed Units “lb”, “kg”, “oz”, “g”</p> <p>&lt;MOT&gt; (Available only in Continuous print mode , non-LFT) Motion Status Appends “MOT” to the print string when printing while in motion.</p> <p>&lt;SP&gt; Line Space (20h)</p> <p>&lt;CR&gt; Carriage Return (0dh)</p> <p>&lt;LF&gt; Line Feed (0Ah)</p>

<p>F :</p>	<p>Format 1, Prints current weight and the highest setpoint number that is active (Grading number).</p> <p>&lt;STX&gt;&lt;p&gt;&lt;xxxx.xx&gt;&lt;SP&gt;&lt;uu&gt;&lt;SP&gt; &lt;CWS&gt;&lt;MOT&gt;&lt;CR&gt;&lt;LF&gt;</p> <p>Sample Print String ±--10.05-lb-0</p> <p>Note: "-" represents a space</p>	<p>&lt;STX&gt; Start of Text (02h) &lt;p&gt; Weight Polarity Negative weight printed as "-", positive weight is printed as a space (20h). &lt;xxxx.xx&gt; Weight Data fixed field of 6 digits plus decimal. In overload, or underload "-----" is printed. Leading zeros are printed as spaces (20h). &lt;uu&gt; Displayed Units "lb", "kg", "oz", "g" &lt;MOT&gt; (Available only in Continuous print mode , non-LFT) Motion Status Appends "MOT" to the print string when printing while in motion. &lt;SP&gt; Line Space (20h) &lt;CR&gt; Carriage Return (0dh) &lt;LF&gt; Line Feed (0Ah) &lt;CWS&gt; Setpoint status (highest setpoint only). "0", "1", "2", "3", "4", "5", "6", "7", "8" Or "LOW", "UNDER", "ACCEPT", "OVER" and "HIGH".</p>
------------	--	---

<p>d3</p>	<p>Live Scale (Virtual) Display format, Prints current weight, units, annunciators, checkweigh status, and output status.</p> <p>&lt;"^"&gt;&lt;p&gt;&lt;xxxx.xx&gt;&lt;ut&gt;&lt;an&gt;&lt;chk1-4&gt;&lt;chk5-8&gt;&lt;out1-4&gt;&lt;out5-8&gt;&lt;ETX&gt;</p> <p>Sample Print String ±--10.05000000</p> <p>Note: "-" represents a space</p>	<p>&lt;"^"&gt; caret (5Eh)</p> <p>&lt;p&gt; Weight Polarity Negative weight printed as "-", positive weight is printed as a space (20h).</p> <p>&lt;xxxx.xx&gt; Weight Data fixed field of 6 digits plus decimal. In overload, or underload "-----" is printed. Leading zeros are printed as spaces (20h).</p> <p>&lt;ut&gt; Displayed Units lb = 0(30h), kg = 1(31h), oz = 2(32h), g = 3(33h), lb:oz = 4(34h)</p> <p>&lt;an&gt; Annunciators all off = 0(30h), all on = ?(37h) ZERO = bit 0 BATT = bit 1 MOT = bit 2</p> <p>&lt;chk1-4&gt; Setpoint status 1-4. all off = 0(30h), all on = ?(3fh) Setpt 1 = bit 0 Setpt 2 = bit 1 Setpt 3 = bit 2 Setpt 4 = bit 3</p> <p>&lt;chk5-8&gt; Setpoint status 5-8. all off = 0(30h), all on = ?(3fh) Setpt 5 = bit 0 Setpt 6 = bit 1 Setpt 7 = bit 2 Setpt 8 = bit 3</p> <p>&lt;out1-4&gt; Output status 1-4 all off = 0(30h), all on = ?(3fh) out 1 = bit 0 out 2 = bit 1 out 3 = bit 2 out 4 = bit 3</p> <p>&lt;out5-8&gt; Output status 5-8 all off = 0(30h), all on = ?(3fh) out 5 = bit 0 out 6 = bit 1 out 7 = bit 2 out 8 = bit 3</p> <p>&lt;ETX&gt; End of Text (03h)</p>
-----------	---	--

Lb1	<p>Custom Data String 1 (FR"L1"i?w\l\W\IP1\rN\r)</p> <p>Prints current weight, units, and GS/NT.</p>	<p>1</p> <p>Default print string for a Doran Model LR350 Barcode Label Printer.</p>
Lb2	<p>Custom Data String 2 (FR"L2"i?w\l\m\W\l\DF\l0\l\c\lM\lY\lTc\lTP\IP1\rN\r)</p> <p>Prints current weight, units, motion status, GS/NT, tare, net weight, product description, accumulator, counter, date, time.</p>	<p>Default print string for a Doran Model LR350 Barcode Label Printer.</p>
Lb3	<p>Custom Data String 3 (FR"L3"i?l0\lq\l\l\lM\lY\lTc\lTP\IP1\rN\r)</p> <p>Prints gross weight, tare, net weight, date, time.</p>	<p>Default print string for a Doran Model LR350 Barcode Label Printer.</p>
Lb4	<p>Custom Data String 4 (FR"L4"i?l\l\l\c\lB\IP1\rN\r)</p> <p>Prints Accumulator weight, units, counter value. Clears Accumulator and Counter values.</p> <p>Accumulator recall print feature.</p>	<p>Default print string for a Doran Model LR350 Barcode Label Printer.</p>

## **Custom Data String Configuration**

Programming the custom data strings requires the use of Doran's Dimension Windows program or a terminal program and a data communications option. The custom data strings can be configured from serial port 1, port 2 or any communications option.

To download a custom data string, the string must be prefaced by a command to tell the indicator to expect a custom print string.

ELx<string>↵           Enter (download to indicator) custom data string  
RLx↵                    Read (upload from indicator) custom data string

x is the custom data string number (1 to 4)

↵ is a Carriage Return (enter key in terminal program)

The custom data string is limited to a 250-character length. A control character counts as two characters. For instance, The following string is 8 characters in length "\w\u\r\n". The custom string is terminated and downloaded by pressing the enter (↵) key. To program this string into the custom data string 1 location, send the following string to the indicator:  
EL1\w\u\r\n↵

To configure the custom data string with a terminal program, simply type the data string commands into the terminal and press enter. Plain text can be inserted into the custom data string by typing it in. No slash or control character is necessary.

Once programmed, set the Output Format For parameter to **1b1** to activate the custom data string.

Note: If the PRINT button is pressed while the accumulator or counter is displayed, custom data string 4 is transmitted instead of the configured serial output string option for the Output Format.

## Custom Data String Control Characters

\a	Accumulated Weight (polarity = <sp>), 8 digits with leading spaces, and decimal point)
\A	Accumulated Weight (polarity = "0"), 8 digits with leading zeros, and decimal point)
\b	Dumps print buffer memory, clears buffer
\B	Clears Accumulator & Counter
\BS	Battery status, Low = "batt" or Good = "BATT"
\c	Accumulation Counter (7 digits, leading spaces)
\C	Accumulation Counter (7 digits, leading zeros)
\d	Current Weight (no polarity, no decimal point, 6 digits with leading zeros)
\D0	Current Product Description (20 characters thru serial port)
\DF	Current Product Description (fixed 20 characters including leading spaces)
\E0	Current Preact Weight (polarity (<sp> or "-"), 6 digits, and decimal point)
\Ex	Preact Weight (x = 1-8, Preact field location)(polarity (<sp> or "-"), 6 digits, and decimal point)
\e	Check sum value
\fVx	Data field, variable length up to 64 characters, x = 1-8 field number
\fFx	Data field, fixed 20 characters including leading spaces, x = 1-8 field number
\q	Current Gross weight (polarity (<sp> or "-"), 6 digits, and decimal point)
\n	Current Net weight (polarity (<sp> or "-"), 6 digits, and decimal point)
\p	Gross Weight in pounds (polarity (<sp> or "-"), 6 digits, and decimal point)
\k	Gross Weight in kilograms (polarity (<sp> or "-"), 6 digits, and decimal point)
\g	Gross Weight in grams (polarity (<sp> or "-"), 6 digits, and decimal point)
\o	Gross Weight in ounces (polarity (<sp> or "-"), 6 digits, and decimal point)
\z	Gross Weight in lb-oz (polarity (<sp> or "-"), 6 digits, and decimal point)
\P	Net Weight in pounds (polarity (<sp> or "-"), 6 digits, and decimal point)
\K	Net Weight in kilograms (polarity (<sp> or "-"), 6 digits, and decimal point)
\G	Net Weight in grams (polarity (<sp> or "-"), 6 digits, and decimal point)
\O	Net Weight in ounces (polarity (<sp> or "-"), 6 digits, and decimal point)
\L	Net Weight in lb-oz (polarity (<sp> or "-"), 6 digits, and decimal point)
\m	Motion Status – shown in continuous print only ("MOT" or <SP><SP><SP> )
\hxx	Hex command two digits (xx = hex #)
\H	Current Batch number (6 digits with leading zeroes, multi-batch mode)
\I0	Current Product ID (6 digits front panel or 20 characters thru serial port) (one product mode)
\I0	Current Product ID (6 numeric digits) (250 products mode)
\Ix	Product ID (x = 1-8, ID field location)(6 digits front panel or 20 characters thru serial port or barcode entry) (one product mode)
\IF0	Current Product ID (fixed 20 characters including leading spaces)
\IFx	Product ID (x = 1-8, ID field location)(fixed 20 characters including leading spaces)(one product mode)
\s	Check weight status ("HIGH ", "OVER ", "ACCEPT", "UNDER ", "LOW ", and " " is check limit off)
\S0	Current Setpoint Weight (polarity (<sp> or "-"), 6 digits, and decimal point)
\Sx	Setpoint Weight where desired setpoint x = 1-8, L = Low, U = Under, O = Over,



	H = High (polarity (<sp> or "-"), 6 digits, and decimal point)
\SN	Current sample number, fixed 6 digits.
\t	Current Tare weight (polarity (<sp> or "-"), 6 digits, and decimal point)
\TM	Time (Military) HH:MM (HH = 00-23)(MM = 00-59)
\Tm	Time (Military) HH:MM:SS (HH = 00-23)(MM = 00-59)(SS = 00-59)
\TC	Time (Civilian) HH:MM "AM"/"PM" (HH = 01-12)(MM = 00-59)
\Tc	Time (Civilian) HH:MM:SS "AM"/"PM"(HH = 01-12)(MM = 00-59)(SS = 00-59)
\TP	Time "AM" or "PM"
\M	Month (01-12)
\Y	Year (00-99)
\J	Day (01-31)
\x	Start of Text (02 hex)
\l	Print "\
\u	Current Units ("lb", "kg", "oz", "g")
\Ux	Prints other custom data string. (x = 1-4, data string number. Note: command will not print same custom data string)
\V	Late timer value string command, in seconds fixed 6 digits.
\r	Carriage Return (0d hex)
\l	Line Feed (0a hex)
\w	Current Weight, leading spaces (polarity (<sp> or "-"), 6 digits & decimal point)
\w0	Current Weight, leading zeros (polarity ("0" or "-"), 6 digits & decimal point)
\wp	Current Weight, leading spaces, no polarity (6 digits & decimal point)
\wP	Current Weight, leading zeros, no polarity (6 digits & decimal point)
\W	Current weighing mode either "GS" or "NT".
\Q	Issues a push button print command on other port.
\R	Clears Tare and sets scale to Gross mode
\XF	User ID, fixed 20 characters including leading spaces.
\XV	User ID, variable length up to 20 characters.
\y	Current Weight polarity (<sp> or "-")
\y0	Current Weight polarity ("0" or "-")
\Z	Zero scale (same as pressing zero pb)

## **Remote Setpoint / Preact / Limit Entry and Recall**

To download a setpoint or preact weight value, the serial string must be prefaced by a command to tell the indicator to expect a setpoint weight value.

ESx<weight>↵	Enter (download to indicator) Setpoint Weight value
RSx↵	Read (upload from indicator) Setpoint Weight value
EPx<weight>↵	Enter (download to indicator) Preact Weight value
RPx↵	Read (upload to indicator) Preact Weight value

x is the setpoint / preact number or limit only (1 to 8, or 0 for current number, l = low, u = under, o = over, h = high )

↵ is a Carriage Return (enter key in terminal program)

<weight> contains polarity (negative only), up to 6 digits, and a decimal point

When entering a negative value, do not place a space between the negative sign and the weight value. A positive value is assumed without the negative polarity sign present. The decimal point location and resolution for the weight being entered must match the scale's current settings.

To indicate that the setpoint value has been successfully saved, 585E8 will momentarily be displayed. An entry error will be indicated by a “?” character transmitted via the communication option.

For example:

To enter a weight value of 20 lb for setpoint 7, send the following string: ES720.000↵.

To enter a -1 lb value for setpoint 5, send the following string: ES5-1.000↵.

## **Remote Product ID Entry and Recall:**

To download an ID value, the string must be prefaced by a command to tell the indicator to expect an ID value. Note: Entering any serial string that begins with a numeric character does not require a prefaced command to be saved as a value for ID 1.

EIx<ID>↵	Enter (download to indicator) Product ID value
Rix↵	Read (upload from indicator) Product ID value

x is the ID location number (1 to 8, or 0 for current number)

↵ is a Carriage Return (enter key in terminal program)

<ID> is an alpha numeric string up to 20 characters in length

To indicate that the value has been successfully saved, 585E8 will momentarily be displayed. An entry error will be indicated by a “?” character transmitted via the communication option.

Note: non-numeric characters saved in Product ID memory cannot be viewed(Recall) by way of scale's front display.

For example:

To enter a value of 123456 for the ID 7, send the following string: ES7123456↵.

To enter in a "ABC600" value for ID 3, send the following string: ES3ABC600↵.

### **Remote Product Description Entry and Recall:**

To download a Product Description, the string must be prefaced by a command to tell the indicator to expect the serial string. With the `PRD` parameter set for `250`, the Product Description string will be stored in the same array field as the current Product ID. For the one product mode with a setting of `PRD` set to `1`, only one Product Description string can be stored.

ED<DATA>↵           Enter (download to indicator) Product Description.

RDx↵                 Read (upload from indicator) Product Description.

↵ is a Carriage Return (enter key in terminal program)

<DATA> is an alpha numeric string up to 20 characters in length

To indicate that the Description string has been successfully saved, `SAVED` will momentarily be displayed. An entry error will be indicated by a "?" character transmitted via the communication option.

### **Remote Tare Entry and Recall:**

To download a tare weight value, the serial string must be prefaced by a command to tell the indicator to expect a tare weight value. Note: When set for 250 product memory, the Tare value will be stored in the same array field as the current Product ID. A total of 250 Tare Values can be stored, one for each Product ID.

ET<tare>↵           Enter (download to indicator) Tare Weight value

RT↵                 Read (upload to indicator) Tare Weight value

↵ is a Carriage Return (enter key in terminal program)

<weight> contains up to 6 digits, and a decimal point

The tare weight must be a positive value. The decimal point location and resolution for the weight being entered must match the scale's current settings.

To indicate that the setpoint value has been successfully saved, `SAVED` will momentarily be displayed. An entry error will be indicated by a "?" character transmitted via the communication option.

Example:

To enter a value of 10 lbs. for the tare weight, send the following string: ET10.000↵.

To enter 1.5 lbs. for the tare weight, send the following string: ET1.500↵.

### **Remote Data Field Entry and Recall:**

To download a Data Field string, the string must be prefaced by a command to tell the indicator to expect a serial data string.

Efx<DATA>↵ Enter (download to indicator) Data Field string  
Rfx↵ Read (upload from indicator) Data Field string

x is the Data Field number (1 to 8)  
↵ is a Carriage Return (enter key in terminal program)  
<DATA> is an ascii string up to 63 characters in length.

To indicate that the value has been successfully saved, **SAVED** will momentarily be displayed. An entry error will be indicated by a “?” character transmitted via the communication option.

Note: non-numeric characters saved in Data Field memory cannot be viewed(Recall) by way of scale's front display.

For example:

To enter a value of 987654 for the Data Field 6, send the following string: Ef6987654↵.

To enter in a "NEW#20" value for Data Field 4, send the following string: Ef4NEW#20↵.

### **Data Print Buffer**

To enable serial data buffering of Port 1. The Serial Data Output Handshaking Parameter “**SDO**” must be set to one of the following options “**BUF**”. The maximum number of bytes that can be stored is 65,024 bytes. Buffer Low warning starts at 62,976 bytes and the Buffer Full warning occurs at 65,024 bytes. Print Buffer will stop accepting data after the Full warning is shown. All weighments made after the Full warning will be lost.

Maximum number of print requests = (Print buffer size) / (number of characters in a print string)

Example: Calculate number of print requests that can be stored into print buffer.

F0 print format: 18 bytes = <STX><p><xxxx.xx><SP><uu><SP><MOT><CR><LF>

65,024 / 18 = 3612 print requests that can be stored.

There are two methods to access the data stored in the print buffer memory. One is using serial commands “d”, “D”, or “CB”. The other is to use the Communications Menu to select a Print Buffer function. To enter the Communications menu, press and hold PRINT push button for 3 seconds. Use the UNITS button to scroll through the menu parameters.

Use ZERO push button to select a function. Press ENTER push button to save and exit. Press CLEAR to exit without saving current menu selection.

The Communications menu's print buffer options/functions:

- Turn On the print buffer, set the Handshaking parameter to `HS BUF`.
- Turn Off the print buffer, set the Handshaking parameter to `HS SF`.
- Dump data stored in print buffer to serial port 1, select `BUF DP`.
- Dump & clear data stored in print buffer, select `BUF DL`.
- Clear data stored in print buffer, select `BUF CL`.

Total transmission time for the print buffer to dump 65,000 bytes of data is: 1:15 @ 9600 baud or 0:26 @ 38.4K baud. Display will show DUMP message while the print buffer is transmitting data through serial port 1.

Command (RXD)	Scale output Response (TXD)	Description
W↵ or w↵	Will respond with current selected data string transmitted from serial port 1. (No transmission will occur if scale is in motion.)	Transmits data out TXD1 (Port1)
Wx↵ or wx↵	Will respond with Custom Data String transmitted from serial port 1.	Transmits Custom Data String number x = 1 to 4 out TXD1 (Port1) Transmits Data Output Format 1 x = 0 out TXD1 (Port1)
P↵ or p↵	Will respond with current selected data string transmitted from serial port 2. (No transmission will occur if scale is in motion.)  If this command is sent from serial port 1, a "*" will be sent out of port 1 to acknowledge the command was executed.	Transmits data out TXD2 (Port2)
Px↵ or px↵	Will respond with Custom Data String transmitted from serial port 2.  If this command is sent from serial port 1, a "*" will be sent out of port 1 to acknowledge the command was executed.	Transmits Custom Data String number x = 1 to 4 out TXD2 (Port2) Transmits Data Output Format 2 x = 0 out TXD2 (Port2)
U↵ or u↵	* (acknowledgment, port 1 only)	Scale changes current units
Z↵	* (acknowledgment, port 1 only)	Zeros scale
T↵ or t↵	* (acknowledgment, port 1 only)	Tares Scale and enters Net mode
G↵ or g↵	* (acknowledgment, port 1 only)	Scale enters Gross mode
N↵ or n↵	* (acknowledgment, port 1 only)	Scale enters Net mode
d↵	Print Buffer data. Display shows DUMP message while transmitting.	Dumps serial data that is stored in Print Buffer. Active when Serial Handshaking is set for Buffer, 485 or Bluetooth Buffer mode.
D↵	Print Buffer data & clears buffer. Display shows DUMP message while transmitting.	Dumps & clear serial data that is stored in Print Buffer. Active when Serial Handshaking is set for Buffer, 485 or Bluetooth Buffer mode.
CB↵	Clears Buffer data.	Clear serial data that is stored in Print Buffer. Active when Serial Handshaking is set for Buffer, 485 or Bluetooth Buffer mode.
ELx↵	* (acknowledgment, port 1 only)	Enter data into Custom Data String number x = 1 to 4 See Custom Data String Configuration
RLx↵	Label buffer string	Read data in Custom Data String number x = 1 to 4 See Custom Data String Configuration

RSx.↓	Setpoint or Check limit weight value.	Read weight value in Setpoint number x = 1 to 8, 0 = current Setpoint number x = L(Low), U(Under), O(Over), H(High). See Remote Setpoint Entry and Recall.
ESx.↓	* (acknowledgment, port 1 only) Display will show "✓" to indicate that the Setpoint or Check Limit value has been successfully saved to non-volatile memory	Enter weight value in Setpoint number x = 1 to 8, 0 = current Setpoint number x = L(Low), U(Under), O(Over), H(High). See Remote Setpoint Entry and Recall.
RPx.↓	Preact weight value.	Read weight value in Preact number x = 1 to 8, 0 = current Preact number See Remote Preact Entry and Recall.
EPx.↓	* (acknowledgment, port 1 only) Display will show "✓" to indicate that the Preact value has been successfully saved to non-volatile memory.	Enter weight value in Preact number x = 1 to 8, 0 = current Preact number See Remote Preact Entry and Recall.
RIx.↓	Product ID.	Read value in Product ID number x = 1 to 8, 0 = current ID number See Remote Product ID Entry and Recall.
RI0.↓	Product ID number.	Request the currently active Product ID number. See Remote Product ID Entry and Recall.
EIx.↓	* (acknowledgment, port 1 only) Display will show "✓" to indicate that the Product ID has been successfully saved to non-volatile memory .	Enter characters in Product ID number x = 1 to 8., 0 = current Product ID number. Maximum of 20 characters can be entered. See Remote Product ID Entry and Recall.
RNx.↓ (250 product)	* (acknowledgment, port 1 only) Product ID number.	Select an existing Product ID Number for current active product. x = 0 to 999999, ID number. See Remote Product ID Number Entry and Recall.
ENx.↓ (250 product)	* (acknowledgment, port 1 only) Product ID number.	Create a new Product ID Number for current active product. x = 0 to 999999, ID number. See Remote Product ID Number Entry and Recall.
RD.↓	Product Description.	Read Product Description field. See Remote Product Description Entry and Recall.
ED.↓	* (acknowledgment, port 1 only) Display will show "✓" to indicate that the Product Description has been successfully saved to non-volatile memory.	Enter characters in Product Description. Maximum of 20 characters can be entered. See Remote Product Description Entry and Recall.
RT.↓	Tare weight value.	Read Tare weight value. See Remote Tare Entry and Recall.
ET.↓	* (acknowledgment, port 1 only) Display will show "✓" to indicate that the Tare value has been successfully	Enter Tare weight value. See Remote Tare Entry and Recall.

	saved to non-volatile memory.	
A↓	Accumulate stable weight value. Display will show "Ⓐ" to indicate that the Accumulation has occurred.	Adds current stable weight value to Accumulator, Counter is incremented.
RA↓	Accumulator weight value.	Read Accumulator weight value.
RC↓	Counter value.	Read Counter value.
CA↓	* (acknowledgment, port 1 only) Display will show "ⒸⒶ" to indicate that the Accumulator & Counter values have been cleared	Clears Accumulator & Counter values.
BS↓	* (acknowledgment, port 1 only) Display will show "ⒷⓈ" to indicate that the Batch program has started.	When in the Batch mode, Scale will run the batch program.
BX↓	* (acknowledgment, port 1 only) Display will show "Ⓑ×" to indicate that the Batch program has stopped.	When in the Batch mode, Scale will stop the batch program and jump to line 1. All batch relay outputs inactive.
BP↓	* (acknowledgment, port 1 only) Display will show "ⒷⓅ" to indicate that the Batch program has paused.	When in the Batch mode, Scale will pause at current step in the batch program. All batch relay outputs inactive.
ROx↓	Read Output Terminal (TB4) Status, Respond with ASCII (30h) 0 = non-active or ASCII (31h) 1 = active	Reads status of Output number x = 1 to 8.
EOxy↓	* (acknowledgment, port 1 only) Successfully saved to Output Terminal (TB4).	Enter value for Output number x = 1 to 8. Non-active y = 0 ASCII (30h) or Active y = 1 ASCII (31h).
RB↓	Will respond with stored bluetooth module's address.	Request the 12 digit stored bluetooth address (ASCII, leading zeros).
Efx↓	Enter Data Field, * (acknowledgment, port 1 only)	Enter characters in Data Field number x = 1 to 8. Maximum of 63 characters can be entered. See Data Field Entry and Recall.
Rfx↓	Read Data Field, * (acknowledgment, port 1 only)	Reads characters in Data Field number x = 1 to 8. See Data Field Entry and Recall.
RU↓	Read User ID.	Reads current User ID value.
EU↓	Enters User ID for login. * (acknowledgment of login, port 1 only) ! (login does not match stored IDs, port 1 only)	Enters User ID value for login. Value is compared with existing User ID values stored in memory. See QC Weigh software section.

**Table 2: Doran serial protocol**



# Installation Instructions

## Removing the Rear Panel

Place the indicator on a flat work surface with the front facing down. Using a 5/16 inch socket, remove all cover screws and flat metallic washers. Save screws and washers for later installation. The rear panel is now loose can be lifted from the main enclosure.

Rear panel installation: Place the rear cover on the main enclosure. Install all screws and flat metallic washers. Tighten screws to 15 in-lb

### **WARNING**



**Take care not to damage any external or internal parts when removing and replacing the rear panel.**

### **WARNING**



**Replace gasket if it shows wear or damage.**

## Cable Glands

Instructions for loosening cable glands (only those with metal stopper plugs), removing metal stopper plugs, reinserting metal stopper plugs, and re-tightening cable glands:

### **WARNING**



**Take care not to damage any external or internal parts when removing and replacing the metal stopper plugs.**

Agro cable gland: 6.35 mm Stainless Steel (SS) plug removal and replacement. Tilt indicator towards its back so that the SS plug does not fall into the indicator when loosening and tightening the cord grip. Loosen and remove the cord grip cap and allow the SS plug to slide out. If the SS plug does not slide out, grip it with pliers and pull it out. Insert the SS plug into the cord grip and reattached the cap. Tighten the cap making sure the SS plug protrudes 0.050 inches - 0.150 inches. Tighten until the rubber insert begins to protrude or to a maximum torque of 5 Nm.

### **WARNING**



**Before installing field wiring to any devices in this system, disconnect any power sources. To prevent ignition hazards, take special care not to touch or accidentally damage any internal parts of Model 8100IS/8200IS Indicator/Remote Display, as this may impair intrinsic safety.**

## Internal Power Connections

External Power Connections (J6)	
DC Input	Color
-	Brown
+	Blue

## Load Cell Connections

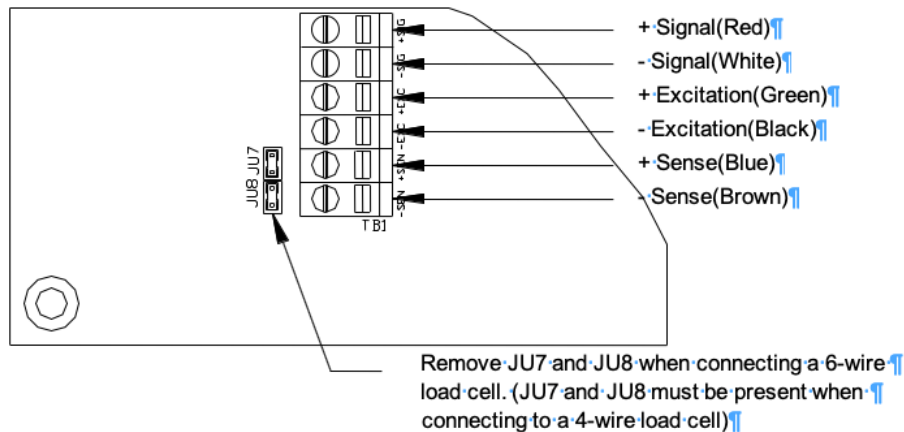

Load Cell (TB1)		
Pin #	Function	Wire Color
1	+ Load Cell Signal	Red
2	- Load Cell Signal	White
3	+ Load Cell Excitation	Green
4	- Load Cell Excitation	Black
5	+ Sense Signal	Blue
6	- Sense Signal	Brown

4 or 6 Wire Load Cell Jumper Settings	
JU7	In for 4 wire Out for 6 wire load cell connections
JU8	In for 4 wire Out for 6 wire load cell connections

Load cell connections are made through terminal block “TB1” located at the bottom center of the main board. The power cord connects to terminal block “J1” adjacent to the transformer.

These connections are accessible by removing the rear cover. Connect the load cell wires by inserting the tip of a flathead screwdriver into the rectangular hole located on the top of terminal block TB1. Use the screwdriver blade to open the adjacent slot. Insert the stripped end of a single load cell wire into the round cage opening. Be sure that the wire insulation is outside the terminal block cage to ensure a proper connection. Once the

wire end has been inserted, remove the screwdriver. The wire will now be captured in the terminal slot.

When installing load cell wire connections, be sure to check the JU7 and JU8 jumper configuration. Remove JU7 and JU8 for a six-wire load cell or be sure JU7 and JU8 are in place for a four-wire load cell. Load cells must be certified for appropriate hazardous area and entity parameters. See note one on control drawing 900243

Uo 7.14 V, Io 0.7076 A, Po 0.895 W, Co 10.8 uF, Lo 71 uH

### **Scale Installation**

Scale installation involves locating the weighing element(s) in the hazardous area and mounting the 8200IS Intrinsically Safe Indicator in a secure location, which may (or may not) be located in the hazardous area. Power for the 8200IS Indicator can be provided by either the Model 8BIS rechargeable battery or the Model 8AIS AC/DC Power Supply. The Model 8AIS AC/DC Power Supply provides a permanent power source while the 8BIS rechargeable battery must be removed from the hazardous area for charging. Only one power source can be used at a time.

The AC power supply for the 8AIS AC/DC Power Supply must be installed in conduit (or other cabling method approved by the National Electrical Code) with the appropriate junction boxes and seals for the hazardous location. The use of conduit for the power supply output, interface output and the load cell cables is not required. The use of conduit for these cables is a decision left to the Plant Safety Engineer and local building codes. All seals and accessories required to make the proper installation and maintain the separation of the hazardous and safe areas are the responsibility of the customer.

It is recommended that any cable runs that are part of the Intrinsically Safe circuit be marked with a bright blue tape. Blue cable may also be utilized.

All Intrinsically Safe wiring should be located more than 2 inches from Non-Intrinsically Safe wiring, unless separated by an insulating or ground partition. A 0.1 inch spacing must be maintained between intrinsically safe circuits.

All installation and / or maintenance should be coordinated with the plant engineer or the responsible personnel.

#### **CAUTION**



**Although the Indicator is approved for use in hazardous locations, caution should always be observed in all areas designated as hazardous including the use of tools and equipment.**

#### **CAUTION**



**If there are any doubts concerning the classification of hazardous areas, the suitability of equipment for a hazardous location, or any questions about the installation, consult the Plant Engineer or personnel responsible for the installation.**

## WARNING



The display and key board area are considered to constitute an electrostatic discharge hazard. Clean only with a damp cloth.

The scale should be securely mounted using the supplied mounting bracket to a table, wall or under a cabinet to prevent the scale indicator from being accidentally dropped or damaged. The indicator should be mounted for easy removal of the battery pack for recharging purposes.

### **Electrical Ratings**

See Control Drawing No. 900243 for inter-device connections and intrinsic safety entity parameters.

Model 8AIS:

Input: Normal Operation 115 Vac, 0.125 A; Um = 120 V, AC only

Output: See Control Drawing No. 900243.

Model 8BIS:

Input: See Control Drawing No. 900243.

Output: See Control Drawing No. 900243.

Model 8CHG:

Input: Normal Operation 120 Vac, 50-60 Hz, 0.125 A; Um = 120 V, AC only

Output: 7.8 Vdc, 0.125 A; See Control Drawing No. 900243.

Model 8FB:

Input: 6-12 V dc, 2.0 A or less.

Output: SELV/low voltage limited energy.

Model 8100IS/8200IS Indicator/Remote Display:

Input: See Control Drawing No. 900243.

Output: See Control Drawing No. 900243.

Model 8JBX:

Input: See Control Drawing No. 900243.

Output: See Control Drawing No. 900243.

# Installation with the 8BIS Battery

The 8200IS Intrinsically Safe Weight Indicating System can be installed in hazardous locations using the 8BIS rechargeable battery. Battery operation permits the system to be used in locations where AC power is prohibited or is unavailable. When installing the system, it should be installed as a complete unit with the battery, indicator, weighing elements and options. Once the system is installed per the Control Drawing and the electrical circuit has been determined to be Intrinsically Safe, then the complete assembly with the options can be considered Intrinsically Safe.

The 8200IS Intrinsically Safe Weight Indicating System can be ordered as a complete system including a pre-installed weighing platform, 8200IS Indicator, Model 8BIS battery pack and Model 8CHG battery charger. The system can also be ordered without the weighing platform, which must be provided by the customer.

## **Battery Installation**

The electronics located in the Model 8BIS battery pack forms an intrinsically safe system when one Indicator/Remote Display Models 8100IS/8200IS is connected to its intrinsically safe output cable as shown above, and the Indicator/Remote Display Models 8100IS/8200IS are suitable for use in hazardous areas as shown on this Control Drawing No. 900243. No other devices are suitable for direct connection to the intrinsically safe output cable of Model 8BIS, and the only additional devices/configurations that may be connected to the Indicator/Remote Display Models 810IS/820IS are shown on Control Drawing No. 900243.

The output current of the Model 8BIS is limited by a resistor such that the output voltage-current plot is a straight line drawn between open-circuit voltage and short-circuit current.

The 8200IS Intrinsically Safe Indicator, Model 8BIS and the platform are approved for use in the hazardous area per the Control Drawing. The Battery pack must be removed from the hazardous area and taken into the safe area to be recharged. The Battery pack must be charged with the Model 8CHG Battery Charger. The Model 8CHG battery charger MUST be located in the Safe area and is NOT approved for hazardous areas.

### **CAUTION**



**The Model 8CHG battery charger must be located in the Safe area and is NOT approved for hazardous areas**

### **WARNING**



**There are no field serviceable parts in the 8BIS battery pack or 8CHG Charger. The power supply must be returned to Doran Scales, Inc. for service if a failure occurs.**

## **Battery Pack Operation**

The external intrinsically safe battery pack is located under the 8200IS indicator. The battery pack supplies power to the indicator through a cable with a military style connector. To remove the battery pack, power down indicator then disconnect the battery power supply cable from the rear of the 8200IS indicator by unscrewing the connector. Then loosen the two small black knobs and remove the battery pack by pulling up and outward on the battery pack handle. Do not remove the battery pack without first removing the battery power cable from the 8200IS rear panel. If any damage occurs to the connector or power cable, discontinue use immediately and contact Doran's Technical Support Department.

When the 8200IS indicates low battery, the indicator will cease to function in approximately two hours. When the low battery warning appears, the battery should be recharged as soon as possible. The battery pack must be removed from the hazardous area for charging. Recharge time is typically 30 hours. Only the 8CIS battery charger can be used to charge the 8BIS battery pack. Do not use the 8CIS battery charger to charge any other batteries.

The 8CHG battery charger has two indicators on the top of the charger unit. The Ready light will be on when the charger is plugged into 115VAC (220VAC optional). If the Ready light remains off, 115VAC is not present, the battery is shorted, or the charger has a blown fuse.

To charge the 8BIS battery pack, remove the battery from the hazardous area. Plug the charger into a wall outlet. When plugged in, the charger will display a green READY light. If the green light is not lit, plug the charger into another outlet. Connect the battery pack to the charger by aligning the keyed connector and screwing the connector firmly to the power cable power receptacle on the front of the charger box. Do not force the connector, this is a sign that the keyed connector is not properly aligned with the charger receptacle.

To place the battery back into service, reinstall the battery pack by first securing the battery pack into the indicator's u-bracket with the small black knobs. Then reconnect the battery pack to the indicator by aligning the keyed connector and screwing the connector firmly to the power cable power receptacle on the rear panel. Do not force the connector, this is a sign that the keyed connector is not properly aligned with the charger receptacle.

Once charged, the battery pack will last 8 hours in of continuous use or 40 hours in a typical application using the automatic shutoff timer (single 350  $\Omega$  load cell), after which the indicator will provide a low battery warning on the display. Multiple load cells, Fiber Optic or other options will reduce battery life. For multiple load cell applications, battery life is significantly reduced. For example, with a four, 350  $\Omega$  load cell configuration, the low battery indication will begin at about 4 to 6 hours of continuous use. After the low battery indication begins, the indicator will operate for a while before the indicator will shut off. Load cells with higher input impedance values will provide longer life as will systems with fewer load cells. To significantly extend the battery life, enable the Unit On Timer parameter which will power down the scale automatically after a period of non-use. The default setting shuts off the indicator after 30 seconds of non-use.

The battery pack should be able to support at least 1000 recharges before the end of the battery life is reached. This is an estimate as many factors can affect battery life like, severe temperature changes and charging before the 8200IS displays Low Battery.

An optional extra battery pack can be ordered for situations that require uninterrupted operation of the scale. The battery pack may be left plugged in the charger until ready to use.

# Installation with the 8AIS AC Power Supply

The Model 8AIS is an AC/DC power supply that can be used for more permanent installations or when regular power down situation is not desired. The power supply provides an intrinsically safe output and can be mounted in the hazardous areas provided the Control Drawing is followed. The power supply can also be mounted in the safe area with the output entering the hazardous area. The cable installation must comply with National Electrical Code requirements for hazardous location wiring. The power supply provides an intrinsically safe DC power source when properly installed.

The power supply supports 120VAC, 50/60 Hz operation. The 8AIS AC/DC Power Supply has been sealed and cannot be field serviced. The power supply has been designed to cease functioning under fault conditions such as shorted outputs, improper input voltage, excess current, etc. See Interconnect Extension Cable below for more information. The power supply must be returned to Doran Scales, Inc. for service if a failure occurs.

## WARNING



**There are no field serviceable parts in the 8AIS AC/DC Power Supply. The power supply must be returned to Doran Scales, Inc. for service if a failure occurs.**

## AC Power Supply Installation in Hazardous Location

The Model 8AIS can be installed within the hazardous area by following the proper guidelines outlined in the Control Drawing. An adapter cable, which connects the Intrinsically Safe Indicator to the AC/DC Power Supply, is provided when the AC/DC Power Supply is ordered. An extension interconnect cable can be assembled with parts provided with the AC/DC Power Supply (see Extension Cable below).

When only the included adapter cable is utilized, the power supply must be mounted within 1 meter of the 8200IS indicator. The Model 8AIS power supply and the indicator must be securely mounted. Prior to installation in a hazardous location, the plug on the power supply should be removed to permit the cord to be installed in rigid conduit. If a cord's strain relief is attached to the power supply, remove it from the female 1/2" conduit seal portion of the supply. Power to the Model 8AIS must be installed in 1/2" rigid conduit or The National Electrical Code approved alternate. The cord is then routed through the rigid conduit to a junction box approved for the area classification. The power connection is then completed in this junction box. When the conduit exits the hazardous area, it must be properly sealed in accordance with The National Electrical Code. Additional seals may be required at the junction box.

The electronics located in the barrier circuit of Model 8AIS forms an intrinsically safe system when one Indicator/Remote Display Models 8100IS/8200IS is connected to its intrinsically safe output cable as shown in the Control Drawing, and the Indicator/Remote Display Models 8100IS/8200IS are suitable for use in hazardous areas as shown on this Control Drawing No. 900243. No other devices are suitable for direct connection to the intrinsically safe output cable of Model 8AIS, and the only additional devices or



configurations that may be connected to the Indicator/Remote Display Models 8100IS/8200IS are shown on this Control Drawing No. 900243.

The output current of the Model 8AIS associated apparatus is limited by a resistor such that the output voltage-current plot is a straight line drawn between open-circuit voltage and short-circuit current.

Associated apparatus Model 8AIS is supplied with an enclosure suitable for the application in accordance with the National Electrical Code (ANSI/NFPA 70) for installation in the United States, the Canadian Electrical Code for installations in Canada, or other local codes, as applicable.

The associated apparatus Model 8AIS must be connected to a suitable ground electrode per the National Electrical Code (ANSI/NFPA 70), the Canadian Electrical Code or other local installation codes, as applicable. The resistance of the ground path must be less than 1 ohm.

Intrinsically safe circuits must be wired and separated in accordance with Article 504.20 of the National Electrical Code (ANSI/NFPA 70) or other local codes, as applicable.

This associated apparatus Model 8AIS has not been evaluated for use in combination with another associated apparatus.

### **AC Power Supply Installation In Safe Areas**

The Model 8AIS AC/DC Power Supply can be installed within the safe area by following the proper guidelines outlined in the Control Drawing. A short output cable, which connects the Intrinsically Safe Indicator to the AC/DC Power Supply, is included when the AC/DC Power Supply is ordered. An optional extension cable can be purchased (see Interconnect Extension Cable below). This extension cable may exit the hazardous area provided it is installed in accordance with the National Electrical Code rules for hazardous location cabling. The extension cable makes the connection to the AC/DC power supply within the safe area. The DC output of the power supply is considered Intrinsically Safe and should be treated as an intrinsically safe output from a barrier.

Once mounted in the safe area, the Model 8AIS can be connected to the proper power supply utilizing the supplied power cord.

### **Extension Cable**

The optional extension cable is used to extend the length of the power supply cable in situations that require a longer run of cable between the 8AIS AC/DC Power Supply and Intrinsically Safe Indicator. The maximum length is 7 meters.

Extension cable part numbers: WCB0234 – 3m long or WCB0235 – 6m long

**WARNING NON-WARRANTY DAMAGE TO THE POWER SUPPLY IS LIKELY IF THE OUTPUT IS CONNECTED TO A SHORTED OR LOW IMPEDANCE CIRCUIT. THE DC POWER CIRCUIT TO THE INDICATOR SHOULD BE CHECKED WITH AN OHMMETER BEFORE APPLYING POWER TO THE 8AIS POWER SUPPLY. A READING OF LESS THAN 1000Ωs**



**INDICATES A PROBLEM. DO NOT APPLY POWER UNTIL THE CAUSE OF THE LOW IMPEDANCE IS FOUND AND CORRECTED.**

### **Remote Switch Connections**

The remote switch terminal is found on the top of the main board. Remove the rear cover to access these connections. Connections are made by inserting each lead of the optional cable into the P2 terminal block. Connect Remote Switch between P2 terminal marked "SW1" and "GND" or "SW2" and "GND".

<b>P2 Option Connections</b>		
<b>Pin #</b>	<b>Function</b>	<b>Wire Color</b>
1	Ground	Black
2	Switch 1 Input	White
3	Switch 2 Input	White
4	Ground	Black

# Hazardous Area Fiber Optic Option

A Doran's Fiber Optic Option includes two channels for communication. Either of the options is installed in the hazardous area inside the enclosure. Fiber Optic communication is perfect for a hazardous location as it has no electrical potential, and does not create a hazard. Fiber Optic cable does not have to be run through conduit, saving much installation expense.

This option must be installed at Doran and should be ordered at time of the initial purchase. If this is not possible, the option can be installed at Doran by returning the unit to the factory for retrofit. Field installation of the fiber optic option board is not permitted by the Certifier's regulations. Installation of the fiber optic cabling is permitted. When ordering one of these options please know approximately how much cable is needed to reach the safe area. The maximum length available without the use of signal boosters is 1000 feet.

If you have purchased Doran's Fiber Optic Option and wish to communicate with a PC or printer in the safe area, you must also purchase Doran's 8FB fiber optic to RS-232 option. Third party conversion boxes will not operate with Doran's fiber optic option.

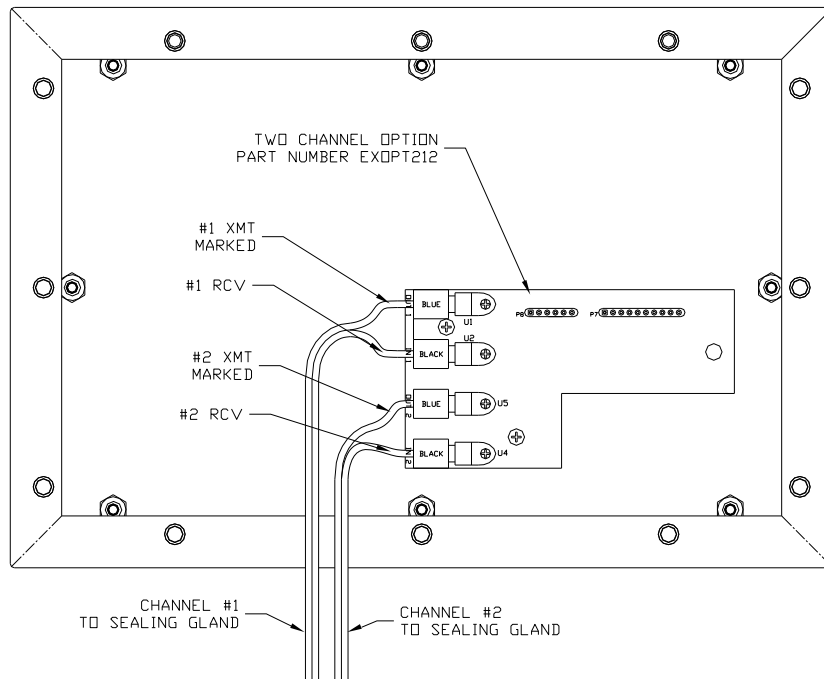
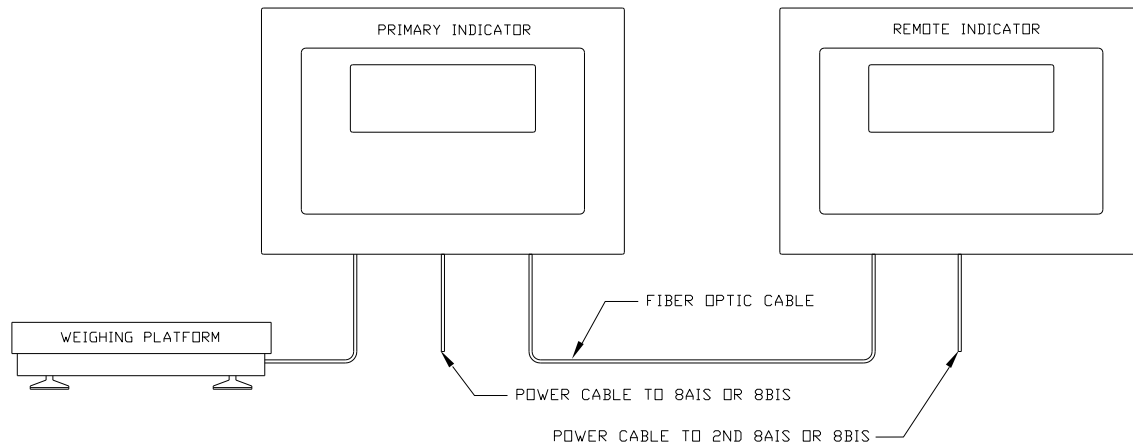

**Fig. 7: Hazardous Area Fiber Optic option**



# Remote Display Option

A second indicator can be connected through a fiber optic cable to the primary indicator. Each indicator must be connected to their own power source, either an 8AIS Power Supply or 8BIS Battery Pack. Both indicators must have the fiber optic option installed. The serial communication is through the connector at Channel 1 only. Fiber optic cabling will be included separately and must be installed per the Hazardous Area Fiber Optic Option instructions and control drawings.



**Fig. 11: Remote Display Option**

On the Primary indicator set the Operating Mode Setup parameter  $F_{0r}$  or  $F_{02}$  to  $r_d$ . Set the Remote indicator's  $H_5$  parameter to  $r_d$ . The Remote indicator will only function as a dummy terminal when configured as a Remote display mode. Only the UNITS, ZERO, TARE, GROSS NET keys and the display will function. Connect the fiber optic cables between both indicators with the cable ends reversed on the Remote Indicator. For the Primary indicator either Port 1 or Port 2 can be used. The Remote indicator uses only Port 1 for the interface.

Note: Remote Display can be run at the same time as the safe area fiber optic option. Each option requires one of the fiber optic ports 1 or 2 to operate.

# Troubleshooting

## General problem resolution:

Problem:	What to Do or Check:
Weight reading will not repeat or scale does not return to zero when weight is removed.	Make sure that there is nothing caught in the platform under or around the load cell or spider interfering with its movement.
Scale overloads early.	Make sure all four corner overload stops are properly set, if present. Take the platter off the scale, invert it and place it back on the spider. With 1/2 of the scale's capacity in test weights concentrated over a corner of the platform, there should be approximately 1/32" of clearance between the stop and the bottom of the spider. Check all four corners then recalibrate the scale. If the problem persists, it is possible that the scale is being shock-loaded causing the load cell to be shifted.
Scale will not indicate full capacity or go into overload.	Make sure that there is nothing caught in the scale under or around the load cell or spider, which would interfere with their movement. If not, check the overload stops using the above procedure.
Scale will not come to zero when the ZERO button is pressed.	Make sure that the scale is stable ("MOT" annunciator is off) when ZERO is pressed. If excessive motion is a problem, then it may be necessary to activate the latching print feature (P04) or lengthen the filter time (R45 (5)). If the scale is stable, the scale may be set to the Canadian Legal for Trade (4% zero bandwidth). An attempt is being made to zero more than 4% of capacity (see Parameter Setup section). There may be a problem with the touch-panel or main board.
Weight readings don't seem to be correct.	Check the scale's accuracy with a test weight. Recalibrate if necessary.
Scale drifts off of zero.	Check for air currents and/or vibration around the scale. If that is the cause, it may be necessary to set the AZT aperture to a wider setting to compensate (see Parameter Setup section).
Scale reading is bouncing or "flighty".	Check for air currents and/or vibration around the scale. If that is the cause, it may be necessary to set the Digital Averaging to a higher setting to stabilize the reading (see Parameter Setup section).

If you are still experiencing a problem with your scale, or if the problem you are having is not covered in the previous list, please contact your Doran Scales authorized dealer or contact Doran tech support at 630-879-1288.

## Scale Messages:

Message	Meaning
"ᄁᄁᄁᄁ" Function complete.	The scale has successfully completed the requested action.
"ᄁᄁᄁᄁ" Aborted function.	The requested action has been canceled prior to completion.
"ᄁᄁᄁᄁ" Parameter value saved.	The scale has successfully stored and verified parameter value in nonvolatile memory.
"ᄁᄁᄁᄁ" Release push button.	The scale has detected that a key has been depressed for more than 3 seconds.
"Ent Cd" Enter code	Enter password code, shown only when using the Front Panel CAL Access Feature.
"Clr Ac" Clear accum/counter	The Accumulator and Counter values are cleared out of nonvolatile memory.
"SU nEU" New firmware installed	This message appears when the scale detects that new firmware has been loaded into flash memory.
"CLr tr" Clear Tare weight	This message appears when a zero weight is entered for a tare value. Scale will switch to gross mode.
"SEtUP" Serial Setup Mode	When the scale is connected to a computer running the Scale Setup software.
"Login" User login prompt	When the scale is configured to run with QC Weigh software (ᄁᄁᄁᄁ and ᄁᄁᄁᄁ), a User ID number must be entered in order to operate the scale. See QC Weigh section for more information.
"Late" Late message	When the scale is configured to run with QC Weigh software (ᄁᄁᄁᄁ and ᄁᄁᄁᄁ), this message will appear when the Alarm countdown timer has timed out and the scale has been stable for more than 20 seconds. See QC Weigh section for more information.

## Error Messages:

Error Message	What to Do or Check:
"OVR LD" Scale overload	The scale is in overload. The load on the scale exceeds the capacity by more than 103%. Remove excess weight from scale.
"UDR LD" Scale underload	The scale is in underload. The load on the scale is less than the minimum scale capacity by more than -20%. Recalibrate scale or add additional dead load.
"GRS OL" Gross overload	The scale is in gross overload. The load exceeds the scale ratings and might result in damage to the scale. Remove excess weight immediately. Ignore this message for the first 5 seconds after power up.
"GRS UL" Gross underload	The scale is in gross underload. The load exceeds the minimum scale ratings and might result in damage to the scale. Load cell connections might be wired in reverse. Ignore this message for the first five seconds after power up.
"SU 0 E" Startup zero error	The scale was not stable. <u>This error will only occur in Legal for Trade applications.</u> The scale will zero once it becomes stable.
"ER AD" A/D failure	The scale has detected a failure in the A/D circuit. Have the scale serviced by a qualified scale repair technician.
"ER SR" SRAM error	The setup parameters loaded in nonvolatile memory (SRAM) have become corrupted. The scale requires recalibration by a qualified scale technician.
"ERR P" Program ROM error	The program memory in the scale has become corrupted. Have scale serviced by a qualified scale repair technician.
"LD 0 0" Loading zero.	The scale is attempting to load power up zero. This message will remain until scale is stable.
"SPRn E" Calibration Range Error	Calibration zero is out of range, refer to A/D Ranging section for additional information.
"ER nE9" Negative Weight Error	Weight is negative range, Load cell signal wires backwards, refer to A/D Ranging section for additional information.
"ER nno" Motion Error	Weight readings are unstable. Too much vibration occurs during weight entry. Load cell signal wires are not connected.
"rR Err" Calibration Span Error	Calibration Span is out of range, refer to A/D Ranging section for additional information.
"no SRU" Parameter value not saved.	The scale has <u>not</u> successfully stored or verified the parameter value in nonvolatile memory.
"ER CnE" Count by Error.	The weight value entered has a smaller count by step than the scale's current count by resolution.
"ER dP" Decimal Point Error.	Too many digits to the right of the decimal point have been entered for capacity.
"CRP r9" Capacity Range Error.	Capacity weight entered has more than three non-zero digits in a row.
"CRP Lo" Capacity weight is too low.	Capacity weight entered is less than 1 lb or kg.



"CAP 0" Capacity weight equals 0.	A zero weight has been entered for Capacity.
"Er bAt" SRAM low battery	Low battery voltage warning in nonvolatile memory (SRAM). The scale requires recalibration by a qualified scale technician.
"Er CL0" time/date clock error	The time/date has failed. The scale requires recalibration by a qualified scale technician.
"bUffEr" "Low" print buffer memory low	Warning message that the Print Buffer memory has more than 62,976 bytes stored in it. See Print Buffer section for more information on the Print Buffer operation.
"bUffEr" "FULL" print buffer memory full	Warning message that the Print Buffer memory has more than 65,024 bytes stored in it. No more data will be stored in the buffer memory. See Print Buffer section for more information on the Print Buffer operation.

# LOAD CELL AND SUMMING BOARD INSTALLATION DIAGRAM

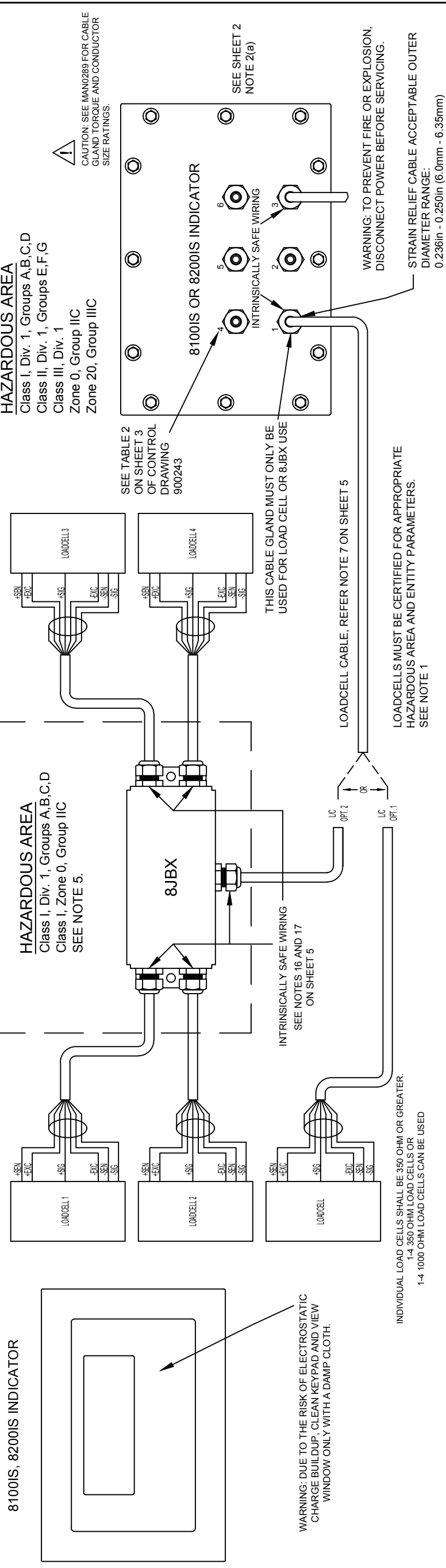

## 8100IS, 8200IS INDICATOR INTRINSICALLY SAFE OUTPUT WIRING AND LOADCELL CONFIGURATION JUMPERS

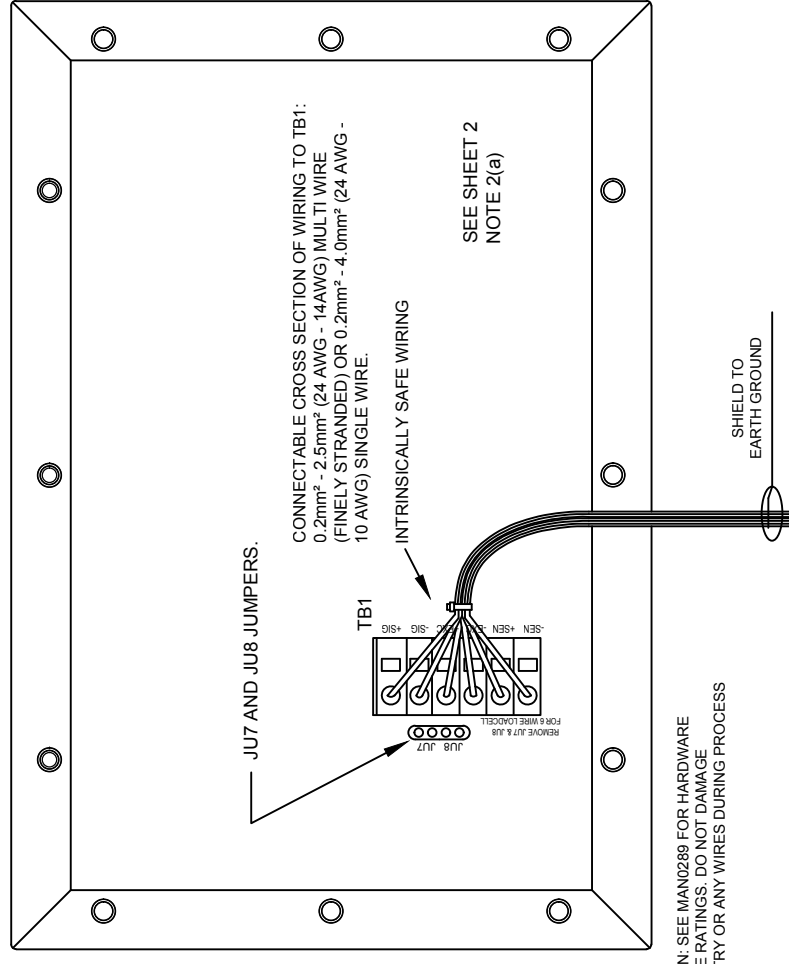

### 6-WIRE LOADCELL CONNECTION (REMOVE JU7 AND JU8)

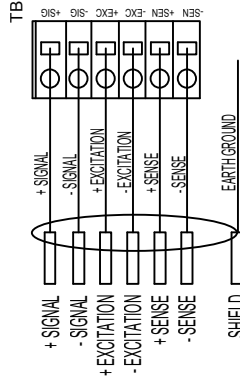

### 4-WIRE LOADCELL CONNECTION (INSERT JU7 AND JU8)

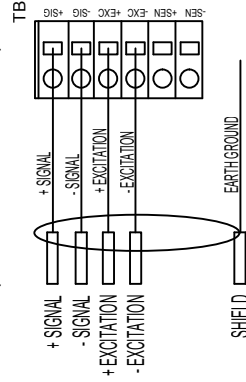

DESCRIPTION (LOCATION)	U <sub>o</sub>	I <sub>o</sub>	P <sub>o</sub>	C <sub>o</sub>	L <sub>o</sub>
LOADCELL (TB1)	7.14 V	0.7076 A	0.895 W	10.8 uF	71 uH

1. THESE OUTPUTS MAY ALSO BE CONNECTED TO SIMPLE APPARATUS AS DEFINED IN ARTICLE 504.2 AND INSTALLED AND TEMPERATURE CLASSIFIED IN ACCORDANCE WITH ARTICLE 504.10(D) OF THE NATIONAL ELECTRICAL CODE (ANSI/NFPA 70), OR OTHER LOCAL CODES, AS APPLICABLE.
2. SELECTED INTRINSICALLY SAFE EQUIPMENT/LOADCELLS (FOR USE WITH THESE INTRINSICALLY SAFE DORAN OUTPUTS) MUST BE THIRD PARTY LISTED AS INTRINSICALLY SAFE FOR THE APPLICATION (UNLESS DEEMED SIMPLE APPARATUS PER NOTE 1), AND HAVE INTRINSICALLY SAFE ENTITY PARAMETERS CONFORMING WITH TABLE 1 BELOW

I.S. Equipment/Loadcells	I.S. Doran Outputs
V max (or U <sub>i</sub> )	≥ Voc or Vt (or U <sub>o</sub> )
I max (or I <sub>i</sub> )	≥ Isc or It (or I <sub>o</sub> )
P max, P <sub>i</sub>	≥ P <sub>o</sub>
C <sub>i</sub> + C <sub>cable</sub>	≤ C <sub>a</sub> (or C <sub>o</sub> )
L <sub>i</sub> + L <sub>cable</sub>	≤ L <sub>a</sub> (or L <sub>o</sub> )

3. SEE PAGE 5 (NOTES FOR PAGE 1 OF CONTROL DRAWING No. 900243)

### WARNING

READ AND UNDERSTAND COMPLETELY USER MANUAL NO. MAN0289 FOR THESE DEVICES BEFORE INSTALLATION OR OPERATION

**doran**® DORAN SCALES, INC.  
www.doranscales.com

### SYSTEM CONTROL DRAWING

DATE: 05/04/18	DRAWN BY: J.TORRES	DRAWING NUMBER: 900243	SHEET NUMBER: SHEET 1 OF 5	REV: 06
----------------	--------------------	------------------------	----------------------------	---------

# POWER SUPPLY INSTALLATION DIAGRAM

ECD #	REV	REVISIONS	DATE	APP
18-037	01	BLOCK CHANGED/ABBREVIATIONS/NOTES	5/7/18	J.T
18-073	02	UL MARKUPS	11/5/18	J.T
19-006	03	MORE UL MARKUPS	01/11/19	J.T
19-008	04	STANDARD CONFIGURATION	01/23/19	J.T
19-011	05	TABLE 2 INTRODUCTION	02/06/19	J.T
19-020	06	FINAL UL MARKUPS	03/01/19	J.T

## UNCLASSIFIED (NON-HAZARDOUS AREA) OR HAZARDOUS AREA

Class I, Div 1, Groups B,C,D  
Class II, Div 1, Groups E,F,G  
Class III, Div. 1  
Class I, Zone 1, Group IIC  
Zone 21, Group IIIC

## UNCLASSIFIED (NON-HAZARDOUS) AREA

AC MAINS  
120VAC  
50/60Hz  
NOTE 3.

BLK. L  
WHT. N  
GRN. GND

CONDUIT, SEE NOTE 1.

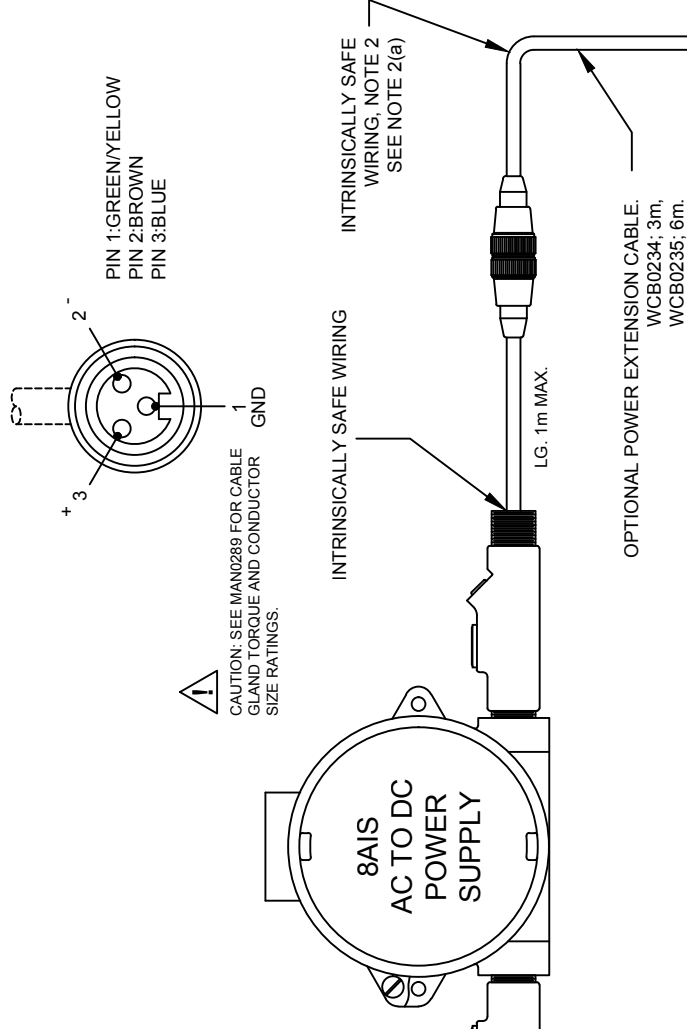

CAUTION: SEE MAN0289 FOR CABLE GLAND TORQUE AND CONDUCTOR SIZE RATINGS.

## 8CHG BATTERY CHARGER

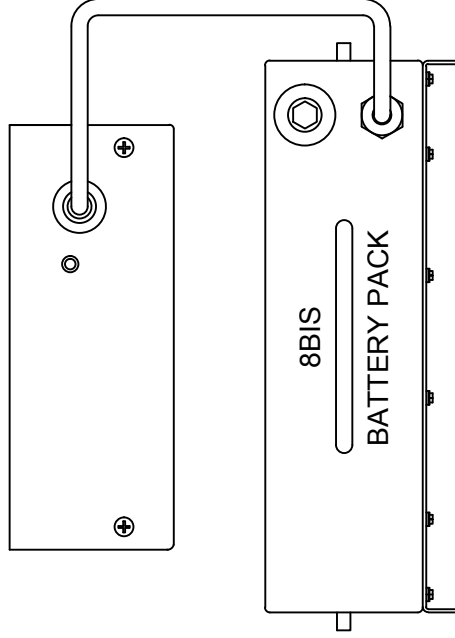

CHARGE BATTERY IN AN UNCLASSIFIED (NON-HAZARDOUS) AREA ONLY

## HAZARDOUS AREA

Class I, Div 1, Groups A,B,C,D  
Class II, Div 1, Groups E,F,G  
Class III, Div. 1  
Zone 0, Group IIC  
Zone 20, Group IIIC

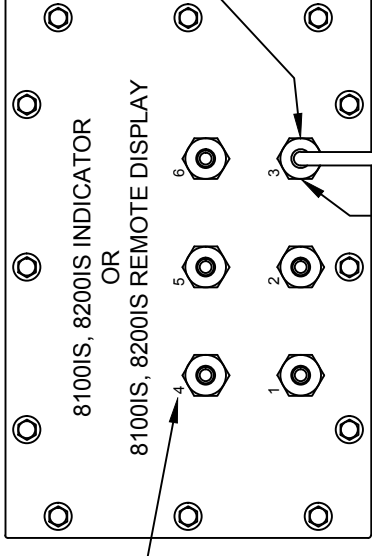

SEE TABLE 2 ON SHEET 3 OF CONTROL DRAWING 900243



CAUTION: SEE MAN0289 FOR CABLE GLAND TORQUE AND CONDUCTOR SIZE RATINGS.

INTRINSICALLY SAFE WIRING

SEE NOTE 2(a)

## HAZARDOUS AREA

Class I, Div 1, Groups A,B,C,D  
Class II, Div 1, Groups E,F,G  
Class III, Div. 1  
Zone 0, Group IIC  
Zone 20, Group IIIC

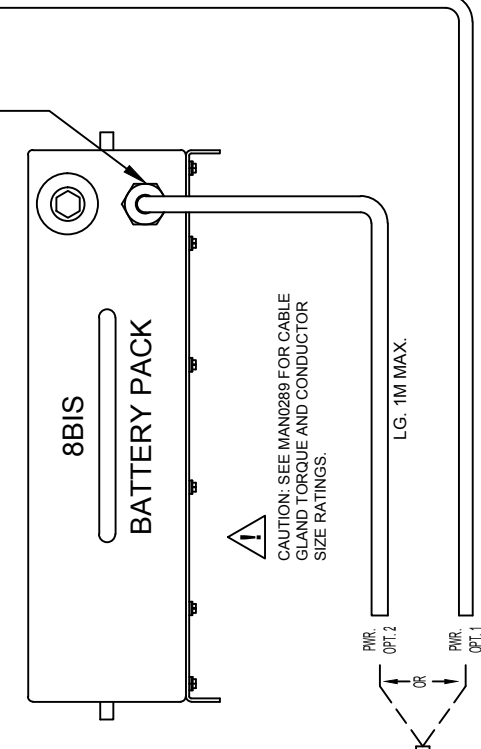

CAUTION: SEE MAN0289 FOR CABLE GLAND TORQUE AND CONDUCTOR SIZE RATINGS.

LG. 1M MAX.

INTRINSICALLY SAFE WIRING

OPTIONAL POWER EXTENSION CABLE.  
WCB0234: 3m,  
WCB0235: 6m.

INTRINSICALLY SAFE WIRING

INTRINSICALLY SAFE WIRING, NOTE 2  
SEE NOTE 2(a)

### NOTES:

- CONDUIT, FIELD WIRING AND SEALS SHALL COMPLY WITH NATIONAL AND LOCAL CODES OF THE AUTHORITY HAVING JURISDICTION (AHJ)
- INTRINSICALLY SAFE WIRING BETWEEN POWER SUPPLY AND INDICATOR/REMOTE DISPLAY SHALL USE ONLY FACTORY SUPPLIED CABLES.
  - BEFORE INSTALLATION, AND BEFORE CONNECTING/DISCONNECTING ANY FACTORY SUPPLIED CABLES, OR ANY FIELD WIRING FOR THE 8100IS/8200IS INDICATOR/REMOTE DISPLAY, ENSURE CONNECTORS ARE FREE OF DUST/DEBRIS AND ENSURE NO POTENTIALLY IGNITABLE DUST ATMOSPHERES ARE PRESENT.
- MAXIMUM NON-HAZARDOUS LOCATION VOLTAGE (Um) MUST NOT EXCEED 120V AND MUST BE AC ONLY.
- ALL GROUNDING CONNECTIONS MUST BE LESS THAN 1 OHM RESISTANCE TO EARTH GROUND.
- OPERATING AMBIENT TEMPERATURE RANGE: -10°C TO +40°C
- BATTERY CHARGER RATED AMBIENT IS -10°C TO +30°C
- INTRINSICALLY SAFE WIRING SHALL BE IDENTIFIED AS SUCH WITH LABELS PLACED NO MORE THAN 7.62M (25FT) APART. THE COLOR LIGHT BLUE IS INTERNATIONALLY RECOGNIZED AS IDENTIFYING INTRINSICALLY SAFE WIRING.
- SEE PAGE 5 (NOTES FOR PAGE 2 OF CONTROL DRAWING No. 900243)

### WARNING

READ AND UNDERSTAND COMPLETELY USER MANUAL NO. MAN0289 FOR THESE DEVICES BEFORE INSTALLATION OR OPERATION

**doran**® DORAN SCALES, INC.  
www.doranscales.com

### SYSTEM CONTROL DRAWING

DATE: 05/07/18	DRAWN BY: J.TORRES	DRAWING NUMBER 900243	SHEET NUMBER SHEET 2 OF 5	REV 06
-------------------	-----------------------	--------------------------	------------------------------	-----------

# FIBER OPTIC INTERFACE

## HAZARDOUS AREA

Class I, Div 1, Groups A, B, C, D  
 Class II, Div 1, Groups E, F, G  
 Class III, Div. 1  
 Zone 0, Group IIC  
 Zone 20, Group IIIC

## UNCLASSIFIED (NON-HAZARDOUS AREA)

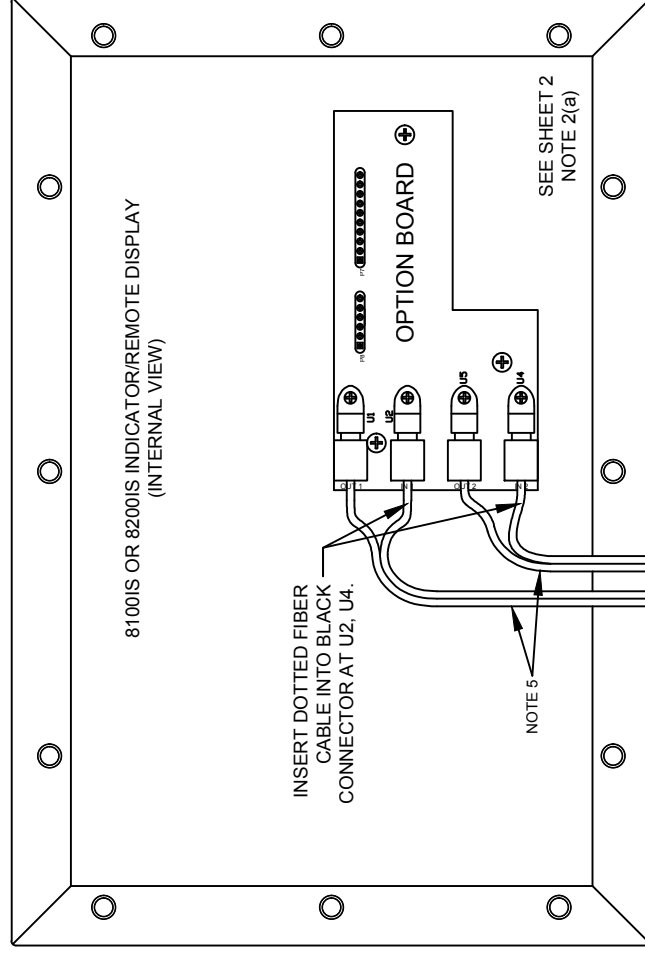
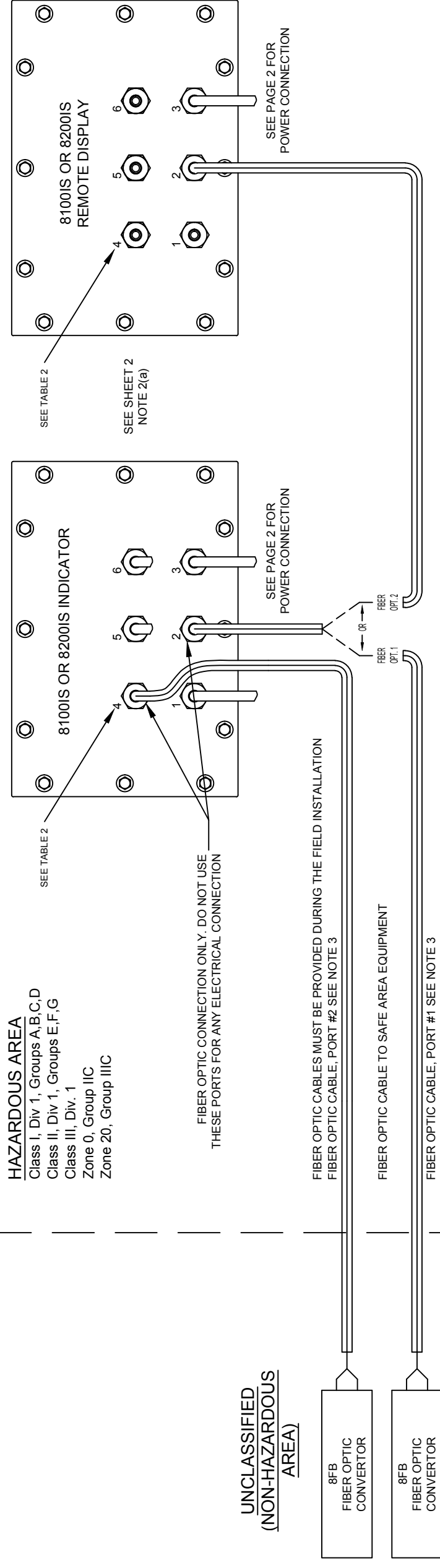

CAUTION: SEE MAN0289 FOR HARDWARE TORQUE RATINGS. DO NOT DAMAGE CIRCUITRY OR ANY WIRES DURING PROCESS

FIBER OPTIC CABLE 1  
 OUT 1 & IN 1  
 (USE FOR FIBER OPTIC CONVERTER)  
 OR  
 (USE FOR FIBER OPTIC CABLES TO U5, U4 FOR REMOTE DISPLAY)

FIBER OPTIC CABLE 2:  
 OUT 2 & IN 2  
 (USE ONLY FOR FIBER OPTIC CONVERTER)  
 OR  
 (USE FOR FIBER OPTIC CABLES TO U5, U4 FOR REMOTE DISPLAY)

### NOTES:

1. OPERATING AMBIENT TEMPERATURE RANGE: -10°C TO +40°C (EXCEPT 8CHG RANGE: -10°C TO +30°C)
2. NOTE: THE 8100IS OR 8200IS REMOTE DISPLAY REQUIRES A SEPARATE POWER SUPPLY OR BATTERY PACK.
3. ANY FIBER OPTIC CABLES SHALL BE INSTALLED IN ACCORDANCE WITH ARTICLES 500.8, 501.10, 501.15, 502.10, 502.15, 503, 505.15, 506.9, AND 506.15 OF THE NATIONAL ELECTRICAL CODE (ANSI/NFPA 70) OR OTHER LOCAL CODES, AS APPLICABLE
4. MODEL 8FB WAS EVALUATED AS OPEN EQUIPMENT. OPEN EQUIPMENT IS INTENDED TO BE FIELD INSTALLED WITHIN A SEPARATE OVERALL ENCLOSURE OR END-PRODUCT EQUIPMENT ENCLOSURE. RUN EACH CABLE PAIRS THRU GLAND TO THE DEVICES FIBER OPTIC PORTS. INSERT MARKED CABLE TO RCV(IN) PORT AND THE UNMARKED TO XMT(OUT) PORT.

### KEY:

L - LOAD CELL OR 8JIBX CONNECTION  
 F - FIBER OPTIC ONLY  
 P - I.S. POWER INPUT ONLY  
 RS - REMOTE SWITCH OUTPUT ONLY  
 (SS) - STAINLESS STEEL PLUG

TABLE 2

I/O Port Number	8100IS Indicator	8200IS Indicator	8100IS Remote Display	8200IS Remote Display
1	L	L	(SS)	(SS)
2	F	F	F	F
3	P	P	P	P
4	F	F	(SS)	(SS)
5	RS	RS	(SS)	(SS)
6	RS	RS	(SS)	(SS)

ECD #	REV	REVISIONS	DATE	APP
18-037	01	BLOCK CHANGED/ABBREVIATIONS/NOTES	5/7/18	J.T
18-073	02	UL MARKUPS	11/5/18	J.T
19-006	03	MORE UL MARKUPS	01/11/19	J.T
19-008	04	STANDARD CONFIGURATION	01/23/19	J.T
19-011	05	TABLE 2 INTRODUCTION	02/06/19	J.T
19-020	06	FINAL UL MARKUPS	03/01/19	J.T

CAUTION: SEE MAN0289 FOR CABLE CLAMP TORQUE AND CONDUCTOR SIZE RATINGS.

**doran**<sup>®</sup> DORAN SCALES, INC.  
 www.doranscales.com

### WARNING

READ AND UNDERSTAND COMPLETELY USER MANUAL NO. MAN0289 FOR THESE DEVICES BEFORE INSTALLATION OR OPERATION

### SYSTEM CONTROL DRAWING

DATE: 05/07/18  
 DRAWN BY: J. TORRES  
 DRAWING NUMBER: 900243  
 SHEET NUMBER: SHEET 3 OF 5  
 REV: 06

# REMOTE SWITCH WIRING

## HAZARDOUS AREA

Class I, Div 1, Groups A,B,C,D  
 Class II, Div 1, Groups E,F,G  
 Class III, Div. 1  
 Zone 0, Group IIC  
 Zone 20, Group IIIC

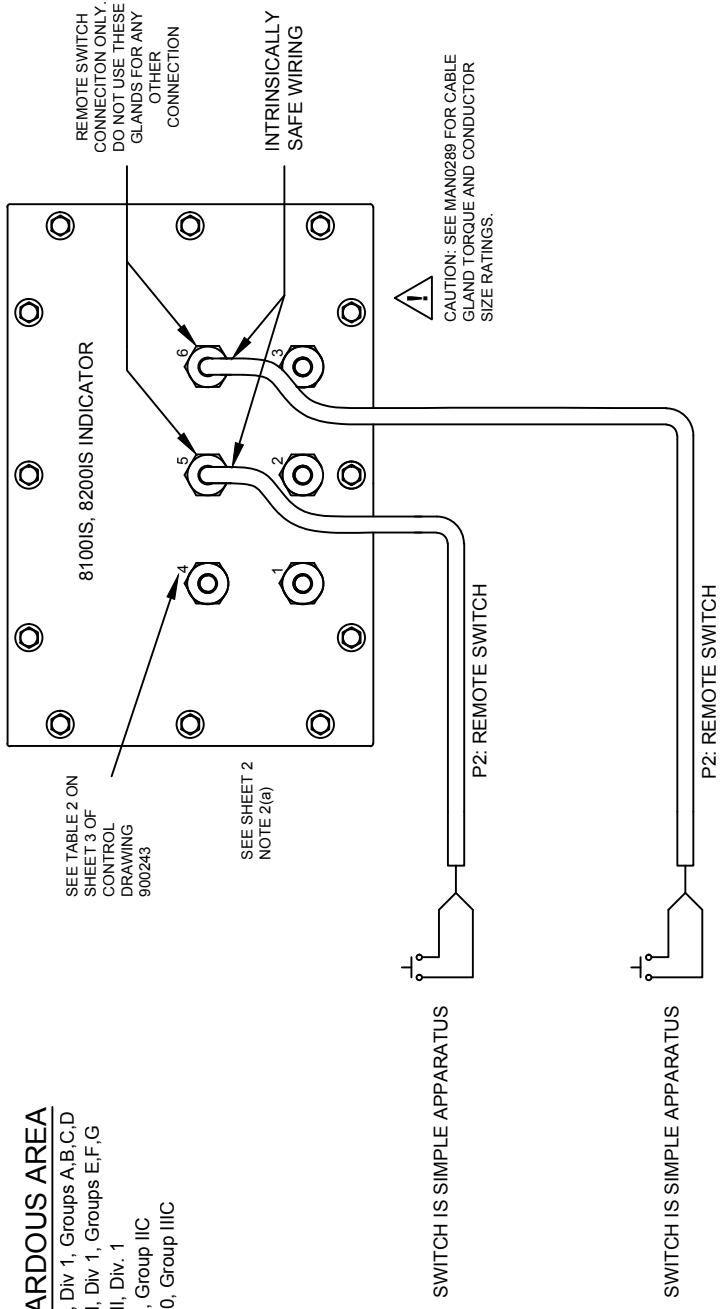

SWITCH IS SIMPLE APPARATUS

SWITCH IS SIMPLE APPARATUS

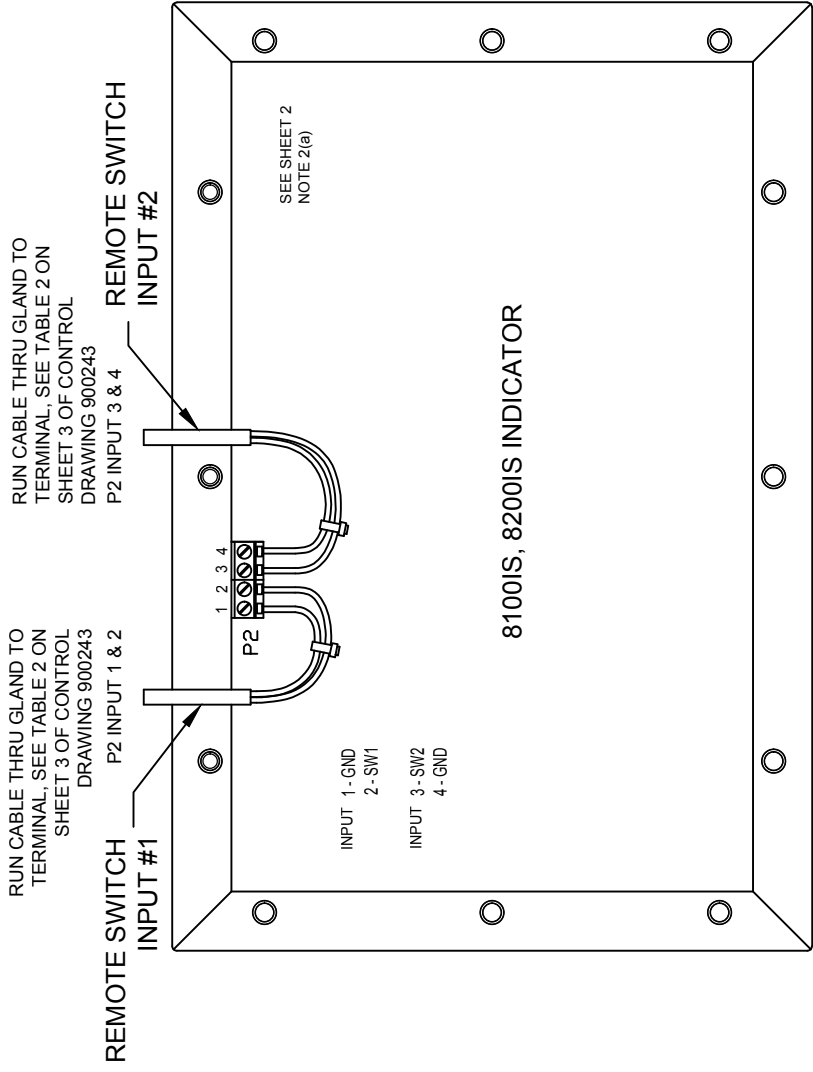

SWITCH IS SIMPLE APPARATUS

SWITCH IS SIMPLE APPARATUS

OUTPUT ENTITY PARAMETERS					
DESCRIPTION (LOCATION)	U <sub>0</sub>	I <sub>0</sub>	P <sub>0</sub>	C <sub>0</sub>	L <sub>0</sub>
REMOTE SWITCH #1 & #2	7.14 V	0.133 A	0.217 W	13.5 uF	2.02 mH

### NOTES:

1. THE DORAN I.S. OUTPUT CABLE MUST BE CONNECTED TO A SUITABLE GROUND ELECTRODE PER THE NATIONAL ELECTRICAL CODE (ANSI/NFPA 70), THE CANADIAN ELECTRICAL CODE OR OTHER LOCAL INSTALLATION CODES, AS APPLICABLE. THE RESISTANCE OF THE GROUND PATH MUST BE LESS THAN 1 OHM.
2. OPERATING AMBIENT TEMPERATURE RANGE: -10°C TO +40°C (EXCEPT 8CHG RANGE: -10°C TO +30°C)
3. INTRINSICALLY SAFE WIRING SHALL BE IDENTIFIED AS SUCH WITH LABELS PLACED NO MORE THAN 7.62M (25FT) APART. THE COLOR LIGHT BLUE IS INTERNATIONALLY RECOGNIZED AS IDENTIFYING INTRINSICALLY SAFE WIRING.
4. THE OUTPUT CURRENT OF THESE INTRINSICALLY SAFE DORAN OUTPUTS IS LIMITED BY A RESISTOR SUCH THAT THE OUTPUT VOLTAGE-CURRENT PLOT IS A STRAIGHT LINE DRAWN BETWEEN OPEN-CIRCUIT VOLTAGE AND SHORT-CIRCUIT CURRENT
5. SELECTED INTRINSICALLY SAFE EQUIPMENT/SWITCHES (FOR USE WITH THESE INTRINSICALLY SAFE DORAN OUTPUTS) MUST BE THIRD PARTY LISTED AS INTRINSICALLY SAFE FOR THE APPLICATION (UNLESS DEEMED SIMPLE APPARATUS PER NOTE 11 ON SHEET 4, AND HAVE INTRINSICALLY SAFE ENTITY PARAMETERS CONFORMING WITH TABLE 1 BELOW.

TABLE 1	
I.S. Equipment/Switches	I.S. Doran Outputs
V max (or U <sub>i</sub> )	≥ Voc or Vt (or U <sub>o</sub> )
I max (or I <sub>i</sub> )	≥ I <sub>sc</sub> or I <sub>t</sub> (or I <sub>o</sub> )
P max, P <sub>i</sub>	≥ P <sub>o</sub>
C <sub>i</sub> + C <sub>cable</sub>	≤ Ca (or Co)
L <sub>i</sub> + L <sub>cable</sub>	≤ La (or Lo)

6. CAPACITANCE AND INDUCTANCE OF THE FIELD WIRING FROM THE INTRINSICALLY SAFE EQUIPMENT/SWITCHES TO THESE INTRINSICALLY SAFE DORAN OUTPUTS SHALL BE CALCULATED AND MUST BE INCLUDED IN THE SYSTEM CALCULATIONS AS SHOWN IN TABLE 1. CABLE CAPACITANCE, C<sub>cable</sub>, PLUS INTRINSICALLY SAFE EQUIPMENT CAPACITANCE, C<sub>i</sub> MUST BE LESS THAN THE MARKED CAPACITANCE, Ca (OR Co), SHOWN ON ANY I.S. DORAN OUTPUTS USED. THE SAME APPLIES FOR INDUCTANCE (L<sub>cable</sub>, L<sub>i</sub> AND L<sub>a</sub> OR L<sub>o</sub>, RESPECTIVELY). WHERE THE CABLE CAPACITANCE AND INDUCTANCE PER FOOT ARE NOT KNOWN, THE FOLLOWING VALUES SHALL BE USED: C<sub>cable</sub> = 60 pF/ft., L<sub>cable</sub> = 0.2 H/ft.
7. WHERE MULTIPLE CIRCUITS EXTEND FROM THE SAME PIECE OF ASSOCIATED APPARATUS OR INTRINSICALLY SAFE DEVICE (WHERE ALL PINS ARE NOT STATED AS COMBINED AND/OR DIFFERENT ENTITY PARAMETERS ASSIGNED), THEY MUST BE INSTALLED IN SEPARATE CABLES OR IN ONE CABLE HAVING SUITABLE INSULATION. REFER TO ARTICLE 504.30(B) OF THE NATIONAL ELECTRICAL CODE (ANSI/NFPA 70) AND INSTRUMENT SOCIETY OF AMERICA RECOMMENDED PRACTICE ISA RP12.06 FOR INSTALLING INTRINSICALLY SAFE EQUIPMENT
8. INTRINSICALLY SAFE CIRCUITS MUST BE WIRED AND SEPARATED IN ACCORDANCE WITH ARTICLE 504.20 OF THE NATIONAL ELECTRICAL CODE (ANSI/NFPA 70) OR OTHER LOCAL CODES, AS APPLICABLE.
9. THESE INTRINSICALLY SAFE DORAN OUTPUTS HAVE NOT BEEN EVALUATED FOR USE IN COMBINATION WITH ANOTHER DEVICE WITH ANY OUTPUTS.
10. FOR INSTALLATIONS IN WHICH BOTH THE C<sub>i</sub> AND L<sub>i</sub> OF THE INTRINSICALLY SAFE APPARATUS/SWITCHES EXCEEDS 1% OF THE Ca (OR Co) AND La (OR Lo) PARAMETERS OF THESE INTRINSICALLY SAFE DORAN OUTPUTS (EXCLUDING THE CABLE), THEN 50% OF Ca (OR Co) AND La (OR Lo) PARAMETERS ARE APPLICABLE AND SHALL NOT BE EXCEEDED. THE REDUCED CAPACITANCE SHALL NOT BE GREATER THAN 1 F FOR GROUPS C AND/OR D, AND 600 nF FOR GROUPS A AND B. THE VALUES OF Ca (OR Co) AND La (OR Lo) DETERMINED BY THIS METHOD SHALL NOT BE EXCEEDED BY THE SUM OF ALL OF C<sub>i</sub> PLUS CABLE CAPACITANCES AND THE SUM OF ALL OF THE L<sub>i</sub> PLUS CABLE INDUCTANCES IN THE CIRCUIT RESPECTIVELY.
11. THESE INTRINSICALLY SAFE DORAN OUTPUTS MAY ALSO BE CONNECTED TO SIMPLE APPARATUS AS DEFINED IN ARTICLE 504.2 AND INSTALLED AND TEMPERATURE CLASSIFIED IN ACCORDANCE WITH ARTICLE 504.10(D) OF THE NATIONAL ELECTRICAL CODE (ANSI/NFPA 70), OR OTHER LOCAL CODES, AS APPLICABLE.



CAUTION: SEE MAN0289 FOR HARDWARE TORQUE RATINGS. DO NOT DAMAGE CIRCUITRY OR ANY WIRES DURING PROCESS

## WARNING

READ AND UNDERSTAND COMPLETELY USER MANUAL NO. MAN0289 FOR THESE DEVICES BEFORE INSTALLATION OR OPERATION

**doran**<sup>®</sup> DORAN SCALES, INC.  
 www.doranscales.com

## SYSTEM CONTROL DRAWING

DATE: 05/07/18	DRAWN BY: J.TORRES	DRAWING NUMBER 900243	SHEET NUMBER SHEET 4 OF 5	REV 06
-------------------	-----------------------	--------------------------	------------------------------	-----------

ECD #	REV	REVISIONS	DATE	APP
18-037	01	BLOCK CHANGED/ABBREVIATIONS/TABLE MADE	5/7/18	J.T
18-073	02	UL MARKUPS	11/5/18	J.T
19-006	03	MORE UL MARKUPS	01/11/19	J.T
19-008	04	STANDARD CONFIGURATION	01/23/19	J.T
19-011	05	TABLE 2 INTRODUCTION	02/06/19	J.T
19-020	06	FINAL UL MARKUPS	03/01/19	J.T

# NOTES FOR PAGE 1 OF CONTROL DRAWING No. 900243

## NOTES:

- SEE PAGE 1
- SEE PAGE 1
- SEE PAGE 1
- CONNECT THE LOADCELL CABLE SHIELD WIRE TO THE THREADED STUD ADJACENT TO SEALING GLAND. TO ASSURE PROPER GROUNDING, TEST FOR CONTINUITY BETWEEN PLATFORM(LOAD CELL) AND SHIELD. THE PLATFORM SHOULD BE PROPERLY GROUNDING TO EARTH.
- THE DORAN I.S. OUTPUT CABLE MUST BE CONNECTED TO A SUITABLE GROUND ELECTRODE PER THE NATIONAL ELECTRICAL CODE (ANSI/NFPA 70), THE CANADIAN ELECTRICAL CODE OR OTHER LOCAL INSTALLATION CODES. AS APPLICABLE. THE RESISTANCE OF THE GROUND PATH MUST BE LESS THAN 1 OHM.
- OPERATING AMBIENT TEMPERATURE RANGE: -10°C TO +40°C
- LOADCELL CABLE LENGTH: 75 FEET MAX FOR THE 4-WIRE LOADCELLS, AND 50 FEET MAX FOR THE 6-WIRE LOADCELLS. THESE MUST INCLUDE TOTAL LENGTH OF CABLE STARTING AT INDICATOR AND ENDING AT EACH LOADCELL (ALL COMBINED).
- 8JBX JUNCTION BOX IS TYPE 1, IP20 FOR DRY INDOOR LOCATIONS.
- THE OUTPUT CURRENT OF THESE INTRINSICALLY SAFE DORAN OUTPUTS IS LIMITED BY A RESISTOR SUCH THAT THE OUTPUT VOLTAGE-CURRENT PLOT IS A STRAIGHT LINE DRAWN BETWEEN OPEN-CIRCUIT VOLTAGE AND SHORT-CIRCUIT CURRENT.
- SELECTED INTRINSICALLY SAFE EQUIPMENT/LOADCELLS (FOR USE WITH THESE INTRINSICALLY SAFE DORAN OUTPUTS) MUST BE THIRD PARTY LISTED AS INTRINSICALLY SAFE FOR THE APPLICATION (UNLESS DEEMED SIMPLE APARATUS PER NOTE 1 ON SHEET 1), AND HAVE INTRINSICALLY SAFE ENTITY PARAMETERS CONFORMING WITH TABLE 1 ON SHEET 1.
- CAPACITANCE AND INDUCTANCE OF THE FIELD WIRING FROM THE INTRINSICALLY SAFE EQUIPMENT/LOADCELLS TO THESE INTRINSICALLY SAFE DORAN OUTPUTS SHALL BE CALCULATED AND MUST BE INCLUDED IN THE SYSTEM CALCULATIONS AS SHOWN IN TABLE 1 ON SHEET 1. CABLE CAPACITANCE, Ccable, PLUS INTRINSICALLY SAFE EQUIPMENT CAPACITANCE, Ci MUST BE LESS THAN MARKED CAPACITANCE, Ca (OR Co), SHOWN ON ANY I.S. DORAN OUTPUTS USED. THE SAME APPLIES FOR INDUCTANCE (Lcable, Li AND La OR Lo, RESPECTIVELY), WHERE THE CABLE CAPACITANCE AND INDUCTANCE PER FOOT ARE NOT KNOWN, THE FOLLOWING VALUES SHALL BE USED: Ccable = 60 pF/ft., Lcable = 0.2 H/ft.
- WHERE MULTIPLE CIRCUITS EXTEND FROM THE SAME PIECE OF ASSOCIATED APPARATUS OR INTRINSICALLY SAFE DEVICE (WHERE ALL PINS ARE NOT STATED AS COMBINED AND/OR DIFFERENT ENTITY PARAMETERS ASSIGNED), THEY MUST BE INSTALLED IN SEPARATE CABLES OR IN ONE CABLE HAVING SUITABLE INSULATION, REFER TO ARTICLE 504.30(B) OF THE NATIONAL ELECTRICAL CODE (ANSI/NFPA 70) AND INSTRUMENT SOCIETY OF AMERICA RECOMMENDED PRACTICE ISA RP12.06 FOR INSTALLING INTRINSICALLY SAFE EQUIPMENT.
- INTRINSICALLY SAFE CIRCUITS MUST BE WIRED AND SEPARATED IN ACCORDANCE WITH ARTICLE 504.20 OF THE NATIONAL ELECTRICAL CODE (ANSI/NFPA 70) OR OTHER LOCAL CODES, AS APPLICABLE.
- THESE INTRINSICALLY SAFE DORAN OUTPUTS HAVE NOT BEEN EVALUATED FOR USE IN COMBINATION WITH ANOTHER DEVICE WITH ANY OUTPUTS.
- FOR INSTALLATIONS IN WHICH BOTH THE Ci AND Li OF THE INTRINSICALLY SAFE APPARATUS/LOADCELLS EXCEEDS 1% OF THE Ca (OR Co) AND La (OR Lo) PARAMETERS OF THESE INTRINSICALLY SAFE DORAN OUTPUTS (EXCLUDING THE CABLE), THEN 50% OF Ca (OR Co) AND La (OR Lo) PARAMETERS ARE APPLICABLE AND SHALL NOT BE EXCEEDED. THE REDUCED CAPACITANCE SHALL NOT BE GREATER THAN 1 F FOR GROUPS C AND/OR D, AND 600 nF FOR GROUPS A AND B. THE VALUES OF Ca (OR Co) AND La (OR Lo) DETERMINED BY THIS METHOD SHALL NOT BE EXCEEDED BY THE SUM OF ALL OF Ci PLUS CABLE CAPACITANCES AND THE SUM OF ALL OF THE Li PLUS CABLE INDUCTANCES IN THE CIRCUIT RESPECTIVELY.
- 8JBX LOAD CELL I.S. WIRING BELOW
- 8JBX OUTPUT ENTITY PARAMETERS BELOW

### 6-WIRE LOADCELL CONNECTION

8BX BOARD INSIDE BOX

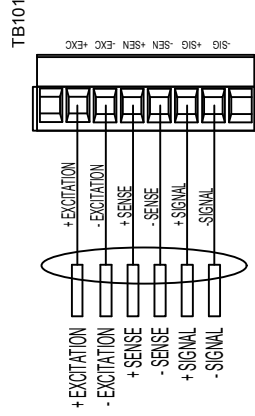

### 4-WIRE LOADCELL CONNECTION

8BX BOARD INSIDE BOX

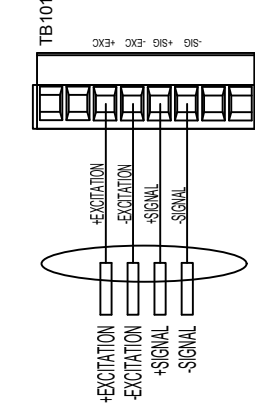

OUTPUT ENTITY PARAMETERS					
DESCRIPTION (LOCATION)	Uo	Io	Po	Co	Lo
LOADCELL (TB102-TB105)	7.14 V	0.7076 A	0.895 W	10.8 uF*	71 uH**

\*Co (subtract) C\_loadcell\_cable\_from\_indicator

\*\*Lo (subtract) L\_loadcell\_cable\_from\_indicator

## NOTES:

- NOTES 1-8 SEE PAGE 2
- THE ELECTRONICS LOCATED IN THE BARRIER CIRCUIT OF MODEL 8A1S FORMS AN INTRINSICALLY SAFE SYSTEM WHEN ONE INDICATOR/REMOTE DISPLAY MODEL 8100I/8200IS IS CONNECTED TO ITS INTRINSICALLY SAFE OUTPUT CABLE AS SHOWN ON SHEET 2, AND THE INDICATOR/REMOTE DISPLAY MODELS 8100I/8200IS ARE SUITABLE FOR USE IN HAZARDOUS AREAS AS SHOWN ON THIS CONTROL DRAWING NO. 900243. NO OTHER DEVICES ARE SUITABLE FOR DIRECT CONNECTION TO THE INTRINSICALLY SAFE OUTPUT CABLE OF MODEL 8A1S, AND THE ONLY ADDITIONAL DEVICES/CONFIGURATIONS THAT MAY BE CONNECTED TO THE INDICATOR/REMOTE DISPLAY MODELS 8100I/8200IS ARE SHOWN ON THIS CONTROL DRAWING NO. 900243
- THE OUTPUT CURRENT OF THE MODEL 8A1S ASSOCIATED APPARATUS IS LIMITED BY A RESISTOR SUCH THAT THE OUTPUT-VOLTAGE PLOT IS A STRAIGHT LINE DRAWN BETWEEN OPEN-CIRCUIT VOLTAGE AND SHORT-CIRCUIT CURRENT.
- ASSOCIATED APPARATUS MODEL 8A1S MUST BE INSTALLED IN AN ENCLOSURE SUITABLE FOR THE APPLICATION IN ACCORDANCE WITH THE NATIONAL ELECTRICAL CODE (ANSI/NFPA 70) FOR INSTALLATION IN THE UNITED STATES, THE CANADIAN ELECTRICAL CODE FOR INSTALLATIONS IN CANADA, OR OTHER LOCAL CODES, AS APPLICABLE.
- THE ASSOCIATED APPARATUS MODEL 8A1S MUST BE CONNECTED TO A SUITABLE GROUND ELECTRODE PER THE NATIONAL ELECTRICAL CODE (ANSI/NFPA 70), THE CANADIAN ELECTRICAL CODE OR OTHER LOCAL INSTALLATION CODES, AS APPLICABLE.
- THE RESISTANCE OF THE GROUND PATH MUST BE LESS THAN 1 OHM.
- INTRINSICALLY SAFE CIRCUITS MUST BE WIRED AND SEPARATED IN ACCORDANCE WITH ARTICLE 504.20 OF THE NATIONAL ELECTRICAL CODE (ANSI/NFPA 70) OR OTHER LOCAL CODES, AS APPLICABLE.
- THIS ASSOCIATED APPARATUS MODEL 8A1S HAS NOT BEEN EVALUATED FOR USE IN COMBINATION WITH ANOTHER ASSOCIATED APPARATUS.
- THE ELECTRONICS LOCATED IN THE MODEL 8B1S BATTERY PACK FORMS AN INTRINSICALLY SAFE SYSTEM WHEN ONE INDICATOR/REMOTE DISPLAY MODEL 8100I/8200IS IS CONNECTED TO ITS INTRINSICALLY SAFE OUTPUT CABLE AS SHOWN ABOVE, AND THE INDICATOR/REMOTE DISPLAY MODELS 8100I/8200IS ARE SUITABLE FOR USE IN HAZARDOUS AREAS AS SHOWN ON THIS CONTROL DRAWING NO. 900243. NO OTHER DEVICES ARE SUITABLE FOR DIRECT CONNECTION TO THE INTRINSICALLY SAFE OUTPUT CABLE OF MODEL 8B1S, AND THE ONLY ADDITIONAL DEVICES/CONFIGURATIONS THAT MAY BE CONNECTED TO THE INDICATOR/REMOTE DISPLAY MODELS 8100I/8200IS ARE SHOWN ON THIS CONTROL DRAWING NO. 900243.
- THE OUTPUT CURRENT OF THE MODEL 8B1S IS LIMITED BY A RESISTOR SUCH THAT THE OUTPUT VOLTAGE-CURRENT PLOT IS A STRAIGHT LINE DRAWN BETWEEN OPEN-CIRCUIT VOLTAGE AND SHORT-CIRCUIT CURRENT.
- MODEL 8BJX MUST BE INSTALLED IN AN ENCLOSURE SUITABLE FOR THE APPLICATION IN ACCORDANCE WITH THE NATIONAL ELECTRICAL CODE (ANSI/NFPA 70) FOR INSTALLATION IN THE UNITED STATES, THE CANADIAN ELECTRICAL CODE FOR INSTALLATIONS IN CANADA, OR OTHER LOCAL CODES, AS APPLICABLE.
- INTRINSICALLY SAFE CIRCUITS MUST BE WIRED AND SEPARATED IN ACCORDANCE WITH ARTICLE 504.20 OF THE NATIONAL ELECTRICAL CODE (ANSI/NFPA 70) OR OTHER LOCAL CODES, AS APPLICABLE.
- THIS BATTERY PACK MODEL 8B1S HAS NOT BEEN EVALUATED FOR USE IN COMBINATION WITH ANOTHER POWER SOURCE OR ASSOCIATED APPARATUS.
- THE INDICATOR/REMOTE DISPLAY MODEL 8100I/8200IS IS PROVIDED WITH A PERMANENTLY CONNECTED CABLE HAVING THE FOLLOWING CHARACTERISTICS:  
TURCK PART NO. RSM 30-2M UL/C-UL LISTED (E141522)  
RATED 300 V, 9 A, 105C  
3 WIRES, 18 AWG  
IP67 INGRESS PROTECTION  
MAXIMUM CAPACITANCE PER FOOT: 23.6 pF/ft  
MAXIMUM INDUCTANCE PER FOOT: 41.985 uH/ft  
MINIMUM CABLE JACKET INSULATION: 1.806 mm
- THE MODEL 8B1S IS PROVIDED WITH A PERMANENTLY CONNECTED CABLE HAVING THE FOLLOWING CHARACTERISTICS:  
TURCK PART NO. RKM 30-2M UL/C-UL LISTED (E141522)  
RATED 300 V, 9 A, 105C  
3 WIRES, 18 AWG  
IP67 INGRESS PROTECTION  
MAXIMUM CAPACITANCE PER FOOT: 23.6 pF/ft  
MAXIMUM INDUCTANCE PER FOOT: 41.985 uH/ft  
MINIMUM CABLE JACKET INSULATION: 1.806 mm
- SUITABILITY FOR INSTALLATION IN PARTICULAR APPLICATIONS IS AT THE DISCRETION OF THE AUTHORITY HAVING JURISDICTION (AHJ).
- THE OPTIONAL POWER EXTENSION CABLES WCB0234 AND WCB0235 MAY ONLY BE THE FOLLOWING TYPES IF USED:  
TURCK PART NO. P-RSM RKM 30-026-3M OR P-RSM RKM 30-026-6M  
UL/C-UL LISTED (E141522)  
RATED 300 V, 9 A, 105C  
3 WIRES, 18 AWG; AND 1 FOIL SHIELD, 20 AWG  
IP67 INGRESS PROTECTION  
MAXIMUM CAPACITANCE PER FOOT: 76.8 pF/ft  
MAXIMUM INDUCTANCE PER FOOT: 41.985 uH/ft  
MINIMUM CABLE JACKET INSULATION: 1.806 mm
- SUITABILITY FOR INSTALLATION IN PARTICULAR APPLICATIONS IS AT THE DISCRETION OF THE AUTHORITY HAVING JURISDICTION (AHJ).

## WARNING

READ AND UNDERSTAND COMPLETELY USER MANUAL NO. MAN0289 FOR THESE DEVICES BEFORE INSTALLATION OR OPERATION

**doran**<sup>®</sup> DORAN SCALES, INC.  
www.doranscales.com

## SYSTEM CONTROL DRAWING

DATE: 05/07/18	DRAWN BY: J.TORRES	DRAWING NUMBER 900243	SHEET NUMBER SHEET 5 OF 5	REV 02
-------------------	-----------------------	--------------------------	------------------------------	-----------

# NOTES FOR PAGE 2 OF CONTROL DRAWING No. 900243

## NOTES:

- NOTES 1-8 SEE PAGE 2
- THE ELECTRONICS LOCATED IN THE BARRIER CIRCUIT OF MODEL 8A1S FORMS AN INTRINSICALLY SAFE SYSTEM WHEN ONE INDICATOR/REMOTE DISPLAY MODEL 8100I/8200IS IS CONNECTED TO ITS INTRINSICALLY SAFE OUTPUT CABLE AS SHOWN ON SHEET 2, AND THE INDICATOR/REMOTE DISPLAY MODELS 8100I/8200IS ARE SUITABLE FOR USE IN HAZARDOUS AREAS AS SHOWN ON THIS CONTROL DRAWING NO. 900243. NO OTHER DEVICES ARE SUITABLE FOR DIRECT CONNECTION TO THE INTRINSICALLY SAFE OUTPUT CABLE OF MODEL 8A1S, AND THE ONLY ADDITIONAL DEVICES/CONFIGURATIONS THAT MAY BE CONNECTED TO THE INDICATOR/REMOTE DISPLAY MODELS 8100I/8200IS ARE SHOWN ON THIS CONTROL DRAWING NO. 900243
- THE OUTPUT CURRENT OF THE MODEL 8A1S ASSOCIATED APPARATUS IS LIMITED BY A RESISTOR SUCH THAT THE OUTPUT-VOLTAGE PLOT IS A STRAIGHT LINE DRAWN BETWEEN OPEN-CIRCUIT VOLTAGE AND SHORT-CIRCUIT CURRENT.
- ASSOCIATED APPARATUS MODEL 8A1S MUST BE INSTALLED IN AN ENCLOSURE SUITABLE FOR THE APPLICATION IN ACCORDANCE WITH THE NATIONAL ELECTRICAL CODE (ANSI/NFPA 70) FOR INSTALLATION IN THE UNITED STATES, THE CANADIAN ELECTRICAL CODE FOR INSTALLATIONS IN CANADA, OR OTHER LOCAL CODES, AS APPLICABLE.
- THE ASSOCIATED APPARATUS MODEL 8A1S MUST BE CONNECTED TO A SUITABLE GROUND ELECTRODE PER THE NATIONAL ELECTRICAL CODE (ANSI/NFPA 70), THE CANADIAN ELECTRICAL CODE OR OTHER LOCAL INSTALLATION CODES, AS APPLICABLE.
- THE RESISTANCE OF THE GROUND PATH MUST BE LESS THAN 1 OHM.
- INTRINSICALLY SAFE CIRCUITS MUST BE WIRED AND SEPARATED IN ACCORDANCE WITH ARTICLE 504.20 OF THE NATIONAL ELECTRICAL CODE (ANSI/NFPA 70) OR OTHER LOCAL CODES, AS APPLICABLE.
- THIS ASSOCIATED APPARATUS MODEL 8A1S HAS NOT BEEN EVALUATED FOR USE IN COMBINATION WITH ANOTHER ASSOCIATED APPARATUS.
- THE ELECTRONICS LOCATED IN THE MODEL 8B1S BATTERY PACK FORMS AN INTRINSICALLY SAFE SYSTEM WHEN ONE INDICATOR/REMOTE DISPLAY MODEL 8100I/8200IS IS CONNECTED TO ITS INTRINSICALLY SAFE OUTPUT CABLE AS SHOWN ABOVE, AND THE INDICATOR/REMOTE DISPLAY MODELS 8100I/8200IS ARE SUITABLE FOR USE IN HAZARDOUS AREAS AS SHOWN ON THIS CONTROL DRAWING NO. 900243. NO OTHER DEVICES ARE SUITABLE FOR DIRECT CONNECTION TO THE INTRINSICALLY SAFE OUTPUT CABLE OF MODEL 8B1S, AND THE ONLY ADDITIONAL DEVICES/CONFIGURATIONS THAT MAY BE CONNECTED TO THE INDICATOR/REMOTE DISPLAY MODELS 8100I/8200IS ARE SHOWN ON THIS CONTROL DRAWING NO. 900243.
- THE OUTPUT CURRENT OF THE MODEL 8B1S IS LIMITED BY A RESISTOR SUCH THAT THE OUTPUT VOLTAGE-CURRENT PLOT IS A STRAIGHT LINE DRAWN BETWEEN OPEN-CIRCUIT VOLTAGE AND SHORT-CIRCUIT CURRENT.
- MODEL 8BJX MUST BE INSTALLED IN AN ENCLOSURE SUITABLE FOR THE APPLICATION IN ACCORDANCE WITH THE NATIONAL ELECTRICAL CODE (ANSI/NFPA 70) FOR INSTALLATION IN THE UNITED STATES, THE CANADIAN ELECTRICAL CODE FOR INSTALLATIONS IN CANADA, OR OTHER LOCAL CODES, AS APPLICABLE.
- INTRINSICALLY SAFE CIRCUITS MUST BE WIRED AND SEPARATED IN ACCORDANCE WITH ARTICLE 504.20 OF THE NATIONAL ELECTRICAL CODE (ANSI/NFPA 70) OR OTHER LOCAL CODES, AS APPLICABLE.
- THIS BATTERY PACK MODEL 8B1S HAS NOT BEEN EVALUATED FOR USE IN COMBINATION WITH ANOTHER POWER SOURCE OR ASSOCIATED APPARATUS.
- THE INDICATOR/REMOTE DISPLAY MODEL 8100I/8200IS IS PROVIDED WITH A PERMANENTLY CONNECTED CABLE HAVING THE FOLLOWING CHARACTERISTICS:  
TURCK PART NO. RSM 30-2M UL/C-UL LISTED (E141522)  
RATED 300 V, 9 A, 105C  
3 WIRES, 18 AWG  
IP67 INGRESS PROTECTION  
MAXIMUM CAPACITANCE PER FOOT: 23.6 pF/ft  
MAXIMUM INDUCTANCE PER FOOT: 41.985 uH/ft  
MINIMUM CABLE JACKET INSULATION: 1.806 mm
- THE MODEL 8B1S IS PROVIDED WITH A PERMANENTLY CONNECTED CABLE HAVING THE FOLLOWING CHARACTERISTICS:  
TURCK PART NO. RKM 30-2M UL/C-UL LISTED (E141522)  
RATED 300 V, 9 A, 105C  
3 WIRES, 18 AWG  
IP67 INGRESS PROTECTION  
MAXIMUM CAPACITANCE PER FOOT: 23.6 pF/ft  
MAXIMUM INDUCTANCE PER FOOT: 41.985 uH/ft  
MINIMUM CABLE JACKET INSULATION: 1.806 mm
- SUITABILITY FOR INSTALLATION IN PARTICULAR APPLICATIONS IS AT THE DISCRETION OF THE AUTHORITY HAVING JURISDICTION (AHJ).
- THE OPTIONAL POWER EXTENSION CABLES WCB0234 AND WCB0235 MAY ONLY BE THE FOLLOWING TYPES IF USED:  
TURCK PART NO. P-RSM RKM 30-026-3M OR P-RSM RKM 30-026-6M  
UL/C-UL LISTED (E141522)  
RATED 300 V, 9 A, 105C  
3 WIRES, 18 AWG; AND 1 FOIL SHIELD, 20 AWG  
IP67 INGRESS PROTECTION  
MAXIMUM CAPACITANCE PER FOOT: 76.8 pF/ft  
MAXIMUM INDUCTANCE PER FOOT: 41.985 uH/ft  
MINIMUM CABLE JACKET INSULATION: 1.806 mm
- SUITABILITY FOR INSTALLATION IN PARTICULAR APPLICATIONS IS AT THE DISCRETION OF THE AUTHORITY HAVING JURISDICTION (AHJ).

## WARNING

READ AND UNDERSTAND COMPLETELY USER MANUAL NO. MAN0289 FOR THESE DEVICES BEFORE INSTALLATION OR OPERATION

**doran**<sup>®</sup> DORAN SCALES, INC.  
www.doranscales.com

## SYSTEM CONTROL DRAWING

DATE: 05/07/18	DRAWN BY: J.TORRES	DRAWING NUMBER 900243	SHEET NUMBER SHEET 5 OF 5	REV 02
-------------------	-----------------------	--------------------------	------------------------------	-----------

ECD #	REV	REVISIONS	DATE	APP
18-073	00	UL MARKUPS – NEW RELEASE	11/5/18	J.T
19-006	01	MORE UL MARKUPS	01/11/19	J.T
19-011	02	SEE SHEET 3	02/06/19	J.T

