

**Weighing Indicator**

# ***CI-2001A/B***

**OWNER'S MANUAL**





## **CONTENTS**

<b>PRECAUTIONS</b> .....	<b>4</b>
<b>INTRODUCTION</b> .....	<b>6</b>
<b>THE FEATURES OF CI-2001A/B</b> .....	<b>6</b>
<b>TECHNICAL SPECIFICATION</b> .....	<b>7</b>
<b>DIMENSIONS</b> .....	<b>8</b>
<b>FRONT PANEL (CI-2001A)</b> .....	<b>9</b>
<b>FRONT PANEL (CI-2001B)</b> .....	<b>11</b>
<b>REAR PANEL</b> .....	<b>13</b>
<b>INSTALLATION</b> .....	<b>14</b>
<b>TEST MODE</b> .....	<b>15</b>
<b>CALIBRATION MODE</b> .....	<b>18</b>
<b>SET MODE</b> .....	<b>21</b>
<b>SERIAL INTERFACE</b> .....	<b>25</b>
<b>ERROR MESSAGE AND TROUBLE SHOOTING</b> .....	<b>29</b>

## PRECAUTIONS

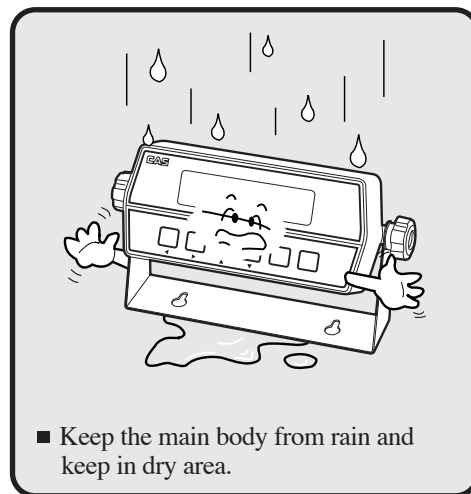
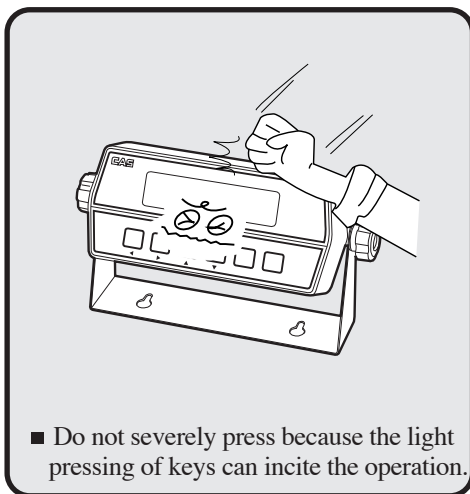
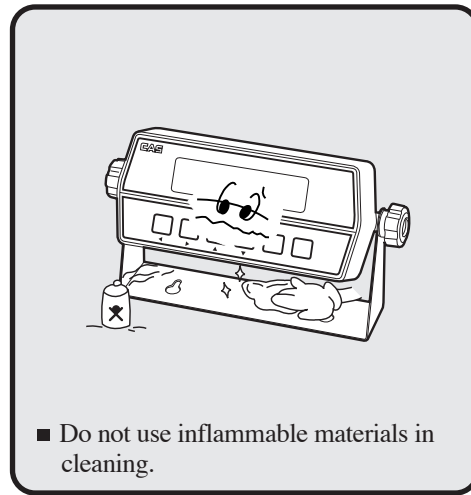
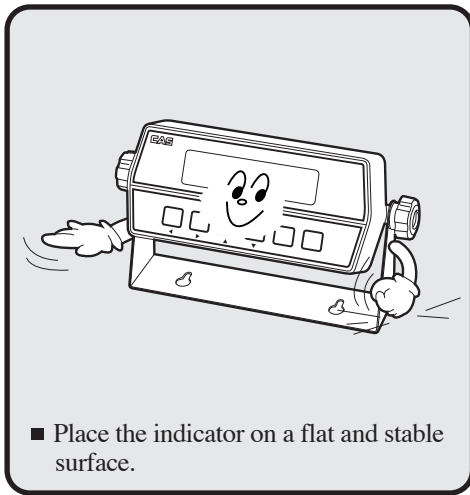

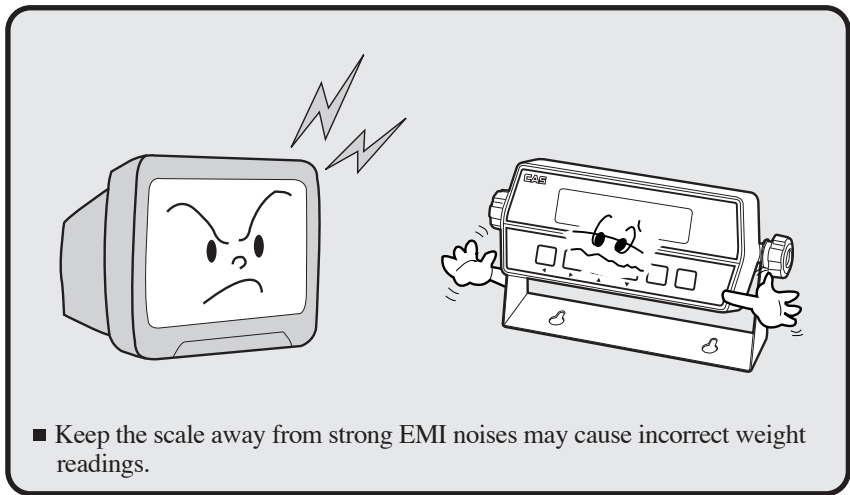
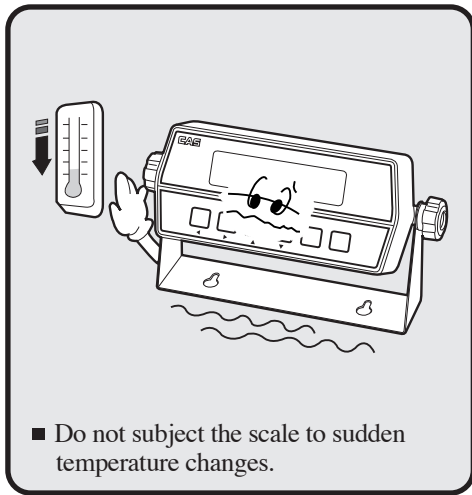



## INTRODUCTION

We greatly appreciate your purchase of the CAS industrial indicator. These goods perform excellently and exhibit splendid properties through strike tests.

CAS indicator (CI-series) is delicately designed to coincide with the special requirements of several industrial fields and includes many functions and various external interfaces. Also, it is programmed for the user's convenience and contains help display functions that are easily accessible.

Before using CI-2001A/B, It is recommended that you read this manual carefully so you may use this device to its full potential.

## THE FEATURES OF CI - 2001A/B

### 1. Features

- Appropriate for weight and measurement system.
- Easy operation and various options.
- Simple full digital calibration.  
(SPAC™ : single pass automatic span calibration)
- WATCHDOG circuitry (system restoration).
- Weight back-up (power on actual weight).
- Wall mount type (CI-2001A/B) - standard
- Panel mount type (CI-2001A/B(P)) - optional

### 2. Main Function

- Various specification of weight conversion speed. (Digital Filter Function)
- Various printer connection. (RS232 Serial printer - optional)
- Users can set the max. weight which users want to and division at one's disposal.
- Self hardware test.  
Prompt A/S is available for test of each part of the module.

## TECHNICAL SPECIFICATION

Analog Part	
Load cell excitation voltage	DC 5V, up to 4 × 350Ω load cells
Full scale input signal	20mV, including dead load
Zero adjust range	0.05mV ~ 5mV
Input sensitivity	2 μV/D (NTEP, OIML)
	0.5 μV/D (Non NTEP, OIML)
System linearity	Within 0.01% of FS
A/D internal resolution	Approximately 200,000 counts
A/D external resolution	5,000 dd (NTEP, OIML)
	30,000 dd (Non NTEP, OIML)
A/D conversion speed	10 times/sec

Digital Part	
Span calibration	Full Digital Calibration: SPAC™ (Single pass automatic span calibration)
Display	CI-2001A LED(6 digit)
	CI-2001B LCD(5 digit)
Size of letter	CI-2001A 14mm(Height)
	CI-2001B 25mm(Height)
Display below zero	"-" minus signal
Additional symbols	CI-2001A Zero, Tare, Gross, Net, Stable, lb, kg
	CI-2001B Zero, Net, Stable, lb, kg
AC adapter	AC 110V/220V(DC 12V, 850mA)
Power consumption	CI-2001A 10W
	CI-2001B 1W
Operating temperature	-10 C ~ +40 C
Overall dimensions	85mm × 186mm × 58mm
Weight	0.5kg

Option Part	
Standard	Serial Interface: RS-232
Option-1	Serial Interface: RS-422/485
Option-2	Panel Mount Bracket
Option-3	Inner Clock (only CI-2001B)

## DIMENSIONS

### 1. CI-2001A/B Wall Mount Type

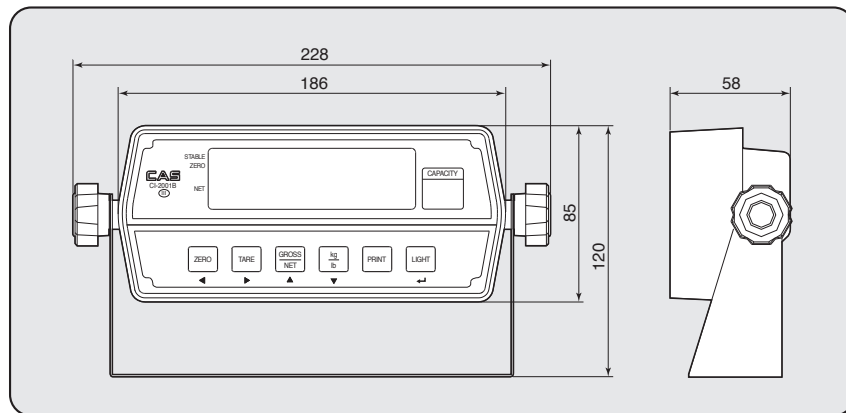

### 2. CI-2001A/B(P) Panel Mount Type

- Cutting Size: 166mm × 76mm

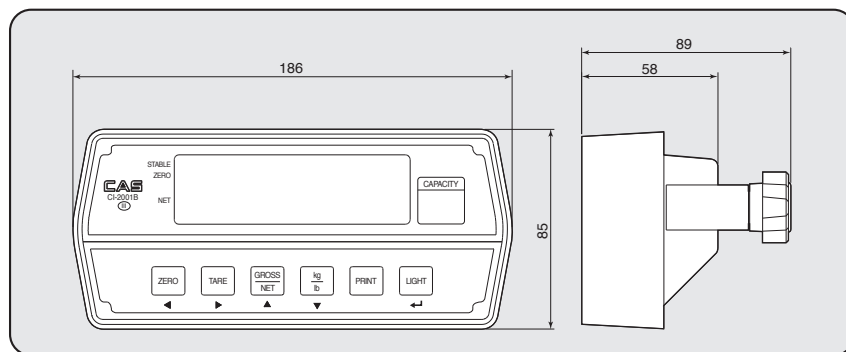

## FRONT PANEL(CI-2001A)

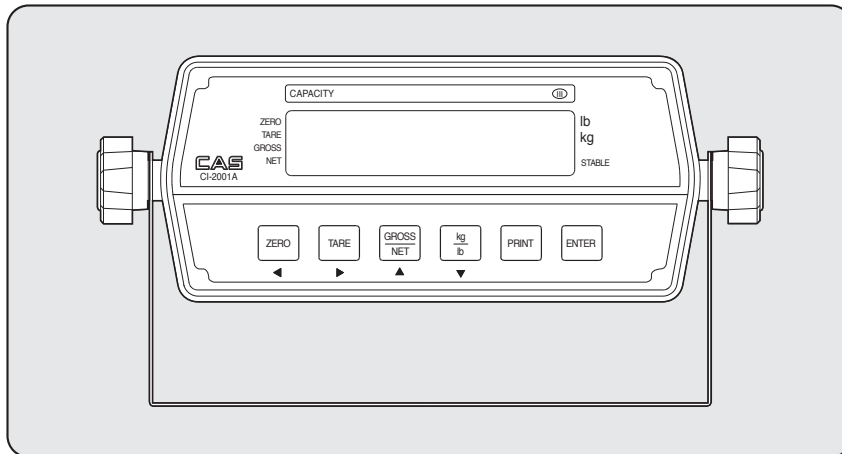

### 1. Display lamp(◀)

- lb lamp: ON when the weight unit is pound [lb]
- kg lamp: ON when the weight unit is kilogram [kg]
- STABLE lamp: ON when the weight is stable.
- TARE lamp: ON when the tare weight is stored.
- GROSS lamp: ON when the current weight is GROSS weight.
- NET lamp: ON when the current weight is NET weight.
- ZERO lamp: ON when the current weight is 0kg (0lb).

### 2. Keyboard

- ▲ ◀ Available keys instead of numeric keys.
  - ▲: Change the set value.  
Increase the first place value to 1.  
Usage-input the numeric value in TEST, CAL, SET mode.
  - ◀: Change the digit of the set value.  
Move to the left by 1 place.  
Usage-input the numeric value in TEST, CAL, SET mode.
- ZERO** Returns the display to 0.





#### TARE

- Use container in weighing.
- Current weight is memorized as tare weight.
- If you press TARE key in unload condition, Tare setting is released automatically.

#### GROSS/NET

- Use this key to switch from gross to net weight.  
GROSS lamp on - gross weight  
NET lamp on - net weight
- In case tare weight is REGISTERED, tare and item's total weight is G. weight and only item's weight is N. weight.

**kg/lb** Toggles between lb and kg units.

**PRINT** Used to print the present weighing value.

#### ENTER

- Total weighing value print key.
- HOLD key.  
In CALIBRATION, TEST, SET mode.  
: Store current condition and exit.
- Set in F09.

### 3. How to enter TEST mode

- Turn on the power while pressing the "PRINT" key and TEST mode starts.

### 4. How to enter SET mode

- Turn on the power while pressing the "ENTER(↵)" key and SET mode starts.

### 5. How to enter CAL mode

- Turn on the power while pressing the CAL switch on the rear panel of the indicator and CAL mode starts.

## FRONT PANEL(CI-2001B)

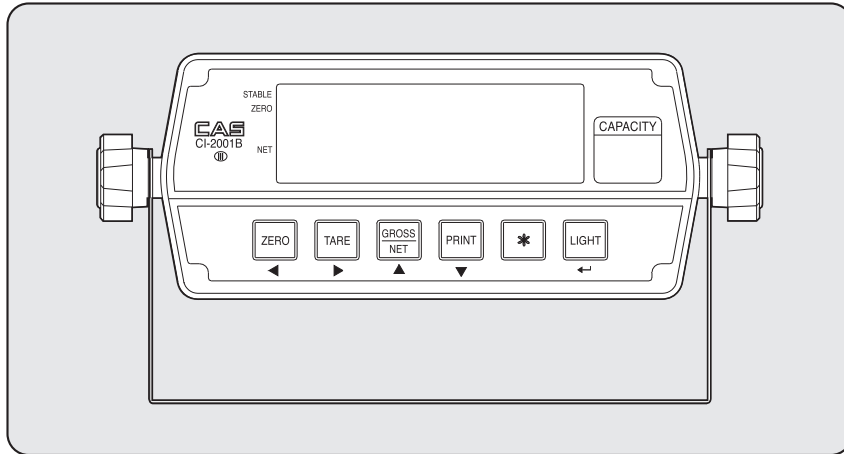

### 1. Display lamp(◀)

- lb lamp: ON when the weight unit is pound [lb]
- kg lamp: ON when the weight unit is kilogram [kg]
- STABLE lamp: ON when the weight is stable.
- ZERO lamp: ON when the current weight is 0kg (0lb).
- NET lamp: ON when the current weight is NET weight.

### 2. Keyboard

- ▲ ◀ Available keys instead of numeric keys.
  - ▲: Change the set value.
    - Increase the first place value to 1.
    - Usage-input the numeric value in TEST, CAL, SET mode.
  - ◀: Change the digit of the set value.
    - Move to the left by 1 place.
    - Usage-input the numeric value in TEST, CAL, SET mode.
- ZERO Returns the display to 0.



#### TARE

- Use container in weighing.
- Current weight is memorized as tare weight.
- If you press TARE key in unload condition, Tare setting is released automatically.

#### GROSS/NET

- Use this key to switch from gross to net weight.  
GROSS lamp on - gross weight  
NET lamp on - net weight
- In case tare weight is REGISTERED, tare and item's total weight is G. weight and only item's weight is N. weight.

**kg/lb** Toggles between lb and kg units.

#### PRINT

- PRINT key  
Total print key: print both the present weighing value and total weighing value (by pressing "PRINT" key more than 3 seconds)
- HOLD key  
Set in F08.

#### LIGHT(↵)

- In CALIBRATION, TEST, SET mode.  
: Store current condition and exit.

### 3. How to enter TEST mode

- Turn on the power while pressing the "PRINT" key and TEST mode starts.

### 4. How to enter SET mode

- Turn on the power while pressing the "LIGHT(↵)" key and SET mode starts.

### 5. How to enter CAL mode

- Turn on the power while pressing the CAL switch on the rear panel of the indicator and CAL mode starts.

## REAR PANEL

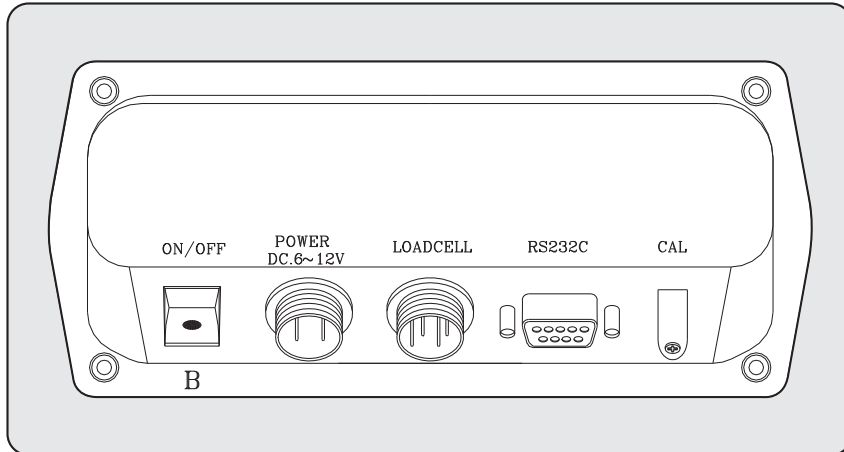

- RS-232C PORT: Serial interface port. (computer, printer)
- LOAD CELL: Port for connecting load cell.
- DC ADAPTER: Port for DC power.(DC 12V adapter are available)
- CAL S/W: Using in calibration starts.
- ON/OFF: Power ON/OFF switch.

### Legal seal installed

- Install the seal on the wire loop as shown in below figure.

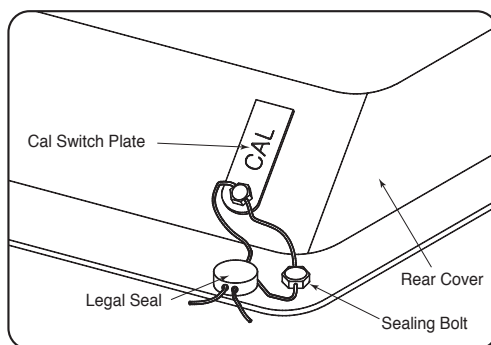

## INSTALLATION

### 1. Load Cell Connection

Connect load cell connector to load cell port which is in the backside of indicator.

#### ■ Connecting method

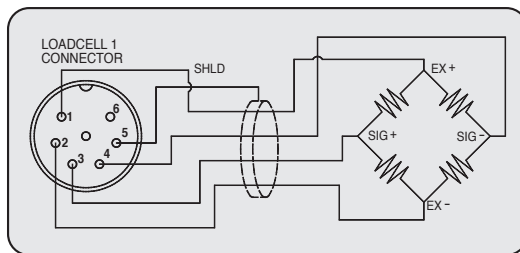

▶ Ref. Each L/C manufacturer's or model's wire color could be different. In that case, please note the following diagram on next page.

#### ■ Resolution to load cell output rate

Load cell Output voltage for 5V excitation voltage	Recommended resolution
2mV	1/1,000
4mV	1/2,000
10mV	1/5,000

#### ■ Manufacturer's wire colors

Connector Company	No. 1 (EX+)	No. 2 (EX-)	No. 3 (SIG+)	No. 4 (SIG-)	No.5 (SHIELD)
CAS	Red	White	Green	Blue	Shield
KYOWA	Red	Black	Green	White	Shield
INTERFACE	Red	Black	Green	White	Shield
P.T	Red	Black	Green	White	Shield
BLH	Green	Black	White	Red	Yellow
SHOWA	Red	Blue	White	Black	Shield
SHINKOH	Red	Black	Green	White	Shield
TMI	Red	White	Green	Blue	Yellow
TML	Red	Black	White	Green	Shield
TFAC	Red	Blue	White	Black	Yellow
HUNTLEIGH	Green	Black	Red	White	Shield



## TEST MODE

### 1. How to Enter

Turn on the power while pressing the "PRINT" key and TEST MODE starts.  
(CI-2001A/B kg/lb version)

Turn on the power while pressing the "\*" key and TEST MODE starts.  
(CI-2001A/B kg only version)

### 2. Available Keys

-  Increase the first place set value to 1.
-  Move to the left by 1 place of the set value.
- ENTER** Move into next test menu.(CI-2001A)
- LIGHT(↵)** Move into next test menu.(CI-2001B)

### 3. Test Menu(TEST 1 - TEST 5)

- TEST 1: Key test
- TEST 2: LCD display test
- TEST 3: Load cell test and A/D conversion test
- TEST 4: Serial Interface test(RS-232)
- TEST 5: Printer test

#### TEST 1

- Function: Key test

Key	Display	Description
LIGHT(↵): Move to next test other keys: perform test		TEST 1 condition. Press the key to be tested and the No, and code of the key is displays. Key mode should be identify with code of key like above.

<Key list>

CI-2001A		CI-2001B	
Key mode	Code	Key mode	Code
ZERO	1	ZERO	1
TARE	2	TARE	2
G/N	3	G/N	3
PRINT	4	kg/lb	4
*	5	PRINT	5

**TEST 2**

■ Function: LCD display test

Key	Display	Description
Displaying all lamps of key		TEST 2 condition. TEST 2 is performed automatically after 3 seconds or so.

▶ REF 1. Program is automatically shifted to Test 3 after completing Test 2.

**TEST 3**

■ Function: A/D converter test (L/C test)

Key	Display	Description
LIGHT(↵): Move to next test other keys: perform test		TEST 3 condition. Display digital value of current weight. This value means converted digital value.

▶ REF 1. A/D converter test is automatically completed by displaying converted digital value of current weight.

REF 2. L/C test is also completed by loading the weight on the platform.  
Check whether digital value is changing.

If the digital value is fixed or zero is displayed, please check the connection of the load cell.

## TEST 4

- Function: RS-232 test with computer

Key	Display	Description
ZERO: Transmit '1' TARE : Transmit '2' G/N : Transmit '3' kg/lb : Transmit '4' * : Transmit '5'	TEST 4	TEST 4 condition. Wait for transmission and reception.
LIGHT(↵): Next menu	0 - - - 1	Received: 1, Transmitted: none
	13 - - 0 1	Received: 1, Transmitted: 13

- ▶ REF 1. Do this test after the connection between serial port of computer and serial port of indicator.
- REF 2. Send No.1 in computer keyboard and check if indicator receives no.1.  
Send No.1 in indicator keyboard and check if computer receives no.1.
- REF 3. Do this test after baud rate is specified in SET mode(F11).

※ INDICATOR TEST(when it isn't connected with PC)

- 1)Connect directly between No.2(TXD) and No.3(RXD) in indicator of serial port.
- 2)If transmitting data is identical with receiving data by pressing key of front panel, this test will be done.

## TEST 5

- Function: Printer test

Key	Display	Description
LIGHT(↵): Exit test mode	TEST 5	TEST 5 condition.
other keys: perform test	GOOD	No error in printer.
	ERR 06	Check printer connector.

- ▶ REF 1. "GOOD" message is displayed if the printer connection and specification is done correctly. If or not, "ERROR 06" message is displayed.
- REF 2. The test output format of printer is like follows.

TEST OK

- If you press the enter key, it will be returned to NORMAL MODE.
- ▶ However, only when it is connected with printer, this test can be performed.





## CALIBRATION MODE

### 1. How to Enter

Turn on the power while pressing the CAL switch on the rear panel of the indicator and CAL mode starts.

### 2. Available Keys



-  Increase the first place set value to 1.
-  Move to the left by 1 place of the set value.
- PRINT** Initial('0') of the set value.(kg/lb version)
- \*** Initial('0') of the set value.(kg only version)
- ENTER** Move into next menu.(CI-2001A)
- LIGHT(↵)** Move into next menu.(CI-2001B)

### 3. Calibration Menu(CAL 1 - CAL 5)

- CAL 1: Maximum capacity Set
- CAL 2: Minimum division Set
- CAL 3: Setting weight in span calibration
- CAL 4: Zero Calibration
- CAL 5: Span Calibration

#### CAL 1

- Function: Maximum Capacity Set
- Range → 1 ~ 999,999kg/lb(CI-2001A)
- 1 ~ 99,999kg/lb(CI-2001B)

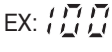

Key	Display	Description
▲ : Increase of no.		Program version.
◀ : Shift of digit		CAL 1 condition.
LIGHT(↵): Store and move into next menu	<b>Maximum Capacity Value</b> EX: 	100kg/lb

▶ REF 1. The maximum capacity means the maximum weight that scale can measure.

## CAL 2

### ■ Function: Minimum Division Set

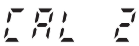
Range → 0.0005 ~ 100kg/lb

Key	Display	Description
▲ : Input the next ▼ division LIGHT(↵): Store and move into next menu	 <b>Minimum Division Value</b> EX: 	CAL 2 condition.  0.01kg/lb

▶ REF 1. The minimum division means the value of one division.



REF 2. External resolution is obtained by division the min. division by the maximum capacity. Set the resolution to be within 1/30,000.

## CAL 3

### ■ Function: Setting Weight In Span Calibration

Range → 1 ~ 999,999kg/lb(CI-2001A)

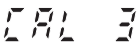
1 ~ 99,999kg/lb(CI-2001B)

Key	Display	Description
▲ : Increase of no. ◀ : Shift of digit LIGHT(↵): Store and move into next menu	 <b>Setting Weight</b> EX: 	CAL 3 condition.  100kg/lb

▶ REF 1. The weight shall be within the range of 10% ~ 100% of maximum weight.

REF 2. The setting weight must be over the range of 10% of maximum weight.  
If or not, error message ("ERR 22") will occur.

REF 3. If the setting weight over the maximum capacity, error message ("ERR 23") will occur.

## CAL 4

### ■ Function: Zero calibration

Key	Display	Description
LIGHT(↵): Zero calibration and move into next menu	CAL 4	CAL 4 condition.
	Unload	Unload the tray and press ENTER/LIGHT(↵) KEY
	converted digital value	
	checking 33333 indicator 22222 11111	Under zero calibration
	GOOD	Zero calibration is completed.

► REF 1. If zero calibration is done without any error, GOOD message is displayed and program moves into CAL 5 automatically.

REF 2. If the "ZERO" key is pressed, only zero calibration is completed and program moves SAVE & EXIT mode. Press ENTER/LIGHT(↵) key.

## CAL 5

### ■ Function: Span calibration

Key	Display	Description
LIGHT(↵): Span calibration and move into next menu	CAL 5	CAL 5 condition.
	Load	Load the weight which was set in CAL 3 and press LIGHT(↵).
	converted digital value	
	checking 33333 indicator 22222 11111	Under span calibration
	GOOD	Span calibration is completed.
	SAVE	Press LIGHT(↵) key. (Save & exit CAL mode)

► REF 1. If zero calibration is done without any error, GOOD message is displayed the weight of setting weight is displayed on LCD screen. Check the weight.

REF 2. If the span value is low. Error message (ERR 24) is displayed. Calibrate with lower resolution.





## SET MODE

### 1. How to Enter

Turn on the power while pressing the LIGHT(↵) key and SET Mode starts.  
(CI-2001B)

Turn on the power while pressing the ENTER(↵) key and SET Mode starts.  
(CI-2001A)

### 2. Available Keys

-  Increase the first place set value to 1.
-  Move to the left by 1 place of the set value.
-  Move into next menu.(CI-2001A)
-  Move into next menu.(CI-2001B)

### 3. Set Value Conversion Menu(F01 - F14)

- F01 Select the primary base unit (only kg/lb version)
- F02 Designation of serial port usage
- F03 Automatic zero tracking compensation
- F04 Digital filter
- F07 Weight back-up (power-on actual weight)
- F08 "\*" key usage(CI-2001A kg version)
- F08 "PRINT" key usage (CI-2001B kg/lb version)
- F09 "ENTER" key usage (CI-2001A kg version)
- F09 "\*" key usage (CI-2001B kg version)
- F10 Device ID
- F11 Designation of serial interface baud rate
- F12 Designation of serial interface output mode
- F13 Set HOLD type
- F14 Select of clock option (only CI-2001B)

Select the primary base unit		
<b>F01</b>	0	Primary unit is kg
	1	Primary unit is lb

Serial port usage		
<b>F02</b>	0	Connection with computer and sub-display (CD-3000A)
	1	Connection with serial printer

Automatic zero tracking			
<b>F03</b>	0	None automatic zero	Autozero tracking will automatically bring the display back to "0" when there are small deviations.
	1	1 : 0.5 division	
	~ 9	9 : 4.5 division	

Digital filter			
<b>F04</b>	0	None automatic zero	Adjust the set value according to the condition how many times converted digital value read and display.
	1	1 : Less vibration	
	~ 9	9 : Much vibration	

Select the weight back-up mode		
<b>F07</b>	0	Weight back-up is off (Power on zero)
	1	Weight back-up is on (Display setting weight)

"*" key usage (CI-2001A kg version)		
<b>F08</b>	0	Not used
	1	Total print key

"PRINT" key usage (CI-2001B kg/lb version)		
<b>F08</b>	0	Not used
	1	- Print key (Press "PRINT" key) - Total print key (by pressing "PRINT" key more than 3 second)
	2	HOLD key

"ENTER" key usage (CI-2001A kg version)		
<b>F09</b>	0	Not used
	1	Total print key
	2	HOLD key

"*" key usage (CI-2001B kg version)		
<b>F09</b>	0	Not used
	1	Total print key
	2	HOLD key

Device ID			
<b>F10</b>	00	00 : Device ID "00" (setting when it isn't connected with system)	It is used the no. of indicator when system is connected.
	~		
	99	99 : Device ID "99"	

Baud rate (unit of speed in data transmission)		
<b>F11</b>	0	600 bps (bit per second)
	1	1200 bps
	2	2400 bps
	3	4800 bps
	4	9600 bps
	5	19200 bps



Output mode (setting how to transmit to external equipment)			
<b>F12</b>	0	In case selecting No.1 of F02, this function must be set up.	No data output
	1	In case selecting No.0 of F02, these keys can be set up.	Stream mode
	2		Transmit only in stable condition
	3		Transmit when data is required → Request signal : device ID (F10 : Device ID) → In case F10 : 1, send hex value 01h in computer

Set HOLD type (only in case setting hold key)		
<b>F13</b>	0	Average hold: Compute the average weight of oscillating weights.
	1	Peak hold: Compute the maximum weight among oscillating weights.

Select option clock		
<b>F14</b>	0	Not use clock
	1	Use clock

Change date/time (Ex. 1998/12/11 13:10:01)		
▲ : Increase of no. ◀ : Shift of digit LIGHT(↵): Store and move into next menu	LCD Display	Meaning
	C1 98	Year : 98
	C2 12	Month : 12
	C3 11	Day : 11
	C4 13	Hour : 13
	C5 10	Minute : 10
	C6 01	Second : 01

## SERIAL INTERFACE

### OP-1 RS232C Serial Interface (COM1)

#### ■ RS232C Port Connection

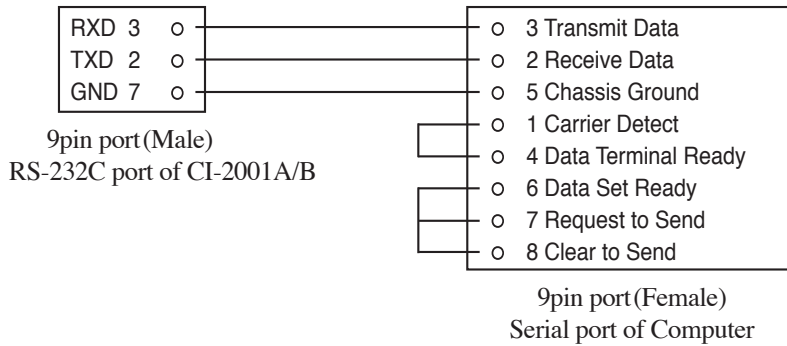
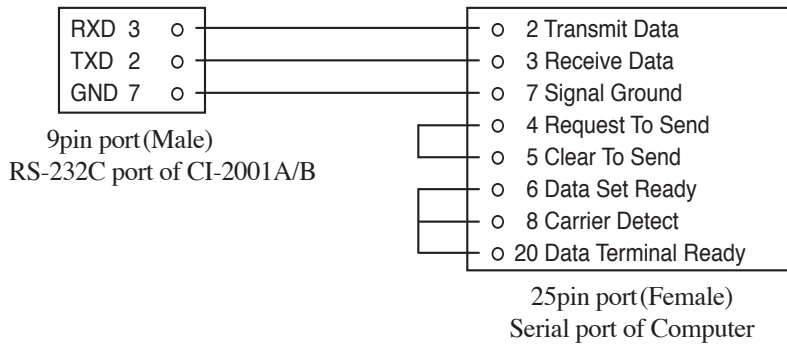

#### ■ Sub-display Connection

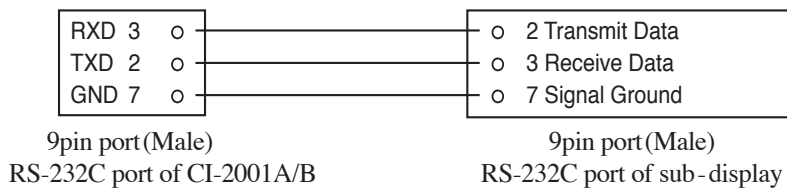





■ Data Format

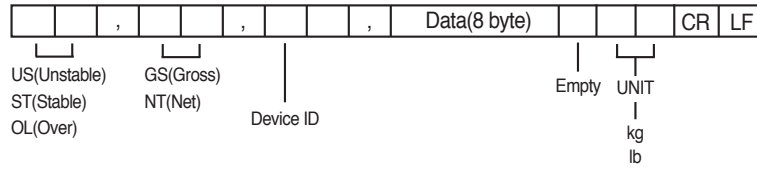

▶ Device ID

Transmit 1 byte device ID so that the receiver can receive data selectively which indicator send.

▶ Weight data(8 byte)

1. 13.5 kg : '0','0','0','0','1','3','.', '5'
2. 135 kg : '0','0','0','0','1','3','5','0'
3. -135 kg : '-','0','0','0','0','3','5','0'

Each ASCII code of weight transmitted by 8 byte.( '0' : 0 × 20)

■ Simple Interface Program(GWBASIC Language)

```

10 OPEN "COM1:9600,N,8,1" As #1
20 IF LOC(1) = 0 THEN 60
30 A$ = INPUT$(1,1)
40 PRINT A$ ; " ";
50 GOTO 20
60 B$=INKEY$ : IF B$ =" " THEN 20
70 PRINT B$ ; " ";
80 PRINT #1,B$;
90 GOTO 20

```

■ Simple Interface Program(GWBASIC Language)

```
#include <bios.h>
#include <conio.h>
#define COM1      0
#define DATA_READY 0x100
#define TRUE      1
#define FALSE     0
#define SETTINGS  0x0E3

int main(void)
{
    int in, out, status, DONE = FALSE;

    bioscom(0, SETTINGS, COM1);
    printf("... BIOSCOM [ESC] to exit ...%n");
    while (!DONE)
    {
        status = bioscom(3, 0, COM1);
        if (status & DATA_READY)
            if ((out = bioscom(2, 0, COM1) & 0x7F) != 0)
                putchar(out);
        if (kbhit())
        {
            if ((in = getch()) == '\x1B')
                DONE = TRUE;
            bioscom(1, in, COM1);
        }
    }
    return 0;
}
```

■ CP-7000 Series Printer Connection

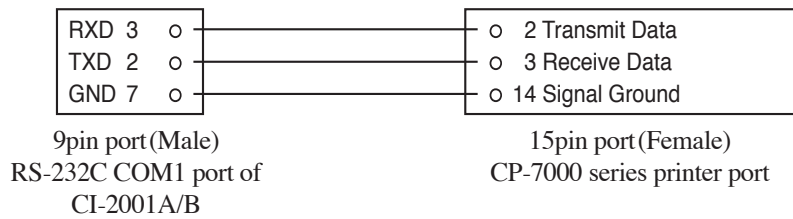

■ ND Series Serial Printer Connection

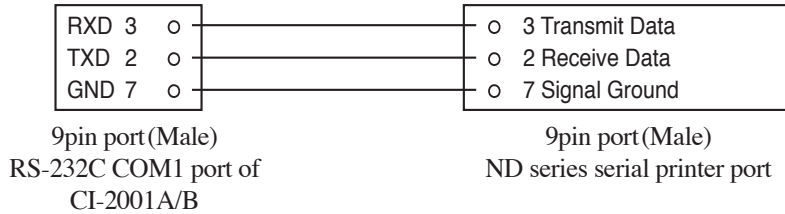

**SPECIAL** | **RS-422/485 Serial Interface (COM1)**

- Transmit mode: Same as RS-232C interface COM1
- Data format: Same as RS-232C interface COM1
- Connecting method of RS-485 Port

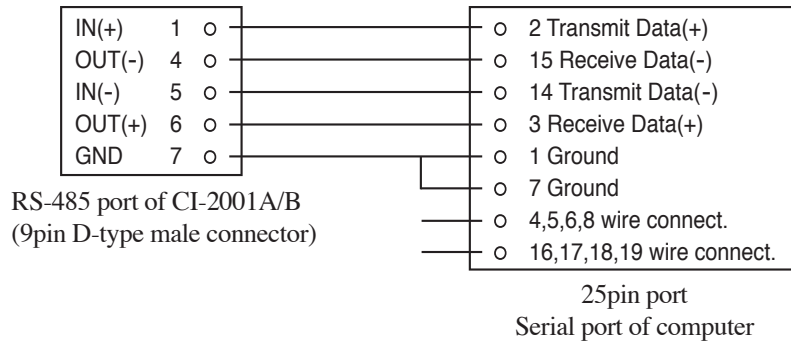

■ Connecting method of RS-485 Remote Sub Display

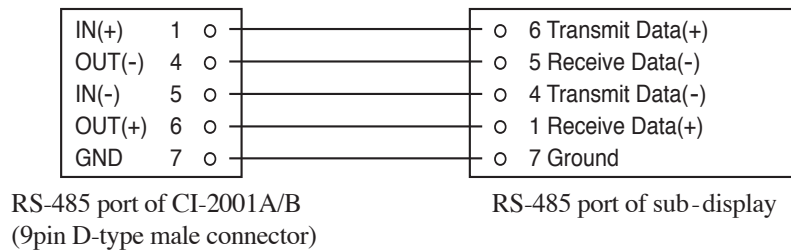

## ERROR MESSAGE AND TROUBLE SHOOTING

### 1. Error in Weighing Mode

#### Err 02

- Reason: Failure in load cell connection or error in A/D conversion part.
- Trouble shooting: Check the load cell connector so that you may see if the polarity of signal is reversed.

#### Err 06

- Reason: Error in printer connection
- Trouble shooting: Check with printer connector.  
If there is no problem with printer and printer connector, please request A/S to head office.

#### Err 08

- Reason: The ZERO key or TARE key is adjusted not to be operated under the unstable condition.
- Trouble shooting: Press ZERO or TARE key in stable condition.

#### Err 09

- Reason: Current weight deviates from zero range.
- Trouble shooting: Press the ZERO key within 10% of the maximum capacity.

#### Err 10

- Reason: Tare weight exceeds the maximum capacity of the scale.
- Trouble shooting: Set the tare to be smaller than the maximum capacity.  
Otherwise the maximum capacity is reset to be larger than the tare to be set in the calibration menu, and reset the calibration using weight.

#### Err 13

- Reason: The zero range deviates from the set range.
- Trouble shooting: Confirm that there is nothing on the weighing platform.  
If there were nothing, do calibration on CAL mode.

#### Over

- Reason: The weight on platform is too heavy to be measured.
- Trouble shooting: Do not load the item exceeds the maximum tolerance.  
If the load cell is damaged, the load cell should be replaced.

## 2. Errors in Calibration Mode

### Err 21

- Reason: The resolution is set to be exceeded the limit 1/10,000.
- Trouble shooting: Lower the resolution.  
The resolution = allowed weight/one division  
Modify the allowed weight in CAL 1 or modify the division in CAL 2 so that the resolution should be below 1/10,000.

### Err 22

- Reason: The weight for span calibration is set to be lower than 10% of the maximum capacity of the scale.
- Trouble shooting: Set the weight for span calibration in CAL 3 to be more than 10% of the maximum capacity.

### Err 23

- Reason: The weight for span calibration is set to be exceeded 100% of the maximum capacity of the scale.
- Trouble shooting: Set the weight for span calibration to be within the maximum capacity of the scale in CAL 1.

### Err 24

- Reason: The load cell output is too low at SPAN calibration.
- Trouble shooting: Setting of current resolution is not possible due to the error in load cell.  
Proceed calibration again with less resolution.

Load Cell Output Voltage for 5V Excitation Voltage	Recommended Resolution
2mV	1/1,000
4mV	1/2,000
10mV	1/5,000

### Err 25

- Reason: The load cell output is too high at SPAN calibration.
- Trouble shooting: Setting of current resolution is not possible due to the error in load cell.  
Proceed calibration again with less resolution.

**Err 26**

- Reason: The load cell output is too high at ZERO calibration.
- Trouble shooting: Check if the platform empty.  
Proceed calibration again after checking in A/D TEST mode.



# CI-2001AS/BS





## **CONTENTS**

**PRECAUTIONS ..... 4**

**INTRODUCTION ..... 6**

**THE FEATURES OF CI-2001AS/CI-2001BS ..... 6**

**TECHNICAL SPECIFICATION ..... 7**

**DIMENSIONS ..... 8**

**FRONT PANEL(CI-2001AS) ..... 9**

**FRONT PANEL(CI-2001BS) ..... 11**

**CONNECTING THE CABLE ..... 13**

**TEST MODE ..... 14**

**CALIBRATION MODE ..... 17**

**SET MODE ..... 20**

**SERIAL INTERFACE ..... 24**

**ERROR MESSAGE & TROUBLE SHOOTING ..... 28**



# PRECAUTIONS

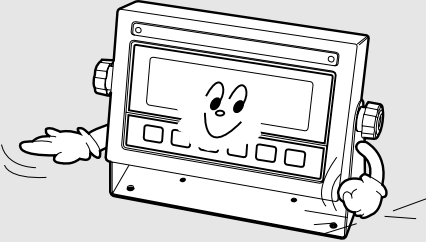

- Place the indicator on a flat and stable surface.

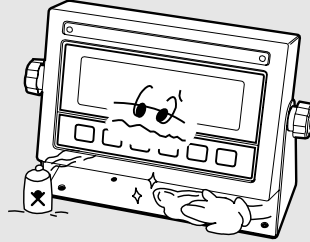

- Do not use inflammable materials in cleaning.

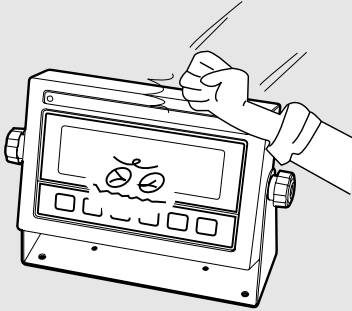

- Do not severely press because the light pressing of keys can incite the operation.

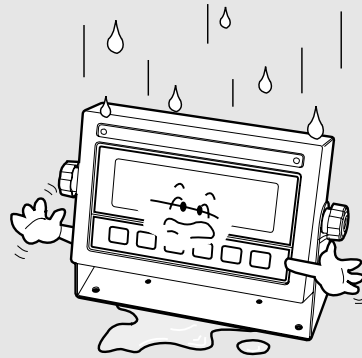

- Keep the main body from rain and keep in dry area.

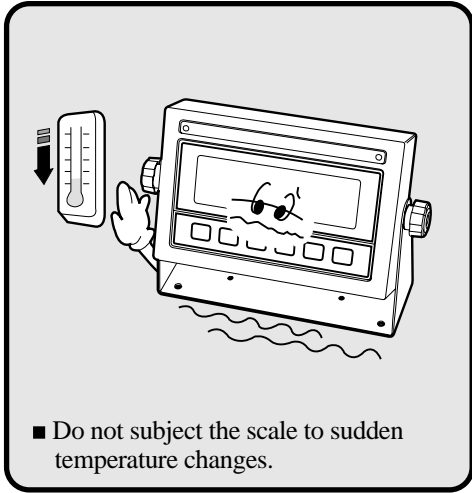

■ Do not subject the scale to sudden temperature changes.

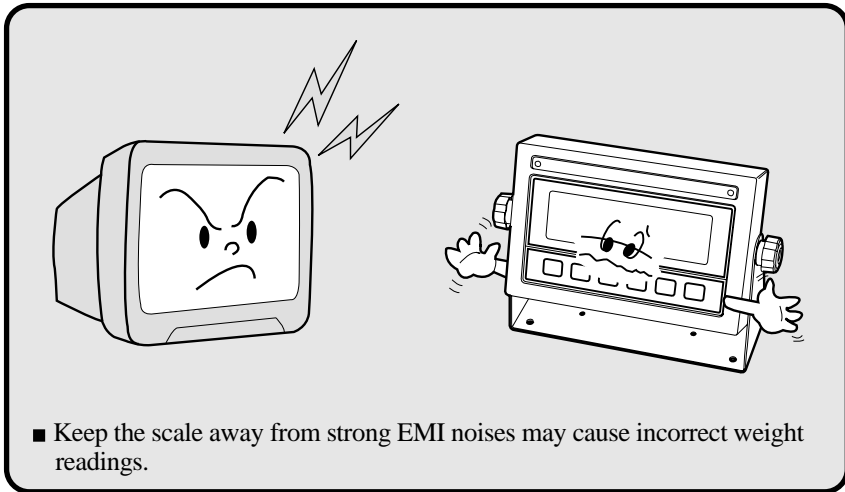

■ Keep the scale away from strong EMI noises may cause incorrect weight readings.

## INTRODUCTION

We greatly appreciate your purchase of the CAS industrial indicator. These goods have hold excellent performance and splendid properties through strike tests as well as devoting ourselves under severe quality management.

CAS indicator(CI-series) is shaped firmly and delicately designed a coincide with the special requirements of several industrial fields and includes many functions and various external interfaces. Also, it is programmed on the basic of the user's convenience and contains help display functions to be used easily.

Before using CI-2001AS/BS, It is recommended to read this manual carefully and to apply the function application fully.

## THE FEATURES OF CI-2001AS/CI-2001BS

### 1. Features

- Appropriate for weight and measurement system
- Easy operation and various functions
- Simple full digital calibration  
(SPAC™:Single pass automatic span calibration)
- Watchdog circuitry(System restoration)
- Wall mount type(CI-2001AS/BS)-Standard

### 2. Main Function

- Various specification of weight conversion speed(Digital filter function)
- Various printer connection(RS232 Serial printer)
- Users can set the desirous max. weight and a division freely
- Self hardware test  
Prompt A/S is available for test of each part of circuit by module is possible

## TECHNICAL SPECIFICATION

Analog Part	
Load cell excitation voltage	DC 5V, up to 4 × 350g load cells
Full scale input signal	20mV, including dead load
Zero adjust range	0.05mV ~ 5mV
Input sensitivity	2 $\mu$ V/D (H-44, OIML) 0.5 $\mu$ V/D (Non H-44, OIML)
System linearity	Within 0.01% of FS
A/D internal resolution	Approximately 200,000 counts
A/D external resolution	5,000dd (H-44, OIML) 30,000dd (Non H-44, OIML)
A/D conversion speed	10 times/sec

Digital Part	
Span calibration	Full Digital Calibration: SPAC™ (Single pass automatic span calibration)
Display	CI-2001AS LED(6 digit)
	CI-2001BS LCD(5 digit)
Size of letter	CI-2001AS 25mm(Height)
	CI-2001BS 25mm(Height)
Display below zero	"-" minus signal
Additional symbols	CI-2001AS Zero, Tare, Gross, Net, Stable
	CI-2001BS Zero, Net, Stable
AC adapter	AC 110V/220V, 50/60Hz (DC 12V, 500mA)
Power consumption	CI-2001AS 10W
	CI-2001BS 1W
Operating temperature	-10°C ~ +40°C
Overall dimensions	200mm × 130mm × 53mm
Weight	2kg

Option Part	
Option-1	Serial Interface: RS-422/485
Option-2	Inner Clock
Option-3	Built in Battery

## DIMENSIONS

### CI-2001AS/BS Wall Mount Type

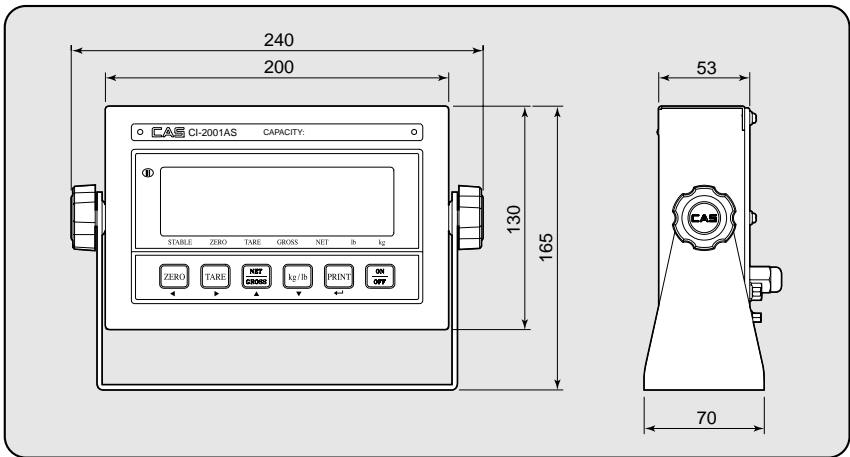

## FRONT PANEL (CI-2001AS)

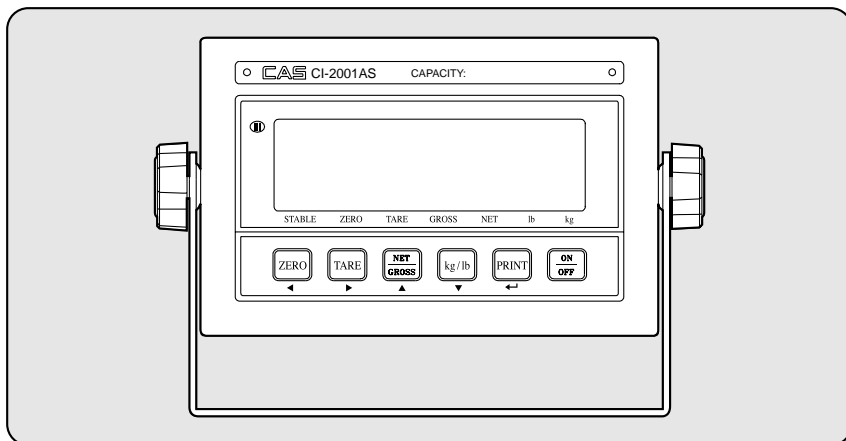

### 1. Display Lamp (■)

- STABLE lamp: ON when the weight is stable.
- GROSS lamp: ON when the current weight is GROSS weight.
- NET lamp: ON when the current weight is NET weight.
- TARE lamp: ON when the tare weight is stored.
- ZERO lamp: ON when the current weight is 0kg (0lb).

### 2. Keyboard

▲ ◀ Available keys instead of numeric keys.

▲: Change the set value

Increase the first place value to 1

◀: Change the digit of the set value

Move to the left by 1 place

USAGE: Input the numeral value in TEST, CAL, SET mode.

**ZERO** Return the display to 0.

**TARE**

Use container in weighing.

Current weight is memorized as tare weight.

If you press TARE key in unload condition, tare setting is released.

## **GROSS/NET**

Display gross and net weight by turn.

GROSS lamp on - gross weight

NET lamp on - net weight

In case tare weight is REGISTERED, tare and item's total weight is G. weight and only item's weight is N. weight.

## **PRINT** (CI-2001AS kg only version)

- PRINT key
- Total Print key  
(by pressing "PTINT" key more than 3 second.)

## **kg/lb** (CI-2001AS kg/lb conversion version)

Toggles between lb and kg units

## **ENTER**

- PRINT key (CI-2001AS kg only version)
  - Total Print key  
(by pressing "PRINT" key more than 3 second.)
- Total PRINT key (CI-2001AS kg/lb conversion version)
- HOLD key
- In CALIBRATION, TEST, SET mode.
  - : Store current condition and exit.

### **3. How to enter TEST mode**

- Press the "On/Off" key while pressing the "PRINT" key and TEST mode starts. (CI-2001AS kg only version)
- Press the "On/Off" key while pressing the "kg/lb" key and TEST mode starts. (CI-2001AS kg/lb conversion version)

### **4. How to enter SET mode**

- Press the "On/Off" key while pressing the "ENTER" key and SET mode starts.

### **5. How to enter CAL mode**

- Press the "On/Off" key while pressing the CAL switch on the rear panel of the indicator and CAL mode starts.

## FRONT PANEL (CI-2001BS)

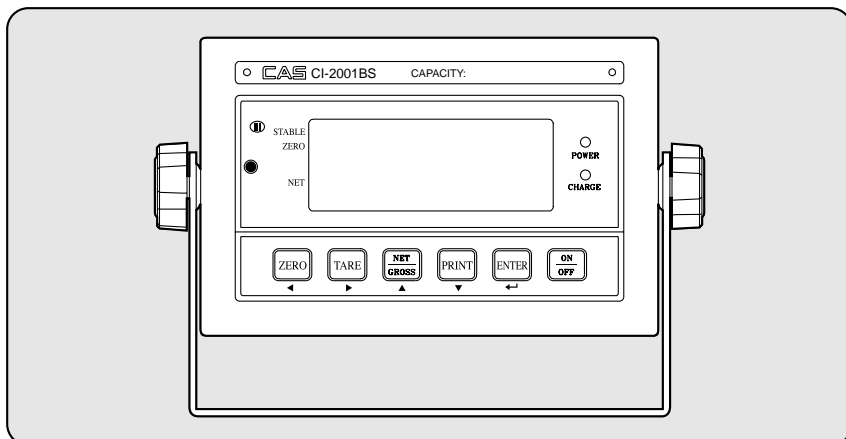

### 1. Display Lamp (■)

- kg lamp: ON when the weight unit is kilogram [kg].
- lb lamp: ON when the weight unit is pound [lb].
- STABLE lamp: ON when the weight is stable.
- NET lamp: ON when the current weight is NET weight.
- ZERO lamp: ON when the current weight is 0kg (0lb).

### 2. Keyboard

▲ ◀ Available keys instead of numeric keys.

▲: Change the set value

Increase the first place value to 1

◀: Change the digit of the set value

Move to the left by 1 place

USAGE: Input the numeral value in TEST, CAL, SET mode.

**ZERO** Return the display to 0.

**TARE**

Use container in weighing.

Current weight is memorized as tare weight.

If you press TARE key in unload condition, tare setting is released.



## **GROSS/NET**

Display gross and net weight by turn.

GROSS lamp on - gross weight

NET lamp on - net weight

In case tare weight is REGISTERED, tare and item's total weight is G. weight and only item's weight is N. weight.

## **PRINT** (CI-2001BS kg only version)

- PRINT key
- Total Print key  
(by pressing "PTINT" key more than 3 second.)

## **kg/lb** (CI-2001BS kg/lb conversion version)

Toggles between lb and kg units

## **ENTER**

- PRINT key (CI-2001BS kg only version)
  - Total Print key  
(by pressing "PRINT" key more than 3 second.)
- Total PRINT key (CI-2001BS kg/lb conversion version)
- HOLD key
- LCD manual back light key
- In CALIBRATION, TEST, SET mode.
  - : Store current condition and exit.

### 3. How to enter TEST mode

- Press the "On/Off" key while pressing the "PRINT" key and TEST mode starts. (CI-2001BS kg only version)
- Press the "On/Off" key while pressing the "kg/lb" key and TEST mode starts. (CI-2001BS kg/lb conversion version)

### 4. How to enter SET mode

- Press the "On/Off" key while pressing the "ENTER" key and SET mode starts.

### 5. How to enter CAL mode

- Press the "On/Off" key while pressing the CAL switch on the rear panel of the indicator and CAL mode starts.

## CONNECTING THE CABLE

- DC ADAPTER (0V, +12V): Port for DC power.  
→ DC 12V adapter is available
- RS-485 Interface (485\_SIG+, 485\_SIG-):  
Serial interface port. (Computer ...)
- RS-232 Interface (232\_RXD, 232\_TXD, GND):  
Serial interface port. (Computer, Printer, Remote Display)
- LOAD CELL (Ex+, Ex-, Sig+, Sig-, GND):  
Port for connecting load cell.

### Legal seal installed

- Install the seal on the wire loop as shown in below figure.

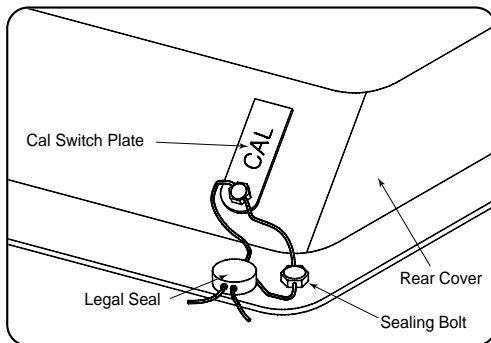

# TEST MODE

## 1. How to Enter

Press the power while pressing the “PRINT” key and TEST menu starts.  
(CI-2001AS/BS kg only version)

Press the power while pressing the “kg/lb” key and TEST menu starts.  
(CI-2001AS/BS kg/lb conversion version)

## 2. Available Keys

 Increase the first place set value to 1.

 Move to the left by 1 place of the set value.

 Initial('0') of the set value. (CI-2001AS/BS kg type)

 Initial('0') of the set value. (CI-2001AS/BS kg/lb)

 Move into next menu.

## 3. TEST Menu(TEST 1 - TEST 5)

TEST 1 : Key test

TEST 2 : LED/LCD display test

TEST 3 : Load cell test and A/D conversion test

TEST 4 : Serial interface test(RS-232)

TEST 5 : Printer test

### TEST 1

- Function: Key test

Key	Display	Description
ENTER: Next menu Other keys: Perform test		TEST 1 condition. Press the key to be tested and the No, and code of the key is displays. Key mode should be identify with code of key like above.

<Key list>

CI-2001AS/BS kg only version		CI-2001AS/BS kg/lb version	
Key	Code	Key	Code
ZERO	2	ZERO	2
TARE	3	TARE	3
G/N	4	G/N	4
PRINT	5	kg/lb	5
ENTER	6	ENTER	6

## TEST 2

### ■ Function: LED/LCD display test

Key	Display	Description
Displaying all lamps of key		<p>TEST 2 condition.</p> <p>TEST 2 is performed automatically after 3 seconds or so.</p>

▶REF 1. Program is automatically shifted to test 3 after completing Test 2.

## TEST 3

### ■ Function: A/D converter test (L/C test)

Key	Display	Description
<p>ENTER: Next menu</p> <p>Other keys: Perform test</p>		<p>TEST 3 condition.</p> <p>Display digital value of current weight. This value means converted digital value.</p>

▶REF 1. A/D converter test is automatically completed by displaying converted digital value of current weight.

REF 2. L/C test is also completed by loading the weight on the platform.

Check whether digital value is changing.

If the digital value is fixed or zero is displayed, please check the connection of the load cell.

## TEST 4

### ■ Function: RS-232 test with computer

Key	Display	Description
ZERO: Transmit '1'	TEST 4	TEST 4 condition.
TARE: Transmit '2'	0 - - - 0	Wait for transmission and reception.
G/N: Transmit '3'	0 - - - 1	Receive: 1, Transmit: none
PRINT: Transmit '4'	0 - - - 1	Receive: 1, Transmit: none
ENTER: Next menu	13 - - 01	Receive: 1, Transmit: 13

▶ REF 1. Do this test after the connection between serial port of computer and serial port of indicator.

REF 2. Send No.1 in computer keyboard and check if indicator receives No.1.  
Send No.1 in indicator keyboard and check if computer receives No.1.

REF 3. Do this test after baud rate is specified in SET mode(F11).

※ INDICATOR TEST (when it isn't connected with PC)

- 1) Connect directly between No.2(TXD) and No.3(RXD) in indicator of serial port.
- 2) If transmitting data is identical with receiving data by pressing key of front panel, this test will be done.

## TEST 5

### ■ Function: Printer test

Key	Display	Description
ENTER: Exit test mode	TEST 5	TEST 5 condition.
Other keys: Perform test	GOOD	No error in printer.
	ERR 06	Check printer connector.

▶ REF 1. "GOOD" message is displayed if the printer connection and specification is done correctly. If or not, "ERR 06" message is displayed.

REF 2. The test output format of printer is like follows.

**TEST OK**

If you press the enter key, it will be returned to NORMAL MODE.



However, only when it is connected with printer, this test can be performed.

# CALIBRATION MODE

## 1. How to Enter

Press the power while pressing the CAL switch on the rear panel of the indicator and CAL mode starts.

## 2. Available Keys

-  Increase the first place set value to 1.
-  Move to the left by 1 place of the set value.
- PRINT** Initial ('0') of the set value. (CI-2001AS/BS kg type)
- kg/lb** Initial ('0') of the set value. (CI-2001AS/BS kg/lb)
- ENTER(↵)** Move into next menu.

## 3. CALIBRATION Menu(CAL 1 - CAL 5)

CAL 1 : Maximum capacity

CAL 2 : Minimum division

CAL 3 : Setting weight

CAL 4 : Zero calibration

CAL 5 : Span calibration

### CAL 1

- Function: Maximum capacity set  
 Range → 1 ~ 999,999 kg/lb (CI-2001AS)  
 1 ~ 99,999 kg/lb (CI-2001BS)

Key	Display	Description
▲: Increase of no.	2 05	Program version.
◀: Shift of digit	CAL 1	CAL 1 condition.
ENTER: Store and move into next menu	100 Maximum capacity value	100kg (lb)

▶REF 1. The maximum capacity means the maximum weight that scale can measure.

## CAL 2

- Function: Minimum division set

Range → 0.0005 ~ 100kg/lb

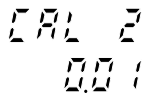
Key	Display	Description
▲: Input the next division ENTER: Store and move into next menu	 Minimum division value	CAL 1 condition. 0.01 kg (lb)

- ▶ REF 1. The minimum division means the value of one division.

REF 2. External resolution is obtained by division the min. division by the maximum capacity. Set the resolution to be within 1/30,000.

## CAL 3

- Function: Setting weight in span calibration

Range → 1 ~ 999,999kg/lb(CI-2001AS)

1 ~ 99,999kg/lb(CI-2001BS)

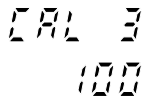
Key	Display	Description
▲: Increase of no. ◀: Shift of digit ENTER: Store and move into next menu	 Setting weight	CAL 3 condition. 100kg (lb)

- ▶ REF 1. The weight shall be within the range of 1% ~ 100% of maximum weight.

REF 2. If the setting weight is under the 1% of the maximum capacity.  
Error message("ERR 22") will occur.

REF 3. If the setting weight over the maximum capacity.  
Error message("ERR 23") will occur.

## CAL 4

### ■ Function: Zero calibration

Key	Display	Description
ENTER: Zero calibration and move into next menu	CAL 4	CAL 4 condition.
	UnLoad	Unload the tray and press ENTER.
	- - - - -	Under zero calibration.
	Good	Zero calibration is completed.

► REF 1. If zero calibration is done without any error, GOOD message is displayed and program moves into CAL 5 automatically.

REF 2. If the “ZERO” key is press, only zero calibration is completed and program moves SAVE & EXIT mode. Press ENTER key.

## CAL 5

### ■ Function: Span calibration

Key	Display	Description
ENTER: Span calibration and move into next menu	CAL 5	CAL 5 condition.
	Load	Load the weight which was set in CAL 3 and press ENTER.
	- - - - -	Under span calibration.
	Good	Span calibration is completed.
		Remove the setting weight. Press the “ENTER” key to save the value.

► REF 1. If span calibration is done without any error, GOOD message is displayed the weight of setting weight is displayed on display screen.  
Check the weight.

REF 2. If the span is low, error message (ERR 24) is displayed.  
Calibrate with lower resolution.

REF 3. After setting the exact value, remove the setting weight and press the “ENTER” key to save the value.







# SET MODE

## 1. How to Enter

Turn on the power while pressing the “ENTER” key and SET menu starts.

## 2. Available Keys

-  Increase the first place set value to 1.
-  Move to the left by 1 place of the set value.
-  Initial ('0') of the set value. (CI-2001AS/BS kg type)
-  Initial ('0') of the set value. (CI-2001AS/BS kg/lb)
-  Move into next menu.

## 3. Set Value Conversion Menu (F01 - F14)

- F01 : Select the primary base unit (kg/lb type)
- F02 : Designation of serial port usage
- F03 : Automatic zero tracking compensation
- F04 : Digital filter
- F07 : Weight back-up (power-on actual weight)
- F09 : “ENTER” key usage (CI-2001AS kg type)
- F09 : “ENTER” key usage (CI-2001AS kg/lb type)
- F09 : “ENTER” key usage (CI-2001BS kg type)
- F09 : “ENTER” key usage (CI-2001BS kg/lb type)
- F10 : Device ID
- F11 : Designation of serial interface baud rate
- F12 : Designation of serial interface output mode
- F13 : Set HOLD type
- F14 : Select of clock option

Select the primary base unit (CI-2001AS/BS kg/lb version)		
<b>F01</b>	0	Primary unit is kg
	1	Primary unit is lb

Serial port usage		
<b>F02</b>	0	Connection with computer and sub-display (CD-3000A)
	1	Connection with serial printer

Automatic zero tracking			
<b>F03</b>	0	None automatic zero	
	1	1 : 0.5 digit	Autozero tracking will automatically bring the display back to "0" when there are small deviations.
	~		
9	9 : 4.5 digit		

Digital filter			
<b>F04</b>	1	1 : Less vibration	Adjust the set value according to the condition.
	~		
	9	9 : Much vibration	

Select the weight back-up mode			
<b>F07</b>	0	Weight back-up is off (Power on zero)	
	1	Weight back-up is on (Display setting weight)	

"ENTER" key usage (CI-2001AS kg version)			
<b>F09</b>	0	Not used	
	1	Total print key	
	2	HOLD key	

"ENTER" key usage (CI-2001AS kg/lb version)			
<b>F09</b>	0	Not used	
	1	<ul style="list-style-type: none"> <li>- Print key (Press "PRINT" key)</li> <li>- Total Print key (by pressing "PRINT" key more than 3 second.)</li> </ul>	
	2	HOLD key	

"ENTER" key usage (CI-2001BS kg version)		
<b>F09</b>	0	Not used
	1	Total print key
	2	HOLD key
	3	LCD manual back-light key

"ENTER" key usage (CI-2001BS kg/lb version)		
<b>F09</b>	0	Not used
	1	- Print key (Press "PRINT" key) - Total Print key (by pressing "PRINT" key more than 3 second.)
	2	HOLD key
	3	LCD manual back-light key

Device ID			
<b>F10</b>	00	00 : Device ID "00"	It is used the no. of indicator when system is connected.
	~		
	99	99 : Device ID "99"	

Baud rate		
<b>F11</b>	0	600 bps
	1	1200 bps
	2	2400 bps
	3	4800 bps
	4	9600 bps
	5	19200 bps

Output mode			
<b>F12</b>	0	In case selecting No.1 of F02, this function must be set up.	No data output
	1		Stream mode
	2		Transmit only in stable condition
	3		Transmit when data is required → Request signal: device ID (F10 : Device ID) → In case F10 : 1, send hex value 01h in computer

Set HOLD type		
<b>F13</b>	0	Average hold: Compute the average weight of oscillating weights.
	1	Peak hold: Compute the maximum weight among oscillating weights.
	2	Sampling hold

Select option clock		
<b>F14</b>	0	Not use clock
	1	Use clock

Change date/time (Ex. 2000/1/11 13:10:01)		
▲: Increase of no. ◀: Shift of digit  ENTER: Store and move into next menu	LED Display	Meaning
	C1 98	Year :00
	C2 12	Month :01
	C3 11	Day :11
	C4 13	Hour :13
	C5 10	Minute :10
	C6 01	Second :01

# SERIAL INTERFACE

## OP-1 RS-232C Serial Interface(COM1)

### ■ Transmit mode: RS-232C interface

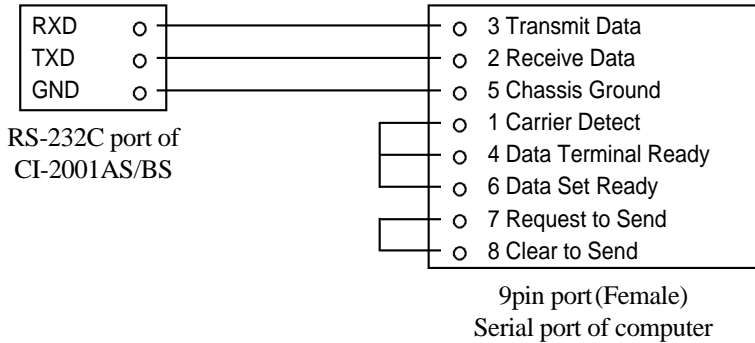
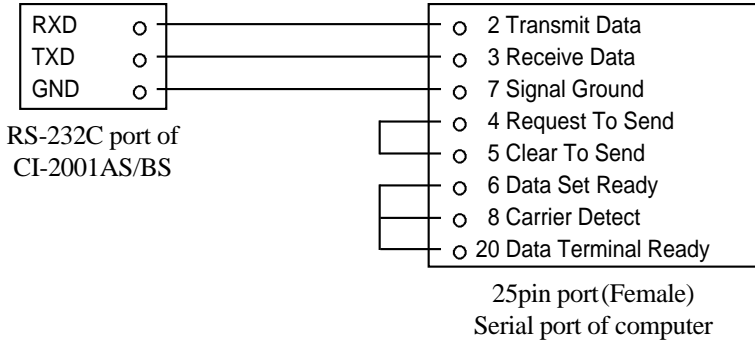

### ■ Sub-display Connection

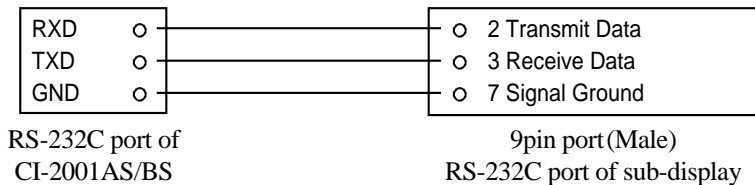

■ Transmit Data Format (22 bytes)

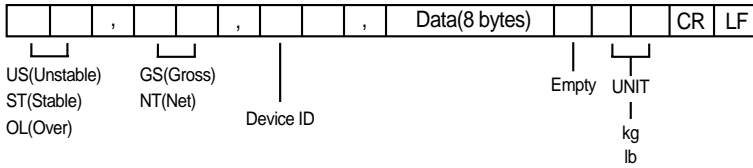

▶ Device ID

Transmit 1 byte device ID so that the receiver can receive data selectively which indicator send.

(Device ID is able to set at F10.)

▶ Data(8 bytes) : Weight data with decimal point

1. 13.5 kg : '0', '0', '0', '0', '1', '3', '.', '5'

2. 135 kg : '0', '0', '0', '0', '1', '3', '5', '0'

3. -135 kg : '-', '0', '0', '0', '1', '3', '5', '0'

Each ASCII code of weight transmitted by 8 byte.('0' : 0 × 20)

■ Simple Interface Program (Language : BASIC)

```

10 OPEN "COM1:9600,N,8,1" As #1
20 IF LOC(1) = 0 THEN 60
30 A$ = INPUT$(1,1)
40 PRINT A$ ; " ";
50 GOTO 20
60 B$=INKEY$ : IF B$ ="" THEN 20
70 PRINT B$ ; " ";
80 PRINT #1,B$;
90 GOTO 20
    
```

■ Simple Interface Program(Language C)

```

#include <bios.h>
#include <conio.h>

#define COM1      0
#define DATA_READY 0x100
#define TRUE      1
#define FALSE     0

#define SETTINGS  0xE3

int main(void)
{
    int in, out, status, DONE = FALSE;

    bioscom(0, SETTINGS, COM1);
    cprintf("... BIOSCOM [ESC] to exit ... \n");
    while (!DONE)
    {
        status = bioscom(3, 0, COM1);
        if (status & DATA_READY)
            if ((out = bioscom(2, 0, COM1) & 0x7F) != 0)
                putchar(out);
        if (kbhit())
        {
            if ((in = getch()) == '\x1B')
                DONE = TRUE;
            bioscom(1, in, COM1);
        }
    }
    return 0;
}

```

■ ND Series serial printer connection

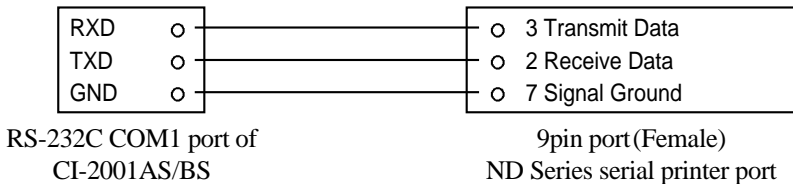



<b>Option</b>	<b>RS-422/485 Serial Interface(COM1)</b>
---------------	--

- Transmit mode: Same as RS-232C interface COM1
- Data format: Same as RS-232C interface COM1
- Connecting method of RS-485 port

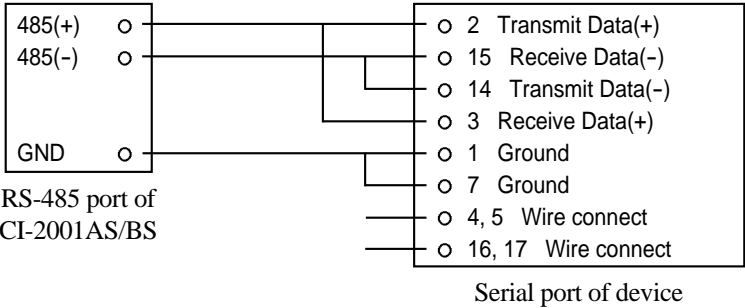

- Connecting method of RS-485 remote sub display

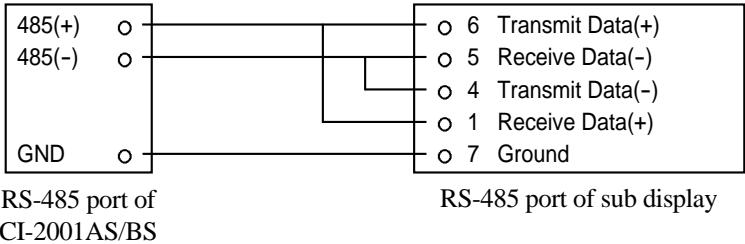



# ERROR MESSAGE & TROUBLE SHOOTING

## 1. Errors in Weighing Mode

### Err 02

- Reason: Load cell connection failure or error in A/D conversion part.
- Trouble shooting: Check the load cell connector to see if the polarity of signal is reversed.

### Err 06

- Reason: Error in printer connection
- Trouble shooting: Check with printer connector.  
If there is no problem with printer and printer connector, please request A/S to head office.

### Err 08

- Reason: The ZERO key or TARE key is adjusted not to be operated under the unstable condition.
- Trouble shooting: Press zero or tare key in stable condition.

### Err 10

- Reason: Tare weight exceeds the maximum capacity of the scale.
- Trouble shooting: Set the tare to be smaller than the maximum capacity.  
Otherwise the maximum capacity is reset to be larger than the tare to be set in the calibration menu, and reset the calibration using weight.

### Err 13

- Reason: The zero range deviates from the set range.
- Trouble shooting: Confirm that there is nothing on the weighing platform.  
If nothing exist, do calibration in CAL mode.

### Over

- Reason: The weight on platform is too heavy to be measured.
- Trouble shooting: Do not load the item exceeds the maximum tolerance.  
If the load cell is damaged, the load cell should be replace.

## 2. Errors in Calibration Mode

### Err 21

- Reason: The resolution is set to be exceeded the limit 1/50,000.
- Trouble shooting: Lower the resolution.  
The resolution = allowed weight/one division  
Modify the allowed weight in CAL 1 or modify the division in CAL 2 so that the resolution should be below 1/50,000.

### Err 22

- Reason: The weight for span calibration is set to be lower than 1% of the maximum capacity of the scale.
- Trouble shooting: Set the weight for span calibration in CAL 3 to be more than 10% of the maximum capacity.

### Err 23

- Reason: The weight for span calibration is set to be exceeded 100% of the maximum capacity of the scale.
- Trouble shooting: Set the weight for span calibration to be within the maximum capacity of the scale in CAL 1.

### Err 24

- Reason: The load cell output is too small at SPAN calibration.
- Trouble shooting: Setting of current resolution is not possible due to the error in load cell. Proceed calibration again with less resolution.

Load cell sense voltage for 5V excitation voltage	Recommended resolution
2mV	1/1,000
4mV	1/2,000
10mV	1/5,000

### Err 25

- Reason: The load cell output is too large at SPAN calibration.
- Trouble shooting: Setting of current resolution is not possible due to the error in load cell. Proceed calibration again with less resolution.

### **Err 26**

- Reason: The load cell output is too large at ZERO calibration.
- Trouble shooting: Check whether the platform empty.  
Proceed calibration again after checking in A/D TEST mode.

► **Notice: Specifications are subject to change for improvement without notice.**

9007-C2S-0033-0

2000. 7