

# HR-AZ / HR-A SERIES

HR-250AZ / HR-150AZ / HR-100AZ  
HR-250A / HR-150A / HR-100A

Analytical Balance

INSTRUCTION MANUAL



1WMPD4002375

© 2012 A&D Company Ltd. All rights reserved.

No part of this publication may be reproduced, transmitted, transcribed, or translated into any language in any form by any means without the written permission of A&D Company Ltd.

The contents of this manual and the specifications of the instrument covered by this manual are subject to change for improvement without notice.

Windows, Word and Excel are the registered trademarks of the Microsoft Corporation.

# CONTENTS

## Basic Operation

<b>1. INTRODUCTION</b> .....	<b>3</b>
1-1 About This Manual .....	3
1-2 Features .....	3
1-3 Compliance .....	4
<b>2. UNPACKING THE BALANCE</b> .....	<b>5</b>
2-1 Unpacking .....	5
2-2 Installing the Balance .....	6
<b>3. PRECAUTIONS</b> .....	<b>7</b>
3-1 Before Use .....	7
3-2 During Use .....	7
3-3 After Use .....	8
3-4 Power Supply .....	8
<b>4. DISPLAY SYMBOLS AND KEY OPERATION</b> .....	<b>9</b>
<b>5. WEIGHING UNITS</b> .....	<b>10</b>
5-1 Units .....	10
5-2 Storing Units .....	12
<b>6. WEIGHING</b> .....	<b>13</b>
6-1 Basic Operation (Gram Mode) .....	13
6-2 Counting Mode (PCS) .....	14
6-3 Percent Mode (%) .....	16
6-4 Statistical Calculation Mode .....	17
6-5 Statistical Calculation Mode (Example of Use) .....	21

## Adapting to the Environment

<b>7. RESPONSE ADJUSTMENT</b> .....	<b>23</b>
<b>8. CALIBRATION</b> .....	<b>24</b>
8-1 Calibration Mode .....	24
8-2 Calibration Using the Internal mass (One-Touch Calibration, only for HR-AZ series) .....	25
8-3 Calibration Test Using the Internal Mass .....	26
8-4 Correcting the Internal Mass Value: 1 (Only for HR-AZ series) .....	27
8-5 Correcting the Internal Mass Value: 2 (Only for HR-AZ series) .....	28
8-6 Calibration Using an External Weight .....	29
8-7 Calibration Test Using an External Weight .....	31
<b>9. FUNCTION SWITCH AND INITIALIZATION</b> .....	<b>33</b>
9-1 Permit or Inhibit .....	33
9-2 Initializing the Balance .....	34

## **Functions**

<b>10. FUNCTION TABLE .....</b>	<b>35</b>
10-1 Structure and Sequence of the Function Table .....	35
10-2 Display and Keys .....	35
10-3 Details of the Function Table .....	36
10-4 Description of the Class “Environment, Display” .....	39
10-5 Description of the Item “Data Output Mode” .....	41
10-6 Description of the Item “Data Format” .....	42
10-7 Data Format Examples .....	44
10-8 Description of the Item “Application Function” .....	45
10-9 Clock and Calendar Function (Only for HR-AZ series).....	46
10-10 Comparator Function .....	48
<b>11. ID NUMBER AND GLP REPORT .....</b>	<b>49</b>
11-1 Setting the ID Number .....	49
11-2 GLP Report .....	50
<b>12. UNDERHOOK .....</b>	<b>53</b>
<b>13. DENSITY MEASUREMENT (SPECIFIC GRAVITY) .....</b>	<b>54</b>
<b>14. PROGRAMMABLE-UNIT .....</b>	<b>59</b>

## **RS-232C Serial Interface**

<b>15. RS-232C SERIAL INTERFACE .....</b>	<b>60</b>
<b>16. CONNECTION TO PERIPHERAL EQUIPMENT .....</b>	<b>61</b>
16-1 Connection to the AD-8121B Printer .....	61
16-2 Connection to a Computer.....	62
16-3 Using Windows Communication Tools (WinCT).....	62

## **Maintenance**

<b>17. COMMANDS .....</b>	<b>64</b>
17-1 Command List.....	64
17-2 Acknowledge Code and Error Codes .....	65
17-3 Settings Related to RS-232C .....	67
<b>18. MAINTENANCE .....</b>	<b>68</b>
<b>19. TROUBLESHOOTING .....</b>	<b>68</b>
19-1 Checking the Balance Performance and Environment.....	68
19-2 Error Codes .....	69
19-3 Asking For Repair .....	70
<b>20. OPTIONS .....</b>	<b>71</b>
<b>21. SPECIFICATIONS.....</b>	<b>73</b>
<b>22. EXTERNAL DIMENSIONS .....</b>	<b>74</b>
<b>23. TERMS/INDEX.....</b>	<b>75</b>

# 1. INTRODUCTION

This manual describes how the HR-AZ / HR-A series balance works and how to get the most out of it in terms of performance.

Read this manual thoroughly before using the balance and keep it at hand for future reference.

## 1-1 About This Manual

---

This manual consists of the following five parts:

- Basic operation ..... Describes precautions on handling the balance, balance construction and basic balance operation.
- Adapting to the environment .... Describes response adjustment and calibration.
- Functions ..... Describes various functions of the balance.
- RS-232C serial interface ..... Describes the interface which transmits data and controls the balance.
- Maintenance ..... Describes maintenance, error codes, troubleshooting, specifications and options.

## 1-2 Features

---

- The HR-AZ series balance is equipped with an internal mass for one-touch calibration.
- Casing construction, strong protection against dust and moisture.
- Multiple weighing units with most of the common units used around the world.
- Standard RS-232C serial interface to communicate with a computer and to output the Good Laboratory Practice (GLP) data
- Statistical calculation mode to statistically calculate the weight data, and display or output the sum, maximum, minimum, range (maximum-minimum), average, standard deviation and coefficient of variation.
- Comparator Indicators, displaying the comparison results.
- Hold Function, provided for weighing a moving object such as an animal.
- Breeze break, provided for better stability if drafts are present.
- Underhook, provided for suspended weighing.
- As options, the USB interface (HRA-02), the Ethernet interface (HRA-08) and the built-in battery unit (HRA-09) are available.  
Connecting the USB interface, by cable to a Windows computer, allows transmission of the weight data to Excel or Word. The Ethernet interface allows connection of the balance to a personal computer through a LAN. The battery unit allows use of the balance where a power source is not available.
- The AD-8920A remote display, that is sold separately, allows reading the weight value in a place away from the balance.
- The optional AD-1688 data logger provides easy weighing data management.
- The optional AD-1687 weighing environment logger provides easy management of the weighing data, such as environmental data for the weighing and so on.

# 1-3 Compliance

---

## Compliance with FCC Rules

Please note that this device generates, uses and can radiate radio frequency energy. This device has been tested and has been found to comply with the limits of a Class A computing device pursuant to Subpart J of Part 15 of FCC rules. These rules are designed to provide reasonable protection against interference when this device is operated in a commercial environment. If this unit is operated in a residential area, it may cause some interference and under these circumstances the user would be required to take, at his own expense, whatever measures are necessary to eliminate the interference.

(FCC = Federal Communications Commission in the U.S.A.)

## Compliance With EMC Directives

**CE** This device features radio interference suppression and safety regulation in compliance with the following Council Directives

Council directive 2004/108/EC    EN61326    EMC directive

Council directive 2006/95/EC    EN60950    Safety of Information Technology Equipment

- The CE mark is an official mandatory European marking.

Please note that any electronic product must comply with local laws and regulations when sold or used anywhere outside Europe.

## 2. UNPACKING THE BALANCE

### 2-1 Unpacking

- The balance is a precision instrument. Unpack the balance carefully. Keep the packing material to be used for transporting the balance in the future.
- See the illustrations to confirm that everything is contained.

#### Install the large breeze break when drafts are present

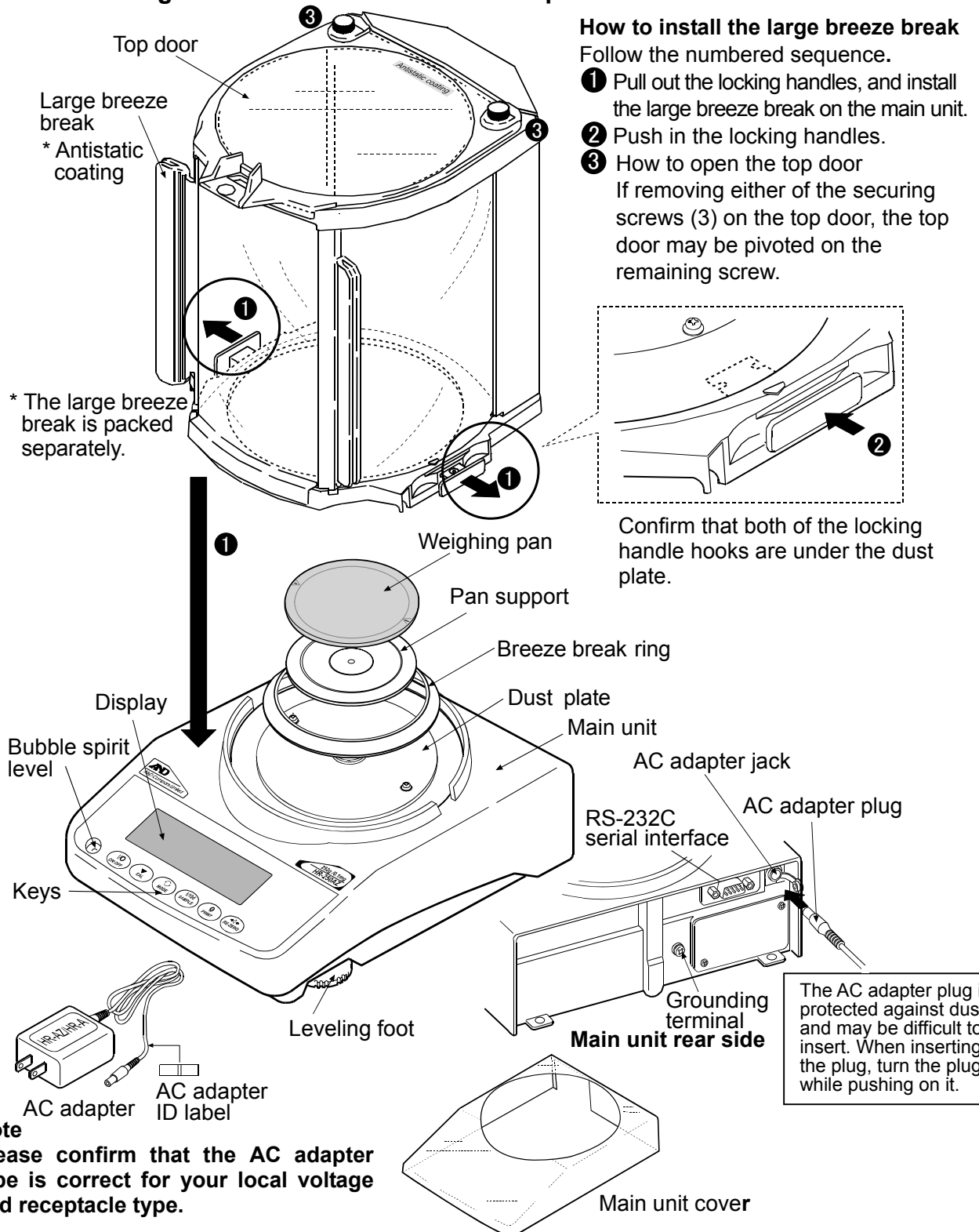

## 2-2 Installing the Balance

---

Install the balance as follows:

1. Place the balance on a solid weighing table. Refer to “3. PRECAUTIONS” for installing the balance.
2. Assemble the pan support, weighing pan, breeze break ring and breeze break, on the balance as shown in the illustration on page 5.
3. Adjust the leveling feet to level the balance. Confirm it using the bubble spirit level.
4. Confirm that the AC adapter type is correct for the local voltage and power receptacle type.
5. Connect the AC adapter to the balance. Warm up the balance for at least one hour with nothing on the weighing pan.

### **Note**

**The AC adapter plug is protected against dust and may be difficult to insert. When inserting the plug, turn the plug while pushing on it.**



## 3. PRECAUTIONS

To get the optimum performance from the balance and acquire accurate weight data, note the following:

### 3-1 Before Use

- Install the balance in an environment where the temperature and humidity are not excessive. The best operating temperature is about 20°C / 68°F at about 50% relative humidity.
- Install the balance where it is not exposed to direct sunlight and it is not affected by heaters or air conditioners.
- Install the balance where it is free of dust.
- Install the balance away from equipment which produces magnetic fields.
- Install the balance in a stable place avoiding vibration and shock. Corners of rooms on the first floor are best, as they are less prone to vibration.
- The weighing table should be solid and free from vibration, drafts and as level as possible.
- Level the balance by adjusting the leveling feet and confirm it using the bubble spirit level.
- Ensure a stable power source when using the AC adapter.
- Plug in the AC adapter and warm up the balance for at least one hour.
- Calibrate the balance before use or after having moved it to another location.

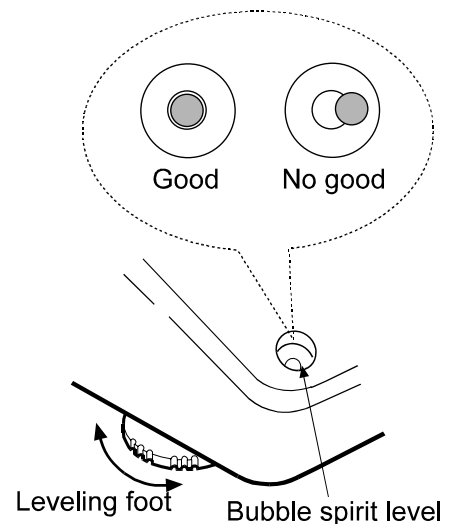

### Caution

Do not install the balance where flammable or corrosive gas is present.

### 3-2 During Use

- Discharge static electricity from the material to be weighed (hereinafter referred to as the sample). When a sample could have a static charge, the weight data is influenced. Ground the balance and try the following:
  - Eliminate static electricity using the optional AD-1683 DC static eliminator.
  - Try to keep the ambient humidity above 45%RH.
  - Use a metal shield case for a charged sample.
  - Wipe charged plastic samples with a moistened cloth.

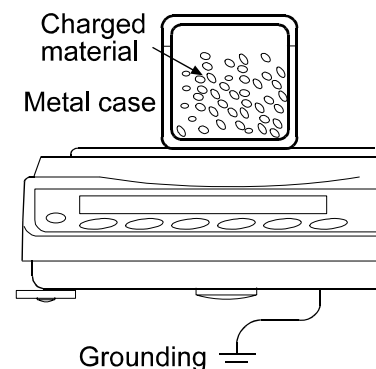

- This balance uses a strong magnet as part of the balance assembly, so please use caution when weighing magnetic materials such as iron. If there is a problem, use the underhook on the bottom of the balance to suspend the material away from the influence of the magnet.

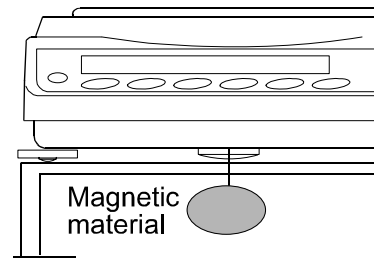

- Eliminate the temperature difference between a sample and the environment. When a sample is warmer (cooler) than the ambient temperature, the sample will be lighter (heavier) than the true weight. This error is due to a rising (falling) draft around the sample.
- Make each weighing gently and quickly to avoid errors caused by the evaporation of moisture from the sample or the absorption of moisture by the sample.
- Do not drop things upon the weighing pan, or place a sample on the pan that is beyond the balance weighing capacity. Place a sample in the center of the weighing pan.
- Do not use a sharp instrument such as a pencil to press the keys. Use your finger only.
- Press the **RE-ZERO** key before each weighing to eliminate possible errors.
- Calibrate the balance periodically so as to eliminate possible errors.
- Take into consideration the affect of air buoyancy on a sample when more accuracy is required.
- Keep the balance interior free of dust and foreign materials.
- The breeze break (The HR-AZ / HR-A series) is provided as a standard accessory. An anti-static treatment has been applied to the breeze break components, but they may be charged with static electricity when they are unpacked or when the humidity is low. If the weight value is unstable even when there are no drafts or the balance has a problem with repeatability, remove the breeze break. Or wipe the clear plates with a moistened cloth, use the optional AD-1683 DC static eliminator or apply an anti-static spray.

### 3-3 After Use

---

- Avoid mechanical shock to the balance.
- Do not disassemble the balance. Contact the local A&D dealer if the balance needs service or repair.
- Do not use organic solvents to clean the balance. Clean the balance with a lint free cloth that is moistened with warm water and a mild detergent.
- The edge of the weighing pan is sharp. Use much care when cleaning the pan.
- Avoid dust and water so that the balance weighs correctly. Protect the internal parts from liquid spills and excessive dust.
- The breeze break parts have an antistatic coating. Washing these parts with water, etc., will diminish the antistatic coating function.

### 3-4 Power Supply

---

- When the AC adapter is connected, the balance is in the standby mode if the standby indicator is on (refer to “4. DISPLAY SYMBOLS AND KEY OPERATION”). This is a normal state and does not harm the balance. For accurate weighing, warm up the balance for at least one hour before use.

# 4. DISPLAY SYMBOLS AND KEY OPERATION

## Key operation

Key operation affects how the balance functions. The basic key operations are:

- “Press and release the key immediately” or “Press the key”  
= normal key operation during measurement
- “Press and hold the key”

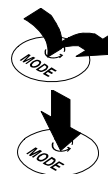

## Display symbols

- Number of statistical data (Statistical calculation mode)
- Displays the weight data relative to the weighing capacity, in percentage, in the weighing mode (Capacity indicator)
- Displays the setting value in the function mode

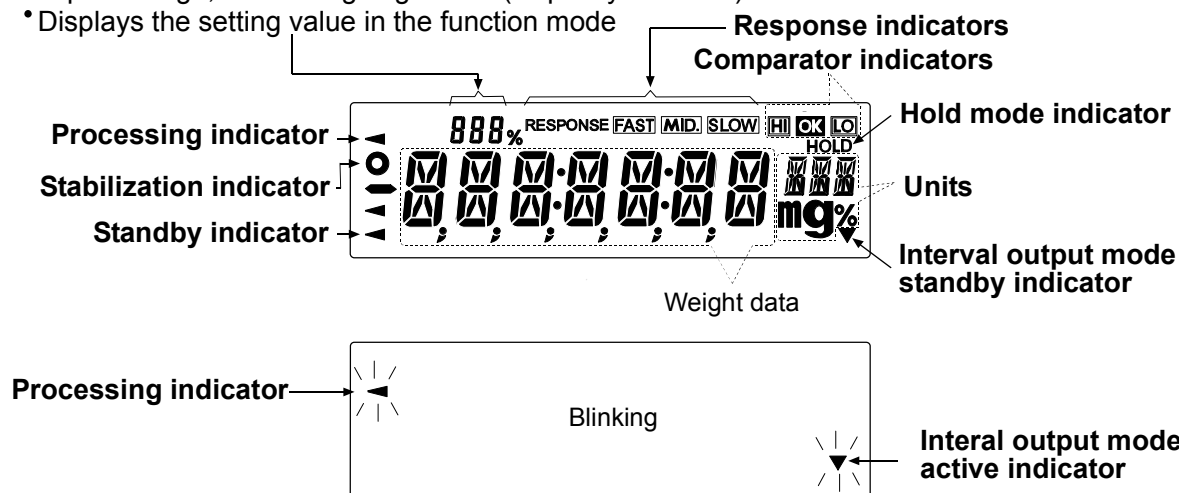

Each key, when pressed or when pressed and held, functions as follows:

Key	When pressed	When pressed and held
	Turns the display on or off. The standby indicator is displayed when the display is turned off. The weighing mode is enabled when the display is turned on. This key is available anytime. Pressing the key during operation will interrupt the operation and turn the display off.	
	In the weighing mode, turns the minimum weighing value on or off. In the counting or percent mode, enters the sample storing mode.	Enters the function table mode. Refer to “10. FUNCTION TABLE”.
	Switches the weighing units stored in the function table. Refer to “5. WEIGHING UNITS”.	Enters the response adjustment mode.
	Cancels the operation when performing settings. With the HR-AZ series, enters the calibration mode using the internal mass. (One-touch calibration)	Enters the calibration mode.
	Outputs the weight data to a printer or personal computer using the RS-232C serial interface, depending on the function table settings. Confirms the operation when performing settings.	No function at the factory setting By changing the function table: Outputs “Title block” and “End block” for GLP report.
	Sets the display to zero.	

# 5. WEIGHING UNITS

## 5-1 Units

With the HR-AZ / HR-A series balance, the following weighing units and weighing modes are available:

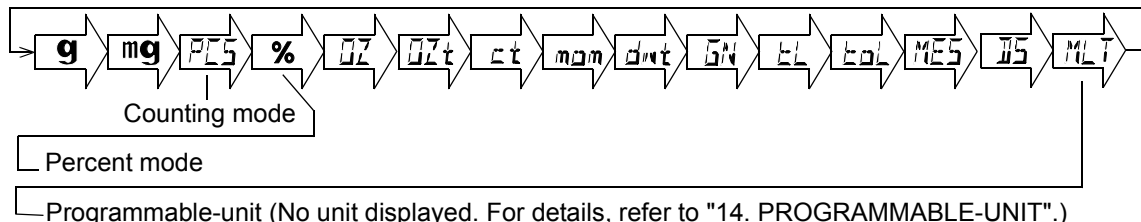

A unit or mode can be selected and stored in the function table as described on page 12.

If a weighing mode (or unit of weight) has been turned off, that mode or unit will be missing in the sequence. Tael has four varieties, one of which can be selected and installed at the factory.

To select a unit or mode for weighing, press the **MODE** key.

For details about the units and modes, see the table below:

Name (unit, mode)	Display	Function table (Storing mode)	Conversion factor 1 g =
Gram	g	g	1 g
Milligram	mg	mg	0.001g
Counting mode	PCS	PCS	—
Percent mode	%	%	—
Ounce (Avoir)	OZ	OZ	28.349523125 g
Troy Ounce	OZt	OZt	31.1034768 g
Metric Carat	ct	ct	0.2 g
Momme	mom	mom	3.75 g
Pennyweight	dwt	dwt	1.55517384 g
Grain (UK)	GN	GN	0.06479891 g
Tael (HK general, Singapore)	tL	tL	37.7994 g
Tael (HK jewelry)			37.429 g
Tael (Taiwan)			37.5 g
Tael (China)			31.25 g
Tola (India)	tOL	tOL	11.6638038 g
Messghal	MES	MES	4.6875 g
Density mode	JS	JS	—
Programmable-unit (Multi-unit)	MLT	MLT	—

The tables below indicate the weighing capacity and the minimum display for each unit, depending on the balance model.

Unit	Capacity			Minimum display
	HR-100AZ HR-100A	HR-150AZ HR-150A	HR-250AZ HR-250A	
Gram	102	152	252	0.0001
Ounce (Avoir)	3.59	5.36	8.88	0.00001
Troy Ounce	3.27	4.88	8.10	0.00001
Metric Carat	510	760	1260	0.001
Momme	27.2	40.5	67.2	0.0001
Pennyweight	65.5	97.7	162.0	0.0001
Grain (UK)	1574	2346	3889	0.002
Tael (HK general, Singapore)	2.69	4.02	6.66	0.00001
Tael (HK jewelry)	2.72	4.06	6.73	0.00001
Tael (Taiwan)	2.72	4.05	6.72	0.00001
Tael (China)	3.26	4.86	8.06	0.00001
Tola (India)	8.74	13.0	21.6	0.00001
Messghal	21.7	32.4	53.7	0.0001

## 5-2 Storing Units

The units or modes can be selected and stored in the function table. The sequence of displaying the units or modes can be arranged in the function table so as to fit the frequency of use.

Select a unit or mode and arrange the sequence of display as follows:

- 1 Press and hold the **SAMPLE** key until **bASFnC** of the function table is displayed.
- 2 Press the **SAMPLE** key several times to display **Unit**.
- 3 Press the **PRINT** key to enter the unit selection mode.
- 4 Specify a unit or mode in the order to be displayed using the following keys.

**SAMPLE** key To sequentially display the units.

**RE-ZERO** key To specify a unit or mode. The stabilization indicator appears when the displayed unit or mode is specified.

- 5 Press the **PRINT** key to store the units or modes. The balance displays **End** and then displays the next menu item of the function table.
- 6 Press the **CAL** key to exit the function table. Then the balance returns to the weighing mode with the unit specified first in step 4.

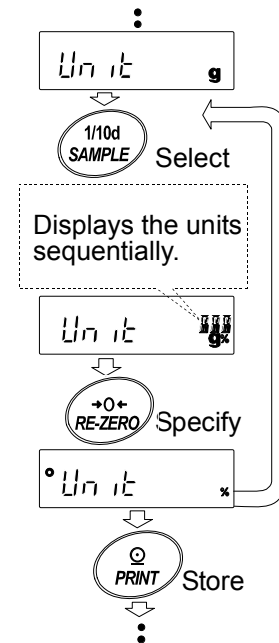

### Notes

**When the power is turned on, the scale displays the unit specified first in step 4.**

**In the weighing mode, to select a unit or mode for weighing, press the **MODE** key.**

# 6. WEIGHING

## 6-1 Basic Operation (Gram Mode)

- 1 Place a container on the weighing pan, if necessary.  
Press the **RE-ZERO** key to cancel the weight (tare). The balance displays **0.0000 g**. (The decimal point position depends on the balance model.)
- 2 Place a sample on the pan or in the container.
- 3 Wait for the stabilization indicator to turn on. Read the value.

While the stabilization indicator is on, pressing the **PRINT** key will output the weight value, using the RS-232C serial interface.

### Note

Peripheral equipment, that is sold separately, such as a printer or a personal computer is required.

- 4 Remove the sample and container from the pan.

### Notes

To use other units, press the **MODE** key and select an appropriate unit.

Press the **SAMPLE** key to turn on or off the minimum weighing value.

When the **ON:OFF** key is pressed with a container placed on the weighing pan, the balance displays **0.0000 g** and weighing is started,

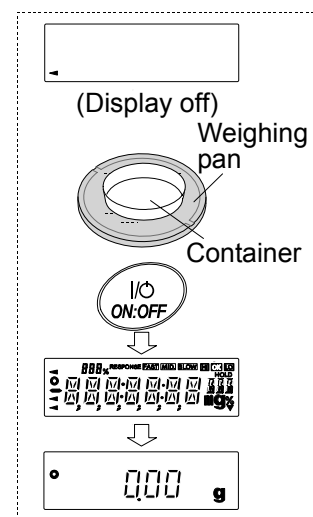
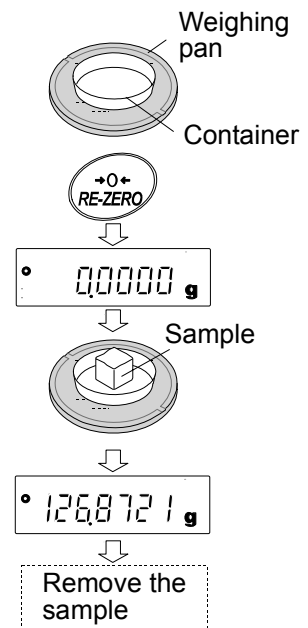

## 6-2 Counting Mode (PCS)

This is the mode to determine the number of objects in a sample based on the standard sample unit mass. The unit mass means the mass of one piece of the sample. The smaller the variables in each sample unit mass are, the more accurate the counting will be. The balance is equipped with the Automatic Counting Accuracy Improvement (ACAI) function to improve the counting accuracy.

### Notes

**For counting, use samples with a unit mass of at least ten or more times the minimum weighing value of the balance.**

**If the sample unit mass variable is too large, it may cause a counting error.**

**To improve the counting performance, use the ACAI function frequently or divide the samples into several groups and count each group.**

### Selecting the counting mode

- 1 Press the **MODE** key to select **PCS** (counting mode).

### Storing a sample unit mass

- 2 Press the **SAMPLE** key to enter the sample unit mass storing mode.

Even in the storing mode, pressing the **MODE** key will switch to the next mode.

- 3 To select the number of samples, press the **SAMPLE** key several times. It may be set to 10, 25, 50 or 100.

### Note

**A greater number of samples will yield more accurate counting result.**

- 4 Place a container on the weighing pan, if necessary. Press the **RE-ZERO** key to cancel the weight (tare). The number specified in step 3 appears.

e.g.: **25.0** is displayed if 25 is selected in step 3.

- 5 Place the number of samples specified on the pan. In this example, 25 pieces.

- 6 Wait for the stabilization indicator to turn on. Press the **PRINT** key to calculate and store the unit mass. The balance displays **25.000** (counting mode) and is set to count samples with this unit mass.

To improve the accuracy of the unit mass, go to step 8.

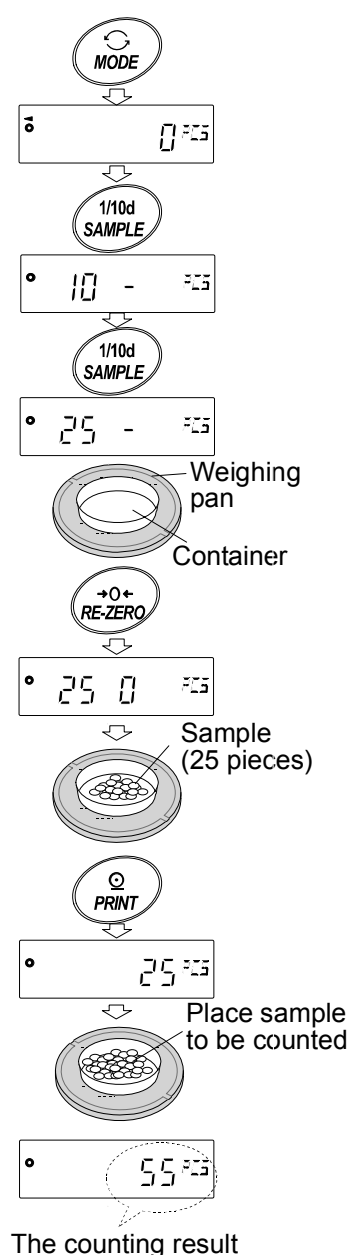



## Notes

If the balance judges that the mass of the samples is too light and is not adequate to be used as the unit mass, it displays **Lo**. In that case, store the mass by some quantity. For example, when the model with the minimum weighing value of 0.0001 g is used and 10 pieces of samples weigh 0.0005 g. Store 100 pieces of samples as 10 and multiply the weighing result by 10.

If the balance judges that the mass of the samples is too light to acquire accurate weighing, it displays an error requiring the addition of more samples to the specified number. For example, **50-PCS** appears to require 25 more samples. Add 25 samples and press the **PRINT** key. When the unit mass is stored correctly, the balance proceeds to the counting mode.

For a more accurate counting operation, use samples with a unit mass of at least ten or more times the minimum weighing value of the balance. For example, when a balance with a minimum weighing value of 0.0001 g is used, the recommended sample unit mass is 0.001 g or more.

The sample unit mass stored, even if the AC adapter is removed, is maintained in non-volatile memory.

## Counting operation

- Place the samples to be counted on the pan.  
While the stabilization indicator is on, pressing the **PRINT** key will output the weight value (number of objects), using the RS-232C serial interface.

### Note

Peripheral equipment, that is sold separately, such as a printer or a personal computer is required.

## Counting mode using the ACAI function

The ACAI is a function that improves the accuracy of the unit mass automatically by increasing the number of samples and averaging the unit mass variable to minimize the weighing error, as the counting process proceeds.

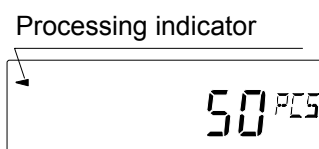

- If a few more samples are added, the processing indicator turns on. To prevent an error, add three or more. The processing indicator does not turn on if overloaded. Try to add the same number of samples as displayed.
- The balance re-calculates the unit mass while the processing indicator is blinking. Do not touch the balance or samples on the pan until the processing indicator turns off.
- Counting accuracy is improved when the processing indicator turns off.  
Each time the above operation is performed, a more accurate unit mass will be obtained. There is no definite upper limit of ACAI range for the number of samples exceeding 100. Try to add the same number of samples as displayed.
- Remove all the samples used in ACAI and proceed with the counting operation using the improved unit mass.

## 6-3 Percent Mode (%)

This is the mode to display the weight value in percentage compared to a 100% reference mass and is used for target weighing or checking the sample variable.

### Selecting the percent mode

- 1 Press the **MODE** key to select **%** (percent mode).

### Storing the 100% reference mass

- 2 Press the **SAMPLE** key to enter the 100% reference mass storing mode.

Even in the storing mode, pressing the **MODE** key will switch to the next mode.

- 3 Place a container on the weighing pan, if necessary. Press the **RE-ZERO** key to cancel the weight (tare). The balance displays **100 0 %**.
- 4 Place the sample to be set as the 100% reference mass on the pan or in the container.
- 5 Press the **PRINT** key to store the reference mass. The balance displays **100.00 %**. (The decimal point position depends on the reference value.)

### Notes

If the balance judges that the mass of the sample is too light to be used as a reference, it displays **Lo**. Do not use the sample.

The reference mass stored, even if the AC adapter is removed, is maintained in non-volatile memory

- 6 Remove the sample.

### Reading the percentage

- 7 Place a sample to be compared to the reference mass on the pan. The displayed percentage is based on the 100% reference mass.

While the stabilization indicator is on, pressing the **PRINT** key will output the weight value, using the RS-232C serial interface.

### Note

Peripheral equipment, that is sold separately, such as a printer or a personal computer is required.

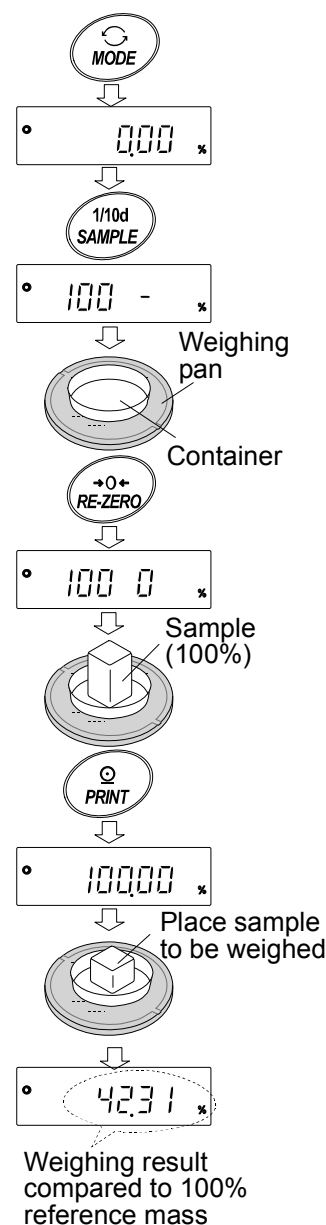

## 6-4 Statistical Calculation Mode

The statistical calculation mode statistically calculates the weight data, and displays or outputs the results. To use the statistical calculation mode, set the "Application function (APF)" parameter of "Application (AP Fnc)" in the function table to "2", as described below.

Statistical items available are number of data, sum, maximum, minimum, range (maximum-minimum), average, standard deviation, coefficient of variation and relative error. What statistical items to output can be selected from the four modes in the function table.

- The wrong data input can be canceled by the key operation, if immediately after the input.
- Turning the balance off will delete the statistical data.
- The standard deviation, coefficient of variation and relative error are obtained by the equation below:

$$\text{Standard deviation} = \sqrt{\frac{N \cdot \sum (X_i)^2 - (\sum X_i)^2}{N \cdot (N-1)}} \quad \text{where } X_i \text{ is the } i\text{-th weight data,} \\ N \text{ is number of data.}$$

$$\text{Coefficient of variation (CV)} = \frac{\text{Standard deviation}}{\text{Average}} \times 100 (\%)$$

$$\text{Relative error of maximum value} = \frac{\text{Maximum value} - \text{Average}}{\text{Average}} \times 100 (\%)$$

$$\text{Relative error of minimum value} = \frac{\text{Minimum value} - \text{Average}}{\text{Average}} \times 100 (\%)$$

### 6-4-1 Getting Started

#### Switching to the Statistical Function Mode (Changing The Function Table)

- 1 Press and hold the **SAMPLE** key until **bASFnC** of the function table is displayed, then release the key.
- 2 Press the **SAMPLE** key several times to display **AP Fnc**.
- 3 Press the **PRINT** key to display **APF 0**.
- 4 Press the **RE-ZERO** key several times to display **APF 2**.

To select statistical items to output, go to step 5.  
To store the statistical function mode setting, go to step 7.  
To disable the statistical calculation mode, press the **RE-ZERO** key to select **APF 0**.

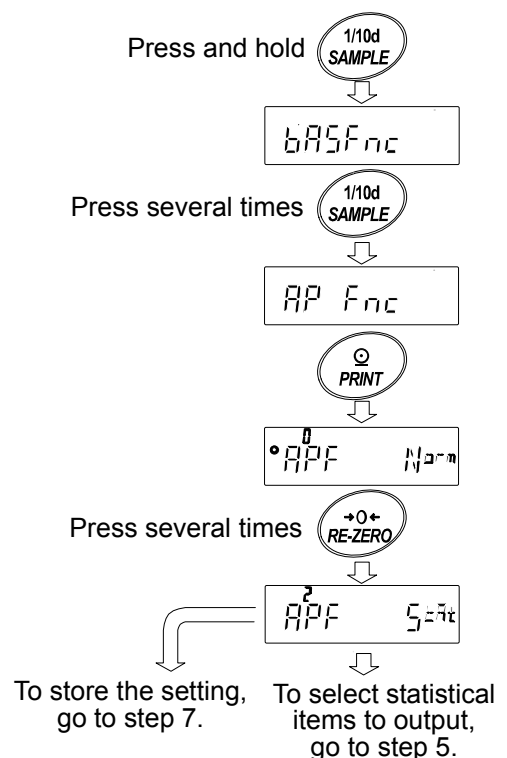

## Selecting the statistical items to output

5 Press the **SAMPLE** key to display **STAT 0**.

6 Press the **RE-ZERO** key to select the output items.  
In the example, **STAT 1** is selected to output the number of data, sum, maximum, minimum, range (maximum – minimum), and average (maximum-minimum) and average.

Parameter	Description
0	Number of data, sum
1	Number of data, sum Maximum, minimum, range (maximum – minimum), average
2	Number of data, sum Maximum, minimum, range (maximum – minimum), average, Standard deviation, coefficient of variation
3	Number of data, sum Maximum, minimum, range (maximum – minimum), average, Standard deviation, coefficient of variation Relative error of maximum value, relative error of minimum value

7 Press the **PRINT** key to store the setting.

### Note

The statistical calculation mode will be enabled using the **ON:OFF** key or when the power is turned on.

8 Press the **CAL** key to return to the weighing mode.

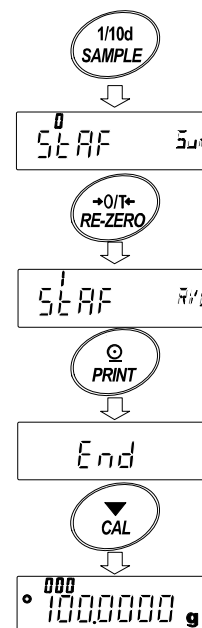

## Selecting the unit

9 Press the **MODE** key to select the unit to be used for the statistical calculation mode.

### Notes

Selecting the unit using the **MODE** key is not available after the data is entered. In this case, clear the data as described on page 20 and select the unit using the **MODE** key.

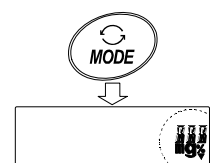

When the unit used for the statistical calculation mode is to be enabled upon power-on, select the unit in “Unit (Unit)” of the function table beforehand.

## 6-4-2 Using The Statistical Calculation Mode

### Entering data for statistical calculation

Use the following keys to operate the statistical calculation mode.

**MODE** key ..... ■ When the data is entered, moves between the displaying items (weighing mode, statistical results and data operation) each time the key is pressed.

■ When no data has been entered, selects the unit.

**SAMPLE** key ..... Turns the minimum weighing value on or off, in the weighing mode.

**RE-ZERO** key ..... Sets the display to zero in the weighing mode.

**PRINT** key ..... ■ Outputs the data number and the weight data and includes the weight data to statistical calculation in the weighing mode. (Output is not in the data format specified in the function table because of the data number added.)

■ Outputs the statistical results while the statistical results are displayed. (Output is not in the data format specified in the function table.)

**CAL** key ..... Returns to the weighing mode.

- 1 Press the **RE-ZERO** key to set the display to zero.
- 2 Place the sample on the weighing pan and wait for the stabilization indicator to turn on.
- 3 Press the **PRINT** key to add the data displayed to statistical calculation. The number of data on the upper left of the display increases by 1.
- 4 Repeat steps 1 to 3 for each weighing.

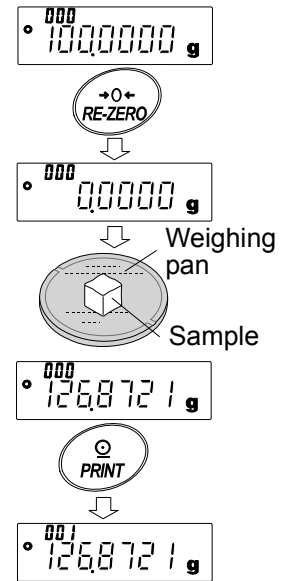

### Outputting the statistical results

- 5 Each time the **MODE** key is pressed, the display changes: the results as selected in “Statistical function mode output items (SLAF)”, **CLEAR** and **CANCEL**.

#### Notes

When the number of data is 1, the coefficient of variation is displayed as **-----**.

When the average is 0, the coefficient of variation is displayed as **-----**.

Statistical items are indicated on the upper left of the display using the following symbols.

Symbol	Statistical item
$\sum n$	Sum
$\bar{n}All$	Maximum
$\bar{n}in$	Minimum
$r$	Range (Maximum – minimum)
$\bar{A}VE$	Average
$SD$	Standard deviation
$\bar{C}V$	Coefficient of variation
$\bar{n}All\%$	Relative error of maximum value
$\bar{n}in\%$	Relative error of minimum value

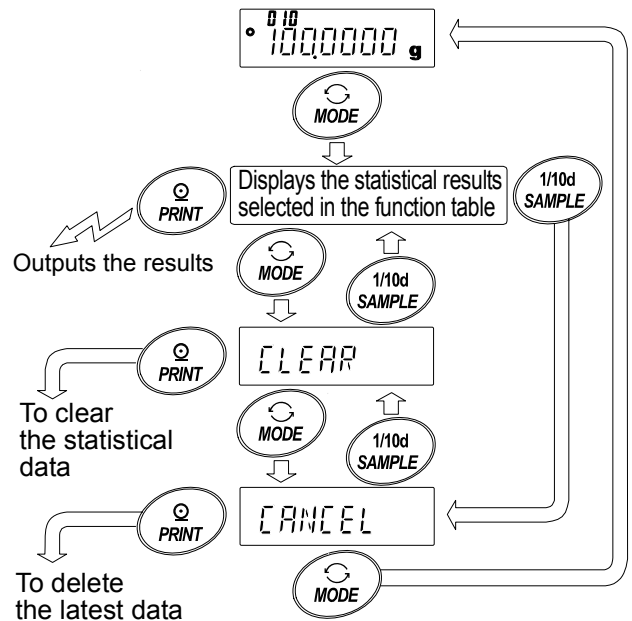

- 6 While the results are displayed, press the **PRINT** key to output the results.

#### Output example

		Function table parameter		
N	10	0	1	2
SUM	100.0000g			
MAX	10.5000g			
MIN	9.5000g	3		
R	1.0000g			
AVE	10.0000g			
SD	0.280 g			
CV	2.80 %			
MAX%	5.00 %			
MIN%	5.00 %			

## Deleting the latest data

When the wrong data is entered, it can be deleted and excluded from statistical calculation. Only the latest data can be deleted.

- 1 In the weighing mode, press the **MODE** key several times to display **CANCEL**.
- 2 Press the **PRINT** key to display **CAN no**.
- 3 Press the **RE-ZERO** key to display **CAN Co**.
- 4 Press the **PRINT** key to delete the latest data and exclude it from statistical calculation.  
The number of data decreases by 1 when the balance returns to the weighing mode.

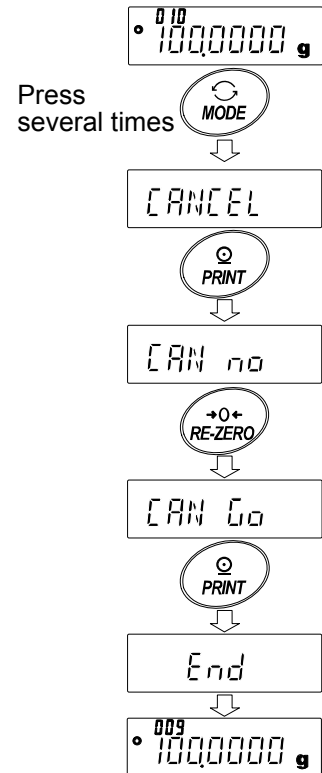

## Clearing the statistical data

All the statistical data will be deleted and the number of data will be 0 (zero).

- 1 In the weighing mode, press the **MODE** key several times to display **CLEAR**.
- 2 Press the **PRINT** key to display **Clr no**.
- 3 Press the **RE-ZERO** key to display **Clr Co**.
- 4 Press the **PRINT** key to delete the statistical data.  
The number of data becomes 0 (zero) when the balance returns to the weighing mode.

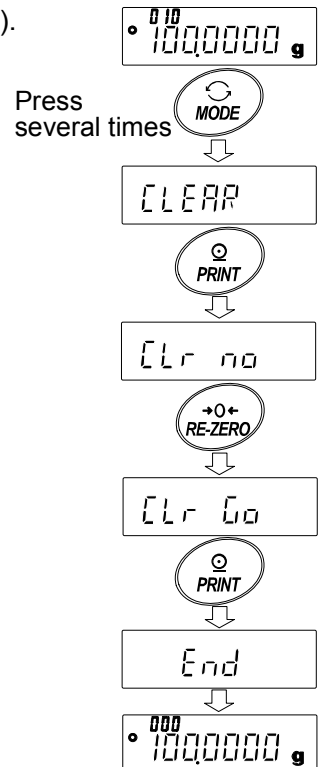

## 6-5 Statistical Calculation Mode (Example of Use)

Here, as an example of use of the statistical calculation mode, mixing of the multiple formulae such as medicine is described. The mixing process is recorded using the balance and the printer.

In the example, the HR-250AZ and the AD-8121B (dump print mode) are connected using the RS-232C serial interface.

### 6-5-1 Getting Started

#### Changing the function table

- Changes:
- To enable the statistical calculation mode
  - To enable “Zero after output”

#### Enabling the statistical calculation mode

- 1 Enter the function table menu.

Press and hold the **SAMPLE** key until **bASFnC** of the function table is displayed, then release the key.

- 2 Select the application function.

Press the **SAMPLE** key several times to display **AP Fnc**. Then, press the **PRINT** key to display **APF 0**.

- 3 Change the application function parameter to “2”.

Press the **RE-ZERO** key to display **APF 2**. Press the **PRINT** key to confirm the change. After **End**, **bASFnC** is displayed.

#### Enabling “Zero after output”

- 4 Select “Zero after output”.

Press the **SAMPLE** key several times to display **dout**. Then, press the **PRINT** key to display **°Prt 0**, and press the **SAMPLE** key several times to display **°Ar-d 0**.

- 5 Enable “Zero after output”.

Press the **RE-ZERO** key to display **Ar-d 1**. Then, press the **PRINT** key to confirm the change. After **End**, **SIF** is displayed.

#### Returning to the weighing mode

- 6 Press the **CAL** key to return to the weighing mode.

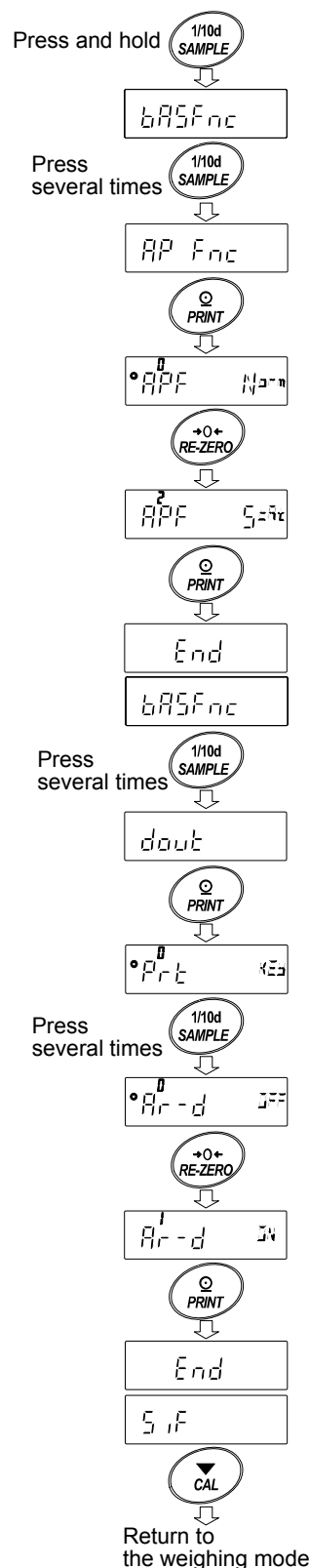

## 6-5-2 Using The Statistical Calculation Mode

- 1 Press the **RE-ZERO** key to set the display to zero.
- 2 Place a container on the weighing pan.  
Press the **PRINT** key to cancel the weight (tare). The balance displays **0.0000 g**. (Storing the tare value)  
The tare value data is output when the peripheral output equipment is connected.
- 3 Weigh formula 1 and press the **PRINT** key. The balance displays **0.0000 g**. (Storing the weight value of formula 1)  
The weight value data is output when the peripheral output equipment is connected.
- 4 Weigh formula 2 and press the **PRINT** key. The balance displays **0.0000 g**. (Storing the weight value of formula 2)  
The weight value data is output when the peripheral output equipment is connected.
- 5 When there are some more formulae to be added, repeat step 4.
- 6 After mixing is complete, press the **MODE** key to display the statistical results.
- 7 Press the **PRINT** key to output the number of data saved including the tare value and the total weight.

### Output example

No. 1		
ST. +005.6372 g	-----	Tare value
No. 2		
ST. +001.9921 g	-----	Formula 1
No. 3		
ST. +007.7804 g	-----	Formula 2
N	3	
SUM	+15.4097 g	-----
		Total weight

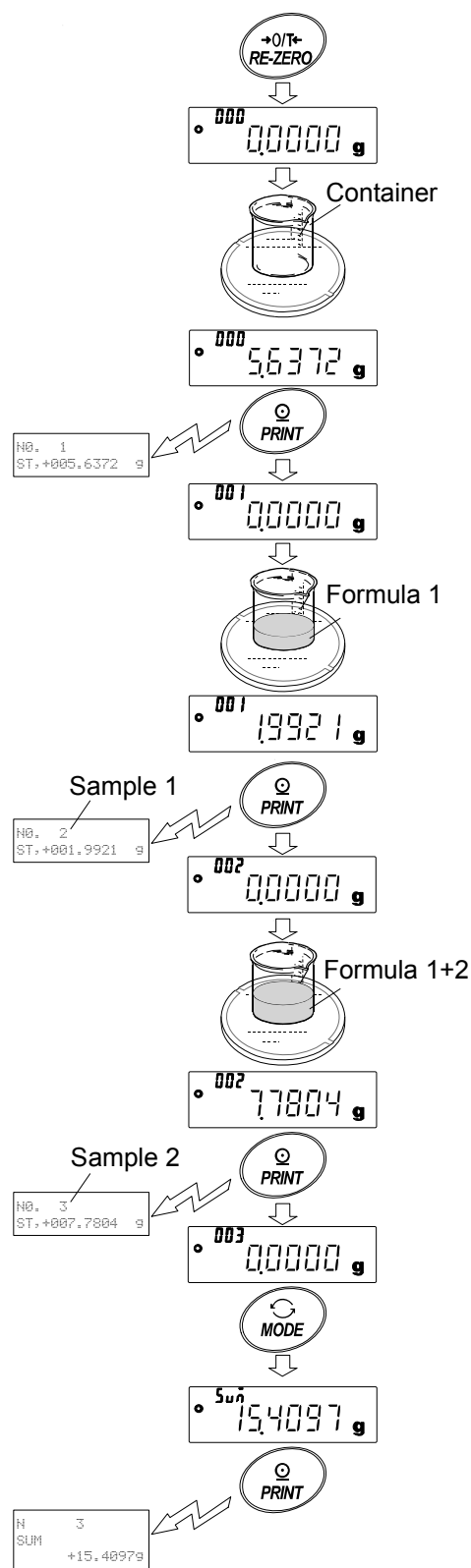



## 7. RESPONSE ADJUSTMENT

This function stabilizes the weight value, reducing the influence on weighing that is caused by drafts and vibration at the place where the balance is installed.

The function has three stages as follows and can be changed by simple key operation.

Indicator	Description
FAST	Fast response, but prone to drafts and vibration. Good for target weighing.
MID.	↕
SLOW	Slow response, but strong against drafts and vibration Good for weighing which requires a stable display.



### Operation

- 1 Press and hold the **MODE** key until **RESPONSE** is displayed. And then, release the key.
- 2 Press the **MODE** key to select a rate of the response adjustment. Either **FAST**, **MID.** or **SLOW** can be selected.
- 3 After a few seconds of inactivity, or when the **PRINT** key is pressed, the balance displays **End**. Then, it returns to the weighing mode and displays the updated response indicator. The response indicator remains displayed for a while.

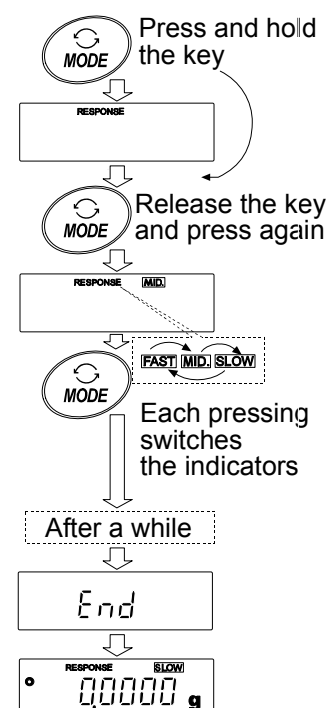

### Note

Setting the response rate automatically changes the “Condition (*Cond*)” and “Display refresh rate (*SPd*)” parameters of “Environment, Display (*bASFnC*)” in the function table, as shown below:

Indicator	<i>Cond</i> (Condition)	<i>SPd</i> (Display refresh rate)
FAST	0	1
MID.	1	0
SLOW	2	0

When the balance is to be used with other setting combinations, set each parameter in the function table.

# 8. CALIBRATION

## 8-1 Calibration Mode

The balance has the following modes.

- Calibration using the internal mass (One-touch calibration, only for the HR-AZ series)
- Calibration using an external weight
- Calibration test using an external weight (Calibration test does not perform calibration.)

### Terms

The following terms are defined as follows:

External weight = A weight that you have. Referred to as a calibration weight when used for calibration.

Calibration weight = A weight used for calibration

Target weight = An external weight used for calibration test

### Caution

- When calibrating, be sure to install the provided large breeze break.
- Calibration adjusts the balance for accurate weighing.  
Besides periodic calibration and before each use, perform calibration when:
  - The balance is installed for the first time.
  - The balance has been moved.
  - The ambient environment has changed.
- Do not allow vibration or drafts to affect the balance during calibration.
- To output the data for GLP using the RS-232C serial interface, set “GLP output ( *INF0* )” of “Data output ( *DOUt* )”. For details, refer to “10. FUNCTION TABLE”. To display the GLP output, a printer or personal computer is required.
- Calibration test is available only when “GLP output ( *INF0* )” of “Data output ( *DOUt* )” is set to “1” or “2”.

### Caution on using an external weight

- The accuracy of an external weight will influence the accuracy of weighing. Select an appropriate weight as listed below:

Model	Usable calibration weight	Adjustable range
HR-250A	250 g, <b>200 g</b> , 100 g, 50 g	-0.0150 g to +0.0150 g
HR-150A	150 g, <b>100 g</b> , 50 g	
HR-100A	<b>100 g</b> , 50 g	

The calibration weight in bold type: factory setting

The calibration weight value can be adjusted within the range above.

### Display



- This indicator means “the balance is measuring calibration data”. Do not allow vibration or drafts to affect the balance while this indicator is displayed.

## 8-2 Calibration Using the Internal mass (One-Touch Calibration, only for HR-AZ series)

---

This function calibrates the balance using the internal mass. The only operation required is to press the **CAL** key.

### Note

**Level the balance by adjusting the leveling feet and confirm that the bubble is in the center of the spirit level.**

**Poor level adjustment may cause a calibration error while using the internal mass.**

### Operation

- 1 Connect the AC adapter and warm up the balance for at least one hour with nothing on the weighing pan.
- 2 Place the provided large breeze break on the balance and press the **CAL** key.
- 3 The balance displays **CR In** and performs calibration using the internal mass. Do not allow vibration or drafts to affect the balance.
- 4 The balance displays **End** after calibration. If the “GLP output (Inf0)” parameter of the function table is set to “1” or “2”, the balance displays **GLP** and outputs “Calibration Report” using the RS-232C interface or stores the data in memory. For details on the calibration report format, refer to “11-2 GLP Report”.
- 5 The balance will automatically return to the weighing mode after calibration.

### About the internal mass

The mass of the internal mass may change due to corrosion or other damage caused by the operating environment, or due to aging. Check the internal mass periodically. Correct the internal mass value as necessary. For details, refer to “8-4 Correcting the internal mass value: 1” and “8-5 Correcting the internal mass value: 2”.

To maintain the weighing accuracy, perform the internal mass value correction periodically.

## 8-3 Calibration Test Using the Internal Mass

- This function tests the balance accuracy using the internal mass.
- Calibration test does not perform calibration.
- When GLP output is set, the calibration test report is output or stored.

1 Connect the AC adapter and warm up the balance at least one hour.

2 Press and hold the **CAL** key until **[[ in** is displayed, then release the key.

3 The balance measures the zero point. Prevent vibration and drafts to affect the balance.

4 The measured zero point data is displayed.

5 The balance measures the internal mass. Prevent vibration and drafts to affect the balance.

6 The value of the internal mass is displayed. The normal range of the value is as follows:

Model	The internal mass	The normal range
HR-100AZ, HR-150AZ	100.0000 g	±0.2 mg
HR-250AZ	200.0000 g	

7 If GLP output is set, **GLP** is displayed, the calibration test report is output to the RS-232C interfac. Refer to "GLP output (inF0)" of the function table, "11-2. GLP Report".

**End** is displayed after the calibration.

8 The balance automatically returns to the weighing mode.

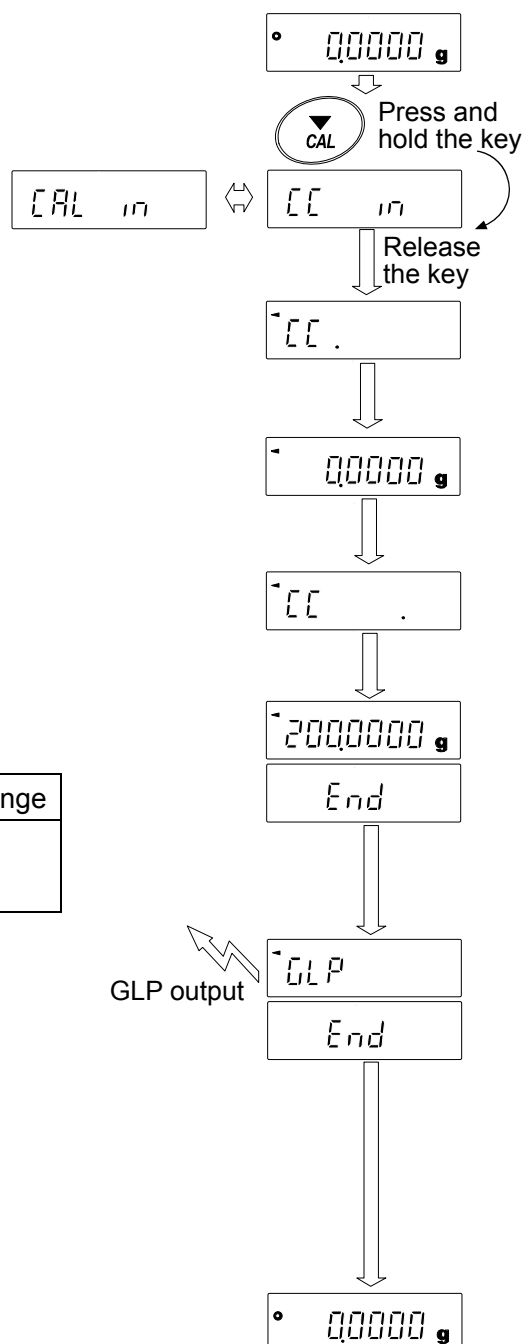

## 8-4 Correcting the Internal Mass Value: 1 (Only for HR-AZ series)

- The HR-AZ series balance can correct the internal mass value using an external weight.  
Method 1: Calibrate the balance using the internal mass. Measure the external weight. Calculate the correction value. And store it in the balance.
- The adjustable range of the internal mass value is as follows:

Model	Correction reference value	Adjustable range
HR-100AZ	100 g	-0.0150 g to +0.0150 g
HR-150AZ	100 g	
HR-250AZ	200 g	

### Operation

Example : Correcting the weight value by +0.0003 g in 100 g using the HR-150AZ.

If correcting the weight value by +0.0003 g in 50 g, use the correction value of +0.0006 g as the correction reference value is 100 g.

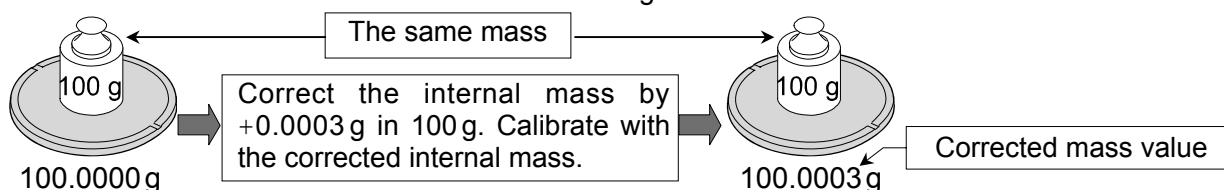

- Perform calibration using the internal mass (one-touch calibration). Place the external weight on the HR-140AZ weighing pan to obtain the correction value.
- With the factory setting, the balance can not correct the internal mass value. Refer to “9. FUNCTION SWITCH AND INITIALIZATION” and set the internal mass value correction switch to 1.
- In the weighing mode, press and hold the **SAMPLE** key to display **bASFnC**.
- Press the **SAMPLE** key several times until **[5 in 1]** is displayed.
- Press the **PRINT** key.  
Correct the internal mass value using the following keys:
 

<b>RE-ZERO</b> key	To increase the value by one.	The balance displays -0.0015g after +0.0015g.
<b>MODE</b> key	To decrease the value by one.	
<b>PRINT</b> key	To store the correction value and display the next menu item of the function table.	
- Press the **CAL** key to return to the weighing mode.
- Press the **CAL** key to perform calibration using the internal mass.
- Confirm that the internal mass value has been corrected properly by placing the external weight on the weighing pan.  
If the internal mass value has not been corrected properly, repeat the procedure to adjust the correction value.

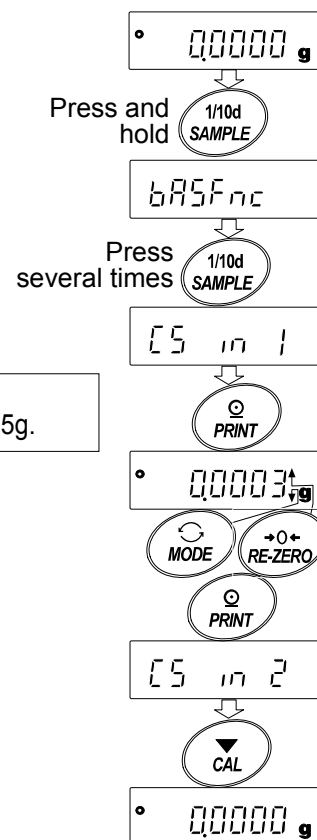

## 8-5 Correcting the Internal Mass Value: 2 (Only for HR-AZ series)

- The HR-AZ series balance can correct the internal mass value using an external weight.  
Method 2: Calibrate the balance using the external weight. The balance performs automatic calibration using the internal mass, corrects the internal mass value and stores it in the balance. The corrected mass value is maintained in non-volatile memory even if the AC adapter is removed.
- The usable calibration weights and the adjustable range are as follows:

Model	Usable calibration weight	Adjustable range
HR-100AZ	<b>100 g</b> , 50 g	-0.0150 g to +0.0150 g
HR-150AZ	150 g, <b>100 g</b> , 50 g	
HR-250AZ	250 g, <b>200 g</b> , 100 g, 50 g	

The calibration weight in bold type: factory setting

The calibration weight value can be adjusted within the range above.

### Operation

- 1 With the factory setting, the balance can not correct the internal mass value. Refer to “9. FUNCTION SWITCH AND INITIALIZATION” and set the internal mass value correction switch to 1.
- 2 In the the weighing mode, press an d hold the **[SAMPLE]** key to display **[bASFnC]**.
- 3 Press the **[SAMPLE]** key several times until **[CS in 2]** is displayed.  
If **[CS in 2]** is not displayed, perform step 1.
- 4 Press the **[PRINT]** key to display **[CAL 0]**.  
Refer to “8-6 Calibration Using an External Weight”, to perform the calibration.
- 5 After calibration, the balance displays **[READY]**.  
Remove the external weight, place the accessory breeze break on the balance and press the **[PRINT]** key.
- 6 **[CAL. SET]** is displayed and the balance corrects the internal mass value automatically
- 7 After correcting the internal mass value, the balance displays **[CAL. in]**, and performs the calibration automatically using the corrected internal mass value.
- 8 The balance displays **[End]** and returns to the weighing mode.
- 9 Confirm that the internal mass value has been corrected properly by placing the external weight used for the correction procedure on the weighing pan.  
If the internal mass value has not been corrected properly, repeat the procedure to adjust the correction value.

Calibration using an external weight

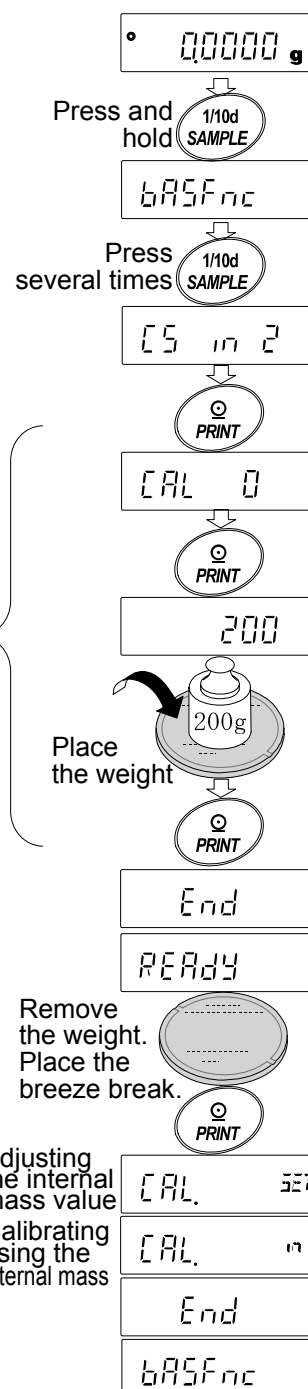

## 8-6 Calibration Using an External Weight

This function calibrates the balance using an external weight.

### Operation

- 1 Connect the AC adapter and warm up the balance for at least one hour with nothing on the pan.
- 2 Press and hold the **CAL** key until **CALout** is displayed, and then release the key.
- 3 The balance displays **CAL 0**.
  - If you want to change the calibration weight (a list of usable weights is shown on page 24), press the **SAMPLE** key and go to step 4.
  - If you use the calibration weight value stored in the balance, go to step 5.
- 4 Specify the calibration weight value as follows:

**SAMPLE** key      To switch the display condition to: "All of weight selection mode) or "The last two digits blinking" (value adjustment mode).

**RE-ZERO** key (To increase the value)

**MODE** key (To decrease the value)

To select the calibration weight or adjust the value.

**PRINT** key

To store the new weight value. Even if the AC adapter is removed, the data is maintained in non-volatile memory.

**CAL** key

To cancel the operation and return to **CAL 0**.

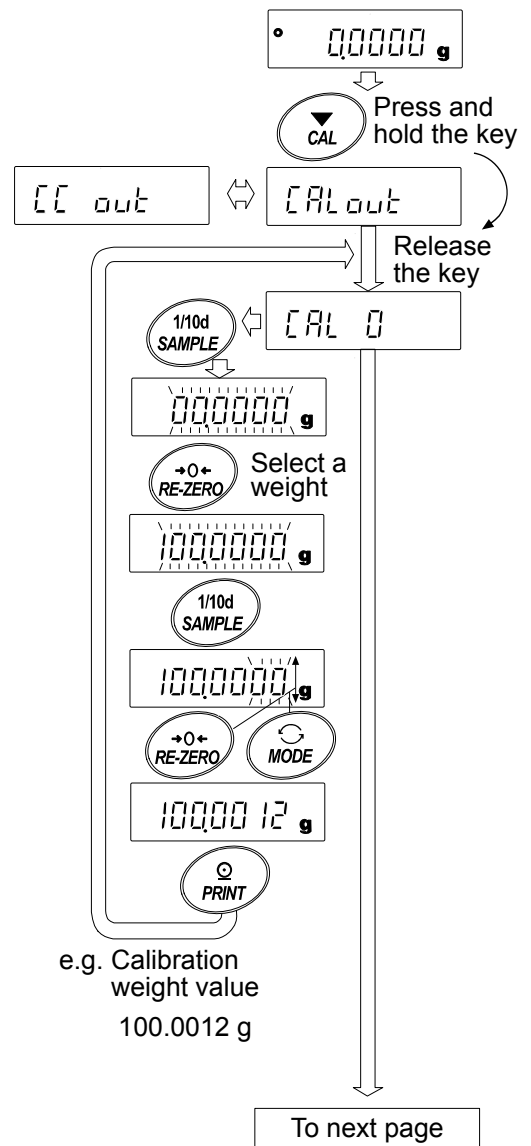

- 5 Confirm that there is nothing on the pan and press the **PRINT** key. The balance measures the zero point. Do not allow vibration or drafts to affect the balance.

The balance displays the calibration weight value.

- 6 Place the displayed calibration weight on the pan and press the **PRINT** key. The balance measures the calibration weight. Do not allow vibration or drafts to affect the balance.

- 7 The balance displays **End**. Remove the weight from the pan.

- 8 When the GLP output is set, the balance displays **GLP** and outputs "Calibration Report".

- 9 The balance will automatically return to the weighing mode.

- 10 Place the calibration weight on the pan and confirm that the value displayed is within  $\pm 2$  digits of the specified value. If it is not within the range, check the ambient conditions such as drafts and vibration, also check the weighing pan. Then, repeat steps 1 to 9.

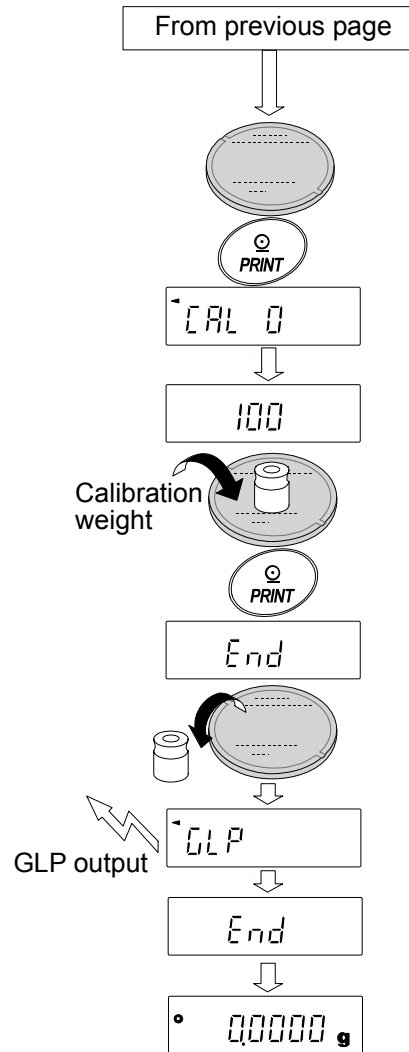



## 8-7 Calibration Test Using an External Weight

This function tests the balance weighing accuracy using an external weight and outputs the result. This is available only when the “GLP output (INF0)” parameter is set to “1” or “2”. (Calibration test does not perform calibration.)

### Operation

- 1 Connect the AC adapter and warm up the balance for at least one hour with nothing on the pan.
- 2 Press and hold the **CAL** key until **[[out** is displayed, and then release the key.
- 3 The balance displays **[[ 0**.
  - If you want to change the target weight (a list of usable weights is shown on page 24), press the **SAMPLE** key and go to step 4.
  - If you use the target weight value stored in the balance, go to step 5.
- 4 Specify the target weight value as follows:

**SAMPLE** key To switch the display condition to: “All of the segments blinking” (target weight selection mode) or “The last two digits blinking” (value adjustment mode).

**RE-ZERO** key (To increase the value)

**MODE** key (To decrease the value)

To select the target weight or adjust the value.

**PRINT** key

To store the new weight value. Even if the AC adapter is removed, the data is maintained in non-volatile memory.

**CAL** key

To cancel the operation and return to **[[ 0**.

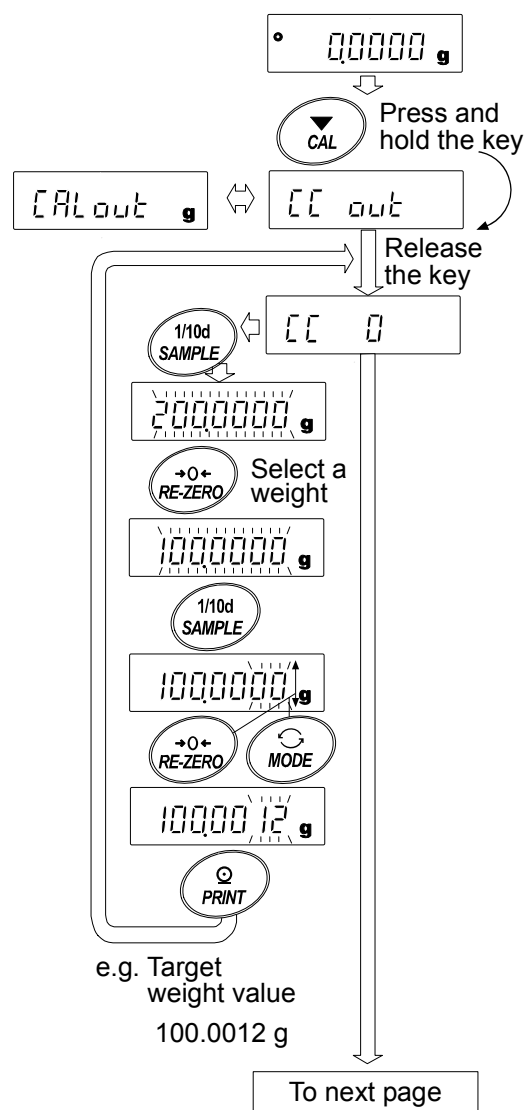

5 Confirm that there is nothing on the pan and press the **PRINT** key. The balance measures the zero point and displays the measured value. Do not allow vibration or drafts to affect the balance.

The balance displays the target weight value.

6 Place the displayed target weight on the pan and press the **PRINT** key. The balance measures the target weight and displays the measured value. Do not allow vibration or drafts to affect the balance.

7 The balance displays **End**. Remove the weight from the pan.

8 When the GLP output is set, the balance displays **GLP** and outputs "Calibration Test Report".

9 The balance will automatically return to the weighing mode.

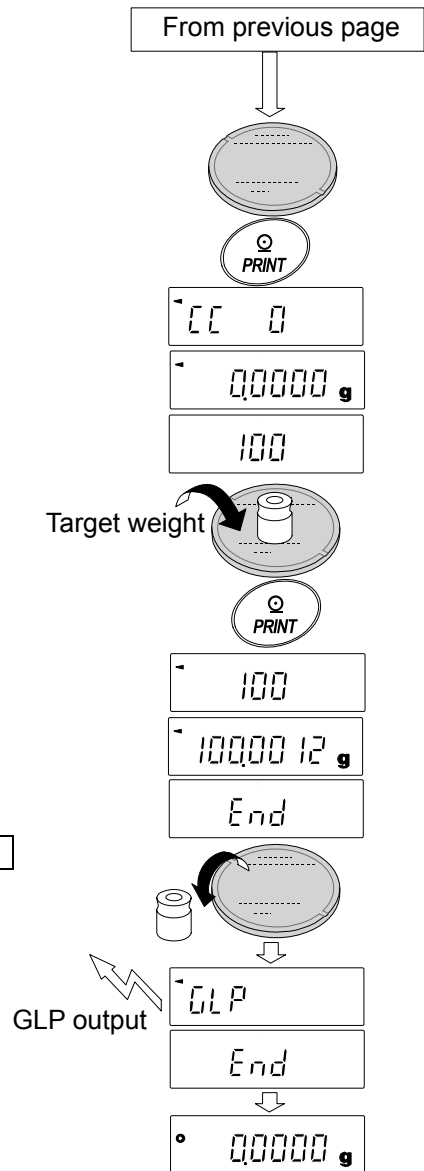

# 9. FUNCTION SWITCH AND INITIALIZATION

## 9-1 Permit or Inhibit

The balance stores parameters that must not be changed unintentionally. There are two switches for the purpose of protecting these parameters. Each switch can select either “permit” or “inhibit”. The “inhibit” protects parameters against unintentional operations.

### Switches (HR-AZ series)

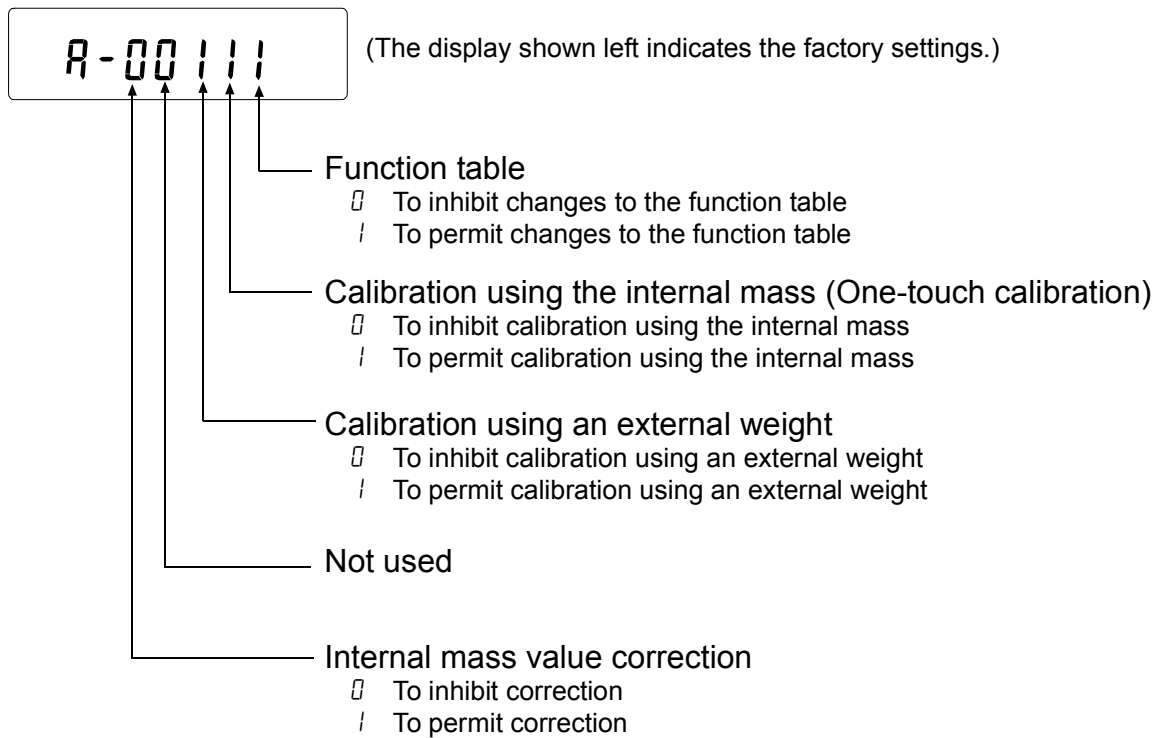

### Switches (HR-A series)

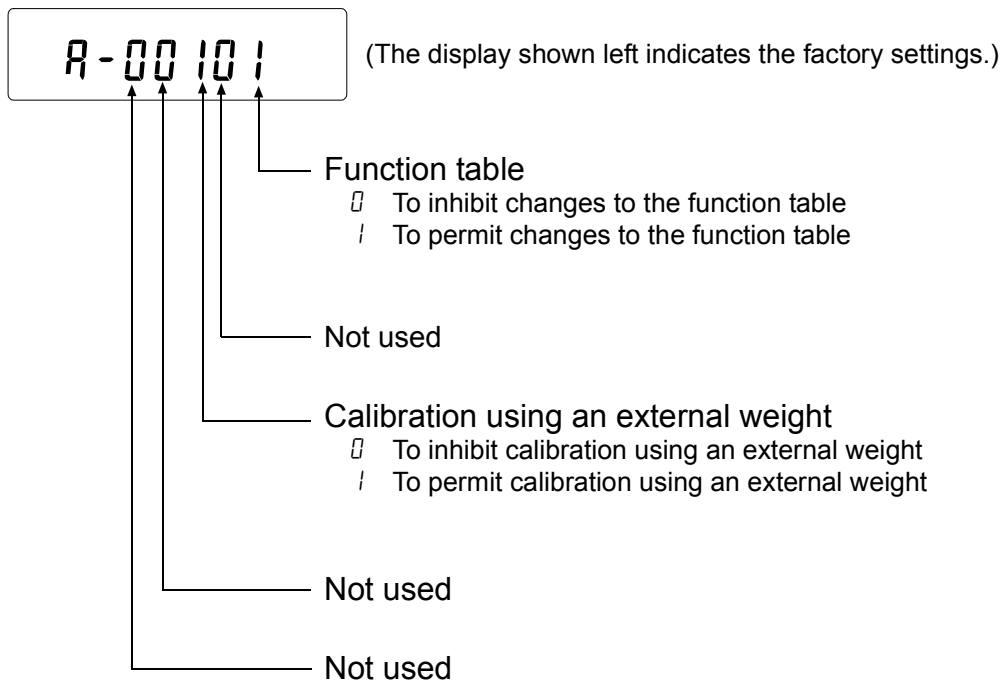

## Operation

- 1 Press the **ON:OFF** key to turn off the display.
- 2 While pressing and holding the **PRINT** key and the **SAMPLE** key, press the **ON:OFF** key. The balance displays **PS**.
- 3 Press the **PRINT** key. Then the balance displays the function switches.
- 4 Set the switches using the following keys.

**SAMPLE** key To select the switch to change the parameter. The selected switch blinks.

**RE-ZERO** key To change the parameter of the switch selected.

**0**:To inhibit changes. **1**:To permit changes

**PRINT** key To store the new parameter and return to the weighing mode.

**CAL** key To cancel the operation ( **ELr** is displayed.) To return to the weighing mode, press the **CAL** key once again.

## 9-2 Initializing the Balance

This function returns the following parameters to factory settings.

- Calibration data
- Function table
- The sample unit mass value (counting mode), 100% reference mass value (percent mode)
- External calibration weight
- Function switch settings
- Statistical data
- Internal mass value (Only for the HR-AZ series)

### Note

**Be sure to calibrate the balance after initialization.**

### Operation

- 1 Press the **ON:OFF** key to turn off the display.
- 2 While pressing and holding the **PRINT** key and the **SAMPLE** key, press the **ON:OFF** key. The balance displays **PS**.
- 3 Press the **SAMPLE** key to display **ELr**.
- 4 Press the **PRINT** key.  
To cancel this operation, press the **CAL** key.
- 5 Press the **RE-ZERO** key.
- 6 Press the **PRINT** key to initialize the balance.  
The balance will automatically return to the weighing mode.

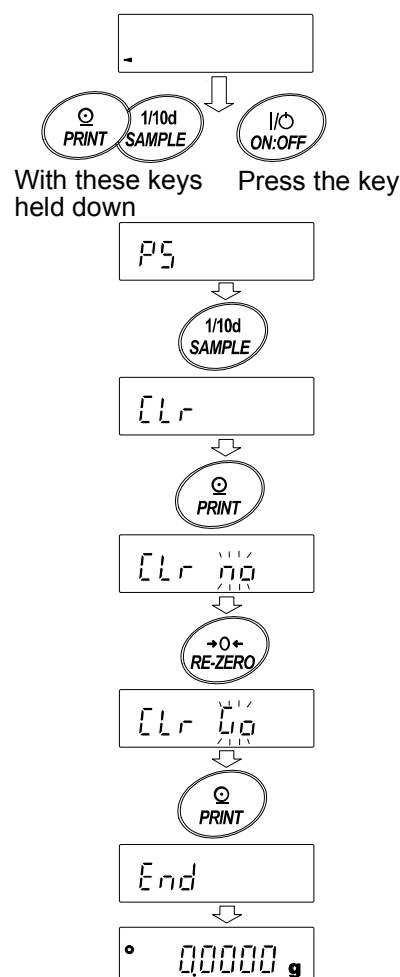

# 10. FUNCTION TABLE

The function table reads or rewrites the parameters that are stored in the balance. These parameters stored, even if the AC adapter is removed, are maintained in non-volatile memory.

## 10-1 Structure and Sequence of the Function Table

The function table menu consists of two layers. The first layer is the “Class” and the second layer is the “Item”. Each item stores a parameter.

### Example



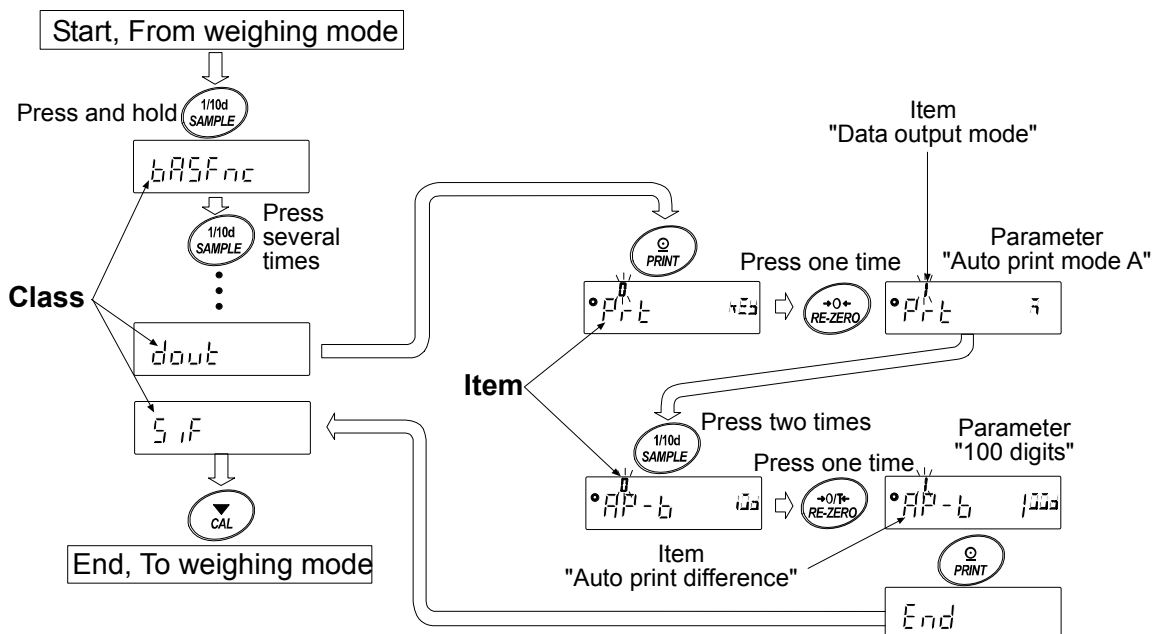

This example sets “Auto print mode A” for “Data output mode” and “100 digits” for “Auto print difference”.



## 10-2 Display and Keys

Display/Key	Description
	The symbol “” indicates that the parameter displayed is in effect.
	When pressed and held in the weighing mode, enters the function table mode. Selects the class or item in the function table mode.
	Changes the parameter.
	When a class is displayed, moves to an item in the class. When an item is displayed, stores the new parameter and displays the next class.
	When an item is displayed, cancels the new parameter and displays the next class. When a class is displayed, exits the function table mode and returns to the weighing mode.

## 10-3 Details of the Function Table

Class	Item and Parameter	Description			
bRSFnc Environment Display	Cond Condition	0	Fast response, sensitive value	  	With "Hold 1", sets the averaging time.
		1			
	2	Slow response, stable value			
	St-b Stability band width	0	Stable range is ±1 digit		The stabilization indicator illuminates when the display fluctuation is within the range. With "Hold 1", sets the stabilization range.
		1	Stable range is ±3 digits		
	Hold Hold function	0		OFF	Holds the display when stable in animal mode. With "Hold 1", [HOLD] turns on.
		1	ON		
	Zrc Zero tracking	0	OFF	Keeps zero display by tracking zero drift.	
		1	Normal		
		2	Strong		
	SPd Display refresh rate	0	5 times/second	Period to refresh the display	
		1	10 times/second		
		2	Very strong		
	Pnt Decimal point	0	Point (.)	Decimal point format	
1		Comma (,)			
P-on Auto display-ON	0	OFF	Turns on the weighing mode display when the AC adapter is connected.		
	1	ON			
POFF Auto display-OFF	0	OFF	Turns off the display after 10 minutes of inactivity.		
	1	ON (10 minutes)			
rnG Display at start	0	Displays	Select whether or not to display the minimum weighing value at weighing start.		
	1	Does not display			
bEEP Beep	0	Does not sound	Select whether or not to sound the beep when operating on keys.		
	1	Sounds			
CL Add* Clock	Refer to "10-9 Clock and calendar function".		Confirms and sets the time and date. The time and date are added to output data.		
CP Fnc Comparator	CP Comparator mode	0	No comparison		
		1	Comparison, excluding "near zero" when stable value or overloaded		
		2	Comparison, including "near zero" when stable value or overloaded		
		3	Continuous comparison, excluding "near zero"		
		4	Continuous comparison, including "near zero"		
	bEP- LO buzzer	0	OFF		
		1	ON		
	bEP- OK buzzer	0	OFF		
		1	ON		
	bEP- HI buzzer	0	OFF		
1		ON			

■: Factory settings. Digit is a unit of minimum weighing value

\*: Only for the HR-AZ series

Class	Item and Parameter	Description		
$\overline{CP} H_1$ Upper limit		Refer to "10-10 Comparator Function".		
$\overline{CP} L_0$ Lower limit				
<i>dout</i> Data output	$P_{rL}$ Data output mode	0	Key mode	Accepts the [PRINT] key only when the display is stable.
		1	Auto print mode A (Reference = zero)	Outputs data when the display is stable and conditions of $RP-P$ , $RP-b$ and the reference value are met.
		2	Auto print mode B (Reference = last stable value)	
		3	Stream mode	Outputs data continuously.
		4	Key mode B (Immediately)	Accepts the [PRINT] key regardless of the display condition.
		5	Key mode C (When stable)	Accepts the [PRINT] key immediately when the display is stable, or waits for the display to be stable when not.
		6	Interval output mode	Uses interval output mode.
	$RP-P$ Auto print polarity	0	Plus only	Displayed value > Reference
		1	Minus only	Displayed value < Reference
		2	Both	Regardless of displayed value
	$RP-b$ Auto print difference	0	10 digits	Difference between reference value and displayed value
		1	100 digits	
		2	1000 digits	
	$int$ Interval time	0	Every measurement	Interval time for the interval output mode (With $P_{rL}$ 3)
		1	2 seconds	
		2	5 seconds	
		3	10 seconds	
		4	30 seconds	
		5	1 minute	
		6	2 minute	
		8	10 minute	
	$S-t_d^*$ Time/Date output	0	No output	
		1	Time only	
		3	Date only	
		4	Time and date	
	$S-id$ ID number output	0	No output	Selects whether or not the ID number is output.
		1	Output	
	$PUSE$ Data output pause	0	No pause	Selects the data output interval.
1		Pause (1.6 seconds)		
$RF-F$ Auto feed	0	Not used	Selects whether or not automatic feed is performed.	
	1	Used		
$inf_0$ GLP output	0	No output	Selects GLP output method.	
	1	AD-8121 format		
	2	General data format		
$Rr-d$ Zero after output	0	Not used	Adjusts zero automatically after data is output	
	1	Used		

▪ Factory settings. Digit is a unit of minimum weighing value  
\* : Only for the HR-AZ series

Class	Item and Parameter	Description		
SIF Serial interface	bPS Baud rate	0	600 bps	
		1	1200 bps	
		▪ 2	2400 bps	
		3	4800 bps	
		4	9600 bps	
		5	19200 bps	
	bPr Data bit, parity bit	▪ 0	7 bits, even	
		1	7 bits, odd	
		2	8 bits, none	
	ErLF Terminator	▪ 0	CR LF	CR: ASCII code 0Dh LF: ASCII code 0Ah
		1	CR	
	tYPE Data format	▪ 0	A&D standard format	Refer to "10-6 Description of the Item "Data Format".
		1	DP format	
		2	KF format	
3		MT format		
4		NU format		
5		CSV format		
t-UP Timeout	0	No limit	Selects the wait time to receive a command.	
	▪ 1	1 second		
ErEd AK, Error code	▪ 0	No output	AK:ASCII code 06h	
	1	Output		
nLt Programmable-unit (Multi-unit)	Sets an arbitrary coefficient.		Available only when programmable-unit mode is selected.	
Unit	Refer to "5. WEIGHING UNITS".			
ID ID number	Refer to "11. ID NUMBER AND GLP REPORT"			
AP Fnc Application	APP Application function	▪ 0	Normal weighing mode	
		1	Capacity indicator	
		2	Statistical calculation mode	
	SEPF Statistical function mode output items	▪ 0	Number of data, sum	
		1	Number of data, sum, maximum, minimum, average, range (maximum-minimum)	
		2	Number of data, sum, maximum, minimum, average, range (maximum-minimum), standard deviation, coefficient of variation	
		3	Number of data, sum, maximum, minimum, average, range (maximum-minimum), standard deviation, coefficient of variation, relative error	
[5 in 1* Internal mass value correction: Method 1		Refer to "8. CALIBRATION".		Displayed only when the function switch (internal mass value correction switch) is set to 1.
[5 in 2* Internal mass value correction: Method 2				

\* : Only for the HR-AZ series      ▪ : Factory settings.

### Caution

The balance may not transmit the data completely at the specified refresh rate, depending on the baud rate.

When a refresh rate of 20 times/second is used, set the baud rate to 4800 bps or higher.



## 10-4 Description of the Class “Environment, Display”

### Condition ( $\text{Cond}$ )

$\text{Cond } 0$



$\text{Cond } 2$

This parameter is for sensitive response to the fluctuation of a weight value. Used for powder target weighing, weighing a very light sample or when quick response weighing is required.

After setting, the balance displays **FAST**.

This parameter is for stable weighing with slow response. Used to prevent a weight value from drifting due to vibration or drafts.

After setting, the balance displays **SLOW**.

#### Note

With “Hold function ( $\text{Hold}$ )” set to “ON (  $1$  )”, this item is used to set the averaging time.

### Stability band width ( $\text{St-b}$ )

This item controls the width to regard a weight value as a stable value. When the fluctuation per second is less than the parameter, the balance displays the stabilization indicator and outputs the data. The parameter influences the “Auto print mode”

$\text{St-b } 0$



$\text{St-b } 2$

This parameter is for sensitive response of the stabilization indicator. Used for exact weighing.

This parameter ignores slight fluctuation of a weight value. Used to prevent a weight value from drifting due to vibration or drafts.

#### Note

With “Hold function ( $\text{Hold}$ )” set to “ON (  $1$  )”, this item is used to set the stabilization range.

### Hold function ( $\text{Hold}$ ) (Animal weighing mode)

This function is used to weigh a moving object such as an animal.

When the weight data is over the weighing range from zero and the display fluctuation is within the stabilization range for a fixed period of averaging time, the processing indicator illuminates and the balance displays the average weight of the animal. When the animal is removed from the weighing pan, the display returns to zero automatically.

This function is available only when the hold function parameter is set to “  $1$  ” (the animal mode indicator **HOLD** illuminates) and any weighing unit other than the counting mode is selected.

The stabilization range and averaging time are set in “Condition (  $\text{Cond}$  )” and “Stability band width (  $\text{St-b}$  )”.

Weighing range		Averaging time		Stabilization range	
HR-100A / 150A / 250A	0.0200 g	$\text{Cond } 0$	2 seconds Faster	$\text{St-b } 0$	6.25% Lesser
HR-100AZ / 150AZ / 250AZ	or over	$\text{Cond } 1$	4 seconds	$\text{St-b } 1$	12.5%
		$\text{Cond } 2$	8 seconds More accurate	$\text{St-b } 2$	16.7% Greater

### **Zero tracking ( *t<sub>rc</sub>* )**

This function tracks zero point drift caused by changes in the environment and stabilizes the zero point. When the weight data is only a few digits, turn the function off for accurate weighing.

#### **Note**

**Digit indicates a unit of minimum weighing value.**

<i>t<sub>rc</sub></i> 0	The tracking function is not used. Used for weighing a very light sample.
<i>t<sub>rc</sub></i> 1	The tracking function is used. Normal zero tracking.
<i>t<sub>rc</sub></i> 2	The tracking function is used. Strong zero tracking.
<i>t<sub>rc</sub></i> 3	The tracking function is used. Very strong zero tracking.

### **Display refresh rate ( *SP<sub>d</sub>* )**

Period to refresh the display. This parameter influences “Stream mode” along with “Baud rate” and “Data output pause”

#### **Note**

**This item is selected automatically when the response rate is changed.**

### **Decimal point ( *P<sub>nt</sub>* )**

The decimal point format can be selected.

### **Auto display-ON ( *P<sub>on</sub>* )**

When the AC adapter is connected, the display is automatically turned on in the weighing mode, without the ON:OFF key operation. Used when the balance is built into an automated system. One hour warm up is necessary for accurate weighing.

### **Auto display-OFF ( *P<sub>off</sub>* )**

This function automatically turns off the balance display, if the weighing value is 0.5 g or less and the balance is in the no key operation or no command has been received for approx. 10 minutes.

(The balance has the same power requirement in the weighing state as in the off state (standby mode).)

## 10-5 Description of the Item “Data Output Mode”

The parameter setting of the “Data output mode ( *Prt* )” applies to the performance when the data is transmitted using the RS-232C serial interface.

### Key mode

When the **PRINT** key is pressed with the stabilization indicator turned on, the balance outputs the weight data and the display blinks one time.

Required setting	<i>dout</i>	<i>Prt 0</i>	Key mode
------------------	-------------	--------------	----------

### Auto print modes A and B

When the displayed value is stable and the conditions of “Auto print polarity”, “Auto print difference” and reference value are met, the balance outputs the weight data.

When the **PRINT** key is pressed with the stabilization indicator turned on, the balance outputs the data and the display blinks one time.

Mode A: Required setting	<i>dout</i>	<i>Prt 1</i>	Auto print mode A (reference = zero)
	<i>dout</i>	<i>RP-P</i>	Auto print polarity
	<i>dout</i>	<i>RP-b</i>	Auto print difference

Example	“For outputting the weight value each time a sample is added, with “ <i>Rr-d</i> ” set to “1” (to adjust zero after the data is output).”
---------	---

Mode B: Required setting	<i>dout</i>	<i>Prt 2</i>	Auto print mode B (reference = last stable value)
	<i>dout</i>	<i>RP-P</i>	Auto print polarity
	<i>dout</i>	<i>RP-b</i>	Auto print difference

Example	“For outputting the weight value while a sample is added.”
---------	--

### Stream mode

The balance outputs the weight data continuously regardless of the display condition. The display does not blink in this mode.

Required setting	<i>dout</i>	<i>Prt 3</i>	Stream mode
	<i>bRSFnc</i>	<i>SPd</i>	Display refresh rate
	<i>S iF</i>	<i>bPS</i>	Baud rate

Example	“For monitoring data on a computer”
---------	-------------------------------------

### Caution

**The balance may not transmit the data completely at the specified refresh rate and baud rate. Set the baud rate higher.**

### Key mode B

When the **PRINT** key is pressed, the balance outputs the weight data, regardless of the display condition. The display does not blink in this mode.

### Key mode C

When the **PRINT** key is pressed with the stabilization indicator turned on, the balance outputs the weight data. When the stabilization indicator is not on, the balance waits for the indicator to turn on and outputs the data. The balance blinks one time in this mode.

## Interval output mode

The weight data is periodically output.

When the **PRINT** key is pressed, the balance starts to output the weight data at a preset interval time. When the **PRINT** key is pressed again, the balance stops outputting the weight data.

Required setting	<i>dout</i>	<i>Prt 6</i>	Interval output mode
	<i>dout</i>	<i>int</i>	Interval time

Example "For outputting the weight data periodically."

### Caution

**The balance may not transmit the data completely at the specified interval times and baud rate. Set the baud rate higher.**

## 10-6 Description of the Item "Data Format"

### A&D standard format *S,F TYPE 0*

This format is used when the peripheral equipment can receive the A&D format. If an AD-8121B is used, set the printer to MODE 1 or 2.

- This format consists of fifteen characters excluding the terminator.
- A header of two characters indicates the balance condition.
- The polarity sign is placed before the data with the leading zeros. If the data is zero, the plus sign is used.
- The unit, consisting of three characters, follows the data.

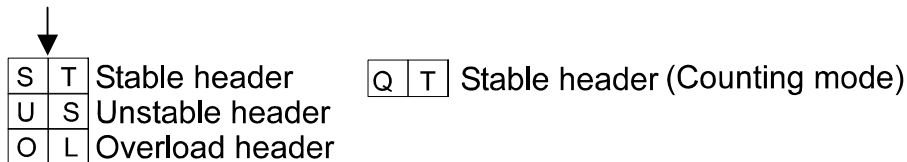
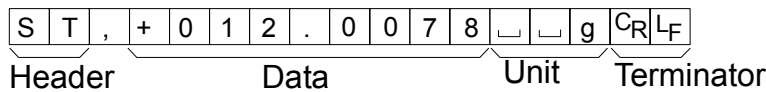

### DP (Dump print) format *S,F TYPE 1*

This format is used when the peripheral equipment can not receive the A&D format. If an AD-8121B is used, set the printer to MODE 3.

- This format consists of sixteen characters excluding the terminator.
- A header of two characters indicates the balance condition. No overload header is used.
- The polarity sign is placed before the data, with spaces in place of leading zeros, if the data is not zero or overloaded.
- The unit, consisting of three characters, follows the data.

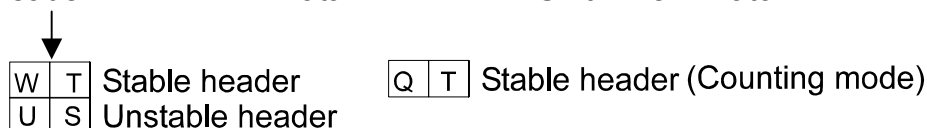
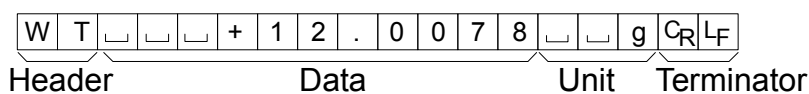

### KF format *S, F TYPE 2*

This is the Karl-Fischer moisture meter format and is used when the peripheral equipment can only communicate using this format.

- This format consists of fourteen characters excluding the terminator.
- This format has no header characters.
- The polarity sign is placed before the data, with spaces in place of leading zeros, if the data is not zero or overloaded.
- This format outputs the unit only for a stable value.

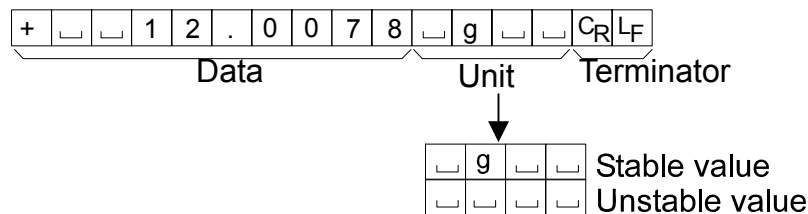

### MT format *S, F TYPE 3*

- A header of two characters indicates the balance condition.
- The polarity sign is used only for negative data.
- The weight data uses spaces in place of the leading zeros.
- The character length of this format changes dependent upon the unit

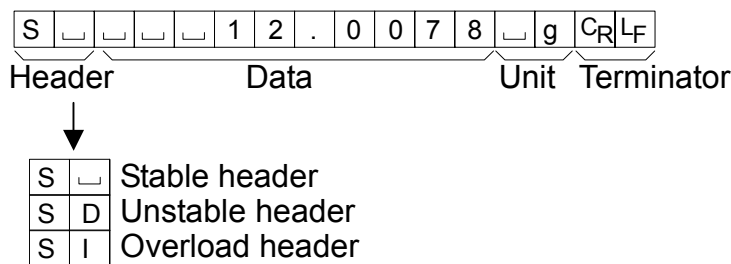

### NU (numerical) format *S, F TYPE 4*

This format outputs only numerical data.

- This format consists of nine characters excluding the terminator.
- The polarity sign is placed before the data with the leading zeros. If the data is zero, the plus sign is used.

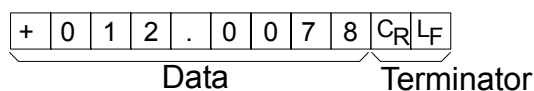

### CSV format *S, F TYPE 5*

- Separates the data of A&D standard format and the unit by a comma (,).
- Outputs the unit even when the data is overloaded.

ST,+012.0078,  g<CR><LF>  
Weight data

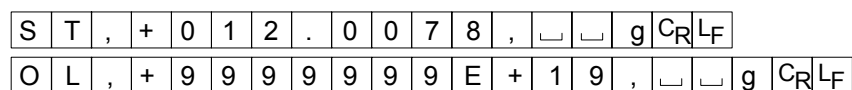

**Date** *dout 5-td 2 or 3*

- The date output order can be changed in "Clock (CL Add)".
- The year is output in a four-digit format.

1	2	/	3	1	/	2	0	1	0	C <sub>R</sub>	L <sub>F</sub>
---	---	---	---	---	---	---	---	---	---	----------------	----------------

**Time** *dout 5-td 1 or 3*

- The time is output in a 24-hour format.

1	2	:	3	4	:	5	6	C <sub>R</sub>	L <sub>F</sub>
---	---	---	---	---	---	---	---	----------------	----------------

## 10-7 Data Format Examples

---

**Stable**

° 18.127<sub>g</sub>

A&D	S	T	,	+	0	0	1	.	8	1	2	7	␣	␣	g	C <sub>R</sub>	L <sub>F</sub>	
DP	W	T	␣	␣	␣	␣	+	1	.	8	1	2	7	␣	␣	g	C <sub>R</sub>	L <sub>F</sub>
KF	+	␣	␣	␣	1	.	8	1	2	7	␣	g	␣	␣	C <sub>R</sub>	L <sub>F</sub>		
MT	S	␣	␣	␣	␣	␣	1	.	8	1	2	7	␣	g	C <sub>R</sub>	L <sub>F</sub>		
NU	+	0	0	1	.	8	1	2	7	C <sub>R</sub>	L <sub>F</sub>							

**Unstable**

-18.376<sub>g</sub>

A&D	U	S	,	-	0	1	8	.	3	7	6	9	␣	␣	g	C <sub>R</sub>	L <sub>F</sub>		
DP	U	S	␣	␣	␣	␣	-	1	8	.	3	7	6	9	␣	␣	g	C <sub>R</sub>	L <sub>F</sub>
KF	-	␣	␣	␣	1	8	3	.	6	9	␣	␣	␣	␣	C <sub>R</sub>	L <sub>F</sub>			
MT	S	D	␣	␣	␣	␣	-	1	8	3	.	6	9	␣	g	C <sub>R</sub>	L <sub>F</sub>		
NU	-	0	0	1	8	3	.	6	9	C <sub>R</sub>	L <sub>F</sub>								

**Overload**  
Positive error

⊘<sub>g</sub>

A&D	O	L	,	+	9	9	9	9	9	9	9	9	E	+	1	9	C <sub>R</sub>	L <sub>F</sub>
DP	␣	␣	␣	␣	␣	␣	␣	␣	␣	E	␣	␣	␣	␣	␣	␣	C <sub>R</sub>	L <sub>F</sub>
KF	␣	␣	␣	␣	␣	␣	H	␣	␣	␣	␣	␣	␣	␣	␣	C <sub>R</sub>	L <sub>F</sub>	
MT	S	I	+	C <sub>R</sub>	L <sub>F</sub>													
NU	+	9	9	9	9	9	9	9	9	C <sub>R</sub>	L <sub>F</sub>							

**Overload**  
Negative error

-⊘<sub>g</sub>

A&D	O	L	,	-	9	9	9	9	9	9	9	E	+	1	9	C <sub>R</sub>	L <sub>F</sub>
DP	␣	␣	␣	␣	␣	␣	␣	-	E	␣	␣	␣	␣	␣	␣	C <sub>R</sub>	L <sub>F</sub>
KF	␣	␣	␣	␣	␣	␣	L	␣	␣	␣	␣	␣	␣	␣	␣	C <sub>R</sub>	L <sub>F</sub>
MT	S	I	-	C <sub>R</sub>	L <sub>F</sub>												
NU	-	9	9	9	9	9	9	9	9	C <sub>R</sub>	L <sub>F</sub>						

- ␣ Space, ASCII 20h
- C<sub>R</sub> Carriage Return, ASCII 0Dh
- L<sub>F</sub> Line Feed, ASCII 0Ah

Units		A&D	D.P.	KF	MT
g	g	□□g	□□g	□g□□	□g
mg	mg	□mg	□mg	□mg□	□mg
Counting mode	PCS	□PC	□PC	□pc s	□PCS
Precent mode	%	□□%	□□%	□%□□	□%
Ounce (Avoir)	oz	□oz	□oz	□oz□	□oz
Troy Ounce	ozt	ozt	ozt	□ozt	□ozt
Metric Carat	ct	□ct	□ct	□ct□	□ct
Momme	mom	mom	mom	□mom	□mo
Pennyweight	dwt	dwt	dwt	□dwt	□dwt
Grain	GN	□GN	□GN	□gr□	□GN
Tael (HK general, Singapore)	tl	□tl	□tl	□t l s	□tl
Tael (HK, jewelry)	tl	□tl	□tl	□t l h	□tl
Tael (Taiwan)	tl	□tl	□tl	□t l t	□tl
Tael (China)	tl	□tl	□tl	□t l c	□tl
Tola (India)	tol	□□t	□□t	□t o l	□t
Messghal	MES	mes	mes	□MS□	□m
Multi	MLT	MLT	MLT	□MLT	□MLT

□ Space, ASCII 20h

#### Note

When “Pound Ounce” is selected, the data is output with the unit of ounce (oz).

## 10-8 Description of the Item “Application Function”

---

### Capacity indicator (APF 1)

In the weighing mode, the indicator displays the weight data relative to the weighing capacity in percentage. (Zero = 0%, maximum capacity = 100%)

### Statistical calculation mode (APF 2)

The mode statistically calculates the weight data, and displays or outputs the results. For details, refer to “6-4 Statistical Calculation Mode”.

## 10-9 Clock and Calendar Function (Only for HR-AZ series)

The HR-AZ series balance is equipped with a clock and calendar function. When the “GLP output (Inf<sub>o</sub>)” parameter is set to “1” or “2” and the “Time/Date output (S-t<sub>d</sub>)” parameter is set to “1”, “2” or “3”, the time and date are added to the output data. Set or confirm the time and date as follows:

### Operation

- 1 Press and hold the **SAMPLE** key until **bRSFnC** of the function table is displayed.
- 2 Press the **SAMPLE** key several times to display **EL Add**.
- 3 Press the **PRINT** key. The balance enters the mode to confirm or set the time and date.

### Confirming the date

- 4 The current date is displayed with all the digits blinking.
  - When the date is correct and the operation is to be finished, press the **CAL** key and go to step 8.
  - When the date is correct and the time is to be confirmed, press the **SAMPLE** key and go to step 6.
  - When the date is not correct and is to be changed, press the **RE-ZERO** key and go to step 5.

### Note

The year is expressed using a two-digit format. For example, the year 2010 is expressed as “10”.

### Setting the date (with part of the digits blinking)

- 5 Set the date using the following keys.

<b>SAMPLE</b> key	To select the digits to change the value. The selected digits blink.
<b>RE-ZERO</b> key	To increase the value by one.
<b>MODE</b> key	To decrease the value by one.
<b>PRINT</b> key	To store the new setting, display <b>End</b> and go to step 6.
<b>CAL</b> key	To cancel the new setting and go to step 6.

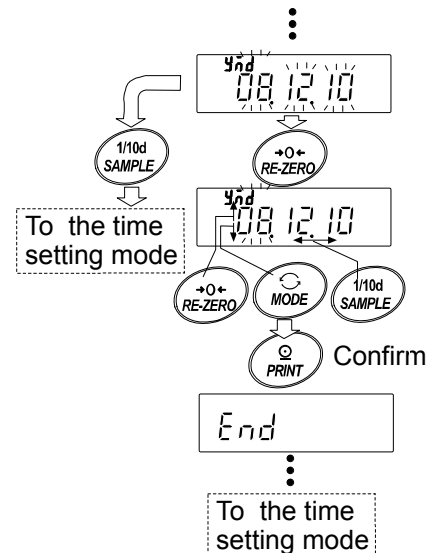



### Confirming the time

- 6 The current time is displayed with all the digits blinking.
- When the time is correct and the date does not need to be confirmed, press the **CAL** key and go to step 8.
  - When the time is correct and the date is to be confirmed, press the **SAMPLE** key and go back to step 4.
  - When the time is not correct and is to be changed, press the **RE-ZERO** key and go to step 7.

### Setting the time (with part of the digits blinking)

- 7 Set the time in a 24-hour format using the following keys.

<b>SAMPLE</b> key	To select the digits to change the value. The selected digits blink.
<b>RE-ZERO</b> key	To increase the value by one.
<b>MODE</b> key	To decrease the value by one.
<b>PRINT</b> key	To store the new setting, display <b>End</b> and go to step 8.
<b>CAL</b> key	To cancel the new setting and go back to step 4.

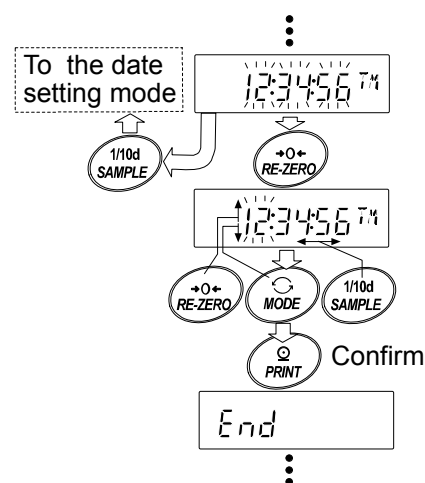

### Quitting the operation

- 8 The balance displays the next menu of the function table. Press the **CAL** key to exit the clock and calendar function and return to the weighing mode.

### Notes

- Do not enter invalid values such as a non-existing date when setting the time and date.

## 10-10 Comparator Function

The results of the comparison are indicated by **HI** **OK** **LO** on the display.

Operating conditions:

- No comparison

- Comparison when the weight data is stable or overloaded, excluding “near zero”
- Comparison when the weight data is stable or overloaded, including “near zero”
- Continuous comparison, excluding “near zero”
- Continuous comparison, including “near zero”

To compare, use:

- Upper limit value and lower limit value

Input method:

- Digital input

### Note

**“Near zero” means that the weight value is within  $\pm 10$  digits of the minimum weighing value. For example, using an HR-250AZ in gram mode, the range of  $\pm 0.0010$  g is “near zero”.**

For the description of “Comparator (CP Fnc)”, refer to “10-3 Details of the Function Table”.

### Setting example

(Continuous comparison, excluding “near zero”, upper limit and lower limit values, digital input)

#### Selecting a comparator mode

- 1 Press and hold the **SAMPLE** key until **bRSFnc** of the function table is displayed.
- 2 Press the **SAMPLE** key several times to display **CP Fnc**.
- 3 Press the **PRINT** key.
- 4 Press the **RE-ZERO** key several times to display **CP 3**.
- 5 Press the **PRINT** key to store the selected mode.

#### Entering the upper limit value

- 6 With **CP Hi** displayed, press the **PRINT** key. The current setting of the upper limit value is displayed with all the digits blinking.
  - When the current setting is not to be changed, press the **PRINT** or **CAL** key to go to step 7.
  - When the current setting is to be changed, press the **RE-ZERO** key. Change the setting using the following keys.

<b>SAMPLE</b> key	To select the digit to change the value. The selected digit blinks.
<b>RE-ZERO</b> key	To change the value of the digit selected.
<b>MODE</b> key	To switch the polarity.
<b>PRINT</b> key	To store the new setting and go to step 7.
<b>CAL</b> key	To cancel the new setting and go to step 7.

#### Entering the lower limit value

- 7 With **CP Lo** displayed, press the **PRINT** key. The current setting of the lower limit value is displayed with all the digits blinking.
  - When the current setting is not to be changed, press the **PRINT** or **CAL** key to go to step 8.
  - When the current setting is to be changed, press the **RE-ZERO** key. Change the setting using the following keys.

<b>SAMPLE</b> key	To select the digit to change the value. The selected digit blinks.
<b>RE-ZERO</b> key	To change the value of the digit selected.
<b>MODE</b> key	To switch the polarity.
<b>PRINT</b> key	To store the new setting and go to step 8.
<b>CAL</b> key	To cancel the new setting and go to step 8.

- 8 Press the **CAL** key to exit the comparator function and return to the weighing mode.

# 11. ID NUMBER AND GLP REPORT

- The ID number is used to identify the balance when Good Laboratory Practice (GLP) is used.
- The ID number is maintained in non-volatile memory even if the AC adapter is removed.
- The GLP output format is selected at “GLP output ( *inF0* )” of the function table and can be output to a personal computer or printer using the RS-232C serial interface.
- The GLP output format includes the balance manufacturer, model, serial number, ID number and space for signature for weight data, and the weight used and results for calibration or calibration test data.

When the AD-8121B is used, the date and time can be printed using the AD-8121B clock and calendar function. In this case, set the “GLP output ( *inF0* )” parameter to “1”.

- The balance can output the following reports for GLP.
  - “Calibration report” of the calibration, using the internal mass (Calibration due to changes in temperature and one-touch calibration.)
  - “Calibration report” of the calibration, using an external weight.
  - “Calibration test report” of the calibration test, using an external weight.
  - “Title block” and “End block” for the weight data.

## 11-1 Setting the ID Number

- 1 Press and hold the **SAMPLE** key until **bASFnC** of the function table is displayed.
- 2 Press the **SAMPLE** key several times to display **id**.
- 3 Press the **PRINT** key. Set the ID number using the following keys.
  - SAMPLE** key      To select the digit to change the value. The selected digit blinks.
  - RE-ZERO** key      To set the character of the digit selected. Refer to the display character set shown below.
  - PRINT** key      To store the new ID number and display **RP FnC**
  - CAL** key      To cancel the new ID number and display **RP FnC**
- 4 Press the **CAL** key to return to the weighing mode.

### Display character set

0	1	2	3	4	5	6	7	8	9	-	␣	A	B	C	D	E	F	G	H	I	J	K	L	M	N	O	P	Q	R	S	T	U	V	W	X	Y	Z
0	1	2	3	4	5	6	7	8	9	-	␣	R	b	[	d	E	F	G	H	i	J	K	L	M	N	o	P	Q	R	S	T	U	V	W	x	Y	Z

␣ Space

## 11-2 GLP Report

Set the following parameters to output the report.

- To print the report, set the “GLP output ( *INF0* )” parameter to “1”, set the “Data output pause ( *PUSE* )” parameter to “1” and use MODE 3 of the AD-8121B. For details on using the printer, refer to “16-1 Connection to the AD-8121B Printer”.
- To output the report to a personal computer using the RS-232C serial interface, set the “GLP output ( *INF0* )” parameter to “2”.

### Note

If the time and date are not correct, adjust the AD-8121B clock and calendar (HR-A series) or use “[L Adj]” of the function table to adjust the time and date (HR-AZ series).

### Calibration report using an internal weight

When the setting is “*INF0 1*”:

#### AD-8121 format

```

                A & D
MODEL    HR-250AZ
S/N      012345678
ID       ABCDEFG
DATE    2011/12/31
TIME    12:34:56
CALIBRATED (INT.)
REMARKS

SIGNATURE
-----

```

- Space, ASCII 20h
- <TERM> Terminator, C<sub>R</sub>, L<sub>F</sub> or C<sub>R</sub>
- C<sub>R</sub> Carriage return, ASCII 0Dh
- L<sub>F</sub> Line feed, ASCII 0Ah

When the setting is “*INF0 2*”:

#### General data format

```

.....A_&_D<TERM>
MODEL...HR-250AZ<TERM>
S/N....012345678<TERM>
ID.....ABCDEFG<TERM>
DATE<TERM>
.....2011/12/31<TERM>
TIME<TERM>
.....12:34:56<TERM>
CALIBRATED (INT.)<TERM>
REMARKS<TERM>
<TERM>
<TERM>
SIGNATURE<TERM>
<TERM>
<TERM>
-----<TERM>
<TERM>
<TERM>

```

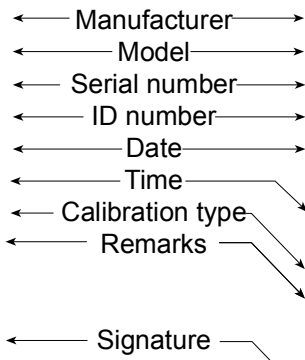

## Calibration report using an external weight

When the setting is “*info 1*”:

AD-8121 format

```

          A & D
MODEL    HR-250AZ
S/N      012345678
ID       ABCDEFG
DATE     2011/12/31
TIME     12:23:34
CALIBRATED(EXT.)
CAL.WEIGHT
          +200.0000 g
REMARKS

SIGNATURE
-----
    
```

⊐ Space, ASCII 20h  
 <TERM> Terminator, C<sub>R</sub>, L<sub>F</sub> or C<sub>R</sub>  
 C<sub>R</sub> Carriage return, ASCII 0Dh  
 L<sub>F</sub> Line feed, ASCII 0Ah

When the setting is “*info 2*”:

General data format

← Manufacturer →	..... A_&_D<TERM>
← Model →	MODEL_...HR-250AZ<TERM>
← Serial number →	S/N_...012345678<TERM>
← ID number →	ID_...ABCDEFG<TERM>
← Date →	DATE<TERM>
← Time →	<TERM>
← Calibration type →	TIME<TERM>
← Calibration weight →	<TERM>
← Remarks →	CALIBRATED(EXT.)<TERM>
	CAL.WEIGHT<TERM>
	...±200.0000...g<TERM>
	REMARKS<TERM>
	<TERM>
	<TERM>
← Signature →	SIGNATURE<TERM>
	<TERM>
	<TERM>
	-----<TERM>
	<TERM>
	<TERM>

\* With HR-AZ series, the time and date are added to output data.

## Calibration test report using an external weight

(Calibration test does not perform calibration.)

When the setting is “*info 1*”:

AD-8121 format

```

          A & D
MODEL    HR-250AZ
S/N      012345678
ID       ABCDEFG
DATE     2011/12/31
TIME     12:23:34
CAL.TEST(EXT.)
ACTUAL
          0.0000 g
          +199.9999 g
TARGET
          +200.0000 g
REMARKS

SIGNATURE
-----
    
```

⊐ Space, ASCII 20h  
 <TERM> Terminator, C<sub>R</sub>, L<sub>F</sub> or C<sub>R</sub>  
 C<sub>R</sub> Carriage return, ASCII 0Dh  
 L<sub>F</sub> Line feed, ASCII 0Ah

When the setting is “*info 2*”:

General data format

← Manufacturer →	..... A_&_D<TERM>
← Model →	MODEL_...HR-250AZ<TERM>
← Serial number →	S/N_...012345678<TERM>
← ID number →	ID_...ABCDEFG<TERM>
← Date →	DATE<TERM>
← Time →	<TERM>
← Calibration test type →	TIME<TERM>
← Zero point value →	<TERM>
← Target weight value →	CAL. TEST (EXT.)<TERM>
← Target weight →	ACTUAL<TERM>
← Remarks →	.....0.0000...g<TERM>
	...+199.9999...g<TERM>
	TARGET<TERM>
	...+200.0000...g<TERM>
	REMARKS<TERM>
	<TERM>
	<TERM>
← Signature →	SIGNATURE<TERM>
	<TERM>
	<TERM>
	-----<TERM>
	<TERM>
	<TERM>

\* With HR-AZ series, the time and date are added to output data.

## Title block and end block

When a weight value is recorded as the GLP data, “Title block” and “End block” are inserted at the beginning and at the end of a group of weight values, in the GLP report.

### Note

To output the report to an AD-8121B , use **MODE 3** of the AD-8121B.

### Operation

- 1 With the weight data displayed, press and hold the **PRINT** key until **Start** is displayed. The “Title block” is output.
- 2 The weight data is output according to the parameter setting of the data output mode.
- 3 Press and hold the **PRINT** key until **End** is displayed. The “End block” is output.

When the setting is “Info 1”:

#### AD-8121 format

```

      A & D
MODEL  HR-250AZ
S/N    012345678
ID     ABCDEFG
DATE   2011/12/31
START  12:23:34
TIME

WT     +12.3456 g
WT     +12.3461 g
WT     +12.3462 g
WT
  
```

```

WT     +12.3451 g
WT     +12.3453 g
WT     +12.3471 g
WT     +12.3464 g
  
```

```

END
TIME   12:34:56
REMARKS
  
```

```

SIGNATURE
-----
  
```

When the setting is “Info 2”:

#### General data format

```

_____ A_&_D<TERM>
MODEL___HR-250AZ<TERM>
S/N____012345678<TERM>
ID_____ABCDEFG<TERM>
DATE<TERM>
<TERM>
START<TERM>
TIME<TERM>
<TERM>
  
```

```

WT___+12.3456___g<TERM>
WT___+12.3461___g<TERM>
  
```

```

WT___+12.3451___g<TERM>
WT___+12.3453___g<TERM>
WT___+12.3471___g<TERM>
WT___+12.3464___g<TERM>
  
```

```

<TERM>
END<TERM>
TIME<TERM>
<TERM>
  
```

```

REMARKS<TERM>
<TERM>
<TERM>
  
```

```

SIGNATURE<TERM>
<TERM>
<TERM>
  
```

```

-----<TERM>
<TERM>
<TERM>
  
```

- Space, ASCII 20h
- <TERM> Terminator, C<sub>R</sub>, L<sub>F</sub> or C<sub>R</sub>
- C<sub>R</sub> Carriage return, ASCII 0Dh
- L<sub>F</sub> Line feed, ASCII 0Ah

\* With HR-AZ series, the time and date are added to output data.

## 12. UNDERHOOK

The underhook can be used for magnetic materials or density measurement. The built-in underhook is revealed by removing the plastic cap on the bottom of the balance.

Use the underhook as shown below.

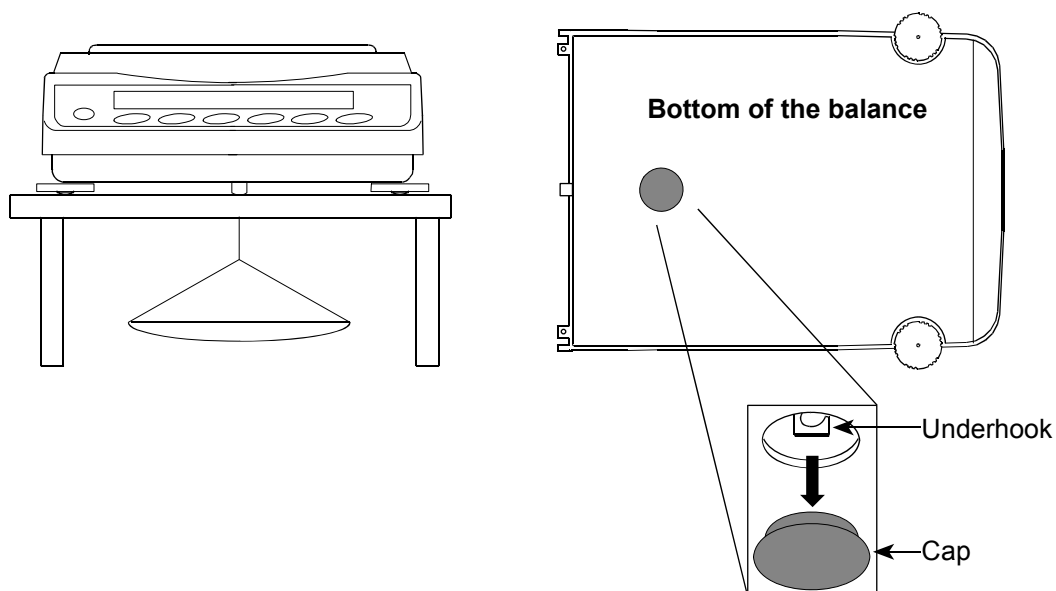

### Caution

**Do not apply excessive force to the underhook.**

**When not in use, attach the plastic cap to prevent dust from getting into the balance.**

**Do not push the underhook upward.**

## 13. Density Measurement (Specific gravity)

The balance is equipped with a density mode. It calculates the density of a solid using the mass value of a sample in air and the mass value in liquid. We recommend the use of the AD-1654 Density Determination Kit.

### Note

- The density mode was not selected for use when the balance was shipped from the factory. To use this mode, change the function table settings to activate the density mode. Refer to "5.2. Storing Active Units".
- The minimum display is 0.0001 g while using the density mode.

### Formula to obtain the density

#### Density of a solid

The density of a solid can be obtained by the mass value of each sample in air, liquid and the liquid density.

$$\rho = \frac{A}{A - B} \times \rho_0$$

Where

- $\rho$  : Density of a sample
- A : Mass value of a sample in air
- B : Mass value of a sample in liquid
- $\rho_0$  : Density of a liquid

#### Density of a liquid

By using a float with a known volume, the density of a liquid can be obtained by the mass value of the float in air and liquid, using the volume of the float.

$$\rho = \frac{A - B}{V}$$

Where

- $\rho$  : Density of a sample
- A : Mass value of the float in air
- B : Mass value of the float in liquid
- V : Volume of the float

### Prior to measurement: Changing the function table

Prior to measurement, change the function table as follows:

- 1 Selecting the density mode.  
The density mode is available as one of the weighing units. Select it by pressing the **MODE** key. To use the mode, select it (unit of **Unit IS**.) in the function table. Refer to "5.2. Storing Active Units".
- 2 Selection of the sample for measurement.  
Select whether the measurement sample is a solid or liquid.
- 3 Selecting a way to set the density of a liquid.  
Select the liquid density input method from the function table below.

### Note

The following function table is displayed only when the unit of **Unit IS** is active. The table of the density mode (**d5 Fnc**) is displayed next **5 iF**.

Class	Item and Parameter	Description
d5 Fnc Density function	L d in Liquid density input	▪ <input type="checkbox"/> Water temperature
		! Liquid density
	d5 Selection of a measurement sample	▪ <input type="checkbox"/> Density measurement of a solid
		! Density measurement of a liquid

▪ is factory setting.



## Measuring the density of a solid ( specific gravity )

**Note** If the liquid temperature or the type of liquid is changed during measurement, again input the value of the liquid density as necessary. The density display is four decimal places. The minimum display can not be changed with the **SAMPLE** key.

The density (or specific gravity) is displayed after "Mass measurement in air" and "Mass measurement in liquid".

The procedure of each measurements is as follows:

g : gram. ◀ : the processing indicator.

- 1 Enter the density mode. (g lights. ◀ blinks.)  
Place nothing on both pan and press the **RE-ZERO** key to display zero.
- 2 Place the sample on the pan in air. (g lights. ◀ blinks.)  
If the weight value is output, press the **PRINT** key to store it after a stable weight value is displayed.  
Press the **SAMPLE** key to decide the weight value in air and proceed to next step.  
**Note** If negative value or **ε** (out of range) is displayed, the **SAMPLE** key is inactive.
- 3 Move the sample to the pan in liquid. (g lights. ◀ lights.)  
If the weight value is output, press the **PRINT** key to store it after a stable weight value is displayed.  
Press the **SAMPLE** key to decide the weight value in liquid and proceed to next step.  
**Note** If **ε** (out of range) is displayed, the **RANGE** key is inactive.
- 4 Inputting the density of the liquid  
Refer to "Entering the density of a liquid" and set the density of the liquid. Press the **SAMPLE** key to proceed to the next step.
- 5 If the density value is stored or output, press the **PRINT** key to store it. (Unit :  $\bar{5}$ . g turns off. ◀ lights.)  
Press the **SAMPLE** key to measure another sample and proceed to step 2.
- 6 If the liquid temperature or the type of liquid is changed during measurement, input again the value of the liquid density as necessary.
- 7 Press the **MODE** key to proceed to other modes.

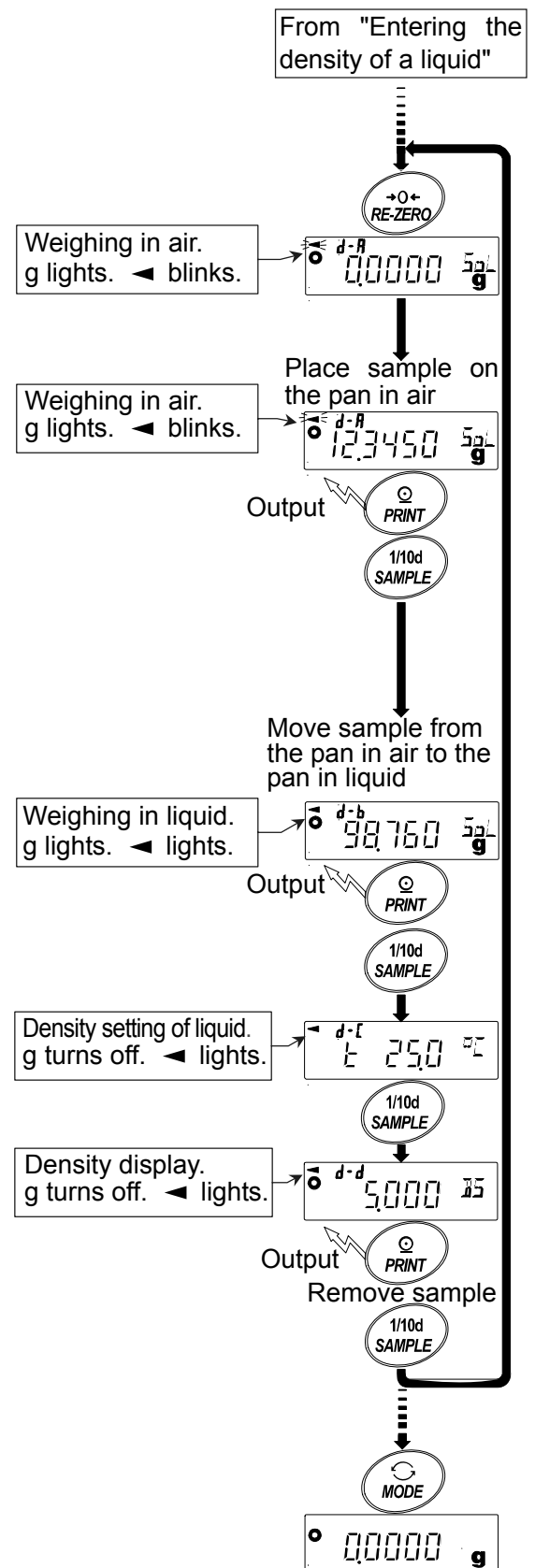

## Entering the density of a liquid

Two ways to set the density of a liquid are available in the function table, "Liquid density input ( $Ld_{in}$ ): by entering the water temperature or by entering the density directly.

### Entering the water temperature ( $Ld_{in} 0$ )

The water temperature currently set (unit: °C, factory setting : 25.0°C) is displayed. Use the following keys to change the value.

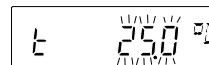

**RE-ZERO** (+)key..... The key to increase the temperature.  
(0.0°C is displayed after 99.9°C)

**MODE** (-)key ..... The key to decrease the temperature.  
(99.9°C is displayed after 0.0°C)

**PRINT** key ..... The key to select the digit to change the value.

**SAMPLE** key ..... The key to store new water temperature, display **End** and return to the density displaying mode. Proceed to Step 5.

**CAL** key ..... The key to cancel the change and return to the density displaying mode.  
Proceed to Step 5.

## The relation between the water temperature and density

°C	+0	+1	+2	+3	+4	+5	+6	+7	+8	+9
0	0.99984	0.99990	0.99994	0.99996	0.99997	0.99996	0.99994	0.99990	0.99985	0.99978
10	0.99970	0.99961	0.99949	0.99938	0.99924	0.99910	0.99894	0.99877	0.99860	0.99841
20	0.99820	0.99799	0.99777	0.99754	0.99730	0.99704	0.99678	0.99651	0.99623	0.99594
30	0.99565	0.99534	0.99503	0.99470	0.99437	0.99403	0.99368	0.99333	0.99297	0.99259
40	0.99222	0.99183	0.99144	0.99104	0.99063	0.99021	0.98979	0.98936	0.98893	0.98849
50	0.98804	0.98758	0.98712	0.98665	0.98618	0.98570	0.98521	0.98471	0.98422	0.98371
60	0.98320	0.98268	0.98216	0.98163	0.98110	0.98055	0.98001	0.97946	0.97890	0.97834
70	0.97777	0.97720	0.97662	0.97603	0.97544	0.97485	0.97425	0.97364	0.97303	0.97242
80	0.97180	0.97117	0.97054	0.96991	0.96927	0.96862	0.96797	0.96731	0.96665	0.96600
90	0.96532	0.96465	0.96397	0.96328	0.96259	0.96190	0.96120	0.96050	0.95979	0.95906

g/cm<sup>3</sup>

### Entering the density directly ( $Ld_{in} 1$ )

The density currently set (unit : g / cm<sup>3</sup>, factory setting : 1.0000g / cm<sup>3</sup>) is displayed. Use the following keys to change the value.



The range to set the density is 0.0000g / cm<sup>3</sup> to 1.9999g / cm<sup>3</sup>.

**RE-ZERO** (+)key.. The key to increase the value of the digit selected.

**MODE** (-)key ..... The key to decrease the value of the digit selected.

**PRINT** key ..... The key to select the digit to change the value.

**SAMPLE** key ..... The key to store the change, display **End** and return to the density displaying mode. Proceed to Step 5.

**CAL** key ..... The key to cancel the change and return to the density displaying mode. Proceed to Step 5.

## Measuring the density of a liquid ( specific gravity )

**Note** The density display is four decimal places. The minimum display can not be changed with the **SAMPLE** key.

The density (or specific gravity) is displayed after "Mass measurement of a float in air" and "Mass measurement a float in liquid". The procedure of each measurements is as follows:

g : gram. ◀ : the processing indicator.

- 1 Enter the density mode. (g lights. ◀ blinks.)  
Place nothing on the weighing pan and press the **RE-ZERO** key to display zero.
- 2 Place the float on the weighing pan. (g lights. ◀ blinks.)  
If the weight value of the float is output, press the **PRINT** key to store it after a stable weight value is displayed.  
Press the **SAMPLE** key to decide the weight value in air and proceed to next step.  
**Note** If negative value or **E** (out of range) is displayed, the **SAMPLE** key is inactive.
- 3 Pour in the liquid for the density measurement and submerge the float in the liquid. At this time, confirm that the float is approx. 10 mm under the liquid surface. Wait until the display is in the stable state to take a reading.  
If the weight value is output, press the **PRINT** key.  
Press the **SAMPLE** key to decide the weight value in liquid and proceed to next step.  
**Note** If **E** (out of range) is displayed, the **SAMPLE** key is inactive.
- 4 Inputting the volume of the float  
Refer to "Entering the volume of a float" and Input the volume of a float. Press the **SAMPLE** key to proceed to the next step.
- 5 If the density value is output, press the **PRINT** key to store it. (Unit : 1/5. g turns off. ◀ lights.)  
Press the **SAMPLE** key to measure another sample and proceed to step 2.
- 6 Press the **MODE** key to proceed to other modes.

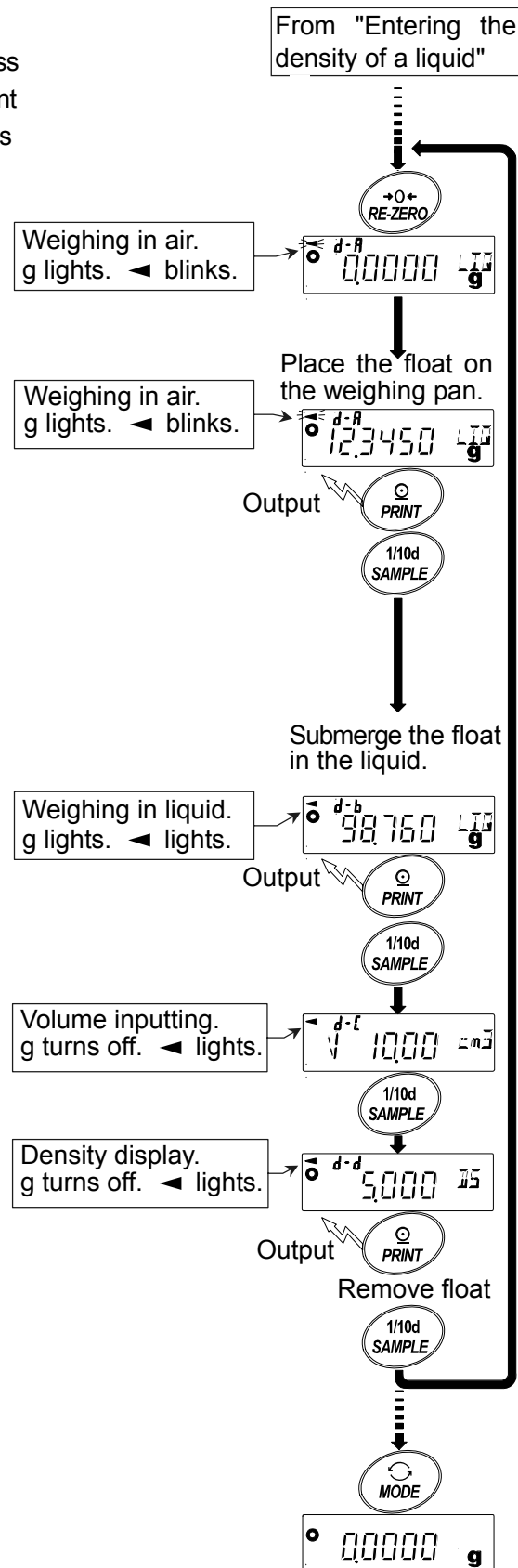

## Entering the volume of a float

The balance displays the set float volume (factory setting: 10.00cm<sup>3</sup>). Change the setting value by using the following keys if necessary.

Available adjustment range is 0.01 to 99.99 cm<sup>3</sup>, and unit is 0.01 cm<sup>3</sup>.

**RE-ZERO** (+)key·· The key to increase the value of the digit selected.

**MODE** (-)key······ The key to decrease the value of the digit selected.

**PRINT** key········ The key to select the digit to change the value.

**SAMPLE** key······ The key to store the change, display **End** and return to the density displaying mode. Proceed to Step 5.

**CAL** key·········· The key to cancel the change and return to the density displaying mode. Proceed to Step 5.

# 14. PROGRAMMABLE-UNIT

This is a programmable unit conversion function. It multiplies the weight data in grams by an arbitrary coefficient set in the function table and displays the result.

The coefficient must be within the range between the minimum and maximum shown below. If the coefficient set is beyond the range, an error is displayed and the balance returns to the coefficient setting mode, prompting to enter an appropriate value. A coefficient of 1 was set at the factory.

Model	Minimum coefficient	Maximum coefficient
HR-100AZ / 150AZ / 250AZ HR-100A / 150A / 250A	0.000001	10000

## Operation

- 1 Press and hold the **SAMPLE** key until **bRSFnC** of the function table is displayed.
- 2 Press the **SAMPLE** key several times to display **MLT**.
- 3 Press the **PRINT** key. The balance enters the mode to confirm or set the coefficient.

## Confirming the coefficient

- 4 The current coefficient is displayed with the first digit blinking.
  - When it is not to be changed, press the **CAL** key and go to step 6.
  - When it is to be changed, press the **RE-ZERO** key and go to step 5.

## Setting the coefficient

- 5 Set the coefficient using the following keys.

**SAMPLE** key To select a digit to change the value. The selected digit blinks.

**RE-ZERO** key To change the value.

**MODE** key To change the decimal point position.

Each time the switch is pressed, the decimal point position changes as follows:

→ 0.000001 → 00.00001 → ... → 000000.1 → 0000001 →

**PRINT** key To store the new setting, display **End** and go to step 6.

**CAL** key To cancel the new setting and go to step 6.

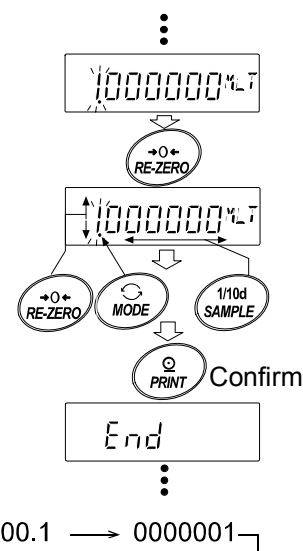

## Quitting the operation

- 6 The balance displays **Unit**. Press the **CAL** key to exit the programmable-unit function and return to the weighing mode.

## Using the function

Press the **MODE** key to select the programmable-unit (no display on the unit section). Perform weighing as described in "6-1 Basic Operation (Gram Mode)". After weighing, the balance displays the result (weight data in grams x coefficient).

# 15. RS-232C SERIAL INTERFACE

The balance is a Data Communication Equipment (DCE) device. Connect the balance to a personal computer (DTE) using a straight through cable.

- Transmission system: EIA RS-232C (D-Sub 9-pin, female connector)
- Transmission form : Asynchronous, bi-directional, half duplex
- Transmission rate : 10 times/second or 5 times/second (same as data refresh rate)
- Data format : Baud rate : 600, 1200, 2400, 4800, 9600, 19200 bps
- Data bits : 7 or 8 bits
- Parity : Even, Odd (Data bits 7 bits)
- None (Data bits 8 bits)
- Stop bit : 1 bit
- Code : ASCII

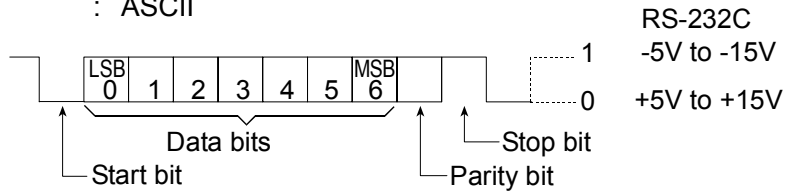

## D-Sub 9-pin assignments

Pin No.	Signal name	Direction	Description
1	-	-	No connection
2	TXD	Output	Transmit data
3	RXD	Input	Receive data
4	-	-	No connection
5	SG	-	Signal ground
6	DSR	Output	Data set ready
7	RTS	Input	Request to send
8	CTS	Output	Clear to send
9	-	-	No connection

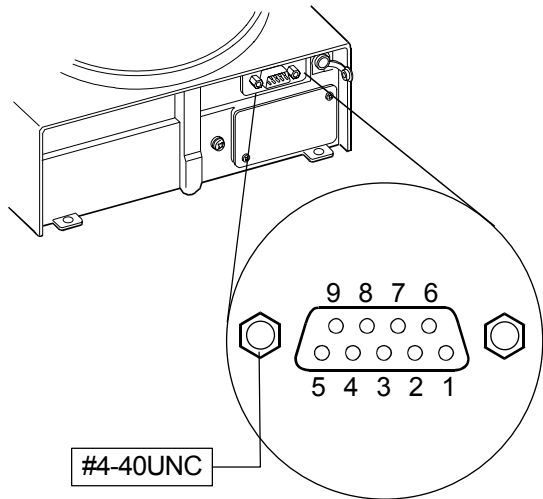

Signal names of the balance side are the same as the DTE side with TXD and RXD reversed.

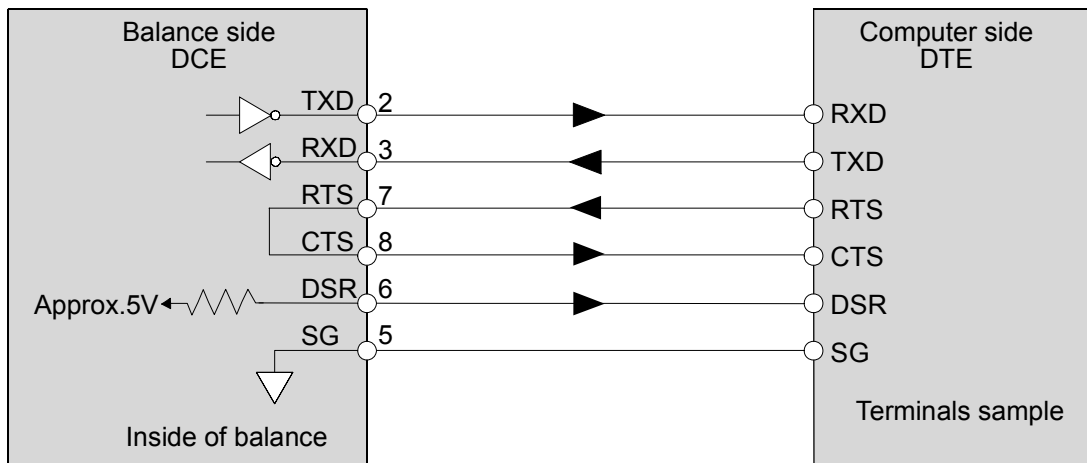

# 16. CONNECTION TO PERIPHERAL EQUIPMENT

## 16-1 Connection to the AD-8121B Printer

Set the following parameters to use the AD-8121B printer.

Example of use	AD-8121B mode setting
To print A&D standard format weight data, using the HR-AZ / HR-Z <b>PRINT</b> key or auto print mode. (The time and date can be added.)	MODE 1
To print A&D standard format weight data, using the AD-8121B <b>DATA</b> key or AD-8121B built-in timer. (The time and date can be added.) To print, using the AD-8121B chart printing function.	MODE 2
To print the HR-AZ / HR-Z statistical data.	MODE 3
To print GLP output.	MODE 3

Class	Item and Parameter	Factory settings	AD-8121B MODE 1	AD-8121B MODE 2	AD-8121B MODE 3
<i>dout</i> Data output	<i>Prt</i> Data output mode	0	0, 1, 2, 4, 5 *1	3	0, 1, 2, 4, 5 *1
	<i>PUSE</i> Data output pause	0	0	0	0, 1 *2
<i>SIF</i> Serial interface	<i>bPS</i> Baud rate	2	2	2	2
	<i>btPr</i> Data bit, parity bit	0	0	0	0
	<i>CrLF</i> Terminator	0	0	0	0
	<i>tYPE</i> Data format	0	0	0	1

\*1 Set appropriate parameters for "AP-P (Auto print polarity)" and "AP-b (Auto print difference)" when auto print mode A or B (*Prt* 1 or 2) is selected.

Set the AD-8121B DIP switch No.3 to ON when unstable data is printed with "*Prt* 4".

\*2 Set 1 when multiple lines are printed in the HR-AZ / HR-Z statistical calculation mode.

### Notes

Refer to "11-2 GLP Report" for print samples.

### Settings of AD-8121B DIP switches

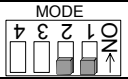
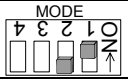
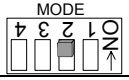
MODE	AD-8121B DIP switch	Description
MODE 1		Print at receiving data. Standard mode, statistical calculation mode
MODE 2		Print by the AD-8121B <b>DATA</b> key operation or AD-8121B built-in timer. Standard mode, interval mode, chart mode
MODE 3		Print at receiving data. Dump print mode

DIP switch No.3 : Handling unstable data

ON Print  
OFF Not printed

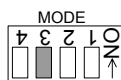

Set the DIP switch No.4 to OFF.

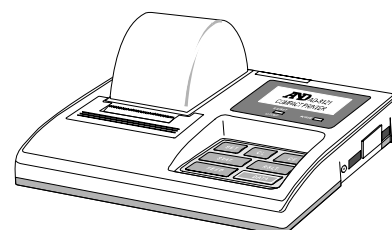
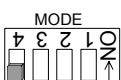

## 16-2 Connection to a Computer

---

The balance can be connected to a personal computer using the RS-232C serial interface. As an option, the HRA-02 USB interface is available to transmit the balance data to a personal computer.

The balance is a DCE device. Use a straight through cable when connecting to a personal computer. A commercially available modem cable can be used. When purchasing, confirm the following specifications.

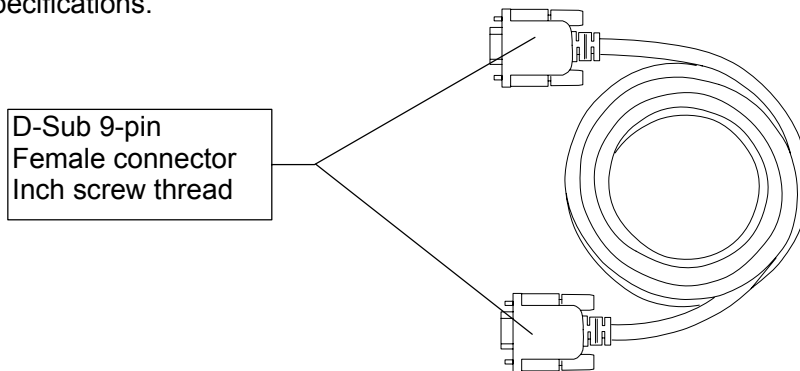

## 16-3 Using Windows Communication Tools (WinCT)

---

When Windows is used as an operating system in a personal computer, the WinCT software, that is downloaded from the A&D website, can be used to transmit the weight data to the personal computer.

The WinCT has three communication methods: "RsCom", "RsKey" and "RsWeight".

### RsCom

- Can transmit commands to control the balance.
- Can make bi-directional communication between the balance and a personal computer using the RS-232C serial interface.
- Can display or store the data using a text file format. Can also print the data using a printer connected to a personal computer.
- When several ports of a personal computer have balances connected, can communicate with each balance simultaneously.
- Can share a personal computer with other application software.

### RsKey

- Can transmit the weight data output from the balance directly to other application software such as Microsoft Excel.
- Can be used with most application software.

### RsWeight

- Can retrieve the weight data from the balance and display the data as a graph in real time.
- Can calculate and display the maximum, minimum, average, standard deviation and coefficient of variation.



**Using the WinCT software, the balance can do the following:**

- 1 Analyzing the weight data and the statistics with “RsKey”  
The weight data can be input directly into an Excel worksheet. Then, Excel can analyze the data to obtain sum, average, standard deviation, maximum and minimum value, and display them as a graph.
- 2 Controlling the balance using commands from a personal computer  
By using “RsCom”, the personal computer sends commands such as “re-zero” or “send weight data” to the balance and controls the balance.
- 3 Printing the balance GLP report using your printer  
The balance GLP report can be printed using a printer connected to a personal computer.
- 4 Receiving weight data at a certain interval  
The weight data can be received at a certain interval and data characteristic with elapsed time can be obtained.
- 5 Using a personal computer as an external indicator  
With the “RsKey” test mode function, a personal computer can be used as an external weight indicator for the balance. (To do this, set the balance data output mode to stream mode.)

# 17. COMMANDS

## 17-1 Command List

### Note

A command has a terminator added, that is specified using the "Terminator (E<sub>RLF</sub>)" parameter of "Serial interface (S<sub>IF</sub>)" in the function table, and is sent to the balance.

### Commands to query weight data

<b>C</b>	Cancels the <b>S</b> or <b>SIR</b> command.
<b>Q</b>	Requests the weight data immediately.
<b>S</b>	Requests the weight data when stabilized.
<b>SI</b>	Requests the weight data immediately.
<b>SIR</b>	Requests the weight data continuously.
<b>E<sub>sc</sub>P</b>	Requests the weight data when stabilized.

Note: The "Q" and "SI" commands, the "S" and "E<sub>sc</sub>P" commands behave the same.

### Commands to control the balance

<b>CAL</b>	Same as the <b>CAL</b> key.
<b>EXC *</b>	Calibration using an external weight
<b>OFF</b>	Turns the display off.
<b>ON</b>	Turns the display on.
<b>P</b>	Same as the <b>ON:OFF</b> key
<b>PRT</b>	Same as the <b>PRINT</b> key
<b>R</b>	Same as the <b>RE-ZERO</b> key
<b>SMP</b>	Same as the <b>SAMPLE</b> key.
<b>T</b>	Tare key
<b>Z</b>	Same as the <b>RE-ZERO</b> key
<b>E<sub>sc</sub>T</b>	Same as the <b>RE-ZERO</b> key
<b>U</b>	Same as the <b>MODE</b> key
<b>?ID</b>	Requests the ID number.
<b>?SN</b>	Requests the serial number.
<b>?TN</b>	Requests the model name.
<b>?PT</b>	Requests the tare weight.
<b>PT: *****. *<sub>uu</sub>g</b>	Changes the tare weight. The unit added is the current weighing unit in A&D standard format.

Note: The "R", "Z" and "E<sub>sc</sub>T" commands behave the same.

E<sub>sc</sub> : ASCII code 1Bh

\* : Only for the HR-AZ series

## 17-2 Acknowledge Code and Error Codes

When the “AK, Error code (ErCd)” parameter of “Serial interface (SIF)” is set to “1”, the balance outputs <AK> code or an error code for each command as follows:

<AK> (06h) Acknowledge in ASCII code.

- When the balance receives a command to request data and can not process it, the balance transmits an error code (EC, Exx).  
When the balance receives a command to request data and can process it, the balance outputs the data.
- When the balance receives a command to control the balance and can not process it, the balance transmits an error code (EC, Exx).  
When the balance receives a command to control the balance and can process it, the balance transmits the acknowledge code.

Among commands to control the balance, the following transmit the acknowledge code both when the balance receives the command and when the balance has accomplished the command. If the command can not be processed properly, the balance transmits an error code (EC, Exx). This error can be released using the CAL command.

CAL command (When performing the calibration using a calibration weight)

ON command, P command

R command, Z command, T command (When setting the display to zero)

R command example

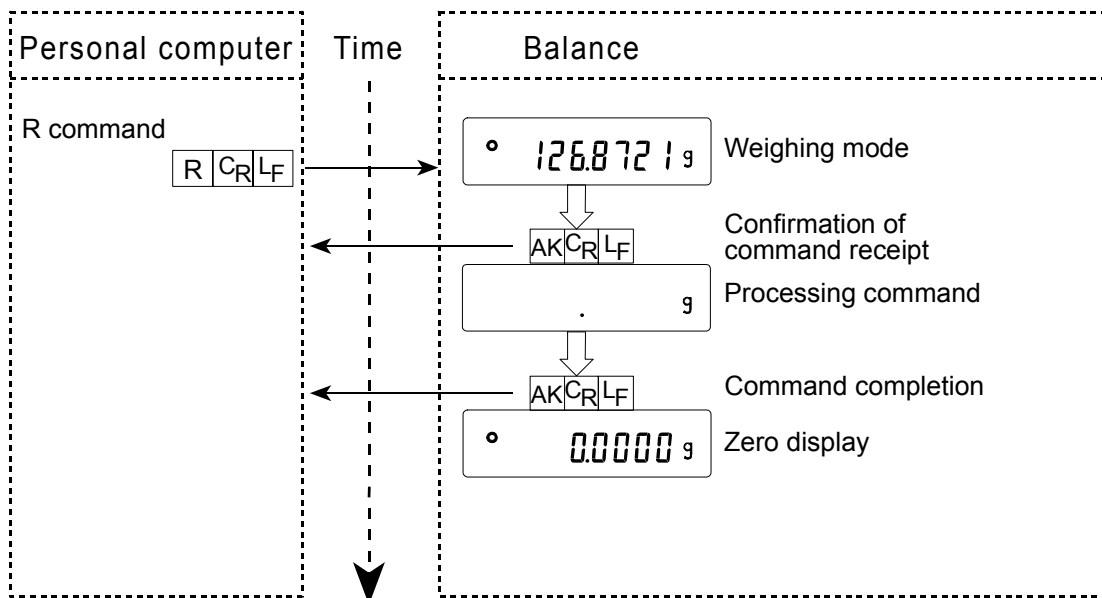

CAL command example (HR-AZ series: Calibration using the internal mass)

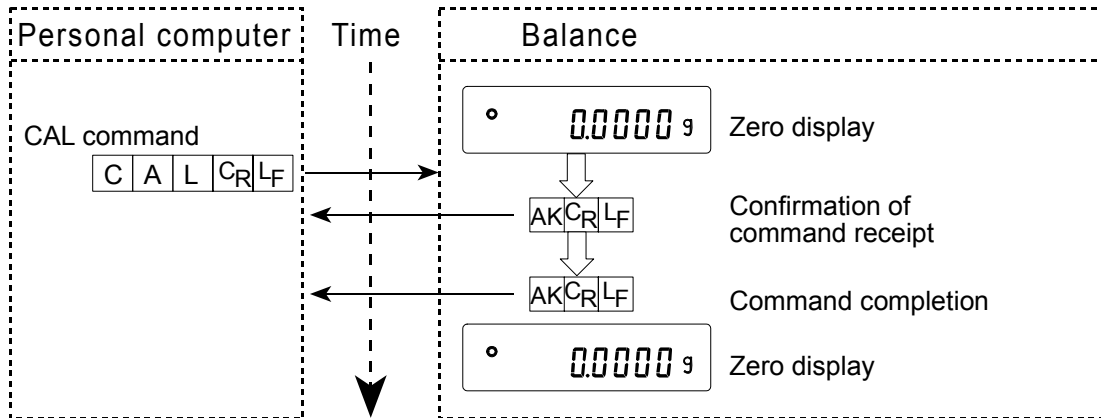

CAL command example (HR-A series: Calibration using an external weight)

\* : EXC command for HR-AZ series

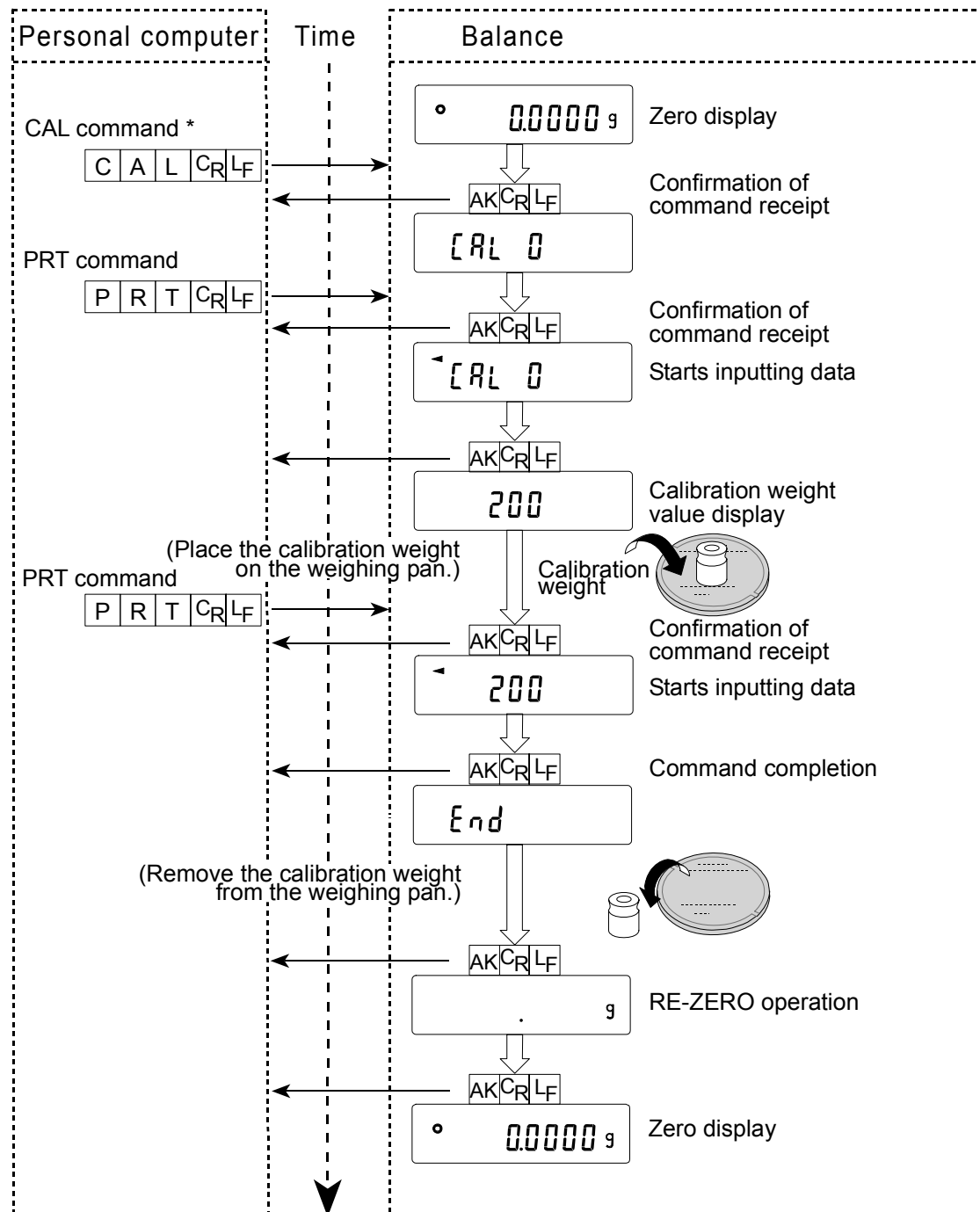

### T command example

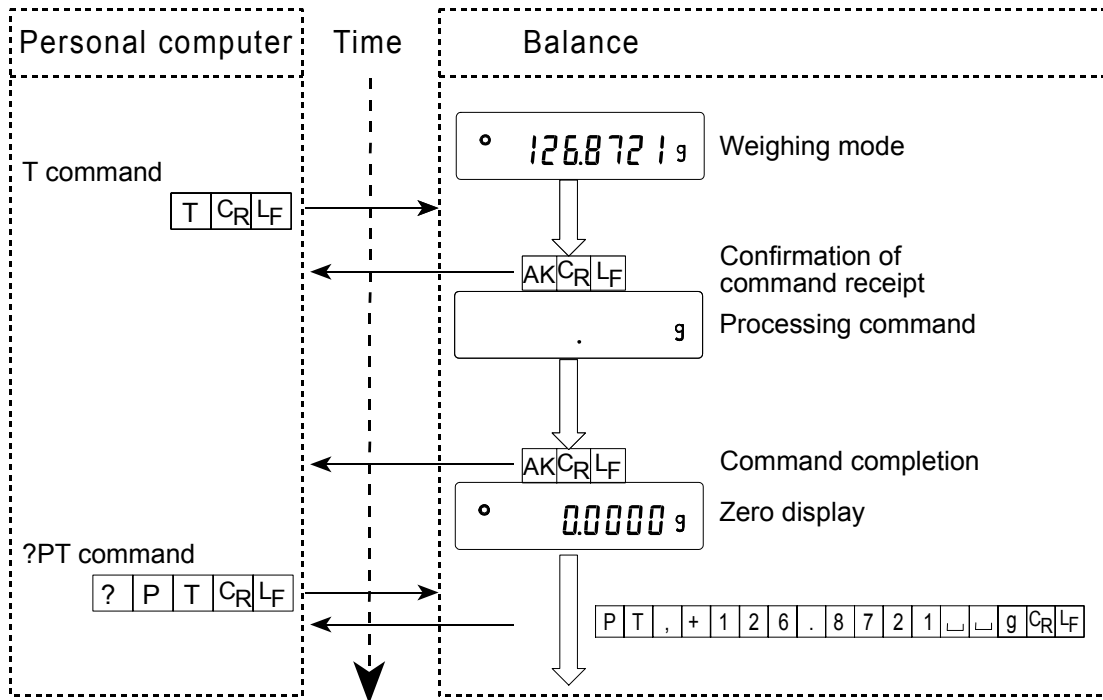

### PT command example

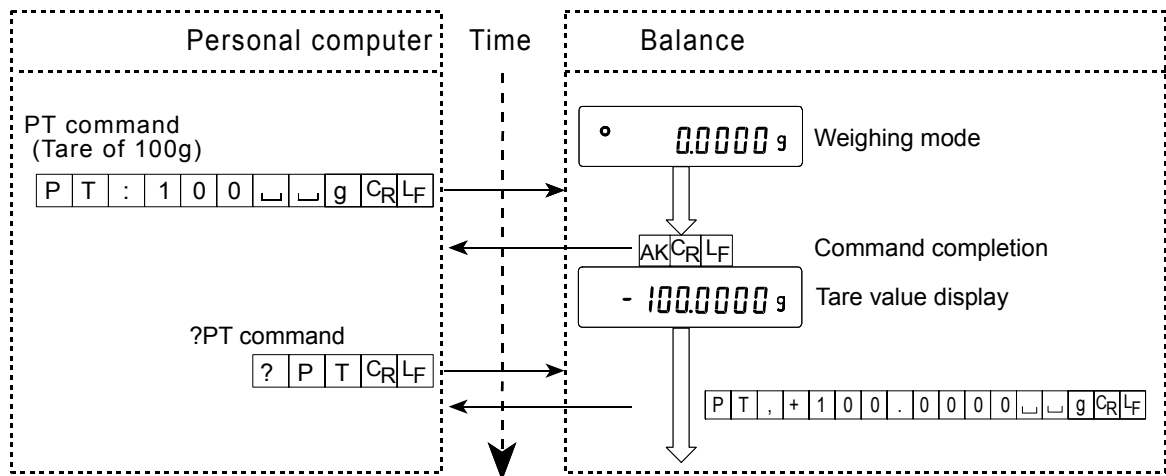

- When a communication error has occurred due to external noise, or a parity error has occurred due to transmission error, the balance transmits an error code. In this case, send the command again.

## 17-3 Settings Related to RS-232C

Concerning the RS-232C, the balance has two functions: “Data output ( *dout* )” and “Serial interface ( *SIF* )”. Set each function as necessary.

## 18. MAINTENANCE

- Do not use organic solvents to clean the balance. Clean the balance with a lint free cloth that is moistened with warm water and a mild detergent.
- Do not disassemble the balance. Contact the local A&D dealer if the balance needs service or repair.
- Use the original packing material for transportation.

## 19. TROUBLESHOOTING

### 19-1 Checking the Balance Performance and Environment

The balance is a precision instrument. When the operating environment or the operating method is inadequate, correct weighing can not be performed. Place a sample on the pan and remove it, and repeat this several times. If the balance seems to have a problem with repeatability or to perform improperly, check as described below. Also, visit our website, <http://www.aadd.co.jp/>, for "Information Library" and "FAQ". If improper performance persists after checking, contact the local A&D dealer for repair.

#### Checking that the balance performs properly

- Check the balance repeatability using an external weight. Be sure to place the weight in the center of the weighing pan.
- Check the balance repeatability, linearity and calibrated value using external weights with a known value.

#### Checking that the operating environment or weighing method is proper

##### Operating environment

- Is the weighing table solid enough?
- Is the balance level? Refer to "3-1 Before Use".
- Is the operating environment free from vibration and drafts? Has the breeze break been installed?
- Is there a strong electrical or magnetic noise source such as a motor near the balance?



##### Weighing method

- Is the weighing pan installed correctly?
- Is the **RE-ZERO** key pressed before placing a sample on the weighing pan?
- Is the sample placed in the center of the weighing pan?
- Has the balance been calibrated using an external weight? (Or one-touch calibration, only for the HR-AZ series)
- Has the balance been warmed up for 30 minutes before weighing?

##### Sample and container

- Has the sample absorbed or lost moisture due to the ambient conditions such as temperature and humidity?
- Has the temperature of the container been allowed to equalize to the ambient temperature? Refer to "3-2 During Use".
- Is the sample charged with static electricity? Refer to "3-2 During Use".  
The HR-AZ/HR-A series balances are prone to be charged with static electricity when the relative humidity is low.
- Is the sample of magnetic material such as iron? Caution is required for weighing magnetic materials. Refer to "3-2 During Use".

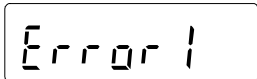
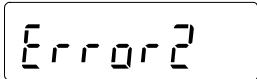
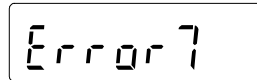
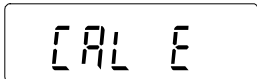
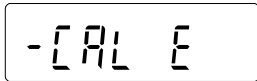
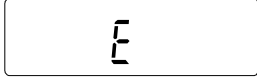
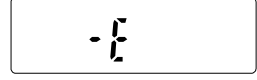
## 19-2 Error Codes

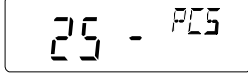
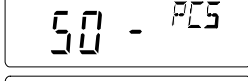
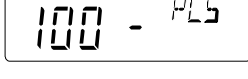
Display	Error code	Description
	<b>EC, E11</b>	<p><b>Stability error</b></p> <p>The balance can not stabilize due to an environmental problem. Prevent vibration, drafts, temperature changes, static electricity and magnetic fields.</p> <p>Refer to “3. PRECAUTIONS” for details on the operating environment and “7. RESPONSE ADJUSTMENT” about adapting the balance to the environment.</p> <p>To return to the weighing mode, press the <b>CAL</b> key.</p>
		<p><b>Out of range error</b></p> <p>The value entered is beyond the settable range.</p> <p>Re-enter the value.</p>
	<b>EC, E17</b>	<p><b>Internal mass error (Only for the HR-AZ series)</b></p> <p>The internal mass application mechanism does not function properly. Perform the weighing operation from the beginning again.</p>
	<b>EC, E20</b>	<p><b>Calibration weight error</b></p> <p>The calibration weight is too heavy.</p> <p>Confirm that the weighing pan is properly installed. Confirm the calibration weight value.</p> <p>Press the <b>CAL</b> key to return to the weighing mode.</p>
	<b>EC, E21</b>	<p><b>Calibration weight error</b></p> <p>The calibration weight is too light.</p> <p>Confirm that the weighing pan is properly installed. Confirm the calibration weight value.</p> <p>Press the <b>CAL</b> key to return to the weighing mode.</p>
		<p><b>Overload error</b></p> <p>A sample beyond the balance weighing capacity has been placed on the pan.</p> <p>Remove the sample from the pan.</p>
		<p><b>Weighing pan Error</b></p> <p>The weight value is too light.</p> <p>Confirm that the weighing pan is properly installed and calibrate the balance.</p>
		<p><b>Sample mass error</b></p> <p>The balance can not store the sample for the counting mode or for the percent mode because it is too light.</p> <p>Use a sample that is heavier.</p>
  		<p><b>Unit mass error</b></p> <p>The sample unit mass for the counting mode is too light. Storing and using it for counting will cause a counting error.</p> <p>Add samples to reach the specified number and press the <b>PRINT</b> key.</p> <p>Pressing the <b>PRINT</b> key without adding samples will shift the balance to the counting mode. But, to acquire accurate weighing, be sure to add samples.</p>

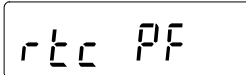
Display	Error code	Description
		<b>Balance internal error</b> If this error appears persistently, contact the local A&D dealer.
		<b>Battery error for clock</b> The back-up battery power for the clock was lost completely. After pressing one of the keys, adjust the date and time. Even if the back-up battery power for the clock was lost and the balance is on or in the standby state, the balance performance will be normal. When this error appears frequently, repair is required.
	<b>EC, E00</b>	<b>Communications error</b> A protocol error occurred in communications. Confirm the format, baud rate and parity.
	<b>EC, E01</b>	<b>Undefined command error</b> An undefined command was received. Confirm the command.
	<b>EC, E02</b>	<b>Not ready</b> A received command can not be processed. e.g. The balance received a Q command, but not in the weighing mode. e.g. The balance received a Q command while processing a RE-ZERO command. Adjust the delay time to transmit a command.
	<b>EC, E03</b>	<b>Timeout error</b> If the timeout parameter is set to "t-UP 1", the balance did not receive the next character of a command within the time limit of one second. Confirm the communication.
	<b>EC, E04</b>	<b>Excess characters error</b> The balance received excessive characters in a command. Confirm the command.
	<b>EC, E06</b>	<b>Format error</b> A command includes incorrect data. e.g. The data is numerically incorrect. Confirm the command.
	<b>EC, E07</b>	<b>Parameter setting error</b> The received data exceeds the range that the balance can accept. Confirm the parameter range of the command.
<b>Other errors</b>		If the errors described above can not be released or other errors are displayed, contact the local A&D dealer.

## 19-3 Asking For Repair

If the balance needs service or repair, contact the local A&D dealer.

The balance is a precision instrument. Use much care when handling the balance and observe the following when transporting the balance.

- Use the original packing material.
- Remove the weighing pan from the main unit



# 20. OPTIONS

## Note

The HRA-02, HRA-08 and HRA-09 can not be used at the same time.

### HRA-02 USB interface

(Installed in the balance, Applicable OS: Windows 98 OSR2 or later)

- Used to transmit the balance weight data (numerical value only) uni-directionally to a personal computer via USB.
- Can transmit the balance weight data (numerical value only) directly to application software such as Microsoft Excel, Word and memo pad.
- Driver installation is not necessary.

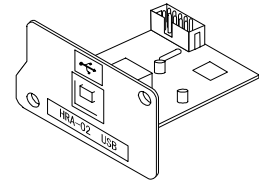

HRA-02 Example of use

	A	B	C	D	E	F	G
1	2019.24						
2	2019.26						
3	2019.28						
4	2232.58						
5	2019.27						
6	2019.27						
7	2019.26						
8	1863.45						
9							
10							
11							
12							
13							
14							
15							

## Note

To perform bi-directional communication using WinCT or input statistical data or GLP data to a personal computer, use the USB converter (AX-USB-9P-EX)

### HRA-08 Ethernet interface

- Used to connect the balance to a LAN.
- The "WinCT-Plus" data communication software is provided as a standard accessory and can perform the following.
  - Acquire data from multiple balances connected to a LAN.
  - Control these balances with commands.
  - Acquire data transmitted from balances.  
Example: When pressing the **PRINT** key of the balance, data is output and is acquired by the computer.
  - The stored data can be used with Microsoft Excel (if installed).

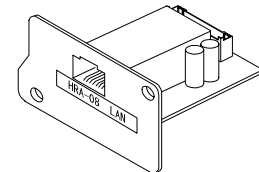

HRA-08 Example of use

	FX-300i		FX-3000i	
1	11:19:43 ST	+0018.225	g	11:20:02 ST +02019.24 g
2	11:19:49 ST	+0018.225	g	11:20:05 ST +02019.26 g
3	11:21:07 ST	+0016.295	g	11:20:12 ST +02019.28 g
4	11:21:12 ST	+0018.226	g	11:20:39 ST +02232.58 g
5	11:21:17 ST	+0018.223	g	11:20:47 ST +02019.27 g
6	11:21:33 ST	+0019.667	g	11:23:02 ST +02019.27 g
7	11:21:41 ST	+0018.225	g	11:23:09 ST +02019.26 g
8	11:21:51 ST	+0018.225	g	11:23:16 ST +01863.45 g
9	11:22:00 ST	+0018.224	g	
10	11:22:30 ST	+0018.226	g	
11	11:22:33 ST	+0018.225	g	
12	11:22:40 ST	+0016.293	g	
13	11:22:53 ST	+0018.225	g	

### HRA-09 Built-in battery unit (Ni-MH rechargeable battery pack)

- Charging time: Approximately 10 hours.
- Continuous operation hours: Approximately 8 hours

## Note

The charging time depends on the operating environment. During charging, the balance is not available for use.

### **AX-HRA-31 Main unit cover**

- Main unit protective cover provided as a standard accessory.

### **AD-1683 DC static eliminator**

- Used to minimize weighing errors due to static electricity on the material.  
The AD-1683 is direct-current static eliminator. The ions generated produce no breeze and are effective over a long distance. Therefore, the balance can accurately weight powders, etc. by using the AD-1683.

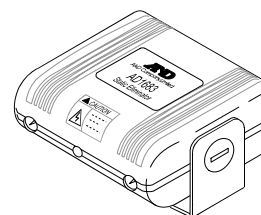

### **AD-1684 Electrostatic field meter**

- This option measures the amount of the static charge on the sample, tare or peripheral equipment and displays the result.  
If those are found to be charged, discharge them using the AD-1683 DC static eliminator.

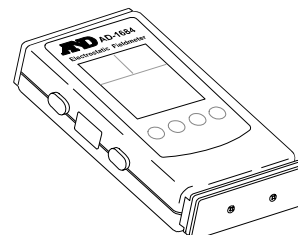

### **AD-1688 Data logger**

- When connected to the RS-232C interface of the balance, the AD-1688 can store the data in an environment where a personal computer can not be used.

### **AD-1689 Tweezers for calibration weight**

- This option is used when calibrating the balance using an external weight.

### **AX-USB-9P-EX USB converter**

- Adds a COM port to a PC.
- Enables bi-directional communication between the PC and the balance when a USB driver is installed.
- Can use serial communication software such as WinCT on a PC without COM ports.

### **AD-8920A Remote display**

- Connected to the balance using the RS-232C serial interface to display the weight data away from the balance.

### **AD-8922A Remote controller**

- Connected to the balance using the RS-232C serial interface to display the weight data and to remotely control the balance.
- Analog output and comparator output available as an option to be installed.

### **AD-8121B Printer**

- Compact dot-matrix printer
- Statistical function, clock and calendar function, interval print function, graphic print function, dump print mode
- 5 x 7 dots, 16 characters per line
- Print paper (AX-PP143, 45 (W) x 50 (L) mm, ø65 mm)
- AC adapter or alkaline battery.

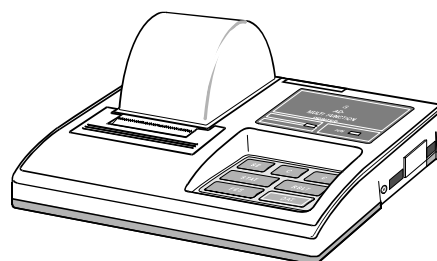

## 21. SPECIFICATIONS

	HR-250AZ	HR-150AZ	HR-100AZ	HR-250A	HR-150A	HR-100A
Weighing capacity	252g	152g	102g	252g	152g	102g
Maximum display	252.0084g	152.0084g	102.0084g	252.0084g	152.0084g	102.0084g
Minimum weighing value (1 digit)	0.1mg					
Repeatability (Standard deviation)	0.1mg/0~200g 0.2mg/200~250g	0.1mg		0.1mg/0~200g 0.2mg/200~250g	0.1mg	
Linearity	±0.3mg	±0.2mg		±0.3mg	±0.2mg	
Stabilization time (typical at FAST)	Approx. 2 second <sup>*1</sup>					
Sensitivity drift (10°C-30°C/50°F-86°F)	±2 ppm/°C					
Internal mass	Yes			No		
Clock and calendar function	Yes			No		
Operating environment	5°C to 40°C (41°F to 104°F) 85%RH or less (No condensation)					
Display refresh rate	5 times/second <sup>*2</sup> , 10 times/second					
Counting mode	Minimum unit mass					
	Number of samples					
Percent mode	Minimum 100% reference mass					
	Minimum 100% display					
Interface	RS-232C					
External calibration weight	250g 200g 100g 50g	150g 100g 50g	100g 50g	250g 200g 100g 50g	150g 100g 50g	100g 50g
Weighing pan diameter	90 mm					
External dimensions	198(W) x 294(D) x 315(H) mm					
AC adapter	Confirm that the adapter type is correct for the local voltage and power receptacle type					
Power consumption	Approx. 11VA (supplied to the AC adapter)					
Net weight	Approx. 3.9 kg			Approx. 3.5 kg		

\*1: When factory setting is set to **[MID.]**, the stabilization time is approx. 3 seconds.

\*2: When factory setting, the display refresh rate is 5 times/second.

## 22. EXTERNAL DIMENSIONS

HR-100A / 150A / 250A  
 HR-100AZ / 150AZ / 250AZ

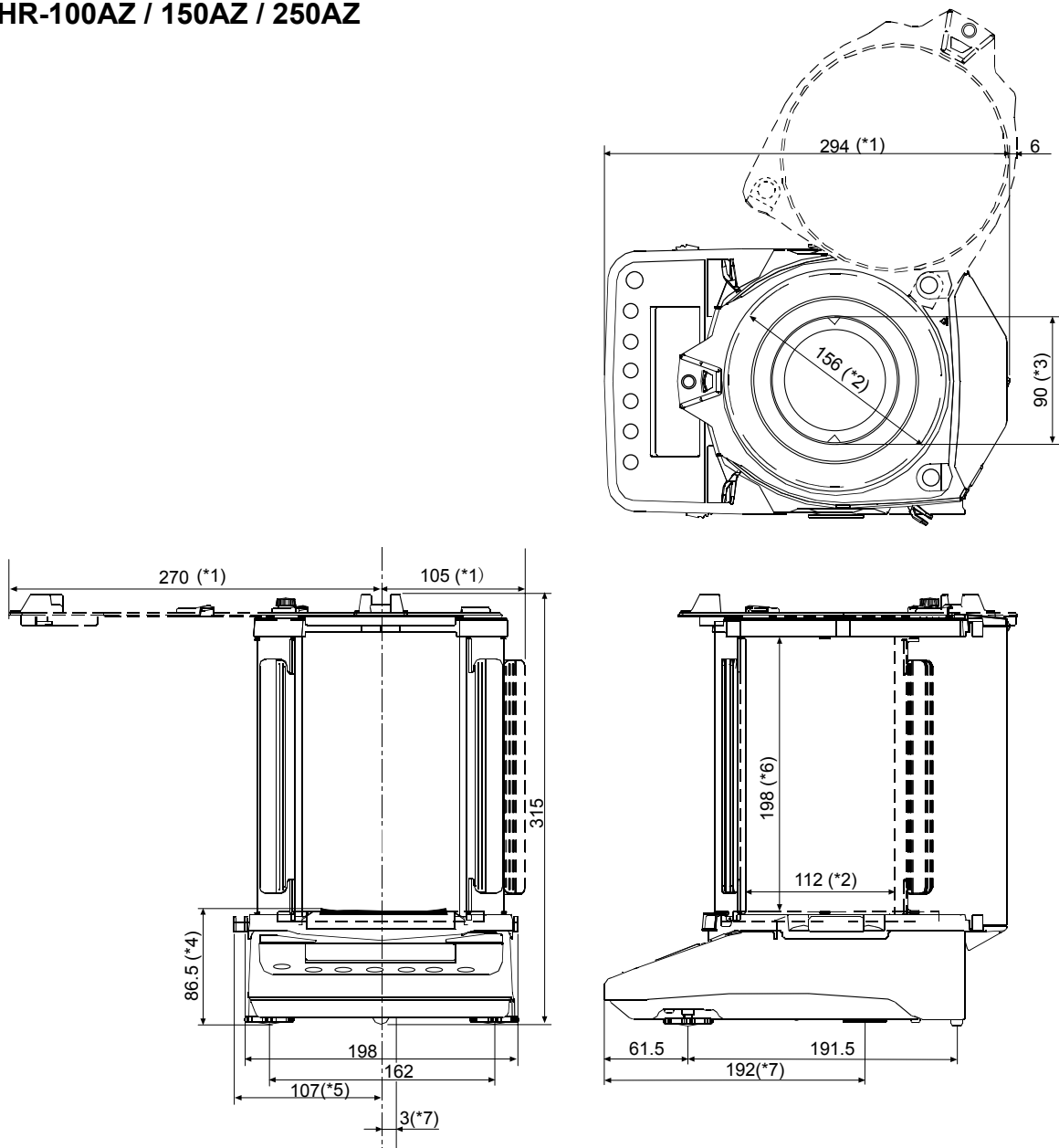

- \*1: When opening maximum
- \*2: Inside dimension
- \*3: Weighing pan diameter
- \*4: Height up to the weighing pan
- \*5: When pulling out the locking handle
- \*6: Inside dimension (from up to the weighing pan)
- \*7: Underhook position (hole center)

Unit: mm











## 23. TERMS/INDEX

### Terms

<b>Stable value</b>	The weight data when the stabilization indicator appears.
<b>Environment</b>	Ambient conditions such as vibration, drafts, temperature, static electricity and magnetic fields which affect the weighing operation.
<b>Calibration</b>	Adjustment of the balance so that it can weigh accurately.
<b>Output</b>	To output the weight data using the RS-232C serial interface.
<b>Zero point</b>	A weighing reference point or the zero display. Usually refers to the value displayed when nothing is on the weighing pan.
<b>Digit</b>	Unit of digital resolution. Used for the balance, a unit of minimum weighing value.
<b>Tare</b>	To cancel the weight of a container which is not included in the weight data.
<b>Mode</b>	Balance operational function.
<b>Re-zero</b>	To set the display to zero.
<b>GLP</b>	Good Laboratory Practice.
<b>Repeatability</b>	Variation in measured values obtained when the same weight is placed and removed repetitively. Usually expressed as a standard deviation. e.g. Standard deviation=1 digit: This means that measured values fall within $\pm 1$ digit in the frequency of about 68%.
<b>Stabilization time</b>	Time required after a sample being placed, until the stabilization indicator illuminates and the weight data is displayed.
<b>Sensitivity drift</b>	An affect that a change in temperature causes to the weight data. Expressed as temperature coefficient. e.g. Temperature coefficient = 2 ppm/ $^{\circ}$ C : If a load is 200 g and the temperature changes by 10 $^{\circ}$ C, the value displayed changes by the following value. $0.0002\%/^{\circ}$ C x 10 $^{\circ}$ C x 200 g = 4 mg

## Index

### Keys and symbols

	ON/OFF key.....	9
	SAMPLE key.....	9
	MODE key.....	9
	CAL key.....	9
	PRINT key.....	9
	RE-ZERO key.....	9
	Stabilization indicator.....	9
	Interval output mode active indicator.....	9
	Interval output mode standby indicator.....	9
	Processing indicator.....	9
$C_R$	CR.....	44
$L_F$	LF.....	44
	Space.....	44
	100% reference mass.....	16

### - A -

	A&D standard format.....	38, 42
	AC adapter.....	5
	AC adapter ID label.....	5
	ACAI.....	15
	AD-1683.....	7, 8, 72
	AD-1684.....	72
	AD-1689.....	72
	AD-8121B.....	52, 61, 72
	AD-8920A.....	72
	AD-8922A.....	72
	AK.....	65
	Animal mode indicator.....	9
$AP F_{nc}$	Application.....	17, 38
$AP-b$	Auto print difference.....	37
$APF$	Application function.....	17, 38
$AP-P$	Auto print polarity.....	37, 61
	Application.....	17, 38
	Application function.....	17, 38
$Ar-d$	Zero after output.....	37
$At-F$	Auto feed.....	37
	Auto display-OFF.....	36, 40
	Auto display-ON.....	36, 40
	Auto print difference.....	37
	Auto print mode A.....	37, 41
	Auto print mode B.....	37, 41
	Auto print polarity.....	37
$A_{\bar{U}E}$	Average.....	19
	Average.....	17, 19, 38

	AX-HRA-31.....	72
	AX-USB-9P-EX USB converter.....	72

### - B -

$b_{ASF_{nc}}$	Environment display.....	12, 36
	Baud rate.....	37, 60, 61
$bEEP$	Beep.....	36
$bEP-$	HI buzzer.....	36
$bEP-$	LO buzzer.....	36
$bEP-$	OK buzzer.....	36
$bPS$	Baud rate.....	38, 61
	Breeze break.....	5
	Breeze break ring.....	5
$b_tPr$	Data bit, parity bit.....	38, 61
	Built-in battery unit.....	71

### - C -

$[AL E$	Calibration weight error.....	69
$-[AL E$	Calibration weight error.....	69
$[S in \{ 2$	Internal mass value correction.....	27, 28, 38
	CAL key.....	9, 26
	Calibration ...	9, 25, 28, 29, 30, 34, 49, 69, 75
	Calibration report.....	30, 49
	Calibration test.....	31, 49
	Calibration test report.....	32, 49
$[CANCEL$	.....	19
	Capacity indicator.....	9, 38, 45
$[L Add$	Clock.....	36, 44, 50
$[CLEAR$	.....	19
	Coefficient of variation.....	17, 19, 38
	Command list.....	64
	Comparator function.....	48
	Comparator indicators.....	9
$[Cond$	Condition.....	36, 39
	Counting mode.....	14
$[P$	Comparator mode.....	36
$[P F_{nc}$	Comparator.....	36, 38
$[P H_i$	Upper limit.....	37
$[P L_o$	Lower limit.....	37
$[rLF$	Terminator.....	38, 61
	CSV format.....	38, 43, 44
$[CV$	Coefficient of variation.....	19

## - D -

Data bits .....	60
Data format .....	38
Data output mode.....	37
Data output pause.....	37
DC static eliminator .....	7, 8, 72
DCE .....	60, 62
Decimal point.....	36, 40
Digit .....	36, 40, 75
Display at start .....	36
Display refresh rate .....	36, 40
<i>dout</i> Data output.....	37
DP format .....	38, 42
DTE .....	60
Dust plate.....	5

## - E -

-E .....	69
EC, E00 .....	70
EC, E01 .....	70
EC, E02 .....	70
EC, E03 .....	70
EC, E04 .....	70
EC, E06 .....	70
EC, E07 .....	70
EC, E11 .....	69
EC, E20 .....	69
EC, E21 .....	69
Electrostatic field meter .....	72
End block .....	52
<i>ErCd</i> Error code .....	38
<i>Error1</i> .....	69
<i>Error2</i> .....	69
Ethernet interface .....	71
External dimensions.....	73, 74

## - F -

<b>FAST</b> .....	24
Function table .....	35
HRA-02 .....	71
HRA-08 .....	71
HRA-09 .....	71

## - G -

GLP .....	49
-----------	----

GLP output .....	25, 30, 31, 37, 50
Grounding terminal .....	5

## - H -

<i>Hold</i> Hold function .....	36, 39
---------------------------------	--------

## - I -

ID number .....	49
<i>info</i> GLP output .....	37
Inhibit .....	33
Initializing the balance.....	34
<i>int</i> Interval time .....	37
Interval output mode .....	37, 42
Interval output mode active indicator .....	9
Interval output mode standby indicator .....	9
Interval time .....	37

## - K -

Key mode .....	37, 41
Key mode B .....	37, 41
Key mode C .....	37, 41
KF format .....	38, 43

## - L -

Large breeze break .....	5
Leveling foot .....	5
Linearity .....	73
<i>L0</i> .....	69
Lower limit value .....	48

## - M -

Main unit cover .....	5, 72
<i>mAll</i> Maximum.....	19
<i>mAll%</i> Relative error of maximum value .....	19
Maximum .....	17, 19, 38
Maximum display .....	73
<b>MID</b> .....	24
<i>m in</i> Manimum.....	19
<i>m in%</i> Relative error of minimum value .....	19
Minimum .....	17, 19, 38
Minimum 100% reference mass.....	73
Minimum unit mass.....	73
Minimum weighing value.....	73
<b>MODE</b> key .....	9, 10, 12
MT format .....	38, 43

## - N -

NU format .....	38, 43
Number of data.....	17, 38

## - O -

<b>ON:OFF</b> key.....	9, 34
Operating environment.....	73

## - P -

Pan support .....	5
Parity .....	60
<i>PCS</i> .....	14
Percent Mode .....	16
Permit .....	33
<i>Pnt</i> Decimal point .....	36, 40
<i>PoFF</i> Auto display-OFF.....	36, 40
<i>P-on</i> Auto display-ON.....	36, 40
<b>PRINT</b> key.....	9, 12
Printer .....	61, 72
Processing indicator.....	9
Programmable unit.....	54
<i>Prt</i> Data output mode .....	37, 61
<i>PUSE</i> Data output pause .....	37, 61

## - R -

<i>r</i> Range.....	19
Range .....	17, 19, 38
<i>READY</i> .....	28
<i>REMARKS</i> Remarks output.....	37
Remote controller.....	72
Remote display.....	72
Repeatability .....	73
Response indicators .....	9, 23
RE-ZERO key .....	8, 9
<i>rnG</i> Display at start.....	36
RS-232C .....	60, 62
RsCom .....	62
RsKey .....	62
RsWeight .....	62

## - S -

<b>SAMPLE</b> key.....	9, 12
<i>sd</i> Standard deviation.....	19
Sensitivity drift.....	73

<i>SiF</i> Serial interface.....	38
SLOW .....	23
<i>SPd</i> Display refresh rate.....	36, 40
Stability band width .....	39
Stabilization indicator .....	9
Stabilization time .....	73
Standard deviation .....	17, 19, 38
Standby indicator .....	9
<i>StRF</i> Statistical function mode output items .....	18, 38
Statistical calculation mode .	3, 17, 18, 38, 45
Statistical function mode output items .....	38
<i>St-b</i> Stability band width.....	36, 39
Stop bit .....	60
Stream mode .....	37, 41
<i>Sum</i> Sum.....	19
Sum .....	17, 19, 38

## - T -

Tare .....	13, 14, 16, 22
Terminator .....	38
Timeout .....	38
Title block .....	60
Transmission form .....	60
Transmission rate .....	60
Transmission system.....	60
<i>trc</i> Zero tracking.....	36, 40
<i>t-UP</i> Timeout .....	38
<i>tYPE</i> Data format .....	38, 61

## - U -

Underhook.....	58
Units .....	9, 10, 12
Upper limit value .....	48
USB interface.....	71

## - W -

Weighing .....	13
Weighing capacity.....	8, 45, 69, 73
Weighing pan .....	5
Weighing pan diameter .....	73
Weighing units.....	10
WinCT .....	62

## - V -

Zero tracking .....	40
---------------------	----





