

MC series

Mass comparator

INSTRUCTION MANUAL

MC-10K
MC-30K



AND

A&D Company, Limited

1WMPD4002203B

This Manual and Marks

All safety messages are identified by the following, "WARNING" or "CAUTION", of ANSI Z535.4 (American National Standard Institute: Product Safety Signs and Labels). The meanings are as follows:

 WARNING	A potentially hazardous situation which, if not avoided, could result in death or serious injury.
 CAUTION	A potentially hazardous situation which, if not avoided, may result in minor or moderate injury.



This is a hazard alert mark.

- This manual is subject to change without notice at any time to improve the product.
- The contents of the product specifications and this manual are subject to change without any obligation on the part of the manufacturer.
- Under the copyright laws, the software (program) described in it are copyrighted, with all rights reserved.
The software may be installed into one computer and may not be installed into other computers without the prior written consent of A&D Company. Copying includes translation into another language, reproduction, conversion, photocopy and offer or loan to another person.

- Microsoft, Windows, Word and Excel are registered trademarks of the Microsoft Corporation.

© 2016 A&D Company, Limited All rights reserved.

No part of this publication may be reproduced, transmitted, transcribed, or translated into any language in any form by any means without the written permission of A&D Company, Limited.

Contents

Basic Operation

1.	Introduction	3
1-1.	About This Manual	3
1-2.	Features	3
1-3.	Compliance	4
1-3-1.	Compliance with FCC Rules	4
1-3-2.	Compliance With Directives of CE mark	4
2.	Unpacking And Installing The Balance	6
2-1.	Auto-centering Pan (AX-MC10K/30KPAN) Installation Procedure	7
2-2.	Installing the Balance	8
3.	Precautions	9
3-1.	Before Use	9
3-2.	During Use	10
3-3.	After Use	10
3-4.	Power Supply	11
4.	Display Symbols And Key Operation	12
5.	Weighing Units	13
6.	Weighing	15
6-1.	Selecting a Weighing Unit (Mode)	15
6-2.	Basic Weighing	15
6-2-1.	For More Stable Weighing	15
6-2-2.	When Using as a Mass Comparator	15
6-2-3.	When Building into a System	16

Adapting to the Environment

7.	Weighing Speed Adjustment / Self Check Function	17
7-1.	Weighing Speed Adjustment	17
7-2.	Self Check Function with Response Adjustment	18
8.	Calibration	19
8-1.	Calibration Group	19
8-2.	Automatic Self Calibration	20
8-3.	One-Touch Calibration	21
8-4.	Calibration Using an External Weight	22
8-5.	Calibration Test Using an External Weight	23
8-6.	Correcting the Internal Mass Value	24

Functions

9.	Function Switch And Initialization	26
9-1.	Permit or Inhibit	26
9-2.	Initializing the Balance	27
10.	Function Table	28
10-1.	Structure and Sequence of the Function Table	28
10-2.	Display and Operation Keys	28
10-3.	Details of the Function Table	29
10-4.	Description of the Class "Environment, Display"	33
10-5.	Description of the Item "Data Output Mode"	34

10-6.	Description of the Item "Data Format"	35
10-6-1.	Description of the Data Format Added to the Weighing Data	37
10-7.	Data Format Examples	38
11.	ID Number And GLP Report.....	39
11-1.	Setting the ID Number	39
11-2.	GLP Report.....	40

RS-232C Serial Interface

12.	Standard Input And Output Interface	43
12-1.	RS-232C and External Contact Input	43
12-2.	Connection to Peripheral Equipment.....	45
12-2-1.	Connection to the AD-8121B Printer	45
12-2-2.	Connection to a Computer and the Use of WinCT.....	46
13.	Commands.....	47
13-1.	Command List	47
13-2.	Acknowledge Code and Error Codes	48
13-3.	Control Using CTS and RTS	49
13-4.	Settings Related to RS-232C	49
14.	Extended Function	50
14-1.	Description of "Averaging range" and "Averaging time"	51
14-1-1.	Averaging Range ($F I-b$) and Averaging Time ($F I-t$).....	51
14-1-2.	Filter Depending on Differences in the Amount to Deliver Powdery and Liquid Material.....	52

Maintenance

15.	Maintenance	53
15-1.	Treatment of the Balance	53
16.	Troubleshooting	54
16-1.	Checking the Balance Performance and Environment	54
16-2.	Error Codes	55
16-3.	Other Display	57
16-4.	Asking for Repair	57
17.	Specifications	58
17-1.	External Dimensions	59
17-2.	Options and Peripheral Instruments	60
18.	Terms/Index	63
18-1.	Terms	63
18-2.	Index	65

1. Introduction

This manual describes how the MC Series Mass Comparator Balances, MC-10K and MC-30K, work and how to get the most out of them in terms of performance.

Read this manual thoroughly before using the balance and keep it at hand for future reference.

For other functions and operations that this manual does not describe, refer to the GX-K series instruction manual.

1-1. About This Manual

This manual consists of the following five parts:

Basic operationDescribes precautions, the balance's construction and basic operation.

Adapting to the environment.....Describes response (and stability) adjustment to adapt to the environment where there is vibration or drafts, the way to maintain weighing precision in a variation of ambient temperature, calibration and calibration test.

Selecting functions.....Describes functions of the balance.

Interface and communication....Describes the RS-232C serial interface and external contact input. The RS-232C serial interface can communicate with a computer that requests weighing data and controls the balance. This RS-232C interface is for use with a computer or printer. The external contact input commands the balance re-zeroing and data output.

MaintenanceDescribes maintenance, error codes, troubleshooting, specifications and options.

1-2. Features

- Display resolution, one digit greater than a standard balance. This allows management of OIML class F1 or lower weights.
- Capable of weighing small amounts of powdery or liquid material, even with a massive tare.
- When used as a mass comparator, the balance can achieve even more precise weighing, by using the optional auto-centering pan (sold separately), which reduces eccentric loading errors.

1-3. Compliance

1-3-1. Compliance with FCC Rules

Please note that this equipment generates, uses and can radiate radio frequency energy. This equipment has been tested and has been found to comply with the limits of a Class A computing device pursuant to Subpart J of Part 15 of FCC rules. These rules are designed to provide reasonable protection against interference when equipment is operated in a commercial environment. If this unit is operated in a residential area, it may cause some interference and under these circumstances the user would be required to take, at his own expense, whatever measures are necessary to eliminate the interference.

(FCC = Federal Communications Commission in the U.S.A.)

1-3-2. Compliance With Directives of CE mark

CE This device features radio interference suppression, safety regulation and restriction of Hazardous Substances in compliance with the following Council Directives

Council directive 2004/108/EC	EN61326	EMC directive
Council directive 2006/95/EC	EN60950	Safety of Information Technology Equipment
Council directive 2011/65/EU	EN50581	Restriction of the use of certain Hazardous Substances

- The CE mark is an official mandatory European marking.
Please note that any electronic product must comply with local laws and regulations when sold or used anywhere outside Europe.



A & D Instruments Ltd. hereby declare that the following Weighing product conforms to the requirements of the council directives on ...

**Electromagnetic Compatibility (EMC) 2004/108/EC,
Low Voltage Equipment (LVD) 2006/95/EC amended by 93/68/EEC and
Restriction of the use of certain Hazardous Substances (RoHS) 2011/65/EU**

provided that they bear the CE mark of conformity.

Model/Series....MC-K Series

Standards applicable:

EN 61326-1:2013

Electrical equipment for measurement, control and laboratory use -EMC requirements Part 1: General requirements

EN 60950-1:2006+A11:2009+A1:2010.A11:2012

Safety of Information Technology Equipment

EN 50581:2012

Technical documentation for the assessment of electrical and electronic products with respect to the restriction of hazardous substances

CE Mark first applied 09 November 2010

Signed for A&D Instruments in Oxford England 01 August 2015

P. Argus
Managing Director

2. Unpacking And Installing The Balance

- The balance is a precision instrument. Unpack the balance carefully. Keep the packing material to be used for transporting the balance in the future.
- The packing contents depend on the balance model. See the illustrations to confirm that everything is included.

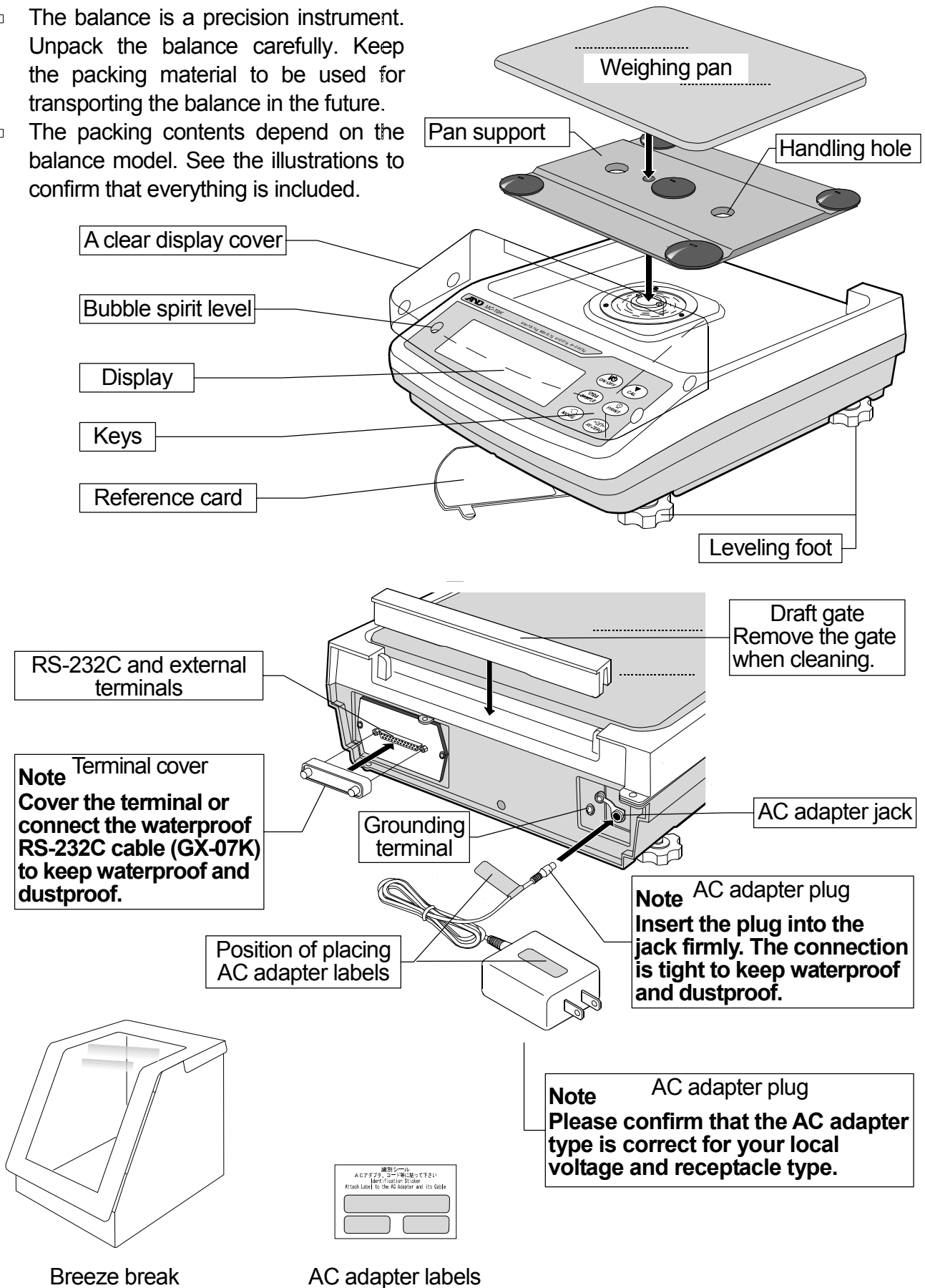

2-1. Auto-centering Pan (AX-MC10K/30KPAN) Installation Procedure

Caution: During installation, do not to apply excessive force to the balance.

- **When used as a mass comparator, the balance can achieve even more precise weighing, by using the auto-centering pan (sold separately), which reduces eccentric loading errors.**

1. Place the pan support on the balance. Place the breeze break provided with the AX-MC10K/30KPAN option on the balance. Place the auto-centering pan guide on the pan support, and then place the auto-centering pan on the auto-centering pan guide.

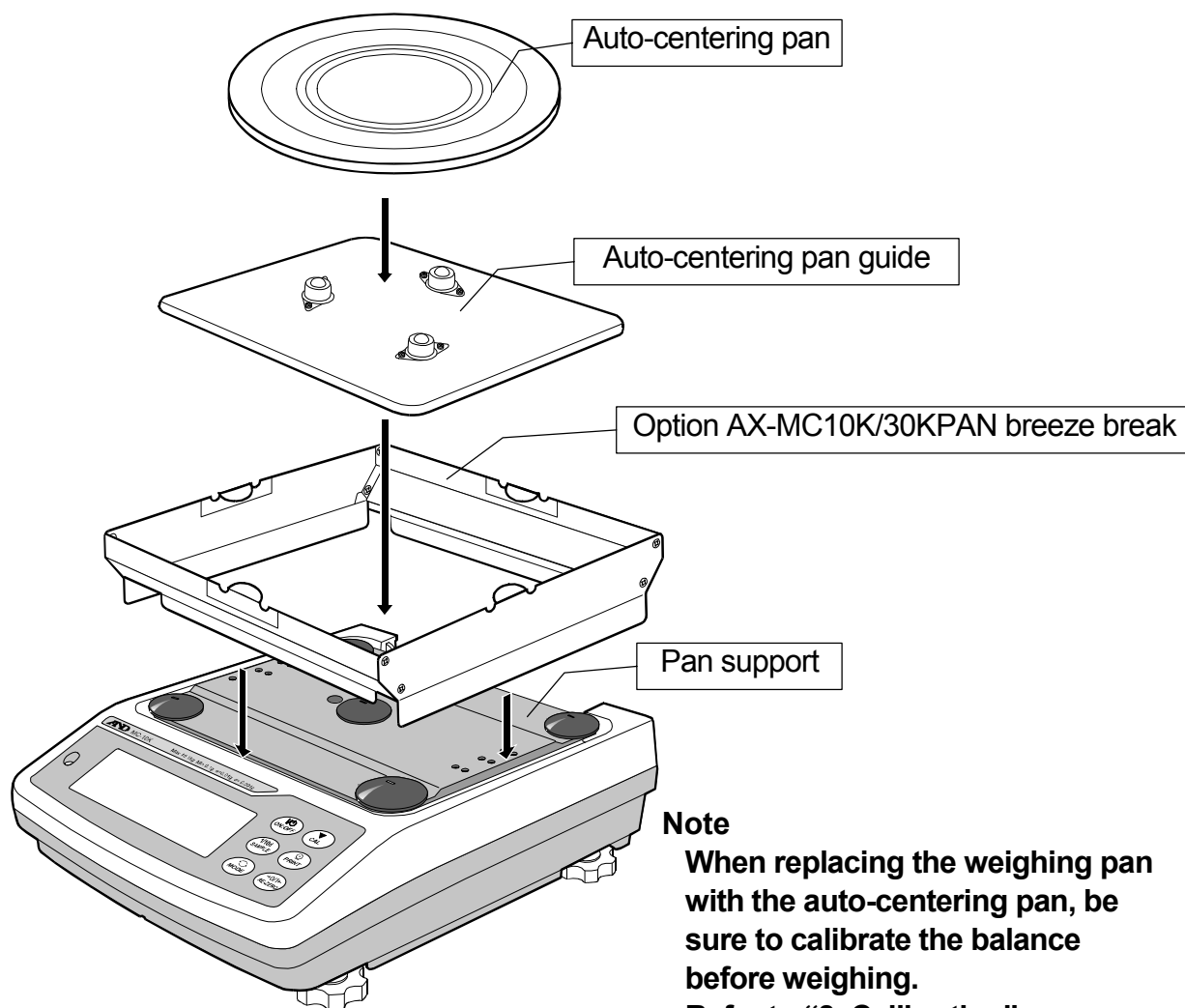

2-2. Installing the Balance

Install the balance as follows:

- 1 Refer to "3. Precautions" for installing the balance.
- 2 Install the pan support, weighing pan and draft gate. Refer to the previous page.
- 3 Adjust the leveling feet to level the balance. Confirm it using the bubble spirit level.
- 4 Confirm that the AC adapter type is correct for the local voltage and power receptacle type.
- 5 Connect the AC adapter to the balance firmly. Earth the balance. Warm up the balance for at least 30 minutes with nothing on the weighing pan.

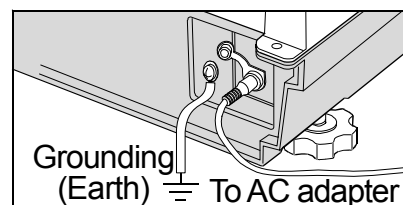
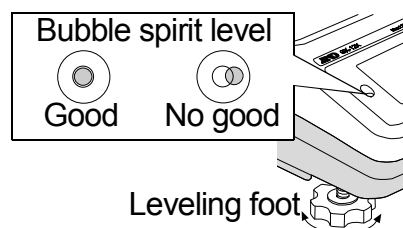

3. Precautions

To get the optimum performance from the balance and acquire accurate weighing data, note the following:

3-1. Before Use

- The maximum resolution of the precision balance is ten million counts. Therefore, there are tendencies to be influenced by temperature change, air pressure change, static electricity, vibration and drafts where the balance is placed.
- Install the balance in an environment where the temperature and humidity are not excessive. The best operating temperature is about 20°C / 68°F at about 50% relative humidity.
- Install the balance where it is not exposed to direct sunlight and it is not affected by heaters or air conditioners.
- Install the balance where it is free of dust.
- Install the balance away from equipment that produces magnetic fields.
- Install the balance in a stable place avoiding vibration and shock. Corners of rooms on the first floor are best, as they are less prone to vibration.
- The weighing table should be solid and free from vibration, drafts and as level as possible.
- Level the balance by adjusting the leveling feet and confirm it using the bubble spirit level.
- If static electricity is a problem at the installation site, use the electrostatic field meter and the static eliminator.
- Ensure a stable power source when using the AC adapter.
- Connect the AC adapter and warm up the balance for at least 30 minutes.
- Calibrate the balance periodically for accurate weighing.
- When the balance is installed for the first time or has been moved, warm up the balance for at least 6 hours to allow the balance to reach equilibrium with the ambient temperature, and then perform calibration before use.
- The meaning of IP-65 is "No ingress of dust. Projected against water jets". If a powerful water jet is used or the balance is immersed in water, it may cause a damage that is due to ingress of water.
- Confirm that "the plug is inserted firmly into the jack" and "the terminal is covered using the waterproof cover or the waterproof RS-232C cable (GX-07K)", when using the balance.
- Use the waterproof option cable GX-07K, when the RS-232C interface is used with IP-65. AX-KO1710-200, a standard RS-232C cable, is not waterproof or dustproof.
- Confirm that the weighing pan does not touch to rim.

 Do not install the balance where flammable or corrosive gas is present.

3-2. During Use

- Discharge static electricity from the weighing material. When weighing sample (plastics, insulator, etc.) could have a static charge, the weighing value is influenced. Ground the balance, and
 - Eliminate the static electricity by using an optimal static eliminator, AD-1683.
 - Or try to keep the ambient humidity above 45%RH at the room.
 - Or use the metal shield case.
 - Or wipe a charged material (plastic sample etc.) with the wet cloth.
- This balance uses a strong magnet as part of the balance assembly, so please use caution when weighing magnetic materials such as iron. If there is a problem, use the underhook on the bottom of the balance to suspend the material away from the influence of the magnet.
- Eliminate any temperature difference between the sample and the environment. When a sample is warmer (cooler) than the ambient temperature, the sample will be lighter (heavier) than the true weight. This error is due to a rising (falling) draft around the sample.
- Make each weighing gently and quickly to avoid errors due to changes in the environmental conditions.
- Do not drop things upon the weighing pan, or place a sample on the pan that is beyond the balance weighing capacity. Place the sample in the center of the weighing pan.
- Do not use a sharp instrument such as a pencil to press the keys. Use your finger only.
- Press the RE-ZERO key before each weighing to prevent possible errors.
- Calibrate the balance periodically so as to eliminate possible errors.
- Take into consideration the affect of air buoyancy on a sample when more accuracy is required.
- It is possible to check the reference card for principle operation.
- Prevent foreign matter, such as powder, liquid and metal, from invading the area around the weighing pan.
- Use the "breeze break" for a precision weighing.

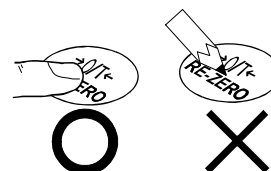
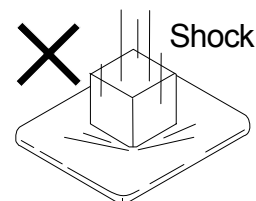
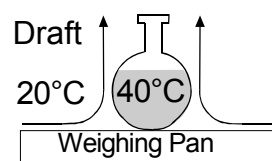
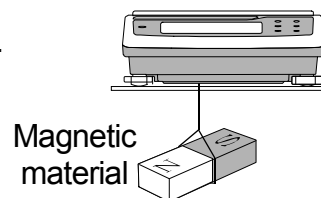
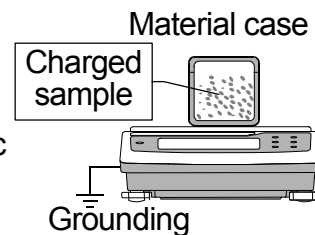

3-3. After Use

- Avoid mechanical shock to the balance.
- Do not disassemble the balance. Contact the local A&D dealer if the balance needs service or repair.
- Do not use organic solvents to clean the balance. Clean the balance with a lint free cloth that is moistened with warm water and a mild detergent.

- Do not allow the balance to be immersed in water. Even though the balance complies with IP code, the balance will not withstand being completely immersed in water.
- The weighing pan, pan support and draft gate can be removed to clean the balance. Clean by splashing with water.
- Use the waterproof option RS-232C cable GX-07K, when RS-232C interface is used with IP-65. AX-KO1710-200, a standard RS-232C cable, is not waterproof or dustproof.

3-4. Power Supply

- Do not remove the AC adapter while the internal mass is in motion, for example, right after the AC adapter is connected, or during calibration using the internal mass. If the AC adapter is removed under the conditions described above, the internal mass will be left unsecured, that may cause mechanical damage when the balance is moved. Before removing the AC adapter, press the key and confirm that zero is displayed.
- When the AC adapter is connected, the balance is in the standby mode if the standby indicator is on. This is a normal state and does not harm the balance. For accurate weighing, keep the AC adapter connected to the balance and AC power unless the balance is not to be used for a long period of time.

4. Display Symbols And Key Operation

Key Operations

Key operation affects how the balance functions. The basic key operations are:



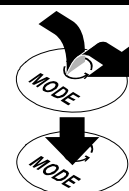

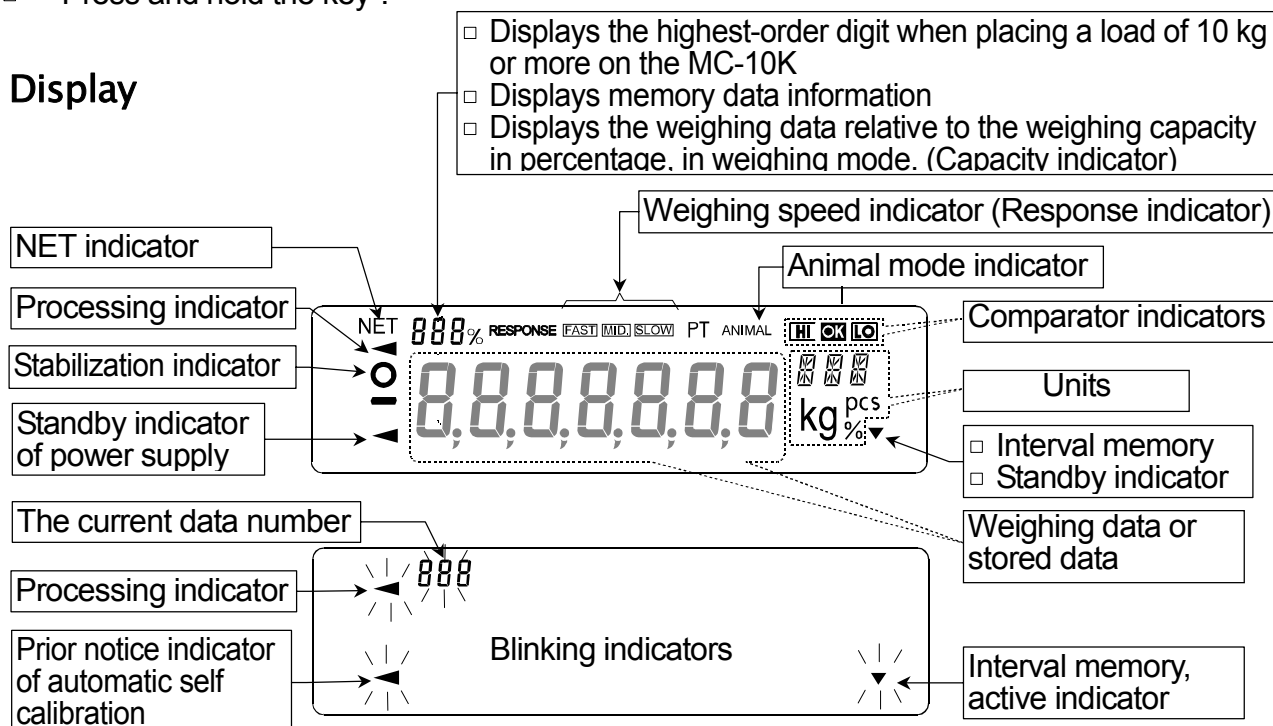

- "Press and release the key immediately" or "Press the key"
= normal key operation during measurement
- "Press and hold the key".



Display



Each key, when pressed or when pressed and held, functions as follows:

Key	When pressed and released	When pressed and held
	Turns the display ON and OFF. The standby indicator is displayed when the display is turned off. The weighing mode is enabled when the display is turned on. This key is available anytime. Pressing the key during operation will interrupt the operation and turn the display OFF.	
	In the weighing mode, turns the minimum weighing value ON and OFF. In the counting or percent mode, enters the sampling mode.	Enters the function table mode. Refer to "10. Function Table".
	No function at the factory setting. Switches the weighing units when units other than "g" are stored in the function setting.	Performs weighing speed adjustment (response adjustment) and self check.
	Performs calibration using the internal mass.	Displays other items of the calibration menu.
	Stores the weighing data in memory or outputs to a printer or personal computer depending on the function table settings. (Factory setting = output)	No function at the factory setting. By changing the function table: <ul style="list-style-type: none"> □ Outputs "Title block" and "End block" for GLP report. Refer to "11-2. GLP Report". □ Displays the data memory menu.
	Sets the display to zero.	

5. Weighing Units

- With the balance, only the unit “g” (gram) was set at the factory. The following weighing units and weighing modes are available for selection:

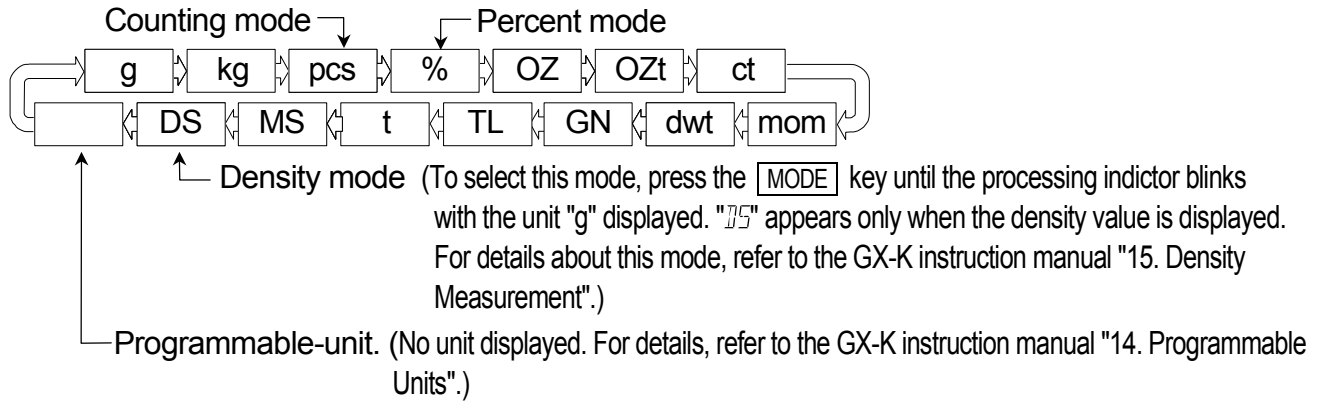

A unit or mode can be selected and stored in the function table as described in the GX-K series instruction manual "5-2. Changing the Units".
 If a weighing mode (or unit of weight) has been turned off, that mode or unit will be missing in the sequence. Tael has four varieties, one of which can be selected and installed at the factory.

For details about the units and modes, see the table below:

Name (unit, mode)	Abbreviation	Display	Function table (Storing mode)	Conversion factor 1 g =
Gram	g	g	g	1 g
Kilogram	kg	kg	kg	1000 g
Counting mode	pcs	pcs	pcs	—
Percent mode	%	%	%	—
Ounce (Avoir)	OZ	<i>OZ</i>	<i>OZ</i>	28.349523125 g
Troy Ounce	OZt	<i>OZt</i>	<i>OZt</i>	31.1034768 g
Metric Carat	ct	<i>ct</i>	<i>ct</i>	0.2 g
Momme	mom	<i>mom</i>	<i>mom</i>	3.75 g
Pennyweight	dwt	<i>dwt</i>	<i>dwt</i>	1.55517384 g
Grain (UK)	GN	<i>GN</i>	<i>GN</i>	0.06479891 g
Tael (HK general, Singapore)	TL	TL	TL	37.7994 g
Tael (HK jewelry)				37.429 g
Tael (Taiwan)				37.5 g
Tael (China)				31.25 g
Tola (India)	t	<i>t</i>	<i>t</i>	11.6638038 g
Messghal	MS	<i>MS</i>	<i>MS</i>	4.6875 g
Density mode	DS	<i>DS</i> is used to show the density	<i>DS</i>	—
Programmable-unit (Multi-unit)	Mlt	—	<i>Mlt</i>	—

- The tables below indicate the weighing capacity and the minimum display for each unit, depending on the balance model.
- When a measurement unit other than gram is used, it is not possible to weight up to capacity of the balance because the display does not have sufficient digits.
Use the MC series balance within the values shown in the tables below.

Unit	MC-10K		
	Capacity	Gram	Minimum display
Gram	10100 g	10100 g	0.001
Kilogram	10.1 kg	10100 g	0.000001
Ounce (Avoir)	197 OZ	5600 g	0.00005
Troy Ounce	199 OZt	6200 g	0.00005
Metric Carat	19500 ct	3900 g	0.005
Momme	1973 mom	7400 g	0.0005
Pennyweight	6494 dwt	10100 g	0.001
Grain (UK)	155866 GN	10100 g	0.02
Tael (HK general, Singapore)	198 TL	7500 g	0.00005
Tael (HK jewelry)	195 TL	7300 g	0.00005
Tael (Taiwan)	194 TL	7300 g	0.00005
Tael (China)	198 TL	6200 g	0.00005
Tola (India)	865 t	10100 g	0.0001
Messghal	1984 MS	9300 g	0.0005

Unit	MC-30K		
	Capacity	Gram	Minimum display
Gram	31000 g	31000 g	0.01
Kilogram	31.0 kg	31000 g	0.00001
Ounce (Avoir)	1093 OZ	31000 g	0.0005
Troy Ounce	966 OZt	31000 g	0.0005
Metric Carat	155000 ct	31000 g	0.05
Momme	8266 mom	31000 g	0.005
Pennyweight	1933 dwt	31000 g	0.01
Grain (UK)	478403 GN	31000 g	0.2
Tael (HK general, Singapore)	820 TL	31000 g	0.0005
Tael (HK jewelry)	828 TL	31000 g	0.0005
Tael (Taiwan)	826 TL	31000 g	0.0005
Tael (China)	992 TL	31000 g	0.0005
Tola (India)	2657 t	31000 g	0.001
Messghal	6613 MS	31000 g	0.005

6. Weighing

6-1. Selecting a Weighing Unit (Mode)

Press the **MODE** key to select a unit or mode for weighing.

The unit “g” (gram) was set at the factory.

To use other units, select and store units and displaying order in the function setting of “Unit”.

For details on weighing unit storing procedure, refer to the GX-K series instruction manual, “5-2. Changing the Units”.

6-2. Basic Weighing

6-2-1. For More Stable Weighing

- To reduce the influence of drafts and vibration, set the following function settings as below.

“Condition (Cond)” of “Environment, Display (bR5FnC)” to “Slow (2)”

“Filter (FIL)” of “Environment, Display (bR5FnC)” to “Used (I)”

Function Settings

Refer to “10. Function Table” on page 27 to check or change the function settings.

Class	Item and Parameter			Description
bR5FnC	Cond	Condition	2	Slow response rate, stable value SLOW
Environment Display	FIL	Filter	I	Used

6-2-2. When Using as a Mass Comparator

- To avoid eccentric loading errors, place the sample in the center of the weighing pan. As an option, AX-MC10K/30KPAN auto-centering pan is available. Using an AD-8922A remote controller, which is sold separately, the balance can be controlled remotely by the AD-8922A key operations in the same way as when the **CAL** or **RE-ZERO** key of the balance is pressed. For the connection procedure between the balance and the AD-8922A, refer to the AD-8922A instruction manual.
- Take measures against causes of weighing error at the installation site, such as changes in temperature, atmospheric pressure, drafts, vibration and static electricity. Perform weighing operations in a stable environment.
- The table below lists the weight class and recommended measuring range for each model of the MC series. The measuring range is determined so that the balance repeatability is to be less than one third of the maximum permissible error for each weight class.

Weight class and recommended measuring range

		M C - 1 0 K				M C - 3 0 K			
		F 1	F 2	M 1	M 2	F 1	F 2	M 1	M 2
Weight (Displayed value)	20 kg					↕	↕	↕	↕
	10 kg	↕	↕	↕	↕		↕	↕	↕
	5 kg	↕	↕	↕	↕			↕	↕
	2 kg	↕	↕	↕	↕			↕	↕
	1 kg		↕	↕	↕				↕
	500 g			↕	↕				
	200 g			↕	↕				
	100 g				↕				
	50 g				↕				

F 1
 F 2
 M 1
 M 2

6-2-3. When Building into a System

- When a special weighing pan is to be designed, the weight of the pan and the material to be weighed should not exceed the weighing capacity of the balance.
To reduce influences of static electricity and magnetism, use materials other than resin and magnetic material such as iron.
- When a special weighing pan is to be designed, the weight of the pan and the material to be weighed should not exceed the weighing capacity of the balance.
To reduce influences of static electricity and magnetism, use materials other than resin and magnetic material such as iron.
- There is a function available to maintain the previous weight value in non-volatile memory, even if the AC adapter is removed.
When “Zero upon power-on (P-t r)” of “Environment, Display (bR5FnC)” is set to “ I ”, the previous weight value is displayed upon power-on.
For details, refer to “Zero upon power-on” on page 32.
- There is a function available to perform span calibration only, when performing calibration with a tare on the weighing pan.
When “Span calibration (5Pn)” of “Environment, Display (bR5FnC)” is set to “ I ”, span calibration using the internal mass is performed, with a tare on the weighing pan.
For details, refer to “Span calibration” on page 32.
- To set a higher response rate (weighing speed) or to batch-weigh small amounts of material, such as a powdery material, refer to “14. Extended Function”.

7. Weighing Speed Adjustment / Self Check Function

7-1. Weighing Speed Adjustment

This function detects the influence on weighing that is caused by drafts and/or vibration at the place where the balance is installed and sets the following three weighing speeds (response characteristics) automatically.

The function has three rates as follows:

Changing the weighing speed changes the display refresh rate.

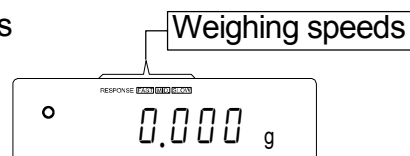

Indicator	Parameter	Weighing Speed	Stability	Display refresh rate
FAST	[Cond 0]	Fast response, ↑ Slow response,	Sensitive value ↓ Stable value	If the weighing speed is changed as follows: MID. or SLOW FAST =10 times/second FAST MID. or SLOW = 5 times/second
MID.	[Cond 1]			
SLOW	[Cond 2]			

Step 1 Press and hold the [MODE] key until [RESPONSE] is displayed. And then, press the [MODE] key again quickly.

Step 2 Press the [MODE] key to select a weighing speed. Either [FAST], [MID.] or [SLOW] can be selected.

Step 3 After a few seconds of inactivity the balance displays [End]. Then, it returns to the weighing mode and displays the updated response indicator. The response indicator remains displayed for a while.

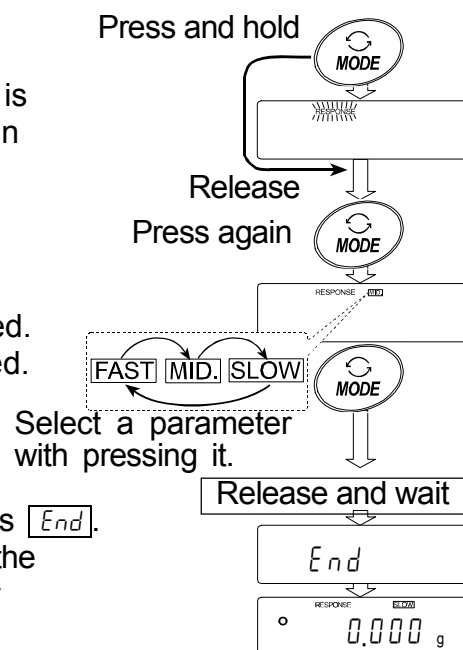

Note

- The weighing speed adjustment can be changed at "Condition ([Cond])" of "Environment, Display (bRSFnC)" in the function table. Refer to "10. Function Table" for details.
- To set a refresh rate of 5 times/second when the response rate is [FAST] or 10 times/second when the response rate is [MID.] or [SLOW], change the "Display refresh rate (SPd)" parameter of "Environment, Display (bRSFnC)" in the function table.
- If the weight value is not stabilized due to drafts or vibration when "[Cond 0]" is selected by the automatic response adjustment, change the parameter of "[Cond]" manually in the function table.

7-2. Self Check Function with Response Adjustment

This function automatically updates the response adjustment by analyzing the influence of the environment on the weighing data and also self-checks the balance performance using the internal mass.

Step 1 Press and hold the **MODE** key until **RESPONSE** is displayed, and then release the key.

Step 2 The balance automatically starts to check the balance performance and sets the response characteristic.

Caution Do not allow vibration or drafts to affect the balance during adjustment.

Step 3 After automatic adjustment, the balance displays the updated response indicator and returns to the weighing mode. The response indicator remains displayed for a while.

Example of display

MID and **OK** : The example above indicates that the result of the self check is good and MID. is selected as the response rate..

Note

- If improper performance is found in the self check, the balance displays **[EH n0]**. Contact the local A&D dealer for repair.
- If the automatic response adjustment fails, the balance displays **[EH nG]**. Check the ambient conditions such as breeze and vibration, also check the weighing pan. Then, perform the adjustment again. To return to the weighing mode, press the **CAL** key.

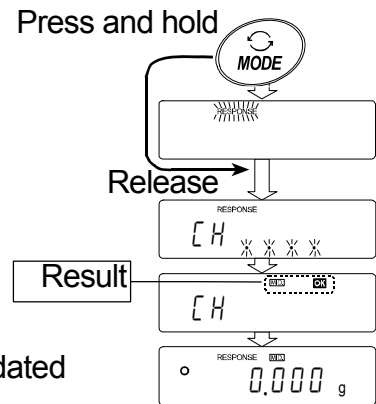

8. Calibration

8-1. Calibration Group

The balance has the following modes as a calibration group.

Calibration

- Automatic self calibration (Calibration due to changes in temperature)
- Calibration using the internal mass (One-touch calibration)
- Calibration using an external weight

Calibration Test

- Calibration test using an external weight (Calibration test does not perform calibration)

Correction of the internal mass value

Terms

The following terms are defined as follows:

- Internal mass = Built-in calibration weight
- External weight = A weight that you have. Referred to as a calibration weight when used for calibration.
- Calibration weight = A weight used for calibration
- Target weight = An external weight used for calibration test

Caution

- Calibration adjusts the balance for accurate weighing.
Besides periodic calibration and before each use, perform calibration when:
 - The balance is installed for the first time.
 - The balance has been moved.
 - The ambient environment has changed.
- Do not allow vibration or drafts to affect the balance during calibration.
- To output the data for GLP using the RS-232C interface, set "GLP output (*info*)" of "Data output (*dout*)". Refer to "10. Function Table". Time and date can be added to the GLP report. If the time or date is not correct, adjust them. Refer to the GX-K series instruction manual "10-7. Clock and Calendar Function".
- Calibration test is available only when "GLP output (*info*)" of "Data output (*dout*)" is set to "1" or "2",
- The calibration and calibration test data can be stored in memory. To store them, set "Data memory (*data*)" to "3". Refer to the GX-K series instruction manual "12. Data Memory" for details.
- The value of the internal mass may change due to aging, corrosion or other damage caused by the operating environment. Check the internal mass periodically. Correct the internal mass value as necessary.

Caution on using an external weight

- The accuracy of an external weight can influence the accuracy of weighing. Select an appropriate weight as listed below:
- Select a mass for calibration and calibration test from the following table.

Model	Usable calibration weight	Adjustable range
MC-10K	2 kg, 3 kg, 4 kg, 5 kg, 6 kg, 7 kg, 8 kg, 9 kg, 10 kg	-0.150 g ~ +0.159 g
MC-30K	20 kg , 30 kg	-1.50 g ~ +1.59 g

The calibration weight in **bold type**: factory setting

The calibration weight value can be adjusted within the range above.

Display



This indicator means "In process of measuring calibration data". Do not allow vibration or drafts to affect the balance while the indicator is displayed.

8-2. Automatic Self Calibration

Automatic self calibration due to changes in temperature

This function automatically calibrates the balance when the balance detects an ambient temperature change. If GLP output is selected in the function table, the balance outputs the calibration report or stores the data in memory. Automatic self calibration functions even if the display is turned off (standby state). Refer to "9-1. Permit Or Inhibit" for the operation.

Caution

- **If something is on the weighing pan, the balance judges that it is in use and does not perform automatic self calibration. To maintain the calibrated state, keep the weighing pan clear while not in use.**



Indicates that the balance detects a change in ambient temperature and automatic self calibration will start. If the balance is not used for a few minutes with this indicator blinking, the balance performs automatic self calibration. The blinking duration depends on the environment.

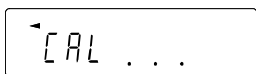

Indicates that the balance is measuring calibration data. Do not allow vibration or drafts to affect the balance while this indicator is displayed. After calibration, the balance returns to indicate the previous display.

- Note** The balance can be used while the indicator blinks. But, it is recommended that to maintain the accuracy, stop using the balance and confirm that there is nothing on the pan and allow the balance to perform self calibration.

8-3. One-Touch Calibration

Calibration using the internal mass

This function calibrates the balance using the internal mass. The only operation required is to press the **CAL** key.

- Step 1 Connect the AC adapter and warm up the balance for at least 30 minutes with nothing on the weighing pan.
- Step 2 Press the **CAL** key.
- Step 3 The balance displays **CRd** and performs calibration using the internal mass. Do not allow vibration or drafts to affect the balance.
- Step 4 The balance displays **End** after calibration. If the "GLP output (inF0)" parameter of the function table is set to "1" or "2", the balance displays **GLP** and outputs the "calibration report" using the RS-232C interface or stores the data in memory. Refer to "11-2. GLP Report" and "Data memory (dRR)" of the function table for details.
- Step 5 The balance will automatically return to the weighing mode after calibration.

About the internal mass

The value of the internal mass may change due to aging, corrosion or other damage caused by the operating environment. Check the internal mass periodically. Correct the internal mass value as necessary. Refer to "8-6. Correcting the Internal Mass Value".

To maintain the weighing accuracy, perform the calibration using an external weight periodically, as described below.

8-4. Calibration Using an External Weight

This function calibrates the balance using an external weight.

When the MC-10K is used

- Step 1 Connect the AC adapter and warm up the balance for at least 30 minutes with nothing on the weighing pan.
- Step 2 Press and hold the **[CAL]** key until **[CALout]** is displayed, then release the key.
- Step 3 The balance displays **[CAL 0]**.
- If you want to change the calibration weight, press the **[SAMPLE]** key and go to step 4.
 - If you use the calibration weight value stored in the balance, go to step 5.
- Step 4 Specify the calibration weight value as follows:
- [SAMPLE]** key... To switch between the calibration weight selection mode (All of the digits blinking) or the value adjustment mode (The selected digits blinking).
- With the MC-10K, the digits in the 1st, 2nd, and 3rd decimal places can be adjusted. With the MC-31K, the digits in the 1st and 2nd decimal places can be adjusted.
- [RE-ZERO]** key... To select the calibration weight (All of the digits blinking) or adjust the value (The selected digits blinking). Refer to page 19.
- [PRINT]** key..... To store the new weight value. Even if the AC adapter is removed, the data is maintained in non-volatile memory.
- [CAL]** key To cancel the operation and return to **[CAL 0]**.
- Step 5 Confirm that there is nothing on the pan and press the **[PRINT]** key. The balance measures the zero point. Do not allow vibration or drafts to affect the balance. The balance displays the calibration weight value.
- Step 6 Place the displayed calibration weight on the pan and press the **[PRINT]** key. The balance measures the calibration weight. Do not allow vibration or drafts to affect the balance.
- Step 7 The balance displays **[End]**.
Remove the weight from the pan.
- Step 8 If the "GLP output (*info*)" parameter, of the function table, is set to "i" or "c", the balance displays **[GLP]** and outputs the "Calibration Report" using the RS-232C interface or stores the data in memory. For details on the calibration report format, refer to "11-2. GLP Report".
- Step 9 The balance will automatically return to the weighing mode.
- Step 10 Place the calibration weight on the pan and confirm that the value displayed is within ± 20 digits of the specified value. If it is not within the range, check the ambient conditions such as breeze and vibration also check the weighing pan. Then, repeat steps 1 to 10.

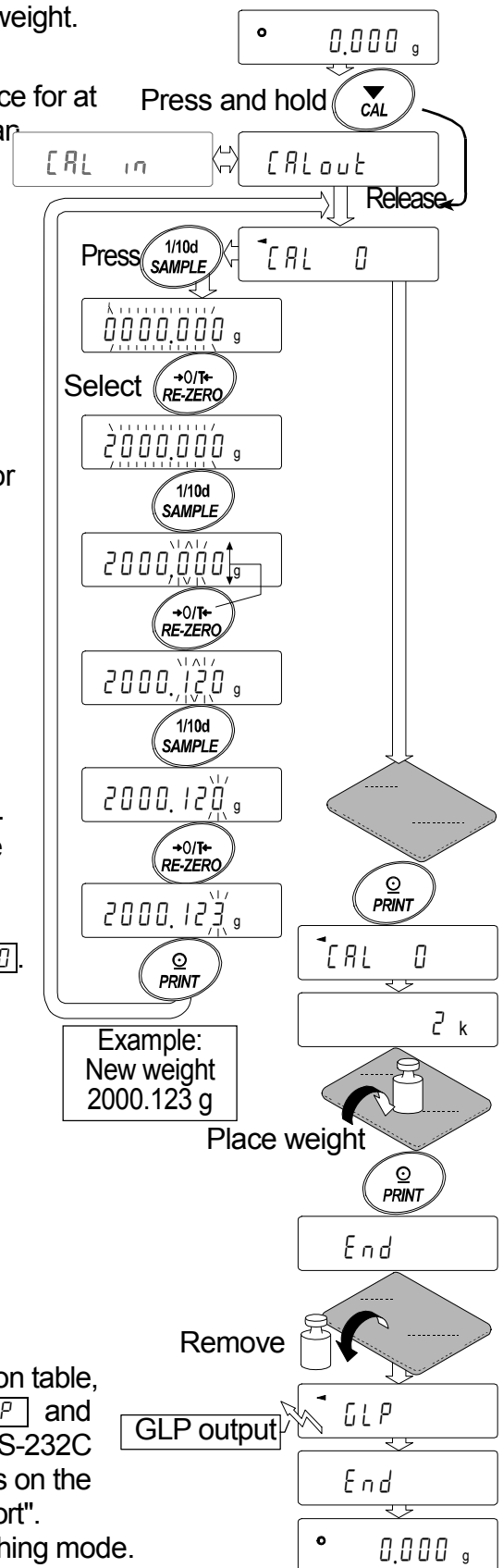

8-5. Calibration Test Using an External Weight

This function tests the weighing accuracy using an external weight and outputs the result. This is available only when the "GLP output (*inf0*)" parameter is set to "1" or "2".
(Calibration test does not perform calibration)

When the MC-10K is used

- Step 1 Connect the AC adapter and warm up the balance for at least 30 minutes with nothing on the weighing pan.
- Step 2 Press and hold the **CAL** key until **CC out** is displayed, then release the key.
- Step 3 The balance displays **CC 0**.
- If you want to change the target weight, press the **SAMPLE** key and go to step 4.
A list of usable weights is shown on page 20.
 - If you use the target weight value stored in the balance, go to step 5.
- Step 4 Specify the target weight value as follows:
- SAMPLE** key... To switch between the target weight selection mode (All of the digits blinking) or the value adjustment mode (The selected digits blinking).
- With the MC-10K, the digits in the 1st, 2nd, and 3rd decimal places can be adjusted.
With the MC-31K, the digits in the 1st and 2nd decimal places can be adjusted.
- RE-ZERO** key... To select the target weight (All of the digits blinking) or adjust the value (The selected digits blinking). Refer to page 19.
- PRINT** key..... To store the new weight value. Even if the AC adapter is removed, the data is maintained in non-volatile memory.
- CAL** key..... To cancel the operation and return to **CC 0**.
- Step 5 Confirm that there is nothing on the pan and press the **PRINT** key. The balance measures the zero point and displays the measured value. Do not allow vibration or drafts to affect the balance. The balance displays the target weight value.
- Step 6 Place the displayed target weight on the pan and press the **PRINT** key. The balance measures the target weight and displays the measured value. Do not allow vibration or drafts to affect the balance.
- Step 7 The balance displays **End**.
Remove the weight from the pan.
- Step 8 The balance displays **GLP** and outputs the "calibration test report" using the RS-232C interface or stores the calibration test data in memory. Refer to "11-2. GLP Report" of the function table for details.
- Step 9 The balance will automatically return to the weighing mode.

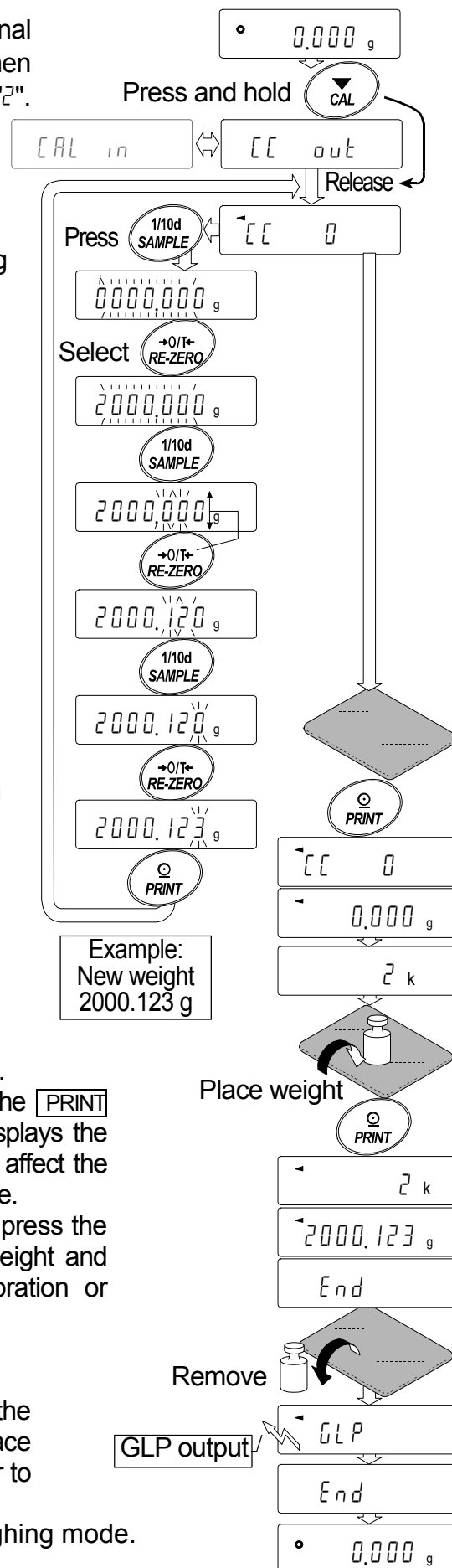

8-6. Correcting the Internal Mass Value

The balance can correct the internal mass value within the range shown below. This function corrects the internal mass value to conform to an external weight. The corrected mass value is maintained in non-volatile memory even if the AC adapter is removed. The internal mass value is corrected as follows:

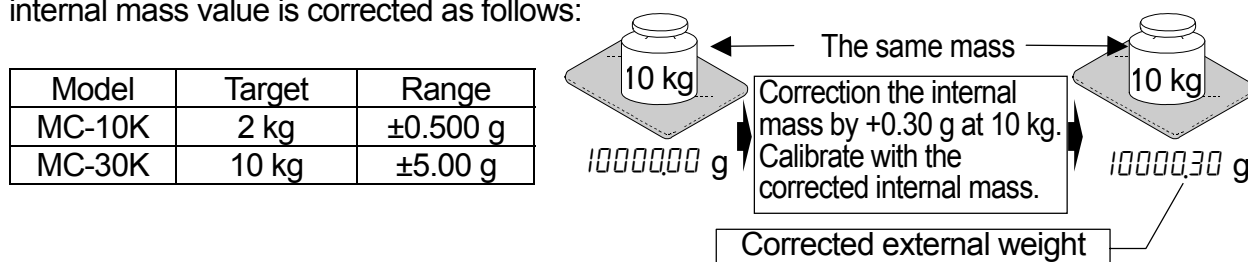

Step 1 Calibrate the balance using the internal mass. (one-touch calibration).

Place the external weight and find out the correction value.

Example for correcting the weight value by +0.30 g in 10 kg, when using MC-30K. If correcting the weight value by +0.30 g in 5 kg, the weight changed into 10 kg, the correction value is +0.60 g.

Step 2 Press the **ON:OFF** key to turn off the display.

Step 3 While pressing and holding the **PRINT** key and the **SAMPLE** key, press the **ON:OFF** key. The balance displays **P5**.

Step 4 Press the **PRINT** key. Then the balance displays the function switches. Set the function table switch and internal mass correction switch to "I" as shown above using the following keys. **SAMPLE** key... To select the switch to change the value.

The selected digit blinks.

RE-ZERO key... To change the parameter of the switch selected.

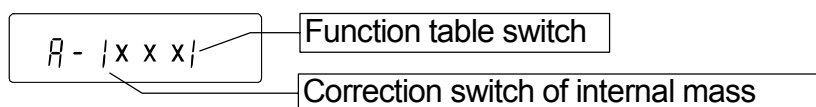

Step 5 Press the **PRINT** key to store the new setting. The balance returns to the weighing mode.

Step 6 Press and hold the **SAMPLE** key to enter the function table and release the key when **bA5FnC** is displayed.

Step 7 Press the **SAMPLE** key several times until **[5 in]** is displayed, then release the key.

Step 8 Press the **PRINT** key to enter the procedure for correcting the internal mass value.

Step 9 Correct the internal mass value using the following keys. **RE-ZERO** key... To select the value. (-500 digits appear after +500 digits)

PRINT key... To store the new value and display the next menu item of the function table.

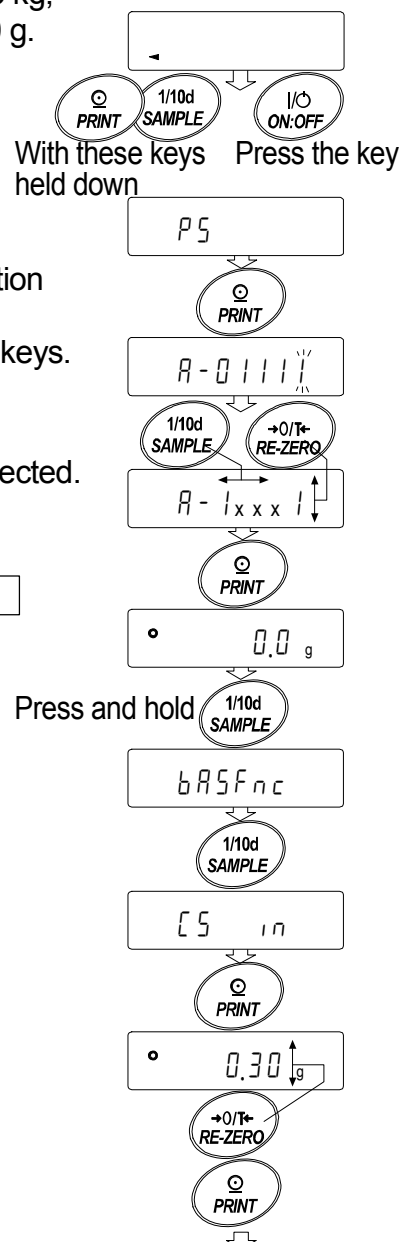

CAL keyTo cancel the correction and display the next menu item of the function table.

Step 10 Press the **CAL** key to return the weighing mode.

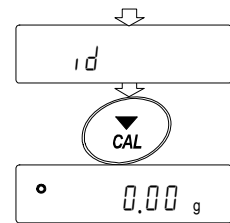

Step 11 Press the **CAL** key to calibrate the balance using the internal mass.

Step 12 Place the external weight on the pan and confirm that the correction has been performed properly. In this example, confirm that the value displayed is within the range that is described at "Accuracy after calibration using the internal mass" of "17. Specifications". If the value is incorrect, repeat the correction.

9. Function Switch And Initialization

9-1. Permit or Inhibit

The balance stores parameters that must not be changed unintentionally (Example: Calibration data for accurate weighing, Data for adapting to the operating environment, Control data for the RS-232C interface). There are five switches for the purpose of protecting parameters. Each switch can select either "permit" or "inhibit". The "inhibit" protects parameters against unintentional operations.

Step 1 Press the **ON:OFF** key to turn off the display.

Step 2 While pressing and holding the **PRINT** key and the **SAMPLE** key, press the **ON:OFF** key to display **P5**.

Step 3 Press the **PRINT** key. Then the balance displays the function switches.

Step 4 Set the switches using the following keys.

- | | |
|--------------------|---|
| SAMPLE key | To select a switch to change the parameter. The selected switch blinks. |
| RE-ZERO key | To change the parameter of the switch selected. |
| | □ To inhibit changes. (Can not be used.) |
| | ! To permit changes. (Can be used.) |
| PRINT key | To store the new parameter and return to the weighing mode. |
| CAL key | To cancel the operation and return to the weighing mode. |

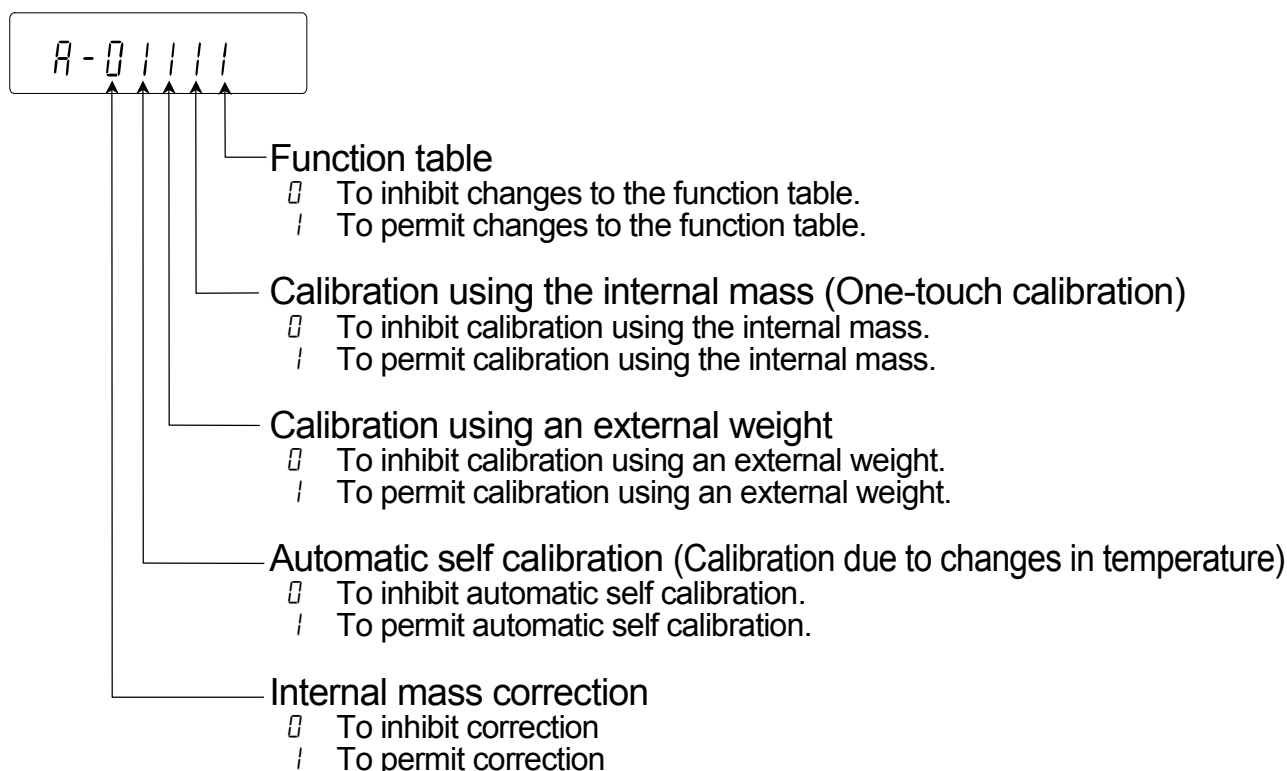

9-2. Initializing the Balance

This function returns the following parameters to factory settings.

- Calibration data
- Function table
- The sample unit mass value (counting mode),
100% reference mass value (percent mode)
- The data that is stored in the balance using the data memory function
- External calibration weight and target weight value
- Function switch settings

Note Be sure to calibrate the balance after initialization.

Step 1 Press the **ON:OFF** key to turn off the display.

Step 2 While pressing and holding the **PRINT** key and the **SAMPLE** key, press the **ON:OFF** key to display **P5**.

Step 3 Press the **SAMPLE** key to display **[Lr]**.

Step 4 Press the **PRINT** key.
To cancel this operation, press the **CAL** key.

Step 5 Press the **RE-ZERO** key to display **[Lr 00]**.

Step 6 Press the **PRINT** key to initialize the balance.
The balance will automatically return to the weighing mode.

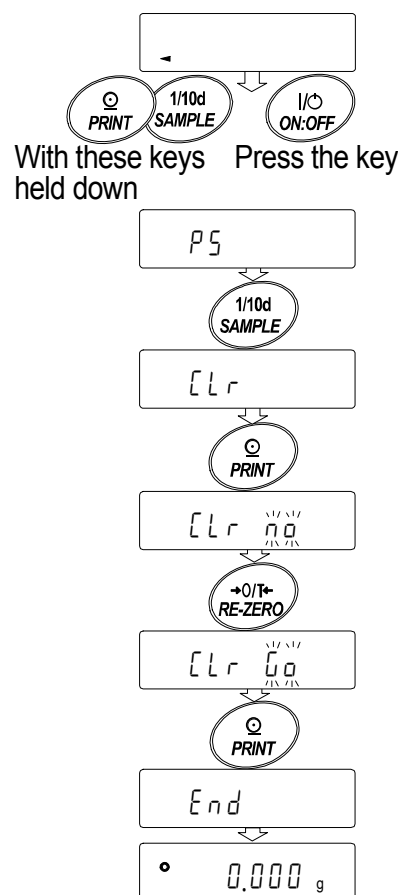

10. Function Table

This function table reads or rewrites the parameters that are stored in the balance. These parameters are maintained in non-volatile memory, even if the AC adapter is removed.

10-1. Structure and Sequence of the Function Table

This function table menu consists of two layers. The first layer is the "Class" and the second layer is the "Item". It has effect that a parameter is stored in each item and is displayed latest. New parameters are applied to the balance after the **PRINT** key is pressed.

Example

This example sets "Stores weighing data" for "Data memory" and "1 minute" for "Interval time".

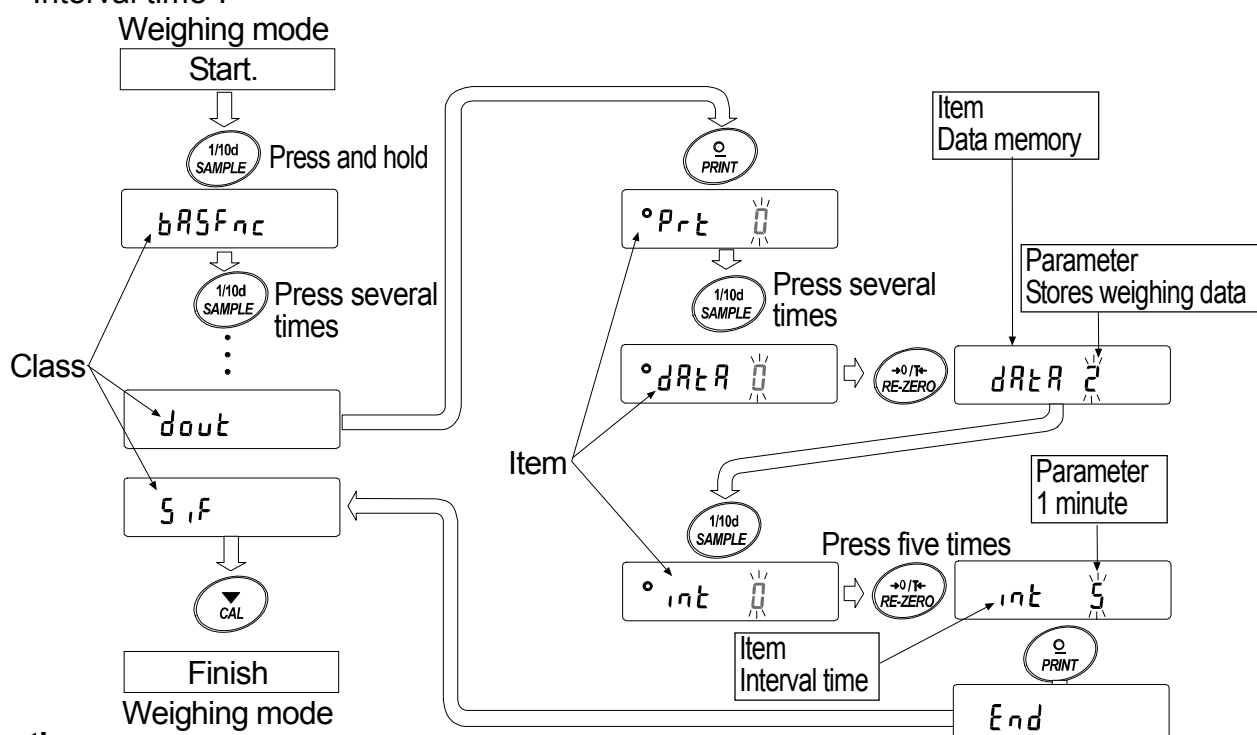

Caution

Check the settings and condition before changing parameters.

10-2. Display and Operation Keys

	The symbol "O" shows effective parameter.
	When pressed and held in the weighing mode, enters the function table mode. Selects the class or item in the function table mode.
	Changes the parameter.
	When a class is displayed, moves to an item in the class. When an item is displayed, stores the new parameter and displays the next class.
	When an item is displayed, cancels the new parameter and displays the next class. When a class is displayed, exits the function table mode and returns to the weighing mode.

10-3. Details of the Function Table

Class	Item and Parameter	Description										
bRSFnC Environment Display	Cond Condition	<table border="0"> <tr> <td>0</td> <td>Fast response, sensitive value</td> <td>FAST</td> </tr> <tr> <td>1</td> <td></td> <td>MID</td> </tr> <tr> <td>2</td> <td>Slow response, stable value</td> <td>SLOW</td> </tr> </table>	0	Fast response, sensitive value	FAST	1		MID	2	Slow response, stable value	SLOW	
	0	Fast response, sensitive value	FAST									
	1		MID									
	2	Slow response, stable value	SLOW									
	St-b Stability band width	<table border="0"> <tr> <td>0</td> <td>Stable when within ± 1 digit</td> </tr> <tr> <td>1</td> <td></td> </tr> <tr> <td>2</td> <td>Stable when within ± 3 digits</td> </tr> </table>	0	Stable when within ± 1 digit	1		2	Stable when within ± 3 digits	The stabilization indicator illuminates with the display fluctuation within the range. With "Hold 1", sets the stable range.			
	0	Stable when within ± 1 digit										
	1											
	2	Stable when within ± 3 digits										
	Hold Hold function	<table border="0"> <tr> <td>0</td> <td>OFF</td> </tr> <tr> <td>1</td> <td>ON</td> </tr> </table>	0	OFF	1	ON	Holds the display when stable in animal mode. With "Hold 1", ANIMAL turns on.					
	0	OFF										
	1	ON										
	trc Zero tracking	<table border="0"> <tr> <td>0</td> <td>OFF</td> </tr> <tr> <td>1</td> <td>Normal</td> </tr> <tr> <td>2</td> <td>Strong</td> </tr> <tr> <td>3</td> <td>Very strong</td> </tr> </table>	0	OFF	1	Normal	2	Strong	3	Very strong	Keeps zero display by tracking zero drift.	
	0	OFF										
	1	Normal										
2	Strong											
3	Very strong											
SPd Display refresh rate	<table border="0"> <tr> <td>0</td> <td>5 times/second</td> </tr> <tr> <td>1</td> <td>10 times/second</td> </tr> </table>	0	5 times/second	1	10 times/second	Period to refresh the display						
0	5 times/second											
1	10 times/second											
Pnt Decimal point	<table border="0"> <tr> <td>0</td> <td>Point (.)</td> </tr> <tr> <td>1</td> <td>Comma (,)</td> </tr> </table>	0	Point (.)	1	Comma (,)	Decimal point format						
0	Point (.)											
1	Comma (,)											
P-on Auto display-ON	<table border="0"> <tr> <td>0</td> <td>OFF</td> </tr> <tr> <td>1</td> <td>ON</td> </tr> </table>	0	OFF	1	ON	Turns on the weighing mode display when the AC adapter is connected.						
0	OFF											
1	ON											
P-off Auto display-OFF	<table border="0"> <tr> <td>0</td> <td>OFF</td> </tr> <tr> <td>1</td> <td>ON (10 minutes)</td> </tr> </table>	0	OFF	1	ON (10 minutes)	Turns off the display after 10 minutes of inactivity.						
0	OFF											
1	ON (10 minutes)											
CS1 Capacity indicator	<table border="0"> <tr> <td>0</td> <td>OFF</td> </tr> <tr> <td>1</td> <td>ON</td> </tr> </table>	0	OFF	1	ON	Capacity indicator. Zero: 0% Maximum capacity: 100%						
0	OFF											
1	ON											
Rdd Accumulation function	<table border="0"> <tr> <td>0</td> <td>OFF</td> </tr> <tr> <td>1</td> <td>ON</td> </tr> </table>	0	OFF	1	ON	Displays and outputs the total value of the weighing data.						
0	OFF											
1	ON											
rnG Display at start	<table border="0"> <tr> <td>0</td> <td>Does not display</td> </tr> <tr> <td>1</td> <td>Displays</td> </tr> </table>	0	Does not display	1	Displays	Select whether or not to display the smallest displayable weighing value at weighing start.						
0	Does not display											
1	Displays											
Fl Filter	<table border="0"> <tr> <td>0</td> <td>Not used</td> </tr> <tr> <td>1</td> <td>Used (when the balance is used as a mass comparator)</td> </tr> </table>	0	Not used	1	Used (when the balance is used as a mass comparator)							
0	Not used											
1	Used (when the balance is used as a mass comparator)											
P-tr Zero upon power-on	<table border="0"> <tr> <td>0</td> <td>Sets the display to zero.</td> </tr> <tr> <td>1</td> <td>Does not set the display to zero. Displays the previous value. With this setting, do not perform re-zero operations frequently. Refer to "Zero upon power-on" on page 32.</td> </tr> </table>	0	Sets the display to zero.	1	Does not set the display to zero. Displays the previous value. With this setting, do not perform re-zero operations frequently. Refer to "Zero upon power-on" on page 32.							
0	Sets the display to zero.											
1	Does not set the display to zero. Displays the previous value. With this setting, do not perform re-zero operations frequently. Refer to "Zero upon power-on" on page 32.											
SPn Span calibration	<table border="0"> <tr> <td>0</td> <td>Performs zero and span calibration</td> </tr> <tr> <td>1</td> <td>Performs span calibration only. Span calibration using the internal mass is possible with a tare on the weighing pan. Refer to "Span calibration" on page 32.</td> </tr> </table>	0	Performs zero and span calibration	1	Performs span calibration only. Span calibration using the internal mass is possible with a tare on the weighing pan. Refer to "Span calibration" on page 32.							
0	Performs zero and span calibration											
1	Performs span calibration only. Span calibration using the internal mass is possible with a tare on the weighing pan. Refer to "Span calibration" on page 32.											
CL Add Clock	Refer to the GX-K manual "10-7. Clock and Calendar Function"	Confirms and sets the time and date. The time and date are added to the output data.										
CP FnC Comparator	CP Comparator mode	<table border="0"> <tr> <td>0</td> <td>No comparison</td> </tr> <tr> <td>1</td> <td>Comparison, excluding "near zero" when stable value or overloaded</td> </tr> <tr> <td>2</td> <td>Comparison, including "near zero" when stable value or overloaded</td> </tr> <tr> <td>3</td> <td>Continuous comparison, excluding "near zero"</td> </tr> <tr> <td>4</td> <td>Continuous comparison, including "near zero"</td> </tr> </table>	0	No comparison	1	Comparison, excluding "near zero" when stable value or overloaded	2	Comparison, including "near zero" when stable value or overloaded	3	Continuous comparison, excluding "near zero"	4	Continuous comparison, including "near zero"
	0	No comparison										
	1	Comparison, excluding "near zero" when stable value or overloaded										
2	Comparison, including "near zero" when stable value or overloaded											
3	Continuous comparison, excluding "near zero"											
4	Continuous comparison, including "near zero"											
CP in Data input method	<table border="0"> <tr> <td>0</td> <td>Set the upper lower limit value</td> <td>Select CP Hi or CP Lo.</td> </tr> <tr> <td>1</td> <td>Set the reference value</td> <td>Select CP rEF or CP Lnt.</td> </tr> </table>	0	Set the upper lower limit value	Select CP Hi or CP Lo.	1	Set the reference value	Select CP rEF or CP Lnt.					
0	Set the upper lower limit value	Select CP Hi or CP Lo.										
1	Set the reference value	Select CP rEF or CP Lnt.										
CP-r Comparison results	<table border="0"> <tr> <td>0</td> <td>Not added</td> <td>Select whether or not to add the comparison results to the output data.</td> </tr> <tr> <td>1</td> <td>Added</td> <td></td> </tr> </table>	0	Not added	Select whether or not to add the comparison results to the output data.	1	Added						
0	Not added	Select whether or not to add the comparison results to the output data.										
1	Added											





▪ : Factory settings. Digit is a unit of minimum weighing value.

Class	Item and Parameter	Description	
$[P_{FnC}]$ Comparator Displayed only when Comparator output (GX-04K) is installed	$[P_{-b}]$ Main display comparison	0 OFF 1 ON	Displays the results on the main portion of the display in place of the weight value.
	bEP_{-} LO buzzer	0 OFF 1 ON	Select whether or not to sound the LO buzzer.
	bEP_{-} OK buzzer	0 OFF 1 ON	Select whether or not to sound the OK buzzer.
	bEP_{-} HI buzzer	0 OFF 1 ON	Select whether or not to sound the HI buzzer.
$[P_{Hi}]$ Upper limit		Refer to the GX-K manual "10-8. Comparator Function"	Displayed when $[P_{in0}]$ is selected.
$[P_{Lo}]$ Lower limit			
$[P_{rEF}]$ Reference value		Refer to the GX-K manual "10-8. Comparator Function"	Displayed when $[P_{in1}]$ is selected.
$[P_{Lnt}]$ Tolerance			
$dout$ Data output	Prt Data output mode	0 Key mode	Accepts the [PRINT] key only when the display is stable.
		1 Auto print mode A (Reference = zero)	Outputs data when the display is stable and conditions of $RP-P$, $RP-b$ and the reference value are met.
		2 Auto print mode B (Reference = last stable value)	
	$RP-P$ Auto print polarity	0 Plus only	Displayed value > Reference
		1 Minus only	Displayed value < Reference
		2 Both	Regardless of displayed value
	$RP-b$ Auto print difference	0 10 digits	Difference between reference value and displayed value
		1 100 digits	
		2 1000 digits	
	$dARA$ Data memory	0 Not used	Related items: Prt , int , $d-no$, $S-td$, $info$
		1 Stores unit mass in counting mode	
		2 Stores weighing data	
		3 Stores calibration data	
4 Stores comparator settings			
int Interval time	0 Every measurement	Interval time in the interval memory mode when using Prt 3, $dARA$ 2	
	1 2 seconds		
	2 5 seconds		
	3 10 seconds		
	4 30 seconds		
	5 1 minute		
	6 2 minute		
	7 5 minute		
8 10 minute			

▪ : Factory settings. Digit is a unit of minimum weighing value.

Class	Item and Parameter	Description		
dout Data output	d-no Data number output	<ul style="list-style-type: none"> ▪ 0 No output 1 Output 	Refer to the GX-K manual "12. Data Memory"	
	S-t-d Time/Date output	<ul style="list-style-type: none"> ▪ 0 No output 1 Time only 2 Date only 3 Time and date 	Selects whether or not the time or date is added to the weighing data. Refer to the GX-K manual "10-7. Clock and Calendar Function" for details.	
	S-id ID number output	<ul style="list-style-type: none"> ▪ 0 No output 1 Output 	Selects whether or not the ID number is output.	
	PUSE Data output pause	<ul style="list-style-type: none"> ▪ 0 No pause 1 Pause (1.6 seconds) 	Selects the data output interval.	
	At-F Auto feed	<ul style="list-style-type: none"> ▪ 0 Not used 1 Used 	Selects whether or not automatic feed is performed.	
	info GLP output	<ul style="list-style-type: none"> ▪ 0 No output 1 AD-8121 format 2 General data format 	Selects GLP output method. For how to set time and date to be added, refer to the GX-K manual "10-7. Clock and Calendar Function".	
	Pr-d Zero after output	<ul style="list-style-type: none"> ▪ 0 Not used 1 Used 	Adjusts zero automatically after data is output	
SIF Serial interface	bPS Baud rate	0	600 bps	
		1	1200 bps	
		▪ 2	2400 bps	
		3	4800 bps	
		4	9600 bps	
	btPr Data bit, parity bit	0	7 bits, even	
		1	7 bits, odd	
		2	8 bits, none	
CrLF Terminator	<ul style="list-style-type: none"> ▪ 0 CR LF 1 CR 	CR: ASCII code 0Dh LF: ASCII code 0Ah		
tYPE Data format	<ul style="list-style-type: none"> ▪ 0 A&D standard format 1 DP format 2 KF format 3 MT format 4 NU format 5 CSV format 	Refer to "10-6. Description of the Item "Data Format"".		
	t-UP Timeout	<ul style="list-style-type: none"> 0 No limit ▪ 1 1 second 	Selects the wait time to receive a command.	
	ErEd AK, Error code	<ul style="list-style-type: none"> ▪ 0 No output 1 Output 	AK: ASCII code 06h	
	ctS CTS, RTS control	<ul style="list-style-type: none"> ▪ 0 Not used 1 Used 	Controls CTS and RTS.	
	nLt Programmable-unit (Multi-unit)	Available only when programmable-unit mode is selected. Refer to the GX-K manual "14. Programmable Units" for details.		

▪ : Factory settings. Digit is a unit of minimum weighing value.

Class	Item and Parameter	Description
<i>Unit</i> Unit		Refer to "5. Weighing Units".
<i>ES in</i> Internal mass correction		Displayed only when the internal mass value correction switch is set to 1. Refer to "8. Calibration".
<i>id</i> ID number setting		Refer to "11. ID Number And GLP Report".
<i>ErFnc</i> Extended function	<i>F1-b</i> Averaging range for the first moving average	0 Small
		1 
		2
		3
		4 
	5 Large	
	<i>F1-t</i> Averaging time for the first moving average	0 No averaging
		1 0.5 second
		2 1.0 second
		3 1.5 seconds
		4 2.0 seconds
		5 2.5 seconds
	6 3.2 seconds	
	<i>F2-b</i> Averaging range for the second moving average	0 Small
		1 
		2
3		
4 		
5 Large		
<i>F2-t</i> Averaging time for the second moving average	0 No averaging	
	1 0.5 second	
	2 1.0 second	
	3 1.5 seconds	
	4 2.0 seconds	
	5 2.5 seconds	
6 3.2 seconds		

▪ : Factory settings. Digit is a unit of minimum weighing value.

Caution

The balance may not transmit the data completely at the specified refresh rate, depending on the baud rate or data added to the weighing data such as time, date and ID number.

10-4. Description of the Class "Environment, Display"

Condition ($Cond$)

$Cond \ 0$



$Cond \ 2$

This parameter is for sensitive response to the fluctuation of a weight value. Used for powder target weighing, weighing a very light sample or when quick response weighing is required. After setting, the balance displays **FAST**.

This parameter is for stable weighing with slow response. Used to prevent a weight value from drifting due to vibration or drafts. After setting, the balance displays **SLOW**.

Notes In automatic response adjustment, the weighing speed is selected automatically.

With "Hold function ($Hold$)" set to "ON (1)", this item is used to set the averaging time.

Stability band width ($St-b$)

This item controls the width to regard a weight value as a stable value. When the fluctuation per second is less than the parameter, the balance displays the stabilization indicator and outputs or stores the data. The parameter influences the "Auto print mode"

$St-b \ 0$



$St-b \ 2$

This parameter is used for sensitive response of the stabilization indicator. Used for exact weighing.

This parameter ignores slight fluctuation of a weight value. Used to prevent a weight value from drifting due to vibration or drafts.

Note With "Hold function ($Hold$)" set to "ON (1)", this item is used to set the stabilization range.

Zero upon power-on ($P-tr$)

When a hopper is attached to the weighing pan and loss-in weighing is performed, the remaining amount of the material will become unknown if tare is performed each time a weighing starts.

When " $P-tr$ " is set to "1", tare is not performed at weighing start. So, the remaining amount of the material can be monitored, when the power is turned on again after it was turned off.

Span calibration (SP_n)

When a hopper is attached to the weighing pan and calibration is to be performed with the hopper attached, set " SP_n " to "1". When the tare value (hopper and other devices attached) is within the value in the table below, calibration using the internal mass is possible.

Model	Tare value
MC-10K	9 kg or less
MC-30K	29 kg or less

10-5. Description of the Item "Data Output Mode"

The parameter setting of "Data output mode (*Pr_t*)" applies to the performance when the "Data memory (*dR_tR*)" parameter is set to "2" (to store the weighing data) and when the data is transmitted using the RS-232C interface.

Key mode

When the PRINT key is pressed with the stabilization indicator turned on, the balance outputs or stores the weighing data and the display blinks one time.

Required setting *dout* *Pr_t* 0 Key mode

Auto print modes A and B

When the displayed value is stable and the conditions of "Auto print polarity", "Auto print difference" and reference value are met, the balance outputs or stores the weighing data.

When the PRINT key is pressed with the stabilization indicator turned on, the balance outputs or stores the data and the display blinks one time.

Auto print modes A

Example "For weighing each time a sample is added (or removed), with "*R_r-d*" set to "1" (to adjust zero after the data is output)."

Required setting	<i>dout</i> <i>Pr_t</i> 1	Auto print mode A (reference = zero)
	<i>dout</i> <i>AP-P</i>	Auto print polarity
	<i>dout</i> <i>AP-b</i>	Auto print difference
	<i>dout</i> <i>R_r-d</i> 1	Zero after output

Auto print modes B

Example For weighing while a sample is added.

Required setting	<i>dout</i> <i>Pr_t</i> 2	Auto print mode B (reference = last stable value)
	<i>dout</i> <i>AP-P</i>	Auto print polarity
	<i>dout</i> <i>AP-b</i>	Auto print difference

Stream mode

The balance outputs the weighing data continuously regardless of the display condition. The display does not blink in this mode. The interval memory mode is used when the "Data memory (*dR_tR*)" parameter is set to "2" (to store the weighing data).

Example For monitoring data on a computer.

Required setting	<i>dout</i> <i>Pr_t</i> 3	Stream mode / interval memory mode
	<i>dout</i> <i>dR_tR</i> 0	Data memory function is not used
	<i>bR_SFnc</i> <i>SPd</i>	Display refresh rate
	<i>S_iF</i> <i>bPS</i>	Baud rate

Caution The balance may not transmit the data completely at the specified refresh rate, depending on the baud rate or data added to the weighing data such as time, date and ID number.

Interval memory mode

The weighing data is periodically stored in memory.

Example	For periodical weighing without a personal computer command and to output all of the data, to a computer, at one time.		
	Time and date can be added with "Time/Date output (S-td)".		
Required setting	dout Prt 3	Stream mode / Interval memory mode	
	dout dARR 2	Data memory function is used	
	dout int	Interval time	
Optional setting	dout S-td 1, 2, or 3	Adds the time and date.	

10-6. Description of the Item "Data Format"

A&D standard format S IF TYPE 0

This format is used when the peripheral equipment can receive the A&D format.

If an AD-8121B is used, set the printer to MODE 1 or 2.

- This format consists of fifteen or sixteen characters excluding the terminator.
- With the MC-10K, when the numerical data excluding the decimal point exceeds eight characters, the data format will be sixteen characters long.
- A header of two characters indicates the balance condition.
- The polarity sign is placed before the data with the leading zeros. If the data is zero, the plus sign is applied.
- The unit, consisting of three characters, follows the data.

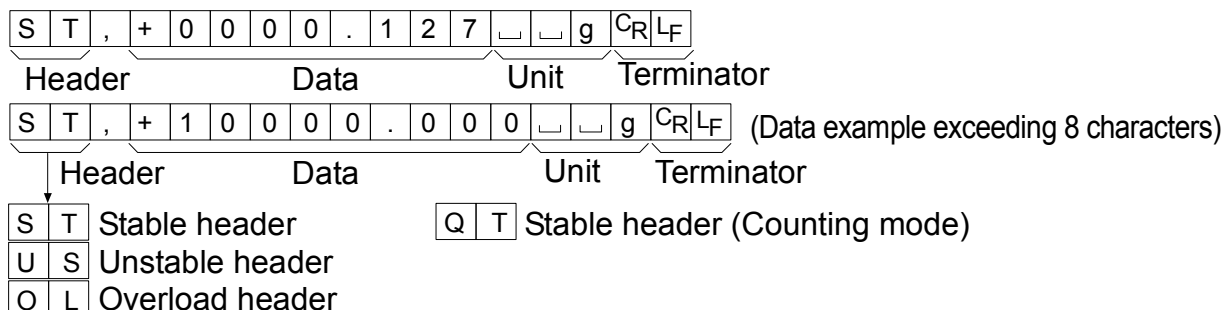

DP (Dump print) format S IF TYPE 1

This format is used when the peripheral equipment can not receive the A&D format.

If an AD-8121B is used, set the printer to MODE 3.

- This format consists of sixteen characters excluding the terminator.
- A header of two characters indicates the balance condition. No overload header is used.
- The polarity sign is placed before the data, with spaces in place of leading zeros, if the data is not zero or overloaded.
- The unit, consisting of three characters, follows the data.

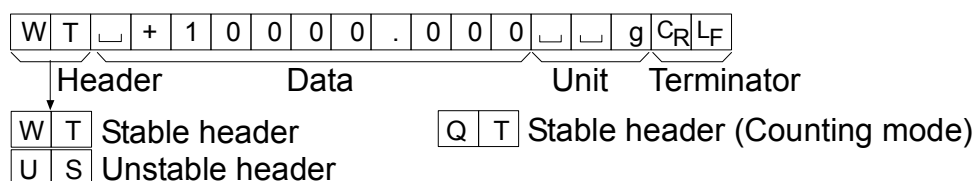

KF format

5 IF TYPE 2

This is the Karl-Fischer moisture meter format and is used when the peripheral equipment can only communicate using this format.

- This format consists of fourteen characters excluding the terminator.
- This format has no header characters.
- The polarity sign is placed before the data, with spaces in place of leading zeros, if the data is not zero or overloaded.
- This format outputs the unit only for a stable value.

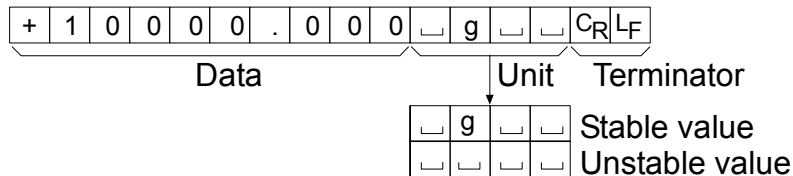

MT format

5 IF TYPE 3

- A header of two characters indicates the balance condition.
- The polarity sign is used only for negative data.
- The weighing data uses spaces in place of the leading zeros.
- The character length of this format changes dependent upon the unit

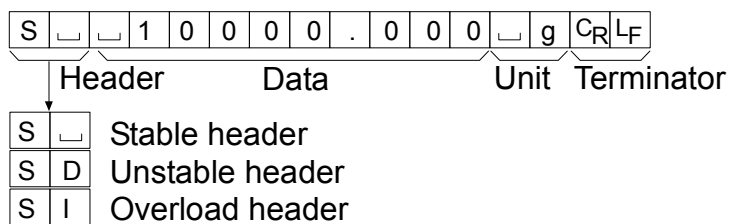

NU (numerical) format

5 IF TYPE 4

This format outputs only numerical data.

- This format consists of nine or ten characters excluding the terminator.
With the MC-10K, when the numerical data excluding the decimal point exceeds eight characters, the data format will be ten characters long.
- The polarity sign is placed before the data with the leading zeros. If the data is zero, the plus sign is used.

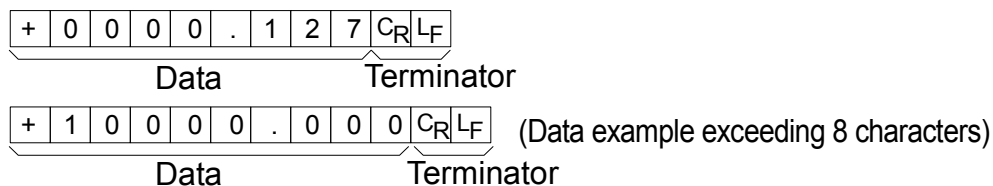

CSV format

5 IF TYPE 5

- This format separates the data of A&D standard format and the unit by a comma (,).
- This format outputs the unit even when the data is overloaded.
- When the ID number, data number, time and date are added at "Data output (*dout*)" of the function table, outputs ID number, data number, date, time and weighing data in this order and separates each item by a comma and treats all the items as one group of data.

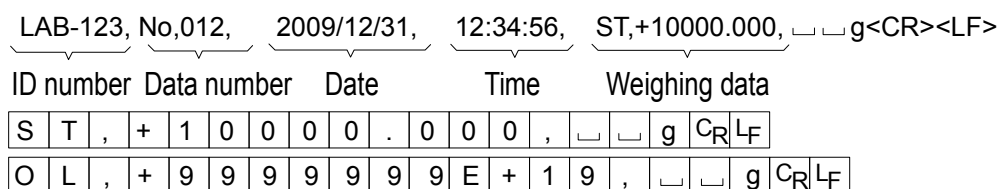

10-6-1. Description of the Data Format Added to the Weighing Data

ID number *dout 5-id 1*

The number to identify a specific balance.

- This format consists of seven characters excluding the terminator.

L	A	B	-	1	2	3	C _R	L _F
---	---	---	---	---	---	---	----------------	----------------

Data number *dout d-no 1*

This format outputs the data number just before the data is transmitted using the RS-232C interface.

- This format consists of six characters excluding the terminator.
- When CSV format (*5-if TYPE 5*) is selected, the period (.) is replaced with a comma (,).

N	o	.	0	0	1	C _R	L _F
---	---	---	---	---	---	----------------	----------------

Data number Terminator

Date *dout 5-td 2 or 3*

- The date output order can be changed in "Clock (*EL Adj*)".
The year is output in a four-digit format.

2	0	0	9	/	1	2	/	3	1	C _R	L _F
---	---	---	---	---	---	---	---	---	---	----------------	----------------

Time *dout 5-td 1 or 3*

- This format outputs time in 24-hour format.

1	2	:	3	4	:	5	6	C _R	L _F
---	---	---	---	---	---	---	---	----------------	----------------

Tare value

- When the tare value in memory is recalled, the tare value is output before the weighing data.

P	T	,	+	0	0	0	1	2	3	.	4	□	□	g	C _R	L _F
---	---	---	---	---	---	---	---	---	---	---	---	---	---	---	----------------	----------------

 Tare value recalled from memory

N	□	,	+	0	0	0	5	6	7	.	8	□	□	g	C _R	L _F
---	---	---	---	---	---	---	---	---	---	---	---	---	---	---	----------------	----------------

 Net value

Comparison results

- By setting "Comparison results (*EP-r*)" of the function table to "I", the comparison results can be added to the data output using the RS-232C serial interface. Use A&D standard format (*TYPE 0*).

The comparison results are added after the header in A&D standard format as below.

S	T	,	O	K	,	+	0	1	2	3	4	5	.	6	□	□	g	C _R	L _F
---	---	---	---	---	---	---	---	---	---	---	---	---	---	---	---	---	---	----------------	----------------

Header Data Unit Terminator

Comparison result

H	I	When the comparison result is HI
O	K	When the comparison result is OK
L	O	When the comparison result is LO
-	-	Not applicable

Note

When the data described above is added to the weighing data, the output is in the following order: ID number, Data number, Date, Time and Weighing data.

10-7. Data Format Examples

Stable

° 12.700 g

(Data example exceeding 8 characters)

° 0000.000 g

A&D	S	T	,	+	0	0	1	2	.	7	0	0	␣	␣	g	C _R	L _F	
DP	W	T	␣	␣	␣	␣	+	1	2	.	7	0	0	␣	␣	g	C _R	L _F
KF	+	␣	␣	␣	1	2	.	7	0	0	␣	g	␣	␣	C _R	L _F		
MT	S	␣	␣	␣	␣	1	2	.	7	0	0	␣	g	C _R	L _F			
NU	+	0	0	1	2	.	7	0	0	C _R	L _F							

A&D	S	T	,	+	1	0	0	0	0	.	0	0	0	␣	␣	g	C _R	L _F
NU	+	1	0	0	0	0	.	0	0	0	C _R	L _F						

Unstable

- 1836.900 g

(Data example exceeding 8 characters)

- 0000.127 g

A&D	U	S	,	-	1	8	3	6	.	9	0	0	␣	␣	g	C _R	L _F	
DP	U	S	␣	␣	-	1	8	3	6	.	9	0	0	␣	␣	g	C _R	L _F
KF	-	␣	1	8	3	6	.	9	0	0	␣	␣	␣	␣	C _R	L _F		
MT	S	D	␣	-	1	8	3	6	.	9	0	0	␣	g	C _R	L _F		
NU	-	1	8	3	6	.	9	0	0	C _R	L _F							

A&D	U	S	,	-	1	0	0	0	0	.	1	2	7	␣	␣	g	C _R	L _F
NU	-	1	0	0	0	0	.	1	2	7	C _R	L _F						

Overload

Positive error

E g

A&D	O	L	,	+	9	9	9	9	9	9	9	E	+	1	9	C _R	L _F
DP	␣	␣	␣	␣	␣	␣	␣	␣	␣	␣	␣	␣	␣	␣	␣	C _R	L _F
KF	␣	␣	␣	␣	␣	␣	H	␣	␣	␣	␣	␣	␣	␣	␣	C _R	L _F
MT	S	I	+	C _R	L _F												
NU	+	9	9	9	9	9	9	9	9	C _R	L _F						

Overload

Negative error

- E g

A&D	O	L	,	-	9	9	9	9	9	9	E	+	1	9	C _R	L _F	
DP	␣	␣	␣	␣	␣	␣	␣	-	E	␣	␣	␣	␣	␣	␣	C _R	L _F
KF	␣	␣	␣	␣	␣	␣	L	␣	␣	␣	␣	␣	␣	␣	␣	C _R	L _F
MT	S	I	-	C _R	L _F												
NU	-	9	9	9	9	9	9	9	9	C _R	L _F						

Unit

g

g

A&D

␣␣g

D.P.

␣␣g

KF

␣g␣␣

MT

␣g

- ␣ Space, ASCII 20h
- L_F Carriage Return, ASCII 0Dh
- C_R Line Feed, ASCII 0Ah

11. ID Number And GLP Report

- The ID number is used to identify the balance when Good Laboratory Practice (GLP) is used.
- The ID number is maintained in non-volatile memory even if the AC adapter is removed.
- The GLP output format is selected at "GLP output (info)" of the function table and can be output to a personal computer or printer using the RS-232C serial interface.
- The GLP output format includes the balance manufacturer, model, serial number, ID number, date, time and space for signature for weighing data, the weight used and results for calibration or calibration test data.
- The balance can output the following reports for GLP.
 - "Calibration report" of the calibration, using the internal mass (Calibration due to changes in temperature and one-touch calibration.)
 - "Calibration report" of the calibration, using an external weight.
 - "Calibration test report" of the calibration test, using an external weight.
 - "Title block" and "End block" for the weighing data.
- Calibration and calibration test data can be stored in memory to output several reports at the same time. Refer to the GX-K series instruction manual "12. Data Memory" for details.
- For details on confirming and setting the time and date, refer to the GX-K series instruction manual "10-7. Clock and Calendar Function".

11-1. Setting the ID Number

- Step 1 Press and hold the **SAMPLE** key until **bR5FnC** of the function table is displayed, then release the key.
- Step 2 Press the **SAMPLE** key several times to display **id**.
- Step 3 Press the **PRINT** key. Set the ID number using the following keys.
RE-ZERO key..... To set the character of the digit selected.
 Refer to the display character set shown below.
SAMPLE key..... To select the digit to change the value.
PRINT key..... To store the new ID number and display **bR5FnC**.
CAL key..... To cancel the new ID number and display **bR5FnC**.
- Step 4 With **bR5FnC** displayed, press the **CAL** key to return to the weighing mode.

Display character set

0	1	2	3	4	5	6	7	8	9	-	␣	A	B	C	D	E	F	G	H	I	J	K	L	M	N	O	P	Q	R	S	T	U	V	W	X	Y	Z
0	1	2	3	4	5	6	7	8	9	-	␣	R	b	C	d	E	F	G	H	i	J	K	L	M	N	O	P	Q	r	S	t	U	v	W	X	Y	Z

␣ Space

11-2. GLP Report

Set the following parameters to output the report.

- To print the report, set the "GLP output (*info*)" parameter to "1" and use MODE 3 of the AD-8121B. Refer to "12-2-1. Connection to the AD-8121B Printer" for details on using the printer.
- To output the report to a personal computer using the RS-232C interface, set the "GLP output (*info*)" parameter to "2".
- If the time and date are not correct, set the correct time and date in "Clock (*CL Add*)" of the function table.

Notes

- For operational details about calibration and calibration test, refer to "8. Calibration".

Calibration report using the internal mass

Setting of " *info* 1"

AD-8121 printer format

```

                A & D
MODEL          MC-30K
S/N           01234567
ID            ABCDEFG
DATE          2009/12/31
TIME          12:34:56
CALIBRATED(INT.)
SIGNATURE
-----
    
```

Setting of " *info* 2"

General format

```

                A_&_D<TERM>
MODEL_____MC-30K<TERM>
S/N_____01234567<TERM>
ID_____ABCDEFG<TERM>
DATE<TERM>
_____2009/12/31<TERM>
TIME<TERM>
_____12:34:56<TERM>
CALIBRATED(INT.)<TERM>
SIGNATURE<TERM>
<TERM>
<TERM>
-----<TERM>
<TERM>
<TERM>
    
```

← Manufacturer →
 ← Model →
 ← Serial number →
 ← ID number →
 ← Date →
 ← Time →
 ← Calibration type →
 ← Signature →

␣ Space, ASCII 20h
 <TERM> Terminator, CR , LF or CR
 CR Carriage return, ASCII 0Dh
 LF Line feed, ASCII 0Ah

Calibration report using an external weight

Setting of " *inf0 1*"

AD-8121 printer format

```

      A & D
MODEL      MC-30K
S/N        01234567
ID         ABCDEFG
DATE       2009/12/31
TIME       12:34:56
CALIBRATED(EXT.)
CAL.WEIGHT
      +20000.00  g
SIGNATURE
-----
  
```

Manufacturer

Model

Serial number

ID number

Date

Time

Calibration type

Calibration weight

Signature

Setting of " *inf0 2*"

General format

```

.....A_&_D<TERM>
MODEL.....MC-30K<TERM>
S/N.....01234567<TERM>
ID.....ABCDEFG<TERM>
DATE<TERM>
.....2009/12/31<TERM>
TIME<TERM>
.....12:34:56<TERM>
CALIBRATED(EXT.)<TERM>
CAL.WEIGHT<TERM>
.....+20000.00_g<TERM>
SIGNATURE<TERM>
<TERM>
<TERM>
-----<TERM>
<TERM>
<TERM>
  
```

└ Space, ASCII 20h

<TERM> Terminator, CR , LF or CR

CR Carriage return, ASCII 0Dh

LF Line feed, ASCII 0Ah

Calibration test report using an external weight

Note Calibration test does not perform calibration.

Setting of " *inf0 1*"

AD-8121 printer format

```

      A & D
MODEL      MC-30K
S/N        01234567
ID         ABCDEFG
DATE       2009/12/31
TIME       12:34:56
CAL.TEST(EXT.)
ACTUAL
      0.00  g
      +19999.99  g
TARGET
      +20000.00  g
SIGNATURE
-----
  
```

Manufacturer

Model

Serial number

ID number

Date

Time

Calibration test type

Zero point value

Target weight value

Target weight

Signature

Setting of " *inf0 2*"

General format

```

.....A_&_D<TERM>
MODEL.....MC-30K<TERM>
S/N.....01234567<TERM>
ID.....ABCDEFG<TERM>
DATE<TERM>
.....2009/12/31<TERM>
TIME<TERM>
.....12:34:56<TERM>
CAL.TEST(EXT.)<TERM>
ACTUAL<TERM>
.....0.00_g<TERM>
.....+19999.99_g<TERM>
TARGET<TERM>
.....+20000.00_g<TERM>
SIGNATURE<TERM>
<TERM>
<TERM>
-----<TERM>
<TERM>
<TERM>
  
```

└ Space, ASCII 20h

<TERM> Terminator, CR , LF or CR

CR Carriage return, ASCII 0Dh

LF Line feed, ASCII 0Ah

Title block and end block

When weight values are recorded as GLP data, a "Title block" is inserted at the beginning and an "End block" is inserted at the end of a group of weight values in the GLP report.

Notes

- To output the report to an AD-8121B, use MODE 3 of the AD-8121B.
- If the data memory function is used, the "Title block" and "End block" can not be output.

Operation

- Step 1 With the weighing data displayed, press and hold the **PRINT** key, until **StArt** is displayed, then release the key. The "Title block" is output.
- Step 2 The weighing data is output according to the parameter setting of the data output mode (*PrE*) of the function table.
- Step 3 Press and hold the **PRINT** key until **rEcEnd** is displayed, then release the key. The "End block" is output.

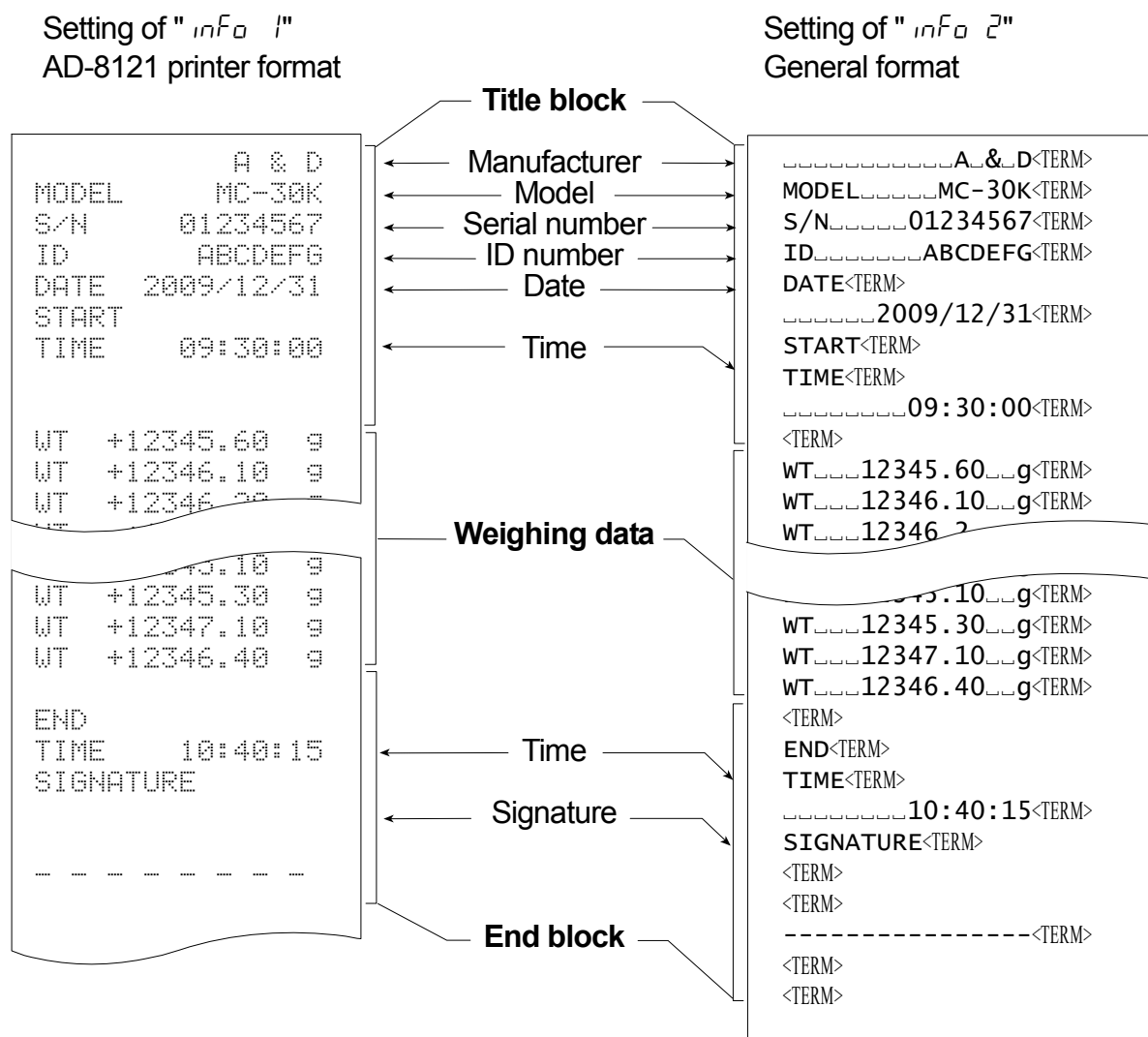

- ┌ Space, ASCII 20h
- <TERM> Terminator, CR, LF or CR
- CR Carriage return, ASCII 0Dh
- LF Line feed, ASCII 0Ah

12. Standard Input And Output Interface

12-1. RS-232C and External Contact Input

D-Sub 25 pin numbers

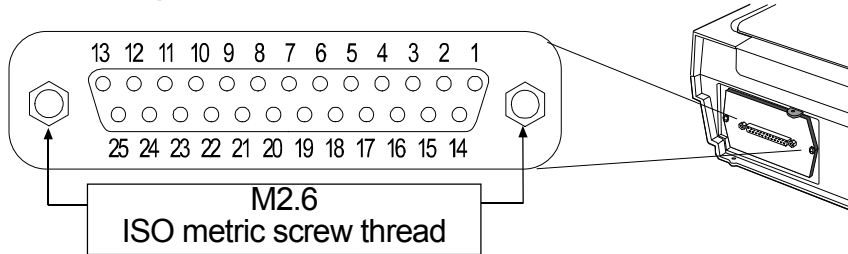

D-Sub 25 pin assignments

Pin No.	Signal name	Interface type	Direction	Description
1	FG		-	Frame ground
2	RXD	RS-232C	Input	Receive data
3	TXD	RS-232C	Output	Transmit data
4	RTS	RS-232C	Input	Ready to send
5	CTS	RS-232C	Output	Clear to send
6	DSR	RS-232C	Output	Data set ready
7	SG	RS-232C / external contact input	-	Signal ground
18	PRINT	External contact input	Input	Same as the PRINT key
19	RE-ZERO	External contact input	Input	Same as the RE-ZERO key
Others	-	-	-	No connection

RS-232C

The balance is a DCE device. Connect the balance to a personal computer (DTE) using a straight through cable.

- Transmission system : EIA RS-232C
- Transmission form : Asynchronous, bi-directional, half duplex
- Transmission rate : 10 times/second or 5 times/second (same as data refresh rate)
- Data format : Baud rate : 600, 1200, 2400, 4800, 9600, 19200bps
- Data bits : 7 or 8 bits
- Parity : Even, Odd (Data bits 7 bits)
- None (Data bits 8 bits)
- Stop bit : 1 bit
- (When sending, 2 bits; receiving, 1 bit.
- A personal computer will function with either setting.)
- Code : ASCII

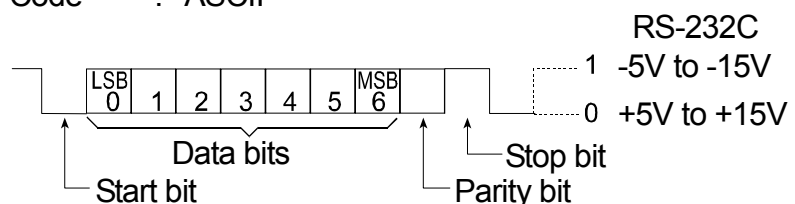

RS-232C Terminals

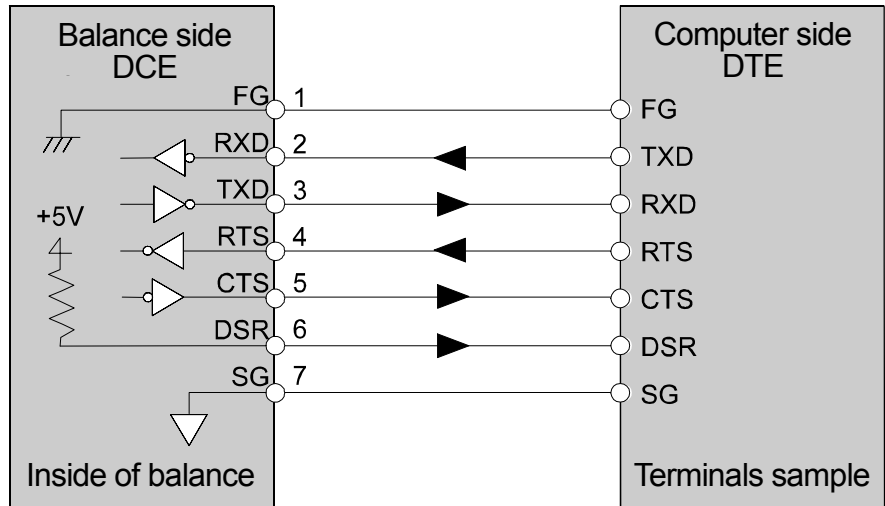

External contact input

By connecting pin 18 (PRINT command) to pin 7, or pin 19 (RE-ZERO command) to pin 7 for 100 ms or more, the same operation as performed by pressing the **PRINT** key or the **RE-ZERO** key, will be performed.

Example of foot switch

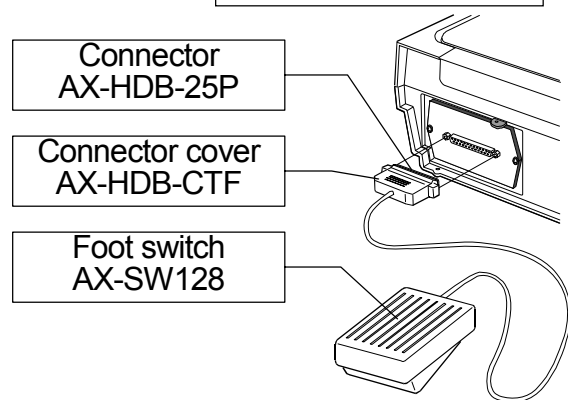

Option

- Connector : AX-HDB-25P/CTF
- Foot switch : AX-SW128

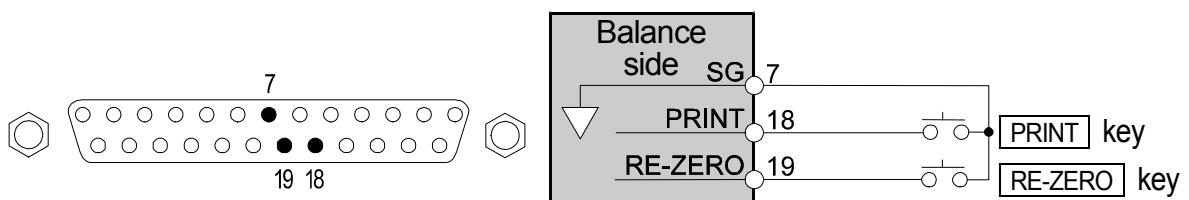

12-2. Connection to Peripheral Equipment

12-2-1. Connection to the AD-8121B Printer

Preset the following parameters to use the AD-8121B printer.

Class	Item and Parameter	Factory settings	AD-8121B MODE 1	AD-8121B MODE 2	AD-8121B MODE 3
Data output	<i>Prt</i> Data output mode	0	0, 1, 2	3	0, 1, 2
	<i>AP-P</i> Auto print polarity	0	#1	Not necessary	#1
	<i>AP-b</i> Auto print difference	0			
	<i>d-no</i> Data number output	0	0	0	0, 1
	<i>S-t-d</i> Time/Date output	0	0	0	0, 1, 2, 3
	<i>S-id</i> ID number output	0	0	0	0, 1
	<i>PAUSE</i> Data output pause	0	0	0	0, 1 #2
	<i>At-F</i> Auto feed	0	0	0	0, 1
Serial interface	<i>bPS</i> Baud rate	2	2	2	2
	<i>bLPr</i> Data bit, parity bit	0	0	0	0
	<i>CrLF</i> Terminator	0	0	0	0
	<i>TYPE</i> Data format	0	0	0	1
	<i>cts</i> CTS, RTS control	0	0	0	0

#1 Set parameters when auto print mode A or B (*Prt* = 1 or 2) is selected.

#2 Set 1 when multiple lines are printed. Example: When appending ID number, set 1.

Settings of AD-8121B

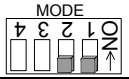
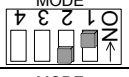
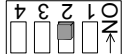
MODE	AD-8121B DIP switch	Description
MODE 1		Print at receiving data. Standard mode, statistic mode
MODE 2		Print by DATA key operation or built-in timer. Standard mode, interval mode, chart mode
MODE 3		Print at receiving data. Dump print mode

DIP switch No.3 : Handling unstable data

- ON Print
- OFF Not printed



DIP switch No.4 : Data input specifications (Interface selection)

- ON Current loop
- OFF RS-232C

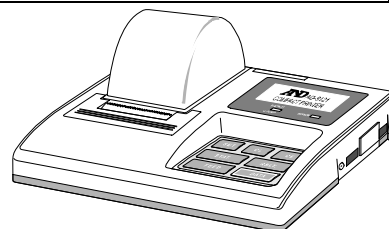
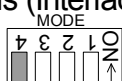

The printer performs as follows, depending on the data memory setting.

Setting	Output data
<i>dRtR</i> 0	The weighing data
<i>dRtR</i> 2	The weighing data stored in memory
<i>dRtR</i> 3	The calibration report stored in memory

Refer to "11-2. GLP Report" for print samples.

12-2-2. Connection to a Computer and the Use of WinCT

The balance is of the DCE type (Data Communication Equipment), which can be connected to a personal computer using the RS-232C interface. Before connection, read the personal computer manual thoroughly. Use a standard DCE cable for connection (cable type: straight-through). When the personal computer type is a DOS/V with a 9-pin port, use a straight-through cable with a 25-pin male connector and a 9-pin female connector.

Using Windows Communication Tools Software (WinCT)

When Windows is used as an operating system in a personal computer, the WinCT software can be used to transmit the weighing data to the personal computer.

The current version of the WinCT can be downloaded from the A&D website.

Check for applicable Windows versions when downloading the software.

For details on WinCT, refer to the WinCT instruction manual which is available on the A&D website.

The WinCT software has two communication methods: "RsCom" and "RsKey".

RsCom

- RsCom can transmit commands to control the balance.
- RsCom can perform bi-directional communication between the balance and a personal computer using the RS-232C interface.
- RsCom can display or store the data using a text file format. RsCom can also print the data using a printer connected to the personal computer.
- When several ports of a personal computer have balances connected, can communicate with each balance simultaneously.
- RsCom can share a personal computer with other application software.
- RsCom can receive the balance GLP report.

RsKey

- RsKey can transmit the weighing data output from the balance directly to other application software such as Microsoft Excel.
- RsKey can be used with most application software.
- RsKey can receive the balance GLP report.

Using the WinCT software, the balance can do the following:

- **Analyzing the weighing data and the statistics with "RsKey"**

The weighing data can be input directly into an Excel worksheet. Then, Excel can analyze the data to obtain total, average, standard deviation, maximum and minimum value, and display them in a graph.
- **Controlling the balance using commands from a personal computer**

By using "RsCom", the personal computer sends commands such as "re-zero" or "send weighing data" to the balance and controls the balance.
- **Printing the balance GLP report using your printer**

The balance GLP report can be printed using a printer connected to the personal computer.
- **Receiving weighing data at a certain interval**

The weighing data can be received at a certain interval and data characteristic with elapsed time can be obtained.
- **Using the balance memory function**

The data can be stored in the balance's memory. Of the data stored, the weighing data and calibration data can be transmitted to a personal computer at one time.
- **Using a personal computer as an external indicator**

With the "RsKey" test mode function, a personal computer can be used as an external weight indicator for the balance. (To do this, set the balance data output mode to stream mode.)

13. Commands

13-1. Command List

Note A command has a terminator added, that is specified using "*SIF* [rLF]" of the function table, and is sent to the balance.

Commands to query weighing data	
C	Cancels the S or SIR command.
Q	Requests the weighing data immediately.
S	Requests the weighing data when stabilized.
SI	Requests the weighing data immediately.
SIR	Requests the weighing data continuously.

Commands to control the balance	
?CN	Requests the upper/lower limit value code number of the selected value.
?HI	Requests the upper limit value.
?ID	Requests the identification number.
?LO	Requests the lower limit value.
?MA	Outputs all weighing data in memory.
?MQnnn	Outputs data with the data number nnn. nnn: Three digits
?MX	Outputs the number of data in memory (the last data number)
?PN	Request the tare number of the selected value.
?PT	Request the tare value.
?SN	Request the serial number of the balance.
?TN	Request the model name of the balance.
?UN	Requests the unit mass numbers in memory.
?UW	Requests the unit mass value.
CAL	Same as the CAL key.
CN:mm	Recalls the upper/lower limit value in memory. mm: 01 to 20.
HI:*****.*_ _g	Sets the upper limit values. _ is space mark. Example: the upper limit value is 2000.0 g. Command: HI:+002000.0_ _g
ID:*****	Sets identification number.
LO:*****.*_ _g	Sets the lower limit values. _ is space mark. Example: the lower limit value is 1000.0 g. Command :LO:+001000.0_ _g
MCL	Deletes all data in memory.
MD:nnn	Deletes data with the data number nnn. nnn: Three digits.
OFF	Turns the display off.
ON	Turns the display on.
P	Same as the ON:OFF key
PN:mm	Recalls the tare value in memory. mm: 01 to 20.
PRT	Same as the PRINT key
PT:*****.*_ _g	Sets the tare value. _ is space mark. Example: the tare value is 1000.0 g. Command :PT:+001000.0_ _g

Commands to control the balance	
R	Same as the RE-ZERO key
SMP	Same as the SAMPLE key.
U	Same as the MODE key
UN: mm	Recalls the unit mass values in memory. mm: 01 to 50.
UW: *****.*_g	Changes the unit mass value. Use "g" of unit. _ is space mark. Example: the unit mass value is 2000.0 g. Command: UW: +002000.0_g

When a unit is required in commands such as a "PT:" command, use the 3-digit unit code of the A&D standard format.

nnn indicates a three-digit numerical value.

13-2. Acknowledge Code and Error Codes

When the "Serial interface function (SIF)" parameter is set to "Enabled", the balance outputs <AK> code or error code to each command as follows:

<AK> (06h) Acknowledge in ASCII code.

- When the balance receives a command to request data and can not process it, the balance transmits an error code (EC, E_{xx}).

When the balance receives a command to request data and can process it, the balance outputs the data.

- When the balance receives a command to control the balance and can not process it, the balance transmits an error code (EC, E_{xx}).

When the balance receives a command to control the balance and can process it, the balance transmits the acknowledge code.

Among commands to control the balance, the following transmit the acknowledge code both when the balance receives the command and when the balance has accomplished the command. If the command can not be processed properly, the balance transmits an error code (EC, E_{xx}). This error can be released using the CAL command.

CAL command (Calibration command using internal mass)

ON command (Display ON command)

P command (Display ON/OFF command)

R command (RE-ZERO command)

R command

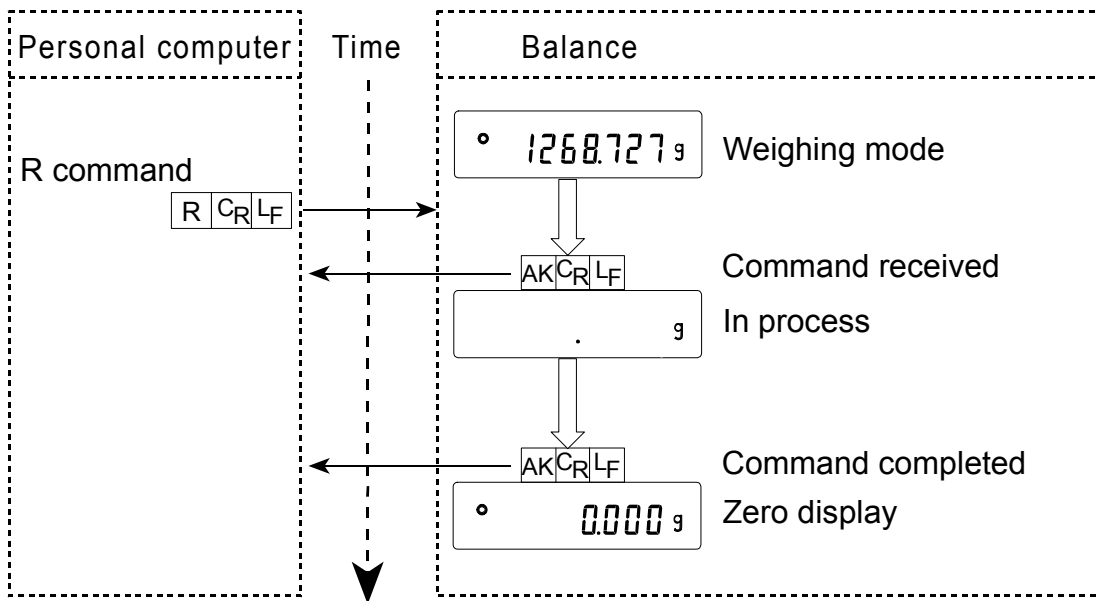

- When a communication error has occurred due to external noise, or a parity error has occurred due to transmission error, the balance transmits an error code. In this case, send the command again.

xx is error code number.

13-3. Control Using CTS and RTS

Depending on the "[t5]" parameter of "Serial interface (S iF)", the balance performs as follows:

[t5 0

Regardless of whether the balance can receive a command or not, the balance keeps the CTS line Hi. The balance outputs data regardless of the condition of the RTS line.

[t5 1

The CTS line is kept Hi normally. When the balance can not receive the next command (Example: while the balance is processing the last command), the balance sets the CTS line to Lo. The balance confirms the level of the RTS line before outputting a set of data. If the RTS level is Hi, the balance outputs data. If the RTS level is Lo, data is not output (The data is canceled).

13-4. Settings Related to RS-232C

Concerning the RS-232C, the balance has two functions: "Data output (*dout*)" and "Serial interface (S iF)". Set each function as necessary.

14. Extended Function

The MC series balance has several extended functions equipped for special applications or to troubleshoot when using the standard functions.

When the "Filter (*F IL*)" is set to " 0 ", extra items are available as shown below.

Class	Item and Parameter	Description		
<i>E r F n c</i> Extended function	<i>F 1-b</i> Averaging range for the first moving average	0	Small	When the fluctuation of a weight value is within the averaging range, the averaging operation starts to stabilize the displayed value. When the fluctuation of a weight value is small, for example, when weighing or filling a small amount of sample, the averaging is always performed and the response rate maybe slow. Under such a condition, change the parameter. Refer to "Averaging range (<i>F 1-b</i>) and averaging time (<i>F 1-t</i>)"
		1		
		2		
		3		
		▪ 4		
		5		
	<i>F 1-t</i> Averaging time for the first moving average	0	No averaging	When the fluctuation of a weight value is within the averaging range, the averaging operation starts. Once the duration of averaging operations reach the averaging time, moving averaging starts. This parameter sets the time to start moving averaging. Refer to "Averaging range (<i>F 1-b</i>) and averaging time (<i>F 1-t</i>)"
		1	0.5 second	
		▪ 2	1.0 second	
		3	1.5 seconds	
		4	2.0 seconds	
		5	2.5 seconds	
	6	3.2 seconds		
	<i>F 2-b</i> Averaging range for the second moving average	0	Small	Refer to "Filter depending on differences in the amount to deliver powdery and liquid material".
		▪ 1		
		2		
		3		
		4		
	5	Large		
	<i>F 2-t</i> Averaging time for the second moving average	0	No averaging	
1		0.5 second		
2		1.0 second		
3		1.5 seconds		
4		2.0 seconds		
▪ 5		2.5 seconds		
6	3.2 seconds			

▪ : Factory settings.

14-1. Description of "Averaging range" and "Averaging time"

14-1-1. Averaging Range ($F I-b$) and Averaging Time ($F I-t$)

1. When the fluctuation of a weight value is beyond the range that is selected in " $F I-b$ ", the averaging operation is disabled and the display reflects the varying value.
2. Once the fluctuation becomes within the selected range, the averaging operation starts to stabilize the weight value.
3. The process of averaging increases. When the selected time is reached, moving averaging will be performed.

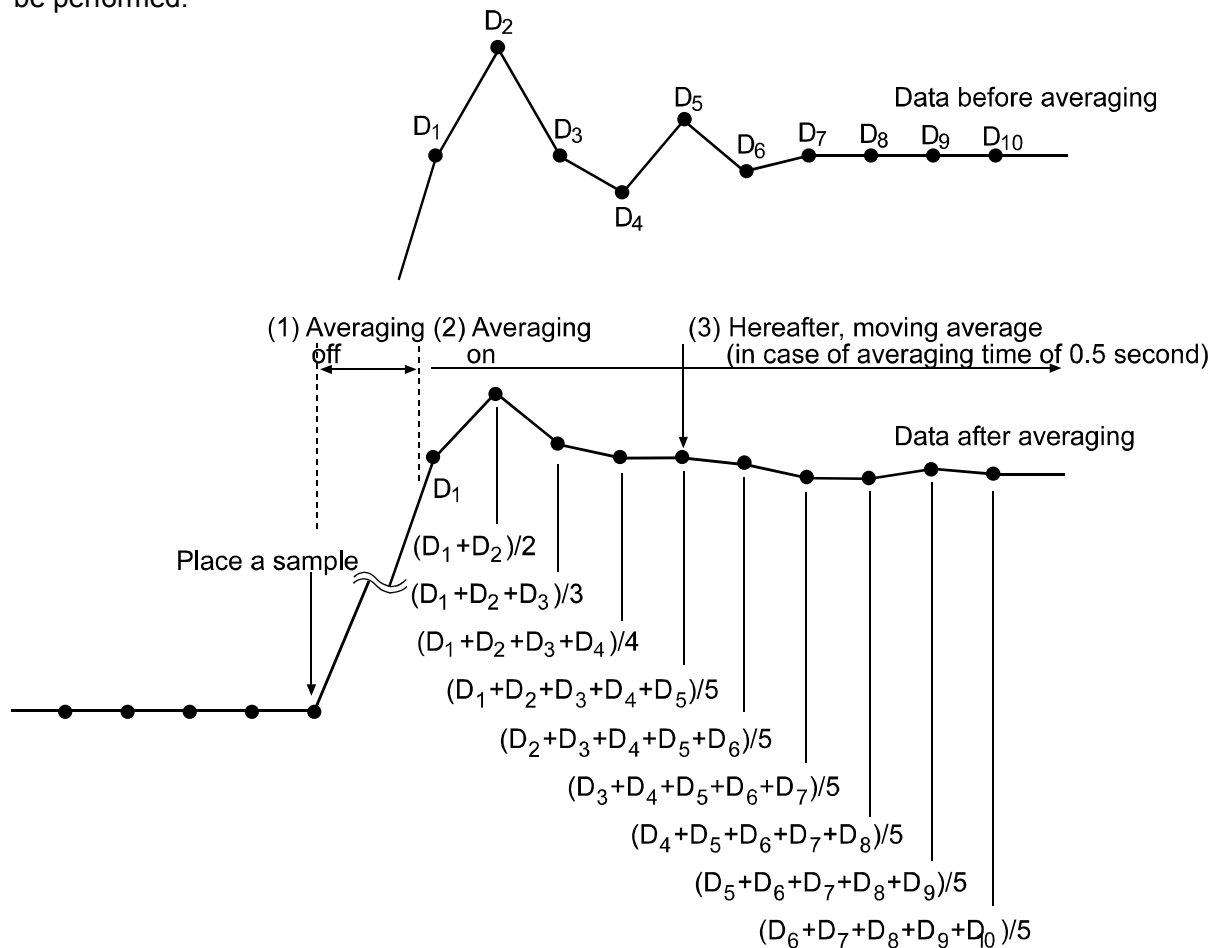

When a small amount of sample is weighed or is filled, the fluctuation of a weight value is too small to be beyond the selected range and the averaging operation is not disabled. Consequently moving averaging is always performed and it takes a longer time to reach the final weight value. Under such a situation, change the setting of " $F I-b$ " to a smaller range. But please note that the smaller the range is, the more prone to external disturbance the value will become.

14-1-2. Filter Depending on Differences in the Amount to Deliver Powdery and Liquid Material

- When the weight value is not stable even without load fluctuations
 - Increase the averaging range for the first moving average parameter ($F1-b$).
 - Increase the averaging time for the first moving average parameter ($F1-t$).
 - Strengthen the digital filter. (Increase the function setting “Condition ($Cond$)” parameter.)

- When response is slow during full and medium flow
 - Decrease the averaging range for the first moving average parameter ($F1-b$).
 - Weaken the digital filter. (Decrease the function setting “Condition ($Cond$)” parameter.)

- When response is slow during dribble flow
 - Decrease the averaging time for the first moving average parameter ($F1-t$).
 - Weaken the digital filter. (Decrease the function setting “Condition ($Cond$)” parameter.)

- To increase stability without load fluctuations
 - Increase the averaging range for the second moving average parameter ($F2-b$).
 - Increase the averaging time for the second moving average parameter ($F2-t$).

15. Maintenance

15-1. Treatment of the Balance

- In normal use, the balance can be cleaned with water. But, keep the following precautions so that dust and water do not invade the balance.
 - Do not direct water pressure at the bottom of the balance.
 - Do not use powerful water jets.
 - Do not submerge the balance in water.
- Clean the balance with a lint free cloth that is moistened with warm water and a mild detergent.
- Do not use organic solvents to clean the balance.
- Do not disassemble the balance. Contact the local A&D dealer if the balance needs service or repair.
- Use the original packing material for transportation.
- While cleaning the balance and keeping it waterproof, connect a waterproof RS-232C cable (GX-07K) or cover terminals of the RS-232C interface and AC adapter jack. Insure that the underhook cover is in place.
- The value of the internal mass may change due to aging, corrosion or other damage caused by the operating environment. Check the internal mass periodically. Correct the internal mass value as necessary.

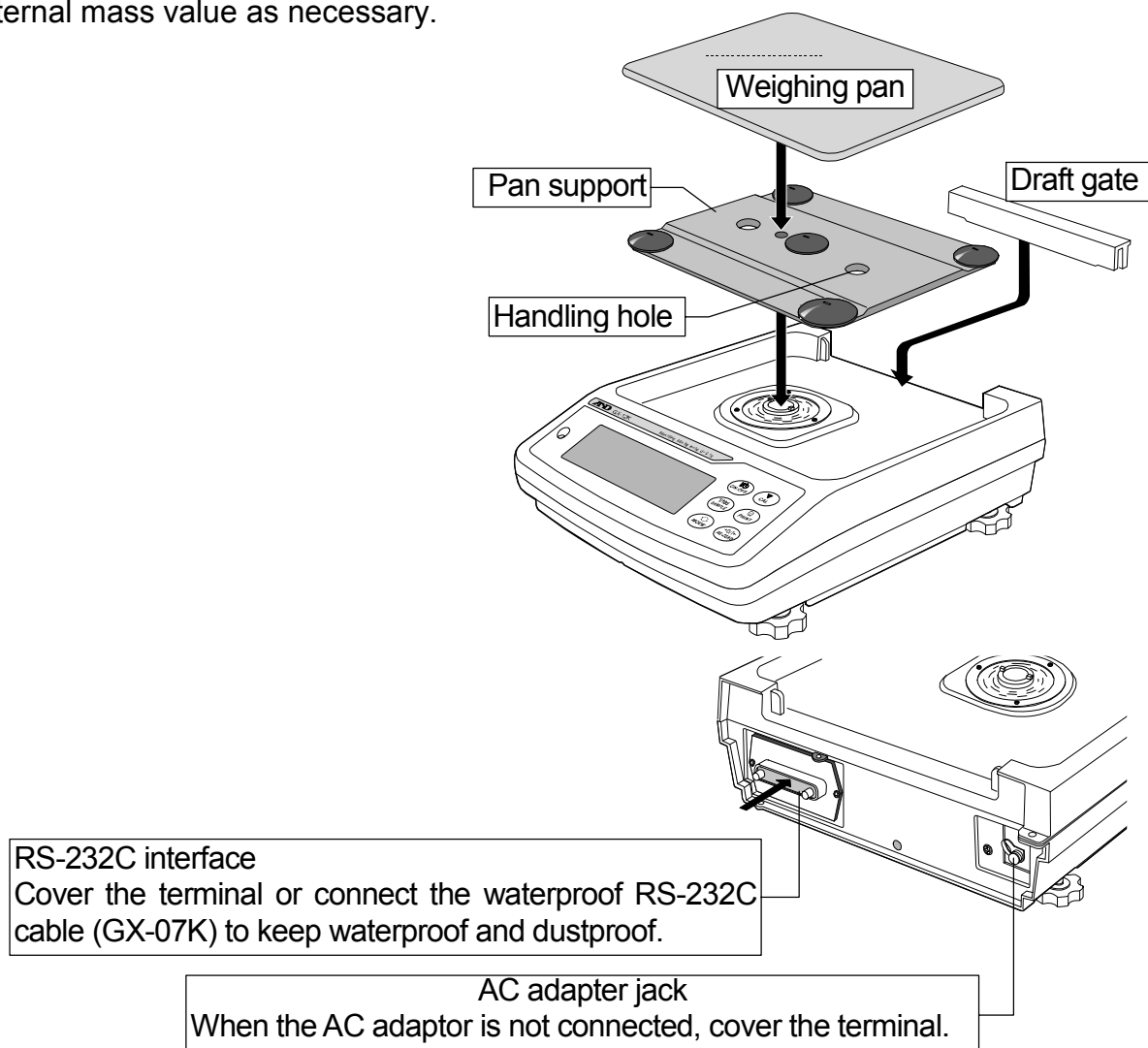

16. Troubleshooting

16-1. Checking the Balance Performance and Environment

The balance is a precision instrument. When the operating environment or the operating method is inadequate, correct weighing can not be performed. Place a sample on the pan and remove it, and repeat this several times. If the balance seems to have a problem with repeatability or to perform improperly, check as described below. If improper performance persists after checking, contact the local A&D dealer for repair.

Checking that the balance performs properly

- Check the balance performance using the self-check function as described in "7. Weighing Speed Adjustment / Self Check Function".
An error display appears when a malfunction is found.
- Check the balance repeatability using an external weight. Be sure to place the weight in the center of the weighing pan.
- Check the balance repeatability, linearity and calibrated value using external weights with a known value.

Checking that the operating environment or weighing method is proper

Operating environment

- Is the weighing table solid enough?
- Is the balance level? Refer to "3-1. Before Use".
- Is the operating environment free from vibration and drafts?
- Is there a strong electrical or magnetic noise source such as a motor near the balance?





Weighing method

- Does the weighing pan touch the rim or anything? Is the weighing pan and pan support installed correctly?
- Is the **RE-ZERO** key pressed before placing a sample on the weighing pan?
- Is the sample placed in the center of the weighing pan?
- Has the balance been calibrated using the internal mass (one-touch calibration)?
- Has the balance been warmed up for 30 minutes before weighing?

Sample and container

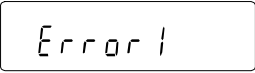
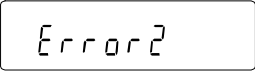
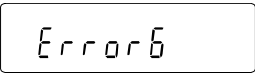
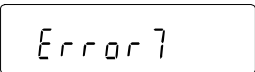
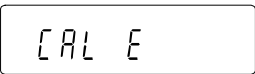
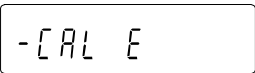
- Has the sample absorbed or lost moisture due to the ambient conditions such as temperature and humidity?
- Has the temperature of the container been allowed to equalize to the ambient temperature? Refer to "3-2. During Use".
- Is the sample charged with static electricity? Refer to "3-2. During Use".
- Is the sample of magnetic material such as iron? Caution is required for weighing magnetic materials. Refer to "3-2. During Use".

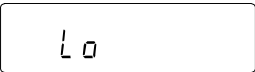
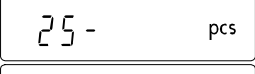
16-2. Error Codes

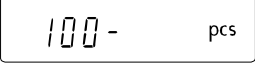
Display	Error code	Description
	EC,E11	Stability error The balance can not stabilize due to an environmental problem. Check around the pan. Refer to "3. Precautions". Prevent vibration, drafts, temperature changes, static electricity and magnetic fields, from influencing the balance. To return to the weighing mode, press the [CAL] key.
		Out of the setting range The data to be stored is out of the setting range.
	EC,E16	Internal mass error Applying the internal mass does not yield a change in the weight value as specified. Confirm that there is nothing on the pan and perform the weighing operation from the beginning again.
	EC,E17	Internal mass error The internal mass application mechanism does not function properly. Perform the weighing operation from the beginning again.
	EC,E20	Calibration weight error The calibration weight is too heavy. Confirm the calibration weight value. Press the [CAL] key to return to the weighing mode.
	EC,E21	Calibration weight error The calibration weight is too light. Confirm the calibration weight value. Press the [CAL] key to return to the weighing mode.
		Overload error A sample beyond the balance weighing capacity has been placed on the pan. Remove the sample from the pan.
		Weighing pan Error The weight value is too light. Confirm that the weighing pan is properly installed and calibrate the balance.
		Sample mass error The balance can not store the sample for the counting mode or for the percent mode because it is too light. Use a larger sample.
  		Unit mass error The sample unit mass for the counting mode is too light. Storing and using it for counting will cause a counting error. Add samples to reach the specified number and press the [PRINT] key. Pressing the [PRINT] key without adding samples will shift the balance to the counting mode. But, to acquire accurate weighing, be sure to add samples.

Display	Error code	Description
		Automatic response adjustment zero error The automatic response adjustment can not be performed because there is something on the pan. Clear the pan. Press the [CAL] key to return to the weighing mode.
 (Check NG)		Automatic response adjustment unstable error The automatic response adjustment can not be performed because the weight value is unstable. Check the ambient conditions such as breeze, vibration and magnetic fields, also check the weighing pan. Press the [CAL] key to return to the weighing mode.
 (Check no)		Internal error This error indicates an internal error as the result of the self-check function. Repair is required. Contact the local A&D dealer.
		Clock battery error The clock backup battery has been depleted. Press any key and set the time and date. The clock and calendar function works normally as long as the AC adapter is connected to the balance. If this error appears frequently, contact the local A&D dealer.
		Memory full The amount of weighing data in memory has reached the maximum capacity. Delete the data in memory to store new data. For details, refer to the GX-K manual "12. Data Memory".
		Memory full The amount of calibration or calibration test data in memory has reached the maximum capacity (50 sets). The data in memory will be deleted automatically to store new data. For details, refer to the GX-K manual "12. Data Memory".
		Memory type error The type of memory set in the function table and the type of data stored are different. For details, refer to the GX-K manual "12. Data Memory".
	EC,E00	Communications error A protocol error occurred in communications. Confirm the format, baud rate and parity.
	EC,E01	Undefined command error An undefined command was received. Confirm the command.
	EC,E02	Not ready A received command can not be processed. Example: <ul style="list-style-type: none"> □ The balance received a "Q" command, but not in the weighing mode. □ The balance received a "Q" command while processing a RE-ZERO command. Adjust the delay time to transmit a command.

Display	Error code	Description
	EC,E03	Timeout error If the timeout parameter is set to "t-UP l", the balance did not receive the next character of a command within the time limit of one second. Confirm the communication.
	EC,E04	Excess characters error The balance received excessive characters in a command. Confirm the command.
	EC,E06	Format error A command includes incorrect data. Example: □ The data is numerically incorrect. Confirm the command.
	EC,E07	Parameter setting error The received data exceeds the range that the balance can accept. Confirm the parameter range of the command.
Other error code		If an error described above can not be released or other errors are displayed, contact the local A&D dealer.

16-3. Other Display



When this indicator blinks, automatic self calibration is required. The indicator blinks when the balance detects changes in ambient temperature. If the balance is not used for several minutes with this indicator blinking, the balance performs automatic self calibration. The blinking period depends on the operating environment.

Advise The balance can be used while this indicator is blinking. We recommend that you perform automatic self calibration for precision weighing.

16-4. Asking for Repair

If the balance needs service or repair, contact your local A&D dealer.

The balance is a precision instrument. Use much care when handling the balance and observe the following when transporting the balance.

- Use the original packing material for transportation.
- Remove the draft gate, weighing pan and pan support from the main unit before placing the balance in the shipping container.

17. Specifications

	MC-10K	MC-30K
Weighing capacity	10.1 kg	31 kg
Maximum display	10.100844 kg	31.00844 kg
Minimum weighing value (1 digit)	0.001 g	0.01 g
Repeatability (Standard deviation) *1	0.005 g / 10 kg to 5 kg 0.004 g / 5 kg to 2 kg 0.0015 g / less than 2 kg	0.10 g / 30 kg to 20 kg 0.015 g / less than 20 kg
Linearity *1	±0.03 g	±0.2 g
Sensitivity drift, (10°C ~ 30°C / 50°F ~ 86°F)	±2 ppm/°C	±3 ppm/°C
Accuracy right after calibration using the internal mass *2 (Accuracy of full scale)	±0.150 g	±1.50 g
Operating environment	5°C to 40°C (41°F to 104°F), 85%RH or less (No condensation)	
Internal mass	Built-in function	
Weighing data of data memory	200 data, 100 data with calendar	
Time and clock function	Built-in function	
Display refresh rate	5 times/second or 10 times/second	
Display mode	g (gram)	
Interface (Provided as standard)	RS-232C	
External calibration weight	2 kg, 3 kg, 4 kg, 5 kg, 6 kg, 7 kg, 8 kg, 9 kg, 10 kg	20 kg, 30 kg
Weighing pan	270 x 210 mm	
External dimensions	300(W) x 355(D) x 111(H) mm	
Power supply & AC adapter type	Power consumption: Approx. 11VA (supplied to the AC adapter) Confirm that the adapter type is correct for the local voltage and power receptacle type.	
Weight	Approx. 9.3 kg	
Accuracy class F1	2 kg, 5 kg, 10 kg	20 kg
Dust and water protection	Complying with IP65	

*1: When the auto-centering pan is used or when loading and unloading are performed at the same place using the automatic loading machine under good ambient conditions.

*2: Accuracy right after calibration using the internal mass under good ambient conditions (within the temperature range of 10°C to 30°C (50°F to 86°F) with no abrupt changes in temperature or humidity, no drafts, no effect by magnetic fields or static electricity).

The value of the internal mass may change due to corrosion or other damage caused by the operating environment, or due to aging. Check the internal mass using an external weight periodically.

17-1. External Dimensions

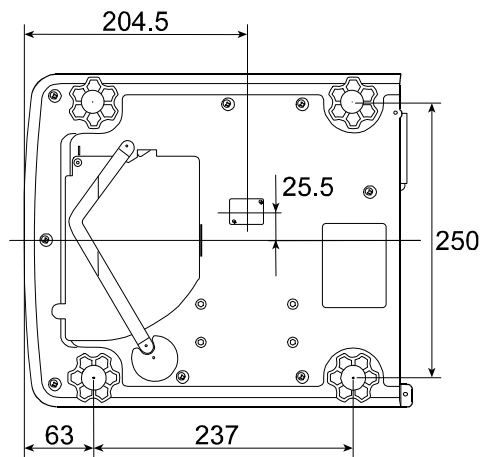
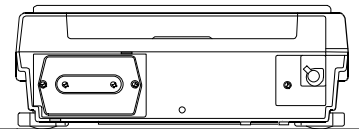
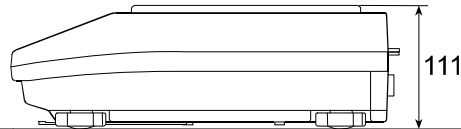
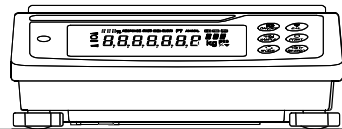
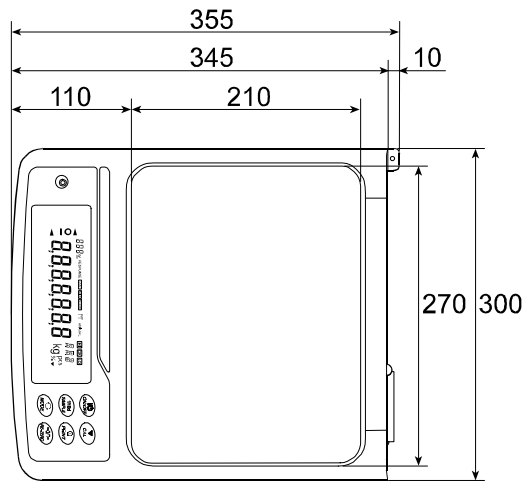

Unit: mm

17-2. Options and Peripheral Instruments

GX-04K: Comparator Output (Relay/ with a Buzzer) / RS-232C / Current Loop

- This option generates a relay output corresponding to **HI**, **OK** and **LO** in the display.
- Current loop and RS-232C can be used at the same time.
For example, a personal computer and an AD-8121B printer can be used simultaneously.
- This option is installed in place of the standard RS-232C serial interface.

GX-06K: Analog Voltage Output / Current Loop

- This option outputs a voltage of 0 to 1V (or 0.2 to 1V) depending on the displayed value.
- With this option, current loop can be used.
For example, an AD-8121B printer can be used simultaneously using this option.
- This option is installed in place of the standard RS-232C serial interface. So, RS-232C is not available for use.

Note When option GX-04K or GX-06K is installed in the balance, the balance does not comply with IP-65 (waterproof and dustproof).

GX-07K: Waterproof and Dustproof RS-232C Cable

- Length 5m, straight type, D-sub 9pin - D-sub 25pin.
- Only the 25pin connector of the balance side is a waterproof type.

GXK-012: Animal Weighing Bowl

- This bowl can be used to weigh a small animal.
- When using this bowl, the weighing range that can be used is an approximately 1.5 kg less than the weighing capacity.

AX-MC10K/30KPAN: Auto-centering Pan

- This option consists of an auto-centering pan, a breeze break and an auto-centering pan guide.

AX-GXK-31: Breeze break

AX-KO1710-200: RS-232C Cable

- Length 2m, straight type, D-sub 9pin - D-sub 25pin.

AD-8121B Printer

- Compact dot-matrix printer
- Statistical function, clock and calendar function, interval print function, graphic print function, dump print mode
- 5 x 7 dots, 16 characters per line
- Print paper (AX-PP143, 45 (W) x 50 (L) mm , ø65 mm)
- AC adapter or alkaline battery.

AD-1691: Weighing environment analyzer

- A tool to support various functions such as daily balance checks, uncertainty calculations and evaluations of the environment where the balance is installed.
- Being compact in size, can be carried to the balance installation site easily.
One analyzer can manage several balances.

AD-1687: Weighing environment logger

- A data logger equipped with 4 sensors for temperature, humidity, barometric pressure and vibration that can measure and store environmental data. When connected to the RS-232C interface of the balance, the AD-1687 can store environmental data along with weighing data. Therefore, it is possible to store data in an environment where a computer cannot be used.
- The stored data can be read to a personal computer using USB. As the AD-1687 is recognized as USB memory, special software is not required to read the data.

AD-1688: Data logger

- When connected to the RS-232C interface of the balance, the AD-1688 can store the data in an environment where a personal computer cannot be used.

AD-8526: Ethernet converter

- Used to connect the RS-232C interface of the balance to the Ethernet (LAN) port of a computer. This allows management of the balance weighing data with a computer connected to a network.

AD-8527: Quick USB adapter

- No dedicated power supply required. / No software required.
- Transmits the weighing data to a personal computer in real time and inputs the data directly into applications such as Excel or Word.
- IP65 compliant

AD-8920A: Remote display

- Can be connected to the balance using the RS-232C interface.

AD-8922A: Remote controller

- Can be connected to the balance using the RS-232C interface and can control the balance remotely.
- Various options such as comparator output or analog output are available.

AX-USB-25P-EX: USB converter

- Adds a COM port to a PC.
- Enables bi-directional communication between the PC and the balance when a USB driver is installed.
- Can use serial communication software such as WinCT on a PC without COM ports.
- An RS-232C cable is provided to connect the USB converter to the balance.

AD-1683: DC static eliminator

- A compact design with efficient static elimination.
- No air blowing from a fan allows precision weighing.

AD-1684A: Electrostatic field meter

- Measures the amount of the static charge on the sample, tare or peripheral equipment and displays the result.
- If those are found to be charged, discharge them using the AD-1683 DC static eliminator.

AD-1682 Rechargeable battery

- Allows use of the balance in a place where AC power is not available.

AX-SW128 Foot switch

- Connected to the connector (AX-HDB-25P), functions as the RE-ZERO key or PRINT key.

Note: Before using the foot switch, connect the connector, the connector cover and the foot switch.

AX-HDB-25P/CTF Connector

- Consists of a connector (AX-HDB-25P) and a connector cover (AX-HDB-CTF).
- Creates a contact that functions in the same way as the RE-ZERO key or PRINT key.
- An RS-232C cable is provided to connect the USB converter to the balance.

18. Terms/Index

















18-1. Terms

Calibration	Adjustment of the balance so that it can weigh accurately.
Calibration weight	A weight used for calibration
Data number	Numbers assigned sequentially when weighing data or unit weight is stored.
Digit	The minimum weighing value available. Used for the balance, one digit is the smallest mass that can be displayed.
Environment	Ambient conditions such as vibration, drafts, temperature, static electricity and magnetic fields which affect the weighing operation.
External weight	The weight that you have.
GLP	Good Laboratory Practice.
Internal mass	Built-in calibration weight
IP-65	IP code: Degree of protection provided by enclosures. 6: Dust-tight. No ingress of dust. 5: Protect against water jets.
Mode	Balance operational function.
Output	To output the weighing data using the RS-232C interface.
Range	A combination of weighing range and resolution.
Repeatability	Variation in measured values obtained when the same mass is placed and removed repetitively. Usually expressed as a standard deviation. Example: Standard deviation = 1 digit: This means that measured values, obtained when the same sample is placed and removed repetitively, fall within ± 1 digit in the frequency of about 68%.
Re-zero	To set the display to zero.
Sensitivity drift	An affect that a change in temperature causes to the weighing data. Expressed as a temperature coefficient. Example: Temperature coefficient = 2 ppm/ $^{\circ}$ C : If a load is 8 kg and the temperature changes by 10° C, the value displayed changes by the following value. $0.0002\%/^{\circ}$ C $\times 10^{\circ}$ C $\times 8$ kg = 0.16 g In this example, if the value displayed is 8000.00 g before temperature changes, a temperature change of 10° C will make the value displayed 8000.16 g.
Smart range function	The function allows weighing in the precision range, even if a heavy tare is used.

Stable value	The stable weight data, indicated by the illuminated stabilization indicator.
Stabilization time	Time required after a sample being placed, until the stabilization indicator illuminates and the weighing data is displayed.
Store	To save the weighing data, unit mass or calibration data using the data memory function.
Tare	To cancel the weight of a container which is not to be included in the weighing data. Normally, refers to an operation of placing a container and setting the display to zero.
Target weight	An external weight used for calibration test
Zero point	A weighing reference point. Usually refers to the value displayed when nothing is on the weighing pan.

18-2. Index

Keys and symbols

	CAL key	12
	MODE key	12, 15
	ON OFF key	12
	PRINT key	12
	RE-ZERO key	12, 28
	SAMPLE key	12, 28
	Animal indicator	12
	Calibration will start	12, 20
	Capacity indicator	12
	Data number	12
	Interval memory mode	12
	Process indicator	12, 20
	Space mark	40, 41, 42
	Stabilization indicator	12, 28
	Standby indicator	12
	RESPONSE FAST MID SLOW Weighing speed	12, 17

- A -

A&D format	4
AC adapter	8
Accessory	61
AD-1682 Rechargeable battery	62
AD-1683 DC static eliminator	61
AD-1684A Electrostatic field meter	61
AD-1687 Weighing environment logger	61
AD-1688 Data logger	61
AD-1691 Weighing environment analyzer	60
AD-8121B Printer	60
AD-8526 Ethernet converter	61
AD-8527 Quick USB adapter	61
AD-8920A Remote display	61
AD-8922A Remote controller	15, 61
<i>Add</i> add	29
AK code	48
<i>AP-b</i> Auto print difference	30, 34, 45
<i>Ar-d</i> Zero after output	31
<i>AP-P</i> Auto print polarity	30, 34, 45
<i>At-F</i> Auto feed	31, 45
Auto-centering pan	3, 7
Auto-centering pan guide	7
Averaging range	50, 51
averaging time	50, 51
AX-GXK-31 Breeze break	60
AX-HDB-25P/CTF Connector	62
AX-K01710-200 RS-232C cable	9, 60
AX-MC10K/30KPAN Auto-centering Pan	60
AX-SW128 Foot switch	62
AX-USB-25P-EX USB converter	61

- B -

<i>bRSFnc</i> Environment display	29
---	----

<i>bEP1</i> LO buzzer	30
<i>bEP2</i> OK buzzer	30
<i>bEP3</i> HI buzzer	30
<i>bPS</i> Baud rate	31, 45
<i>btPr</i> Data bit, parity bit	31, 45

- C -

<i>-CAL E</i> Calibration weight error	55
<i>[AL E</i> Calibration weight error	55
<i>[AL in</i> One-touch calibration	21
<i>[AL out</i> Calibration using an external weight ..	22
<i>[AL,</i> Automatic self calibration	20
Calibration	19, 23, 63
Calibration test	19
Calibration weight	19
<i>[C out</i> Calibration test	23
<i>[H 0</i> Response error	56
<i>[H n0</i> Check NG	18
<i>[H no</i> Check NO	18
<i>[L Add</i> Clock	29
<i>[Lr</i> Initializing the balance	27
<i>[and</i> Condition	15, 29, 33
<i>[P</i> Comparator mode	29
<i>[P Fnc</i> Comparator	29
<i>[P H,1</i> Upper limit	30
<i>[P in</i> Data input method	29
<i>[P Lnt</i> Tolerance	30
<i>[P Lo</i> Lower limit	30
<i>[P rEF</i> Reference value	30
<i>[P-b</i> Main display comparison	30
<i>[P-r</i> Comparison results	29
<i>[rLF</i> Terminator	31, 45
<i>[S in</i> Internal mass correction	32
CSV format	36
<i>[tS</i> CTS, RTS control	31, 45
CTS	49

- D -

<i>dAtA</i> Data memory	30
Data number	63
Digit	63
<i>d-no</i> Data number output	31
<i>dout</i> Data output	30, 34
Dump print	35

- E -

<i>-E</i> Weighing pan Error	55
<i>E</i> Overload error	55
EC,E00 Communications error	56
EC,E01 Undefined command error	56
EC,E02 Not ready	56
EC,E03 Timeout error	57
EC,E04 Excess characters error	57
EC,E06 Format error	57
EC,E07 Parameter setting error	57

EC,E11	Stability error.....	55
EC,E16	Internal mass error	55
EC,E17	Internal mass error	55
EC,E20	Internal mass error	55
EC,E21	Internal mass error	55
Eccentric loading error.....		3, 7
<i>ErCd</i>	AK, Error code.....	31
<i>Error 1</i>	Stability error.....	55
<i>Error 2</i>	Out of the setting range	55
<i>Error 6</i>	Internal mass error	55
<i>Error 7</i>	Internal mass error	55
Error code		55
Extended function		32, 50
External weight		19, 20, 63
- F -		
<i>FiL</i>	Filter	15
FAST	17
<i>FULL</i>	Memory full	56
<i>GS1</i>	Capacity indicator.....	29
- G -		
GX-04K	60
GX-06K	60
GX-07K	9, 60
GXK-012	Animal weighing bowl	60
- H -		
<i>Hold</i>	Hold function.....	29
- I -		
<i>id</i>	ID number setting	32
ID Number	39
<i>inFo</i>	GLP output	31
<i>int</i>	Interval time	30
Internal mass.....		19
IP-65	9
- K -		
KF format	36
- L -		
<i>Lo</i>	Sample mass error.....	55
- M -		
Mass comparator		3, 7, 15, 29
MID.	17
<i>mLt</i>	Programmable-unit (Multi-unit).....	31
Mode	63
MT format	36
- N -		
Numerical format		36

- O -		
Option 60	
- P -		
<i>PS</i>	internal mass correction..... 24	
<i>Pnt</i>	Decimal point..... 29	
<i>PaFF</i>	Auto display-OFF	29
<i>P-on</i>	Auto display-ON	29
<i>Prt</i>	Data output mode..... 30, 34, 45	
<i>PUSE</i>	Data output pause	31, 45
- R -		
Range 63	
<i>rEcEnd</i>	End block	42
Repeatability.....		63
Re-zero 63	
<i>rnG</i>	Display at start	29
RsCom 46	
RsKey 46	
<i>rTc</i>	Clock battery error	56
RTS 49	
- S -		
<i>S-id</i>	ID number output..... 31, 45	
<i>S-iF</i>	Serial interface..... 31	
SLOW 17	
Smart range function		63
Span calibration.....		16, 33
<i>SPd</i>	Display refresh rate	29
Stabilization time		63
Stable value.....		63
<i>StPrt</i>	Title block	42
<i>St-b</i>	Stability band width..... 29, 33	
<i>S-tD</i>	Time/Date output	31
Store 63	
- T -		
Tare 64	
Target weight.....		19, 64
<i>tRc</i>	Zero tracking	29
<i>t-UP</i>	Timeout	31
<i>tYPE</i>	Data format	31, 45
- U -		
<i>Unit</i>	Unit..... 32	
- W -		
WinCT	Communication Tools Software ... 46	
- Z -		
Zero point 64	
Zero upon power-on		16, 33

About the MC series balance function settings

□ Factory settings have been changed for stable weighing

The factory settings described on page 31 of the MC series instruction manual have been changed.

The MC series are high resolution balances. Therefore, external disturbances such as breezes or vibrations may cause unstable weighing values.

For stable weighing, the factory settings of the following functions have been changed to those more resistant to external disturbances, as shown below.

New factory settings

Class	Item and Parameter		Description
bR5Fnc Environment Display	<i>Cond</i>	Condition	▪ 2 Slow response rate, stable value "SLOW"
	<i>F iL</i>	Filter	▪ 1 Used

Note: When the balance initialization is performed, the function settings will be changed as shown below. After initialization, confirm that the settings are appropriate before weighing.

Settings after initialization

Class	Item and Parameter		Description
bR5Fnc Environment Display	<i>Cond</i>	Condition	1 "MID."
	<i>F iL</i>	Filter	0 Not used

□ For stable weighing

When weighing values are unstable even with the functions set to those more resistant to external disturbances ("*Cond*" to "1" and "*F iL*" to "0"), use the AD-1672 Tabletop Breeze Break to protect the balance from breezes.

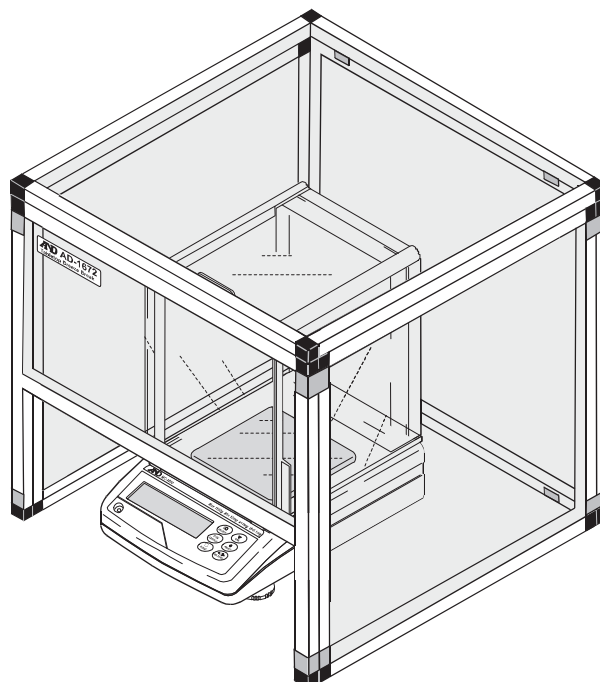

Usage example: AD-1672 Tabletop Breeze Break and MC-1000 Balance