



T500E

DIGITAL WEIGHT INDICATOR

Setup / Operation Manual

Revision 2.7
May 18, 2008

13-01 Pollitt Drive Fair Lawn, NJ 07410
Tel (800) 631-0347 Fax (888) 797-2288
<http://www.totalcomp.com/>

TABLE OF CONTENTS

	Page
INTRODUCTION.....	1
FCC NOTE.....	1
INSTALLATION.....	1
PREPARATION.....	1
CONNECTIONS.....	2
CONNECTING THE WEIGH PLATFORM.....	2
CONNECTING THE SERIAL I/O DEVICE.....	3
CONNECTING THE POWER SUPPLY.....	3
CONFIGURATION.....	4
OVERVIEW.....	4
ACCESSING THE MENUS.....	4
MENU STRUCTURE.....	4
SETUP MENU DESCRIPTIONS.....	5
USER MENU DESCRIPTIONS.....	7
USER MENU PROCEDURES.....	8
EXITING THE MENUS.....	8
CALIBRATION.....	9
CALIBRATION OVERVIEW.....	9
ZERO CALIBRATION (F16).....	9
SPAN CALIBRATION (F17).....	9
VIEW CALIBRATION VALUES (F18).....	10
KEY-IN ZERO CALIBRATION VALUE (F19).....	10
KEY-IN SPAN CALIBRATION VALUE (F20).....	11
OPERATION.....	11
DISPLAY.....	11
KEYBOARD.....	12
FUNCTION KEYS.....	12
GENERAL SCALE OPERATION.....	12
WEIGHING AN ITEM.....	12
PIECE COUNTING MODE.....	13
LEGAL FOR TRADE SEALING.....	13
APPENDIX A: SPECIFICATIONS.....	14
APPENDIX B: SERIAL PORT INFORMATION.....	15
SERIAL PORT MODES.....	15
DEMAND DUPLEX MODE.....	15
CONTINUOUS DUPLEX MODE.....	15
OUTPUT STRINGS.....	16
TEXT PRINT TICKET.....	16
STRING FORMAT 1 (Condec Demand String).....	16
STRING FORMAT 2 (Condec Continuous String).....	16
APPENDIX C: DISPLAYED ERROR CODES.....	17

©Totalcomp, Inc. 2008. All rights reserved.

The information contained herein is the property of Totalcomp, inc and is supplied without liability for errors or omissions. No part may be reproduced or used except as authorized by contract or other written permission. The copyright and the foregoing restriction on reproduction and use extend to all media in which the information may be embodied.

Contents subject to change without notice.

INTRODUCTION

The T500E Digital Indicator is a general purpose, industrial grade weight indicator. Two models are currently available, distinguishable by display type, enclosure type and power supply. Table 1 shows the T500E Series product matrix.

All models operate identically, can readout up to 50,000 display divisions and can supply enough current for up to 4-350 Ω load cells. All setup parameters may be entered via the front panel keys, including calibration.

If your Model T500E Series Digital Indicator is part of a complete floor scale or has already been installed for you, you may skip to the operating instructions. Prior to using the indicator, please read this chapter carefully and completely. Store the manual in a safe and convenient place so it will be available if you have questions concerning the operation of the scale.

MODEL	DISPLAY TYPE	ENCLOSURE TYPE	POWER SOURCE
T500E	LED	Mild Steel/ ABS	AC adapter - 9 VDC, 500 mA

TABLE 1: T500E Series Product Matrix

FCC NOTE

This equipment has been tested and found to comply with the limits for a Class A digital device, pursuant to Subpart J of Part 15 of the FCC Rules. These limits are designed to provide reasonable protection against harmful interference when the equipment is operated in a commercial environment. This equipment generates uses and can radiate radio frequency energy and, if not installed and used in accordance with the instructions manual, may cause harmful interference to radio communications. Operation of this equipment in a residential area is likely to cause harmful interference in which case the user will be required to correct the interference at his/her own expense.

INSTALLATION

PREPARATION

Any precision instrument requires a suitable environment in which to operate as intended. Please review each of the following prior to installation:

Electrical Power

The T500E indicators have been designed to operate from 9 to 12 VDC and ships with an AC adapter designed to operate from the local line voltage. All units ship with the appropriate power plug for its area of intended use.

To avoid electrical noise interference and/or stray AC electrical transients, try to operate the indicator from a circuit separate from any equipment containing inductive devices such as a contactor coil, solenoid, relay coil, or motor. Be sure to use shielded cables for the load cell connections (ground shield wire at indicator) and run these cables away from your AC/DC power cables if possible.

In extreme cases, it may be necessary to install surge suppressors, line conditioners or even UPS (Uninterruptible Power Supplies) systems (not included).

Environment

- Avoid installing the indicator in areas of direct sunlight or high humidity
- Avoid sudden temperature change – if this is unavoidable allow equipment to 'soak' at a constant temperature for at least three hours before use
- Ensure that steady, clean AC power is available to the unit

Remember that the installer is ultimately responsible to assure that a particular installation will be and remain safe and operable under the specific conditions encountered.

CONNECTIONS

For the T500E model, the rear panel contains all connectors necessary to make the appropriate connections to the weigh platform, printer, remote display and power supply.

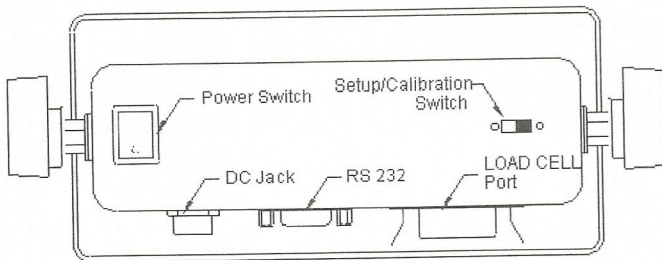

Caution! Disconnect power source from indicator prior to removing rear cover.

CONNECTING THE WEIGH PLATFORM

The T500E ships with a premium 15 ft shielded load cell cable for connection to weigh platform's load cell(s) or junction box.

1. Plug the cable's 14-pin parallel interface connector into the load cell port on the rear panel of the indicator.
2. Wire the bare wires and shield to the weigh platform's load cell(s) or junction box using the color codes shown below.

4-wire cable

<u>Color</u>	<u>Wire Name</u>
Red	+ Excitation
Black	- Excitation
Green	+ Signal
White	- Signal

Optional 6-wire cable

<u>Color</u>	<u>Wire Name</u>
Red	+Excitation
Black	-Excitation
Green	+Signal
Yellow	- Signal
Orange	+ Sense
Brown	- Sense

Load Cell Connector J4

<u>Pin No.</u>	<u>Wire Name</u>	<u>Pin No.</u>	<u>Wire Name</u>
1	+ Excitation	5	+ Signal
2	+ Sense	6	- Signal
3	- Excitation	7	Shield
4	- Sense		

CONNECTING THE SERIAL I/O DEVICE

The T500E model comes standard with one full duplex RS-232 serial port, designed for connection to a computer or a serial printer. The same port may be also used as a simplex, RS-232 port designed for connection to a remote display.

DSUB9 Connector

<u>Pin No.</u>	<u>Wire Name</u>
2	RXD
3	TXD
5	Ground

CONNECTING THE POWER SUPPLY

The T500E indicator ships standard with an external AC adapter.

1. Simply plug the AC adapter into the indicator's DC Power Jack first, and then plug into a standard wall outlet. ***Make sure that the AC voltage appearing at the wall outlet matches the input voltage marked on the AC adapter.***

CONFIGURATION

OVERVIEW

The indicator contains two main configuration menus:

- The Setup ("F") menu, which configures the indicator to your weigh platform
- The User ("A") menu, which configures the serial communication port and enables some user options

The Setup and User menus consist of several menu selections, each with its own sub-menu of selections or programming procedures. To configure the indicator you must first enter the appropriate menu mode. Once there, four of the front panel keys become directional navigators to move around in the menus, and one key is used to save or SET the selections.

ACCESSING THE MENUS

To access the Setup ("F") menu:

1. Power off the indicator.
2. Locate the slide switch on the rear cover and move it to the opposite position.
NOTE: A metal plate held on by two drilled-head screws may conceal the slide switch.
3. Power on the indicator.
The display shows " F 1" to indicate that you are in Setup Menu mode.
4. Use the navigation keys shown in the Figure 10 to move through the menu.

To access the User ("A") menu:

1. Enter the Setup ("F") menu.
2. Use the right or left directional keys shown below to move right or left in the Setup ("F") menu until the indicator shows " A 1".

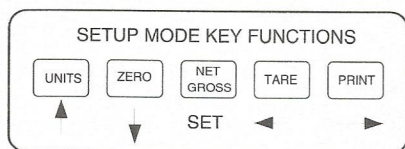

MENU STRUCTURE

All menus consist of a top level (heading) and a secondary level. The top level contains the code (e.g. F1) for the parameter to be configured. The secondary level contains the selection list or allows access to a programming sequence.

Use the directional keys to move around in the Menu Structure shown below.

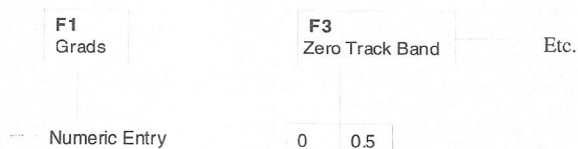

1. To move to a new heading, use the TARE (left) or PRINT (right) key to move right or left in the Menu.
2. To move to the selection or programming level, press the ZERO (down) key once. The currently saved selection is shown.
3. To view the available selections for the current heading, use the TARE (left) or PRINT (right) key to move through the selection field.
4. To save a new selection, press the NET/GROSS (Set) key .To exit without saving, press the UNITS (up) key to return to the current heading.
5. Repeat Steps 2 through 5 until the Menu is programmed.

SETUP MENU DESCRIPTIONS

This section provides more detailed descriptions of the selections found in the Setup Menu Chart. Factory-set defaults are shown in bold with a checkmark.

NOTE: Some selections are subject to local legal metrology regulations

CODE/NAME	DESCRIPTION	SELECTION LIST
F1 Graduations	Specifies number of full-scale graduations, i.e. capacity / division. Value should be consistent with legal regulations and environmental limits on the useful system resolution.	500 1,000 1,500 2,000 2,500 3,000 4,000 5,000 √ 6,000 8,000 10,000 12,000 20,000 30,000 40,000 50,000
F3 Zero Track Band	Selects the range within which the scale will automatically zero. Note that the scale must be in standstill to automatically zero. Selections are in display divisions (d).	0d 0.5d √ 1d 3d 5d
F4 Zero Range	Selects the range (expressed as a percentage of full scale capacity) within which the scale may be zeroed. Note that the indicator must be in standstill to zero the scale.	100% √ 1.9%
F5 Motion Band	Sets the level at which motion is detected. If motion is not detected, the scale can process a Print or Zero command. Maximum value varies depending on local regulations. Expressed as scale divisions per second (d/s).	1d √ 3d 5d 10d
F6 Digital Filter	Averages weight readings to produce higher stability. Choose the speed that works best for your application. "FAST" = Fast "nnEd" = Medium "SLo" = Slow	FAST nnEd √ SLo

CODE/NAME	DESCRIPTION	SELECTION LIST
F7 Overload Limit	Selects the desired formula which determines the point at which the indicator shows overload. All selections are based on the primary unit selected in F8. "FS" = Full scale capacity.	FS FS + 2%√ FS + 1d FS + 9d
F8 Calib. Unit	Selects the primary base unit to be used in the calibration process. Also the default unit for normal operation. "1" = primary unit is lb. "2" = primary unit is in kg.	1√ 2
F9 Display Divisions	Determines the desired weight increments. Value should be consistent with legal requirements.	1√ 2 5
F10 Decimal Pt.	Determines location of the decimal point.	0√ 0.0 0.00 0.000 0.0000 00
F16 Zero Calibration	Places indicator into the zero calibration routine. Scrolling down with the ZERO key one level begins the procedure.	Press ZERO key to begin sequence
F17 Span Calibration	Places indicator into the span calibration routine. Scrolling down with the ZERO key one level begins the procedure.	Press ZERO key to begin sequence
F18 View Calibration	Actuates the function that allows you to view both the zero and span calibration value. The values displayed in this function are valid only after Calibration (F16 & F17) has been successfully completed. Scrolling down with the ZERO key one level begins the procedure.	Press ZERO key to begin sequence
F19 Key-in Zero	Allows you to key-in known zero calibration value in case of memory loss in the field. Scrolling down with the ZERO key one level begins the procedure.	Press ZERO key to begin sequence
F20 Key-in Span	Allows you to key-in a known span calibration value in case of memory loss in the field. Scrolling down with the ZERO key one level begins the procedure.	Press ZERO key to begin sequence
F21 Factory Reset	This sub-menu will reset all parameters in the "F" and "A" menu to the default settings. USE WITH CAUTION!	Press the ZERO key twice to execute.
F24 Piece Count Enable	Used to enable or disable the piece count feature. This feature must be disabled for commercial applications. "0" = Disable piece count "1" = Enable piece count	0√ 1

USER MENU DESCRIPTIONS

This section provides more detailed descriptions of the selections found in the User Menu Chart. Factory-set defaults are shown in bold with a checkmark.

NAME/CODE	DESCRIPTION	CODE/VALUE
A1 Baud Rate	Selects the baud rate for data transmission through the serial port.	1200 2400 4800 9600 ✓ 19200
A2 Data Bits and Parity	Selects the number of data bits and parity of serial transmission. "8n" = 8 data bits with no parity bit and one stop bit "7O" = 7 data bits with odd parity bit and one stop bit "7E" = 7 data bits with even parity bit and one stop bit "7n" = 7 data bits with no parity bit and two stop bits	8n ✓ 7O 7E 7n
A3 Mode of Serial Transmission	Selects when data will be sent out of the serial port to a printer or computer: "C" = Continuous mode; send data continuously "d" = Demand mode; send data when a PRINT command is issued from the printer, computer, or indicator.	C d✓
A4 Display Check	Actuates the function that illuminates all digit segments, decimal points, and LCD annunciators in a test sequence. Pressing the ZERO key to scroll down one level begins the test sequence.	Press ZERO key to begin sequence
A5 Disable the lb/kg Key	Allows the lb/kg key to be disabled so that an operator cannot accidentally press the key and change the displayed units. "0" = Disable the lb/kg key "1" = Enable the lb/kg key	0 1✓
A6 Serial Port Mode	Selects the mode of the RS-232 serial port: Refer to Appendix B for more information. "0" = Full Duplex Mode "1" = Print Ticket Mode	0 1✓
A7 ID No. Enable	Allows the ID number to be disabled in the Print Ticket mode. Valid only when A6 is set to "1". "0" = Disable the ID No. "1" = Enable the ID No.	0 ✓ 1
A8 ID No. Entry	Actuates the function that allows entry of a new ID No. Valid only when A6 is set to "1". Pressing the ZERO key to scroll down one level begins the sequence.	0 - 999999 123456 ✓
A9 No. of Line Feeds	Actuates the function that allows entry of the desired number of line feeds to be printed in Print Ticket Mode. Valid only when A6 is set to "1". Pressing the ZERO key to scroll down one level begins the sequence.	0 - 99 8 ✓
A10 Handshaking Enable	Enables hardware handshaking for Print Ticket Mode. Valid only when A6 is set to "1". "0" = Disable Handshaking "1" = Enable Handshaking	0 ✓ 1
A11 Print Header	Tells MP-20 printer to print the header information. Valid only when A6 is set to "1". "0" = Do NOT Print Header "1" = Print Header	0 ✓ 1

USER MENU PROCEDURES

This section provides instructions for all of the User Menu procedures.

ID Number Entry (A8)

1. While in the User Menu mode, scroll to "A 8", then scroll down once using the ZERO key to enter the ID Number menu.
2. The display will momentarily show "ID NO", followed by a value with one flashing digit. This value will be the current ID number value.
3. Use the four directional keys (shown below) to adjust the displayed value to the actual ID Number value. Increase the flashing digit by pressing the UNITS key. Decrease the flashing digit by pressing the ZERO key. Pressing the PRINT key or the TARE key will change the position of the flashing digit.



4. After setting the exact value, press the NET/GROSS key to save the ID Number value. The display will show "SET" momentarily, and then revert back up to A8.

LF (Line Feeds) Number Entry (A9)

1. While in the User Menu mode, scroll to "A 9", and then scroll down once using the ZERO key to enter the Line Feeds menu.
2. The display will momentarily show "LF", followed by the current line feeds value.
3. Use the four directional keys shown above to adjust the displayed value to the actual line feeds value. Increase the flashing digit by pressing the UNITS key. Decrease the flashing digit by pressing the ZERO key. Pressing the PRINT key or the TARE key will change the position of the flashing digit.
4. After setting the exact value, press the NET/GROSS key to save the line feeds value. The display will show "SET" momentarily, and then revert back up to A9.

EXITING THE MENUS

Exit any configuration menu by moving the slide switch to its original position. The display will go through a digit check, and then settle into Normal Operating mode. All front panel keys will now return to their normal mode of operation.

CALIBRATION

CALIBRATION OVERVIEW

If your indicator was shipped as a complete scale, then calibration is not necessary. Please check with your installer or supplier if you are unsure. Transcell recommends having your weighing equipment checked by a qualified scale technician at least once a year depending on its intended use and working environment.

The indicator requires two types of calibration: zero and span. Zero calibration (F16) requires the scale to be empty (nothing on scale) and the span calibration (F17) requires known test weights. After a successful calibration, you should record all calibration values in Table 2 using the F18 View Calibration procedure.

In the unlikely event that any calibration value is lost, the setup menu makes provisions for re-entering these values via F19 and F20; thus eliminating the need for re-calibration with test weights.

NOTE: This section assumes that the indicator is in Setup ("F") Menu mode. If the indicator is not in Setup Menu mode, refer to previous section for instructions.

ZERO CALIBRATION (F16)

1. While in the Setup mode, scroll to "F 16", then scroll down once using the ZERO key to enter zero calibration menu. The display will momentarily show "C 0" followed by a value. This value is the internal A/D count and can prove useful when trying to troubleshoot setup problems.
2. After making sure that there are no test weights on the platform, press the ZERO key again to zero out the displayed value.
3. Press the NET/GROSS key to save the zero point value. The display will show "EndC0" momentarily, and then revert back up to F16. At this time, proceed to the F17 span calibration to complete indicator calibration.

SPAN CALIBRATION (F17)

1. While in the Setup mode, scroll to "F 17", then scroll down once using the ZERO key to enter span calibration menu. The display will momentarily show "C 1" for the span calibration point, followed by a value with one flashing digit. This value will be zero with the Decimal Point parameter selected in F10.
2. Place the test weight on the weighing platform.
3. Use the four directional keys to adjust the displayed value to the actual test weight value. Increase the flashing digit by pressing the UNITS key. Decrease the flashing digit by pressing the ZERO key. Pressing the PRINT key or the TARE key will change the position of the flashing digit.
4. After entering the exact value, press the NET/GROSS key to save the value. If the calibration was successful, the display will show "EndC1" momentarily, and then revert back up to F17

5. At this time it is suggested that the calibration values be recorded for future use (see next section).

If the calibration was *not* successful, one of the error messages below will appear. Take the indicated action to correct the problem, then perform a new calibration.

"Err0" - The calibration test weight or the keyed-in weight is larger than the full capacity of the scale. Change the calibration test weight or check the input data.

"Err1" - The calibration test weight or the keyed-in weight is smaller than 1% of the full capacity of the scale. Change the calibration test weight or check the input data.

"Err2" - There is not enough signal from the load cells to establish a proper calibration. Most common causes include incorrect load cell wiring, a mechanical obstruction or a faulty (damaged) load cell.

VIEW CALIBRATION VALUES (F18)

Note: The values displayed in this procedure are valid only after a successful calibration has been performed using F16 and F17.

1. While in the Setup mode, scroll to **"F 18"**, then scroll down once using the ZERO key to enter View calibration menu.
2. The display will show the information listed in Table 2. The code will display briefly followed by the value. It is recommended that you record each value in the table below. Press any key to continue down the list. At the completion of the list, the indicator reverts back up to F18.

ZERO CALIBRATION VALUE (C0)	SPAN CALIBRATION VALUE (C1)

Table 2: Calibration Value Table

KEY-IN ZERO CALIBRATION VALUE (F19)

Note: This procedure is intended for emergency use only in the case of non-volatile memory loss. A valid zero calibration value, obtained from a successful F16 calibration procedure, must be used.

1. While in the Setup mode, scroll to **"F 19"**, then scroll down once using the ZERO key. The display will momentarily show **"CAL 0"**, followed by a value of zero
2. Use the four directional keys to enter in the actual zero calibration value.
3. After entering the exact value, press the NET/GROSS key to save the value. The display will show **"E CAL 0"** momentarily, and then revert back up to F19.

KEY-IN SPAN CALIBRATION VALUE (F20)

Note: This procedure is intended for emergency use only in the case of non-volatile memory loss. Valid span calibration values, obtained from a successful F17 calibration procedure, must be used.

1. While in the Setup mode, scroll to "F 20", and then scroll down once using the ZERO key. The indicator will prompt you to enter the CAL 1 span calibration data from Table 2.
2. Use the four directional keys to enter in the actual calibration value
3. After setting the exact value, press the NET/GROSS key to save the value.
4. If the entered values are entered successfully, the display will show "E CAL 1" momentarily before reverting back up to F20.

OPERATION

DISPLAY

This model utilizes a 6-digit LED (Light Emitting Diode) display. Table 4 summarizes the display annunciators.



LED Annunciator	MEANING
ZERO	Better known as the "Center of Zero" annunciator, this light is active whenever the displayed weight is within a pre-programmed band from true zero.
NET	Indicates that the indicator is displaying net weight.
GROSS	Indicates that the indicator is displaying gross weight.
TARE	Indicates that a tare weight has been established in the system.
lb, kg, PCS	Indicates the unit of the displayed weight. PCS stands for "pieces".
STABLE	This light is on whenever the scale is stable.

TABLE 4: T500E Annunciator Definitions

KEYBOARD

The keyboard is composed of five function keys shown below.



FUNCTION KEYS

Units – This key toggles the indicator among the available weight units if enabled in the User (“A”) menu. Available weight units include lb, kg and pieces.

Zero - This key sets the indicator to display zero provided the following conditions are met:

1. The indicator is displaying Gross weight.
2. The displayed weight is within the zero reset range that is programmed in F4 of the Setup (“F”) Menu.
3. The scale is not in motion.
4. The scale is not in overload (see Appendix D for error codes).

Net/Gross - This key toggles the indicator between Gross weight and Net weight only if a Tare has been established.

Tare - This key is used to establish a Tare provided the following conditions are met:

1. The indicator is not at or below Gross zero.
2. The scale is not in motion.
3. The scale is not in overload (see Appendix D for error codes).

Print - This key is used to send weight information out to the serial port provided the following conditions are met:

1. The scale is not in motion.
2. The scale is not in overload (see Appendix D for error codes).

GENERAL SCALE OPERATION

WEIGHING AN ITEM

1. Select the desired weighing unit by pressing the lb/kg key until that unit is indicated on the display.
2. If necessary, press the ZERO key to obtain a weight reading of zero.
3. If weighing an item in a container, place the empty container on the scale’s platter and, after allowing the weight indication to stabilize, press the TARE key. The display shows zero weight and turns the NET annunciator on
4. Place the object to be weighed on the scale’s platter and allow the weight indication to stabilize. If the item weight exceeds the scale’s weight capacity, it displays “oooooo”.
5. Read the weight shown on the display. If you have established a tare, you may toggle between the gross weight and the net weight by pressing the NET/GROSS key

PIECE COUNTING MODE

IMPORTANT NOTE: The piece counting function cannot be used in commercial (NTEP) applications.

To activate this mode, set F24 to 1. This mode is used to indicate the number of pieces of an item you have placed on the scale's platform and is accessed by pressing the **UNITS** key. To ensure accuracy, the parts you are counting must be consistent in weight.

The indicator uses the sampling method to determine the average piece weight (APW) of the items you wish to count. When sampling items, always count the parts in your hand and place them on the platform all at once. If the APW of the items is too light or the total weight of the sample is too light, accuracy cannot be guaranteed. You will get an error message, but piece counting will still be allowed. This indicator does not retain the piece weight when powered down.

1. If the items you will be counting require a container, you must first tare the container off by pressing the **TARE** key.
NOTE: The **TARE** key is inoperative when in sampling mode.
2. Press the **UNITS** key until "5 0" is indicated on the display. If the screen does not show "5 0", press the **ZERO** key once. The indicator is prompting you to place five identical items on the platform.
NOTE: If you wish to change the sample number, simply press the **UNITS** key repeatedly until the desired sample number appears. Available choices are 5, 10, 20, 50 and 100. If you continue to push the **UNITS** key, the indicator will resort back to weighing mode and you must start again from Step 2.
3. Place the sample items on the platform all at once and allow the weight indication to stabilize. Once this is done, the zero indicated after the sample number will change to a "--". For example, "5 --".
4. Press the **NET/GROSS** key to take the sample. If the sample size is large enough, the indicator now displays the number of pieces on the platform and the "PCS" annunciator is lit. If not, the indicator briefly displays "Lo" and automatically increments the sample size. Repeat Step #4 with the new sample size.
NOTE: If the indicator continues to display "Lo" even after sampling 100 pieces, the unit weight of the items you wish to count is too light for your scale to process accurately.
5. To exit the piece count mode, press the **UNITS** key.
NOTE: The APW will NOT remain in scale memory when you exit piece counting mode.

LEGAL FOR TRADE SEALING

Indicators can be sealed for commercial (Legal for Trade) applications as follows.

1. Power off the indicator.
2. On the back of the indicator, locate the setup/calibration switch cover.
3. Thread a wire security seal through both drilled head screws securing the calibration switch cover as well as the single drilled head screw holding on the rear panel.

APPENDIX A: SPECIFICATIONS

ANALOG SPECIFICATIONS

Full Scale Input Signal	±3.125 mV/V
Minimum Sensitivity - Non trade	0.3 μ V / grad
Minimum Sensitivity - H-44	0.6 μ V / grad
Input Impedance	30M Ω , typical
Internal Resolution	Approximately 260,000 counts @ 2mV/V input
Display Resolution	6,000 display division max
Measurement Rate	10 Hz
System Linearity	Within 0.02% of FS
Calibration Method	Software Calibration, with long term storage in EEPROM
Excitation Voltage	+5 VDC, 4 x 350 Ω load cells

DIGITAL SPECIFICATIONS

Microcontrollers	Winbond W78E58
Program Memory	32K x 8, internal to μ C
SRAM:	512 x 8, internal to μ C (Standard Chipset)
EEPROM:	126 x 8, external to μ C
Digital Filtering	Software selectable

SERIAL COMMUNICATIONS

Serial Port	Full Duplex, selectable Baud rate
	8 data bits, no parity, 1 stop bit
	7 data bits, odd parity, 1 stop bit
	7 data bits, even parity, 1 stop bit
	7 data bits, no parity, 2 stop bits

OPERATOR INTERFACE

Display – LED Indicators	0.56" (14 mm) 7-segment, LED, 6 Digit
Additional Symbols	Net, Gross, Stable, Tare, lb, kg, Zero, PCS
Keyboard	5-key flat membrane panel

POWER

T500E (AC Adapter)	9 VDC, 500mA Female
DC Power Consumption	200mA + 15mA/350 Ω Load Cell
Fuse (Internal)	1A 250V SLOW BLOW

ENVIRONMENTAL

Operating Temperature	-10° to +40° C
Storage Temperature	-25° to +70° C

MECHANICAL

Overall Dimensions (L x W x H) – T500E Plus	8.5" x 3.0" x 4.6" (215mm x 75mm x 117mm)
--	---

APPROVALS

NTEP	COC # 96-028
------	--------------

APPENDIX B: SERIAL PORT INFORMATION

SERIAL PORT MODES

DEMAND DUPLEX MODE

The Demand Duplex Mode (A3 = 'd', A6 = '0') provides a two way serial transmission mode. In this mode, the output information is transmitted on demand; either by pressing the **PRINT** key on the indicator's front panel or upon receiving a recognized command from a host device (i.e. computer).

NOTE: Ensure that your cabling contains the proper handshaking.

CONTINUOUS DUPLEX MODE

The Continuous Duplex Mode (A3 = 'C', A6 = '0') provides a two-way serial transmission mode. In this mode, the output information is transmitted continuously making it a popular choice for remote displays and other remote devices requiring a constant data stream. The transmission automatically occurs at the end of each display update. The indicator will react upon receiving a recognized command from a host device.

RECOGNIZED HOST COMMANDS (applies to both demand and continuous duplex modes)

- "P" - This command is sent to the indicator to print the indicated display. The indicator will not respond if the scale is in motion, positive overload or negative overload.
- "Z" - This command is sent to the indicator to zero the scale. The indicator will not respond if the scale is in motion, positive overload or negative overload. The indicator will also not respond if it is not in gross mode or within the zero range specified in F4 of the Setup Menu.
- "T" - This command is sent to the indicator to tare the scale. The indicator will not respond if the scale is in motion, positive overload or negative overload. The indicator will also not respond if it displaying a negative gross value.
- "G" - This command is sent to the indicator to switch to gross mode. The indicator will not respond if the scale is in motion, positive overload or negative overload.
- "N" - This command is sent to the indicator to revert to net. The indicator will not respond if the scale is in motion, positive overload or negative overload. The indicator will also not respond if a tare has yet to be established.
- "C" - This command is sent to the indicator to toggle among the configured units of measure.



T500ESS

Digital Weight Indicator

Setup / Operation Manual

Revision 1.0
July 8, 2009

TABLE OF CONTENTS

	<u>Page</u>
INTRODUCTION.....	1
FCC NOTE.....	1
INSTALLATION.....	1
PREPARATION.....	1
CONNECTIONS.....	2
CONNECTING THE WEIGH PLATFORM.....	2
CONNECTING THE SERIAL I/O DEVICE.....	2
CONNECTING THE POWER SUPPLY.....	3
CONFIGURATION.....	3
OVERVIEW.....	3
ACCESSING THE MENUS.....	3
MENU STRUCTURE.....	3
SETUP MENU DESCRIPTIONS.....	5
SETUP MENU PROCEDURES.....	7
USER MENU DESCRIPTIONS.....	8
USER MENU PROCEDURES.....	9
EXITING THE MENUS.....	9
CALIBRATION.....	10
CALIBRATION OVERVIEW.....	10
ZERO CALIBRATION (F16).....	10
SPAN CALIBRATION (F17).....	10
VIEW CALIBRATION VALUES (F18).....	11
KEY-IN ZERO CALIBRATION VALUE (F19).....	12
KEY-IN SPAN CALIBRATION VALUE (F20).....	12
OPERATION.....	13
DISPLAY.....	13
KEYBOARD.....	13
FUNCTION KEYS.....	14
GENERAL SCALE OPERATION.....	14
WEIGHING AN ITEM.....	14
PIECE COUNTING MODE.....	14
PEAK HOLD MODE.....	15
REMOTE DISPLAY MODE.....	15
LEGAL FOR TRADE SEALING.....	16
APPENDIX A: SPECIFICATIONS.....	17
APPENDIX B: SERIAL PORT INFORMATION.....	18
SERIAL PORT MODES.....	18
DEMAND DUPLEX MODE.....	18
CONTINUOUS DUPLEX MODE.....	18
AUTO PRINT MODE.....	18
OUTPUT STRINGS.....	19
TEXT PRINT TICKET.....	19
STRING FORMAT 1 (Condec Demand String).....	19
STRING FORMAT 2 (Condec Continuous String).....	19
APPENDIX C: DISPLAYED ERROR CODES.....	20

©Totalcomp, Inc. 2009. All rights reserved.

The information contained herein is the property of Totalcomp and is supplied without liability for errors or omissions. No part may be reproduced or used except as authorized by contract or other written permission. The copyright and the foregoing restriction on reproduction and use extend to all media in which the information may be embodied.

Contents subject to change without notice.

13-01 Pollitt Drive Fair Lawn, NJ 07410
Tel (800) 631-0347 Fax (888) 797-2288
<http://www.totalcomp.com/>

INTRODUCTION

The T500ESS Digital Indicator is a general purpose, industrial grade weight indicator. One model is currently available, distinguishable by display type, enclosure type and power supply. Table 1 shows the T500ESS product matrix.

This model can readout up to 50,000 display divisions and can supply enough current for up to 4-350 Ω load cells. All setup parameters may be entered via the front panel keys, including calibration.

If your Model T500ESS Digital Indicator is part of a complete floor scale or has already been installed for you, you may skip to the operating instructions. Prior to using the indicator, please read this chapter carefully and completely. Store the manual in a safe and convenient place so it will be available if you have questions concerning the operation of the scale.

MODEL	DISPLAY TYPE	ENCLOSURE TYPE	POWER SOURCE
T500ESS	LED	Stainless Steel	100-240 VAC, 50/60 Hz 30W

TABLE 1: T500ESS Series Product Matrix

FCC NOTE

This equipment has been tested and found to comply with the limits for a Class A digital device, pursuant to Subpart J of Part 15 of the FCC Rules. These limits are designed to provide reasonable protection against harmful interference when the equipment is operated in a commercial environment. This equipment generates, uses and can radiate radio frequency energy and, if not installed and used in accordance with the instructions manual, may cause harmful interference to radio communications. Operation of this equipment in a residential area is likely to cause harmful interference in which case the user will be required to correct the interference at his/her own expense.

INSTALLATION

PREPARATION

Any precision instrument requires a suitable environment in which to operate as intended. Please review each of the following prior to installation:

Electrical Power

The T500ESS indicator has been designed to operate from 100 to 240 VAC at 50/60 Hz. All units ship with the appropriate power plug for its area of intended use.

To avoid electrical noise interference and/or stray AC electrical transients, try to operate the indicator from a circuit separate from any equipment containing inductive devices such as a contactor coil, solenoid, relay coil, or motor. Be sure to use shielded cables for the load cell connections (ground shield wire at indicator) and run these cables away from your AC/DC power cables if possible.

In extreme cases, it may be necessary to install surge suppressors, line conditioners or even UPS (Uninterruptible Power Supplies) systems (not included).

Environment

- Avoid installing the indicator in areas of direct sunlight or high humidity
- Avoid sudden temperature change – if this is unavoidable allow equipment to ‘soak’ at a constant temperature for at least three hours before use
- Ensure that steady, clean AC power is available to the unit

Remember that the installer is ultimately responsible to assure that a particular installation will be and remain safe and operable under the specific conditions encountered.

CONNECTIONS

The rear cover must first be removed to make the appropriate connections to the weigh platform, printer, remote display and power supply. To remove the rear cover, simply remove the screws that secure it to the enclosure and set aside.

Caution! Disconnect power source from indicator prior to removing rear cover.
--

CONNECTING THE WEIGH PLATFORM

The TI-500E-SS indicator contains a connection terminal on the main board for connection to the load cell cable. Connect your shielded load cell cable (not included) to the appropriate terminal on the main board.

NOTE: 6-wire connection is optional.

Load Cell Connector J4

<u>Pin No.</u>	<u>Wire Name</u>	<u>Pin No.</u>	<u>Wire Name</u>
1	Shield	5	- Excitation
2	- Signal	6	+ Sense
3	+ Signal	7	+ Excitation
4	- Sense		

CONNECTING THE SERIAL I/O DEVICE

The T500ESS model comes standard with one full duplex RS-232 serial port, designed for connection to a computer or a serial printer. The same port may be also used as a simplex, RS-232 port designed for connection to a remote display.

Connection assignments for all serial RS-232 communication terminals on the TI-500E-SS are shown below.

RS-232 Connector J3

<u>Pin No.</u>	<u>Wire Name</u>	<u>Pin No.</u>	<u>Wire Name</u>
1	TXD	4	CTS
2	RXD	5	Ground
3	RTS		

CONNECTING THE POWER SUPPLY

The TI-500E-SS indicator ships with an AC line cord attached to the indicator. Simply plug the unit into a standard wall outlet.

CONFIGURATION

OVERVIEW

The indicator contains two main configuration menus:

- The Setup ("F") menu, which configures the indicator to your weigh platform
- The User ("A") menu, which configures the serial communication port and enables some user options

The Setup and User menus consist of several menu selections, each with its own sub-menu of selections or programming procedures. To configure the indicator you must first enter the appropriate menu mode. Once there, four of the front panel keys become directional navigators to move around in the menus, and one key is used to save or SET the selections.

ACCESSING THE MENUS

To access the Setup ("F") menu:

1. Power off the indicator.
2. Locate the slide switch on the rear cover and move it to the opposite position.
NOTE: A metal plate held on by two drilled-head screws may conceal the slide switch.
3. Power on the indicator.
The display shows " F 1" to indicate that you are in Setup Menu mode.
4. Use the navigation keys shown in the figure below to move through the menu.

To access the User ("A") menu:

1. Enter the Setup ("F") menu.
2. Use the right or left directional keys shown below to move right or left in the Setup ("F") menu until the indicator shows " A 1".

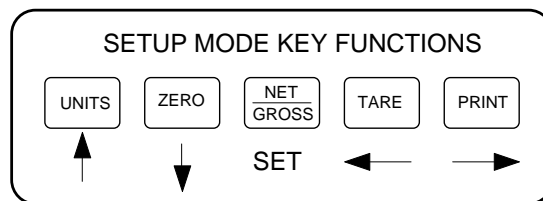

MENU STRUCTURE

All menus consist of a top level (heading) and a secondary level. The top level contains the code (e.g. F1) for the parameter to be configured. The secondary level contains the selection list or allows access to a programming sequence.

Use the directional keys to move around in the Menu Structure shown below.

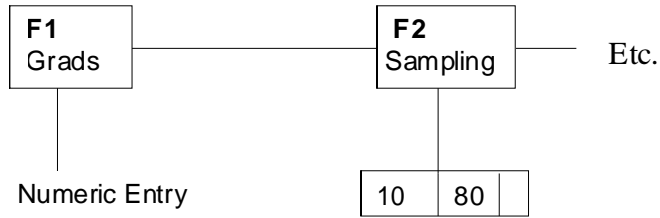

1. To move to a new heading, use the TARE (left) or PRINT (right) key to move right or left in the Menu.
2. To move to the selection or programming level, press the ZERO (down) key once. The currently saved selection is shown.
3. To view the available selections for the current heading, use the TARE (left) or PRINT (right) key to move through the selection field.
4. To save a new selection, press the NET/GROSS (Set) key. To exit without saving, press the UNITS (up) key to return to the current heading.
5. Repeat Steps 2 through 5 until the Menu is programmed.

SETUP MENU DESCRIPTIONS

This section provides more detailed descriptions of the selections found in the Setup Menu Chart. Factory-set defaults are shown in bold; **(NA)** for North America and **(€)** for Europe.

NOTE: Some selections are subject to local legal metrology regulations

CODE/NAME	DESCRIPTION	SELECTION LIST
F1 Graduations	Specifies number of full-scale graduations, i.e. capacity / division. Value should be consistent with legal regulations and environmental limits on the useful system resolution. Pressing the ZERO key to scroll down one level begins the sequence	Key-in 100 - 50000 5000 (NA) 3000 (€)
F2 Sampling Rate	Sets the sampling rate in Hertz (measurements per second). Use 10 Hz for most applications or 80 Hz for extra fast response time	10 (NA/€) 80
F3 Zero Track Band	Selects the range within which the scale will automatically zero. Note that the scale must be in standstill to automatically zero. Selections are in display divisions (d).	0d 0.5d (NA/€) 1d 3d 5d
F4 Zero Range	Selects the range (expressed as a percentage of full scale capacity) within which the scale may be zeroed. Note that the indicator must be in standstill to zero the scale.	100% (NA) 1.9% 2% (€) 20%
F5 Motion Band	Sets the level at which motion is detected. If motion is not detected, the scale can process a Print or Zero command. Maximum value varies depending on local regulations. Expressed as scale divisions per second (d/s). Pressing the ZERO key to scroll down one level begins the sequence	Key-in 0.0d/s – 32.0d/s 1.0d/s (NA/€)
F6 Digital Filter	Averages weight readings to produce higher stability. Choose the speed that works best for your application. "FAST" = Fast "nnEd" = Medium "SLo" = Slow	FAST nnEd (NA/€) SLo
F7 Overload Limit	Selects the desired formula which determines the point at which the indicator shows overload. All selections are based on the primary unit selected in F8. "FS" = Full scale capacity.	FS FS + 2% (NA) FS + 5% FS + 1d FS + 9d (€)
F8 Calib. Unit	Selects the primary base unit to be used in the calibration process. Also the default unit for normal operation. "1" = primary unit is lb. "2" = primary unit is in kg.	1 (NA) 2 (€)
F9 Display Divisions	Determines the desired weight increments. Value should be consistent with legal requirements.	1 (NA) 2 5 (€)
F10 Decimal Pt.	Determines location of the decimal point.	0 (NA) 0.0 (€) 0.00 0.000 0.0000 00

CODE/NAME	DESCRIPTION	SELECTION LIST
F14 Units Conversion	Allows the lb/kg key to be disabled so that an operator cannot accidentally press the key and change the displayed units. "0" = Disable the Units key "1" = Enable the Units key	0 (€) 1 (NA)
F16 Zero Calibration	Places indicator into the zero calibration routine. Scrolling down with the ZERO key one level begins the procedure.	Press ZERO key to begin sequence
F17 Span Calibration	Places indicator into the span calibration routine. Scrolling down with the ZERO key one level begins the procedure.	Press ZERO key to begin sequence
F18 View Calibration	Actuates the function that allows you to view both the zero and span calibration value. The values displayed in this function are valid only after Calibration (F16 & F17) has been successfully completed. Scrolling down with the ZERO key one level begins the procedure. Multi-point cal	Press ZERO key to begin sequence
F19 Key-in Zero	Allows you to key-in known zero calibration value in case of memory loss in the field. Scrolling down with the ZERO key one level begins the procedure.	Press ZERO key to begin sequence
F20 Key-in Span	Allows you to key-in a known span calibration value in case of memory loss in the field. Scrolling down with the ZERO key one level begins the procedure.	Press ZERO key to begin sequence
F21 Factory Reset North America	This sub-menu will reset all parameters in the "F" and "A" menu to the default settings for North America. USE WITH CAUTION!	Press the ZERO key twice to execute.
F22 Factory Reset Europe	This sub-menu will reset all parameters in the "F" and "A" menu to the default settings for Europe. USE WITH CAUTION!	Press the ZERO key twice to execute.
F23 Fine Tune 4-20 mA	Actuates the function that allows you to fine-tune the optional 4-20 mA analog output. Pressing the ZERO key to scroll down one level begins the sequence.	Press the ZERO key to begin sequence
F30 Special Application	Used to select one special application feature, subject to local legal requirements. "0" = None (Gross/Net), "2" = Remote Display, "3" = Piece Count, "5" = Peak Hold	0 (NA/€) 2 3 5
F31 Gross Zero Band	Selects the range within which the scale will automatically clear the tare and switch to Gross mode. Note that the scale must be in standstill. Selections are in display divisions (d). Scrolling down with the ZERO key one level begins the procedure. "0" = Disabled	Key-in 0 - 10 0 (NA) 10 (€)
F32 Center of Zero Band	Selects the range around gross zero within which the scale will display the Center of Zero annunciator. Selections are in display divisions (d).	0.25d (US) 0.5d (€)

CODE/NAME	DESCRIPTION	SELECTION LIST
F34 Auto Print Min. Weight	Selects the minimum weight at which the auto print function will work if enabled. Selections are in display divisions (d). Scrolling down with the ZERO key one level begins the procedure. "0" = Disabled	Key-in 0 - 100 1 (NA/€)

SETUP MENU PROCEDURES

This section provides instructions for all of the Setup Menu procedures except F16 through F20 whose procedures can be found in the Calibration section.

Fine-tune 4-20 mA output (F23)

1. While in the Setup Menu mode, scroll to "F 23", then scroll down once using the ZERO key to enter Fine-tune menu. The indicator outputs 4 mA and displays a number.
2. While monitoring the voltage across R_L (see Appendix E), use the right (PRINT) or left (TARE) keys to change the displayed value until the measured voltage is exactly 1 VDC.
3. Press the SET (Net/Gross) key to save. The indicator outputs 20 mA and displays another number.
4. While monitoring the voltage across R_L , use the right (PRINT) or left (TARE) keys to change the displayed value until the measured voltage is exactly 5 VDC.
5. Press the SET (Net/Gross) key to save and revert back to F23.

USER MENU DESCRIPTIONS

This section provides more detailed descriptions of the selections found in the User Menu Chart. Factory-set defaults are shown in bold; **(NA)** for North America and **(€)** for Europe.

CODE/NAME	DESCRIPTION	SELECTION LIST
A1 Baud Rate	Selects the baud rate for data transmission through the serial port.	300, 600, 1200, 2400, 4800, 9600 (NA/€) , 19200, 38400
A2 Data Bits and Parity	Selects the number of data bits and parity of serial transmission. "8n" = 8 data bits with no parity bit and one stop bit "7O" = 7 data bits with odd parity bit and one stop bit "7E" = 7 data bits with even parity bit and one stop bit "7n" = 7 data bits with no parity bit and two stop bits	8n (NA/€) 7O 7E 7n
A3 Serial Port Mode	Selects the mode of the I/O serial port: Refer to Appendix B for more information. "0" = Demand Duplex "1" = Continuous Duplex "2" = Auto Print	0 (NA/€) 1 2
A4 Diagnostics	NOTE: Standard Chipset supports display check only Actuates the function that illuminates all digit segments, decimal points, and LCD annunciators in a test sequence.	Press ZERO key to begin sequence
A6 Output String	Selects fixed output string for serial port (Standard Chipset only). Refer to Appendix B for details. "0" = Text Print Ticket "1" = String Format 1 (Condec Demand) "2" = String Format 2 (Condec Continuous)	0√ (NA/€) 1 2
A7 ID No. Enable	Allows the ID number to be enabled for Print Ticket output. "0" = Disable the ID No. "1" = Enable the ID No.	0 (NA/€) 1
A8 ID No. Entry	Actuates the function that allows entry of a new ID No. Pressing the ZERO key to scroll down one level begins the sequence.	0 – 999999 99 (NA/€)
A9 No. of Line Feeds	Actuates the function that allows entry of the desired number of line feeds to be printed for Print Ticket output. Pressing the ZERO key to scroll down one level begins the sequence.	0 - 99 8 (NA/€)
A10 Print Header	Tells MP-20 printer to print the header information for Print Ticket output. "0" = Do NOT Print Header "1" = Print Header	0 (NA/€) 1
A11 Handshaking	Selects handshaking for serial port. "0" = Off (no handshaking) "1" = RTS/CTS	0√ (NA/€) 1
A34 Decimal Point	Selects printed (not displayed) decimal point character. "0" = Period ('.') "1" = Comma (',')	0 (NA) 1 (€)

USER MENU PROCEDURES

This section provides instructions for all of the User Menu procedures.

ID Number Entry (A8)

1. While in the User Menu mode, scroll to "**A 8**", then scroll down once using the ZERO key to enter the ID Number menu.
2. The display will momentarily show "**ID NO**", followed by a value with one flashing digit. This value will be the current ID number value.
3. Use the four directional keys (shown below) to adjust the displayed value to the actual ID Number value. Increase the flashing digit by pressing the UNITS key. Decrease the flashing digit by pressing the ZERO key. Pressing the PRINT key or the TARE key will change the position of the flashing digit.

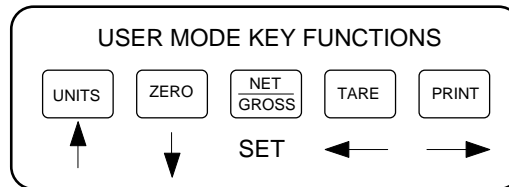

4. After setting the exact value, press the NET/GROSS key to save the ID Number value. The display will show "**SET**" momentarily, and then revert back up to A8.

LF (Line Feeds) Number Entry (A9)

1. While in the User Menu mode, scroll to "**A 9**", and then scroll down once using the ZERO key to enter the Line Feeds menu.
2. The display will momentarily show "**LF**", followed by the current line feeds value.
3. Use the four directional keys shown in Figure 11 to adjust the displayed value to the actual line feeds value. Increase the flashing digit by pressing the UNITS key. Decrease the flashing digit by pressing the ZERO key. Pressing the PRINT key or the TARE key will change the position of the flashing digit.
4. After setting the exact value, press the NET/GROSS key to save the line feeds value. The display will show "**SET**" momentarily, and then revert back up to A9.

EXITING THE MENUS

Exit any configuration menu by moving the slide switch to its original position. The display will go through a digit check, and then settle into Normal Operating mode. All front panel keys will now return to their normal mode of operation.

CALIBRATION

CALIBRATION OVERVIEW

If your indicator was shipped as a complete scale, then calibration is not necessary. Please check with your installer or supplier if you are unsure. Totalcomp recommends having your weighing equipment checked by a qualified scale technician at least once a year depending on its intended use and working environment.

The indicator requires two types of calibration: zero and span. Zero calibration (F16) requires the scale to be empty (nothing on scale) and the span calibration (F17) requires known test weights. After a successful calibration, you should record all calibration values in Table 2 using the F18 View Calibration procedure.

In the unlikely event that any calibration value is lost, the setup menu makes provisions for re-entering these values via F19 and F20; thus eliminating the need for re-calibration with test weights.

NOTE: This section assumes that the indicator is in Setup ("F") Menu mode. If the indicator is not in Setup Menu mode, refer to previous section for instructions.

ZERO CALIBRATION (F16)

1. While in the Setup mode, scroll to "**F 16**", then scroll down once using the ZERO key to enter zero calibration menu. The display will momentarily show "**C 0**" followed by a value. This value is the internal A/D count and can prove useful when trying to troubleshoot setup problems.
2. After making sure that there are no test weights on the platform, press the ZERO key again to zero out the displayed value.
3. Press the NET/GROSS key to save the zero point value. The display will show "**EndC0**" momentarily, and then revert back up to F16. At this time, proceed to the F17 span calibration to complete indicator calibration.

SPAN CALIBRATION (F17)

1. While in the Setup mode, scroll to "**F 17**", then scroll down once using the ZERO key to enter span calibration menu. The display will momentarily show "**C 1**" for the first span calibration point, followed by a value with one flashing digit. This value will be zero with the Decimal Point parameter selected in F10.
2. Place the first test weight on the weighing mechanism.
3. Use the four directional keys to adjust the displayed value to the actual test weight value. Increase the flashing digit by pressing the UNITS key. Decrease the flashing digit by pressing the ZERO key. Pressing the PRINT key or the TARE key will change the position of the flashing digit.
4. After entering the exact value, press the NET/GROSS key to save the value. If the C1 calibration was successful, the display will show "**EndC1**" momentarily, followed by "**C 2**" for the second calibration point.
5. Repeat steps 2 thru 4 for C2 and C3. At the conclusion of C3, the indicator reverts back up to F17. **NOTE:** If you wish to use only one calibration point (C1), simply press the NET/GROSS key when prompted for C2 and C3 (do not enter in a calibration value).

- At this time it is suggested that the calibration values be recorded for future use (see next section).

If the calibration was *not* successful, one of the error messages below will appear. Take the indicated action to correct the problem, then perform a new calibration.

"Err0" - The calibration test weight or the keyed-in weight is larger than the full capacity of the scale. Change the calibration test weight or check the input data.

"Err1" - The calibration test weight or the keyed-in weight is smaller than 1% of the full capacity of the scale. Change the calibration test weight or check the input data.

"Err2" – There is not enough signal from the load cells to establish a proper calibration. Most commons causes include incorrect load cell wiring, a mechanical obstruction or a faulty load cell.

VIEW CALIBRATION VALUES (F18)

Note: The values displayed in this procedure are valid only after a successful calibration has been performed using F16 and F17.

- While in the Setup mode, scroll to **"F 18"**, then scroll down once using the ZERO key to enter View calibration menu.
- The display will show the information listed in Table 2. The code will display briefly followed by the value. It is recommended that you record each value in the table below. Press any key to continue down the list. At the completion of the list, the indicator reverts back up to F18.

CODE	NAME	VALUE
C 0	Zero Calibration Value	
T 1	First Test Weight Value	
C 1	First Span Calibration Value	
T 2	Second Test Weight Value	
C 2	Second Span Calibration Value	
T 3	Third Test Weight Value	
C 3	Third Span Calibration Value	

Table 2: Calibration Value Table

KEY-IN ZERO CALIBRATION VALUE (F19)

Note: This procedure is intended for emergency use only in the case of non-volatile memory loss. A valid zero calibration value, obtained from a successful F16 calibration procedure, must be used.

1. While in the Setup mode, scroll to "**F 19**", then scroll down once using the ZERO key. The display will momentarily show "**ET C 0**", followed by a value of zero
2. Use the four directional keys to enter in the actual zero calibration value.
3. After entering the exact value, press the NET/GROSS key to save the value. The display will show "**E E C 0**" momentarily, and then revert back up to F19.

KEY-IN SPAN CALIBRATION VALUE (F20)

Note: This procedure is intended for emergency use only in the case of non-volatile memory loss. Valid span calibration values, obtained from a successful F17 calibration procedure, must be used.

1. While in the Setup mode, scroll to "**F 20**", and then scroll down once using the ZERO key. The indicator will prompt you to enter the information in Table 3.
2. If the value shown is correct, press the NET/GROSS key to move to the next parameter. Otherwise, use the four directional keys to enter in the actual calibration value
3. After setting the exact value, press the NET/GROSS key to save the value.
4. If the entered values are entered successfully, the display will show "**E**" momentarily before continuing to the next parameter. At the completion of the sequence, the indicator will then revert back up to F20.

CODE	NAME
ET T 1	First Test Weight Value
ET C 1	First Span Calibration Value
ET T 2	Second Test Weight Value
ET C 2	Second Span Calibration Value
ET T 3	Third Test Weight Value
ET C 3	Third Span Calibration Value

Table 3: Calibration Value Entry Table

OPERATION

DISPLAY

This model utilizes a 6-digit LED (Light Emitting Diode) display. Table 4 summarizes the display annunciators.

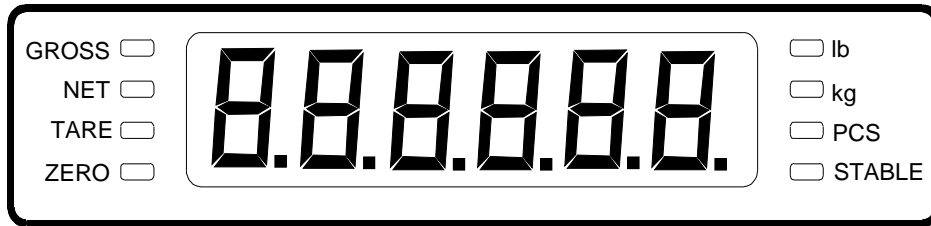

LED Annunciator	MEANING
ZERO	Better known as the “Center of Zero” annunciator, this light is active whenever the displayed weight is within a pre-programmed band from true zero.
NET	Indicates that the indicator is displaying net weight.
GROSS	Indicates that the indicator is displaying gross weight.
TARE	Indicates that a tare weight has been established in the system.
lb, kg, PCS	Indicates the unit of the displayed weight. PCS stands for “pieces”.
STABLE	This light is on whenever the scale is stable.

TABLE 4: T500ESS Annunciator Definitions

KEYBOARD

The keyboard is composed of five function keys shown below.



FUNCTION KEYS

Units – This key toggles the indicator among the available weight units if enabled in the User (“A”) menu. Available weight units include lb, kg and pieces..

Zero - This key sets the indicator to display zero provided the following conditions are met:

1. The indicator is displaying Gross weight.
2. The displayed weight is within the zero reset range that is programmed in F4 of the Setup (“F”) Menu.
3. The scale is not in motion.
4. The scale is not in overload (see Appendix D for error codes).

Net/Gross - This key toggles the indicator between Gross weight and Net weight only if a Tare has been established.

Tare - This key is used to establish a Tare provided the following conditions are met:

1. The indicator is not at or below Gross zero.
2. The scale is not in motion.
3. The scale is not in overload (see Appendix D for error codes).

Print - This key is used to send weight information out to the serial port provided the following conditions are met:

1. The scale is not in motion.
2. The scale is not in overload (see Appendix D for error codes).

GENERAL SCALE OPERATION

WEIGHING AN ITEM

1. Select the desired weighing unit by pressing the lb/kg key until that unit is indicated on the display.
2. If necessary, press the ZERO key to obtain a weight reading of zero.
3. If weighing an item in a container, place the empty container on the scale’s platter and, after allowing the weight indication to stabilize, press the TARE key. The display shows zero weight and turns the NET annunciator on
4. Place the object to be weighed on the scale’s platter and allow the weight indication to stabilize. If the item weight exceeds the scale’s weight capacity, it displays “oooooo”.
5. Read the weight shown on the display. If you have established a tare, you may toggle between the gross weight and the net weight by pressing the NET/GROSS key

PIECE COUNTING MODE

IMPORTANT NOTE: The piece counting function cannot be used in commercial (NTEP) applications.

To activate this mode, set F30 to 3. This mode is used to indicate the number of pieces of an item you have placed on the scale’s platform and is accessed by pressing the UNITS key. To ensure accuracy, the parts you are counting must be consistent in weight.

The indicator uses the sampling method to determine the average piece weight (APW) of the items you wish to count. When sampling items, always count the parts in your hand and place them on the platform all at once. If the APW of the items is too light or the total weight of the sample is too light, accuracy cannot be guaranteed. You will get an error message, but piece counting will still be allowed. This indicator does not retain the piece weight when powered down.

1. If the items you will be counting require a container, you must first tare the container off by pressing the TARE key.
NOTE: The TARE key is inoperative when in sampling mode.
2. Press the UNITS key until “5 0” is indicated on the display. If the screen does not show “5 0”, press the ZERO key once. The indicator is prompting you to place five identical items on the platform.
NOTE: If you wish to change the sample number, simply press the UNITS key repeatedly until the desired sample number appears. Available choices are 5, 10, 20, 50 and 100. If you continue to push the UNITS key, the indicator will resort back to weighing mode and you must start again from Step 2.
3. Place the sample items on the platform all at once and allow the weight indication to stabilize. Once this is done, the zero indicated after the sample number will change to a “-“. For example, “5 -“.
4. Press the NET/GROSS key to take the sample. If the sample size is large enough, the indicator now displays the number of pieces on the platform and the “PCS” annunciator is lit. If not, the indicator briefly displays “Lo” and automatically increments the sample size. Repeat Step #4 with the new sample size.
NOTE: If the indicator continues to display “Lo” even after sampling 100 pieces, the unit weight of the items you wish to count is too light for your scale to process accurately.
5. To exit the piece count mode, press the UNITS key.
NOTE: The APW will NOT remain in scale memory when you exit piece counting mode.

PEAK HOLD MODE

IMPORTANT NOTE: The peak hold function cannot be used in commercial (NTEP) applications.

To activate this mode, set F30 to 5. This mode is used to indicate and hold the peak weight recorded during a specific process. The most common application is testing the breaking point of a part or assembly.

1. Push the UNITS key to active peak hold mode; the display briefly shows “HOLD”. If the display does not show 0, then press the ZERO key.
2. Apply force to the piece – the display indicates and holds the peak force applied.
3. To reset the peak value to zero, press the ZERO key.
4. To exit peak hold mode, press the UNITS key again; the display briefly shows “-HOLD”.

REMOTE DISPLAY MODE

To activate this mode, set F30 to 2. This mode is used to emulate a remote display for a separate indicator. For it to work properly, a remote indicator must be transmitting information to the T500ESS continuously and at the same transmission (baud) rate configured in A1.

LEGAL FOR TRADE SEALING

Indicators can be sealed for commercial (Legal for Trade) applications as follows.

1. Power off the indicator.
2. On the back of the indicator, locate the setup/calibration switch cover.
3. Thread a wire security seal through both drilled head screws securing the calibration switch cover as well as the single drilled head screw holding on the rear panel.

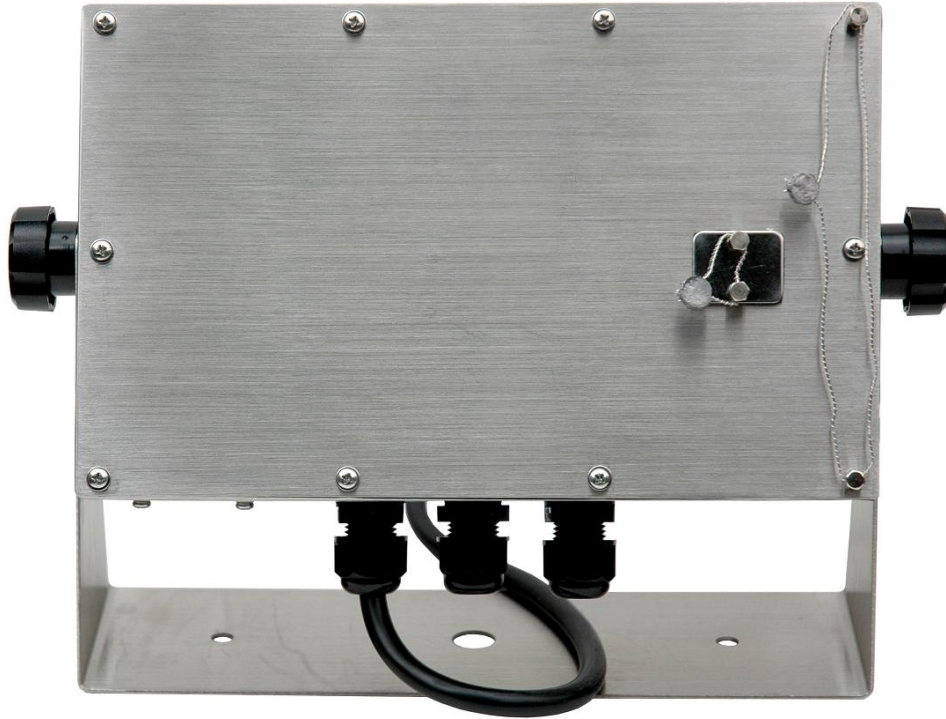

APPENDIX A: SPECIFICATIONS

ANALOG SPECIFICATIONS

Full Scale Input Signal	±3.125 mV/V
Minimum Sensitivity - Non trade	0.3 μ V / grad
Minimum Sensitivity - H-44/R76	0.6 μ V / grad
Input Impedance	30M Ω , typical
Internal Resolution	Approximately 260,000 counts @ 2mV/V input
Display Resolution	50,000 display division max
Measurement Rate	10/80 Hz, selectable
System Linearity	Within 0.02% of FS
Calibration Method	Software Calibration, with long term storage in EEPROM
Excitation Voltage	+5 VDC, 4 x 350 Ω load cells

DIGITAL SPECIFICATIONS

Microcontrollers	<ul style="list-style-type: none">• Winbond W78E58 (Standard Chipset)• Winbond W77E58 (Enhanced Chipset)
Program Memory	<ul style="list-style-type: none">• 32K x 8, internal to μC
SRAM:	<ul style="list-style-type: none">• 512 x 8, internal to μC (Standard Chipset)• 1024 x 8, internal to μC (Enhanced Chipset)
EEPROM:	256 x 8, external to μ C
Digital Filtering	Software selectable

SERIAL COMMUNICATIONS

Serial Port	Full Duplex, selectable Baud rate
	8 data bits, no parity, 1 stop bit
	7 data bits, odd parity, 1 stop bit
	7 data bits, even parity, 1 stop bit
	7 data bits, no parity, 2 stop bits

OPERATOR INTERFACE

Display – LED Indicators	0.56" (14 mm) 7-segment, LED, 6 Digit
Additional Symbols	Net, Gross, Stable, Tare, lb, kg, Zero, PCS
Keyboard	5-key flat membrane panel

POWER

T500ESS	100-240 VAC, 50/60 Hz, 30W
DC Power Consumption	80mA + 30mA/350 Ω Load Cell

ENVIRONMENTAL

Operating Temperature	-10° to +40° C
Storage Temperature	-25° to +70° C

MECHANICAL

Overall Dimensions (L x W x H)	10.4" x 3.1" x 7.7" (265mm x 80mm x 195mm)
--------------------------------	--

APPROVALS

NTEP	COC # 96-028
------	--------------

APPENDIX B: SERIAL PORT INFORMATION

SERIAL PORT MODES

DEMAND DUPLEX MODE

The Demand Duplex Mode provides a two way serial transmission mode. In this mode, the output information is transmitted on demand; either by pressing the PRINT key on the indicator's front panel or upon receiving a recognized command from a host device (i.e. computer).

NOTE: Ensure that your cabling contains the proper handshaking.

CONTINUOUS DUPLEX MODE

The Continuous Duplex Mode provides a two-way serial transmission mode. In this mode, the output information is transmitted continuously making it a popular choice for remote displays and other remote devices requiring a constant data stream. The transmission automatically occurs at the end of each display update. The indicator will react upon receiving a recognized command from a host device.

RECOGNIZED HOST COMMANDS (applies to both demand and continuous duplex modes)

- “P” - This command is sent to the indicator to print the indicated display. The indicator will not respond if the scale is in motion, positive overload or negative overload.
- “Z” - This command is sent to the indicator to zero the scale. The indicator will not respond if the scale is in motion, positive overload or negative overload. The indicator will also not respond if it is not in gross mode or within the zero range specified in F4 of the Setup Menu.
- “T” - This command is sent to the indicator to tare the scale. The indicator will not respond if the scale is in motion, positive overload or negative overload. The indicator will also not respond if it displaying a negative gross value.
- “G” - This command is sent to the indicator to switch to gross mode. The indicator will not respond if the scale is in motion, positive overload or negative overload.
- “N” - This command is sent to the indicator to revert to net. The indicator will not respond if the scale is in motion, positive overload or negative overload. The indicator will also not respond if a tare has yet to be established.
- “C” - This command is sent to the indicator to toggle among the configured units of measure.

AUTO PRINT MODE

The Auto Print Mode provides a one-time serial transmission once a non-zero, stable condition is achieved.

OUTPUT STRINGS

TEXT PRINT TICKET

The Text Print Ticket is designed specifically for a serial printer.

ID. NO.	123456
GROSS	25.00 LB
TARE	1.48 LB
NET	23.52 LB

NOTES:

1. The TARE and NET fields are not printed unless a tare has been established in the system.
2. The ID number field is not printed if it is disabled in A7 of the User Menu.

STRING FORMAT 1 (Condec Demand String)

String Format 1 is designed for two-way communication.

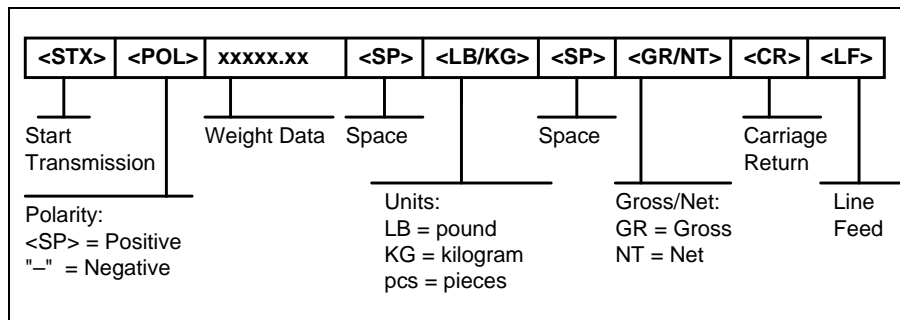

STRING FORMAT 2 (Condec Continuous String)

String Format 2 is designed for one-way communication.

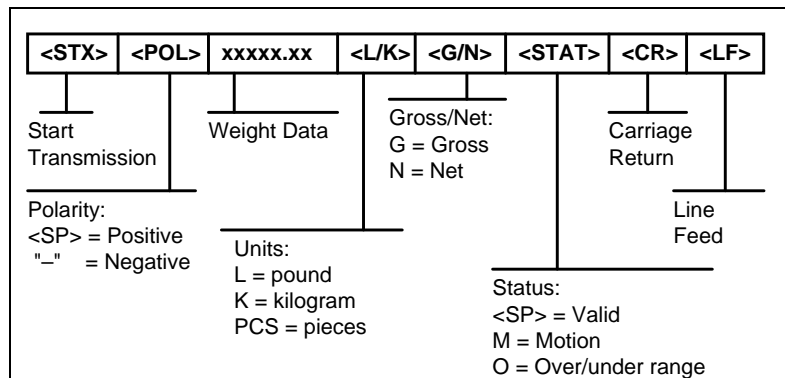

APPENDIX C: DISPLAYED ERROR CODES

CODE	MODE	MEANING / POSSIBLE SOLUTION
□□□□□□	Normal Operating Mode	Gross Overload. A weight greater than the rated capacity has been applied to the scale. Remove the weight from the platter or try re-calibrating the scale. Otherwise, check for a bad load cell connection or possible load cell damage due to overloading.
Err 0	Span Calibration Mode (F17)	Keyed-in weight value is larger than full-scale capacity. Use a smaller test weight or check keyed-in value.
Err 1	Span Calibration Mode (F17)	Keyed-in weight value is less than 1% of full-scale capacity. Use a larger test weight or check keyed-in value.
Err 2	Span Calibration Mode (F17)	There is not enough load cell signal to produce the internal counts necessary to properly calibrate the scale. First check all load connections. Use F16 mode to view internal counts.
Err 3	All Modes	Non-volatile memory read error. One or more setup parameters have been lost.
Err 4	All Modes	Non-volatile memory write error. Indicator needs service.
Err 5	Key-in Span Calibration Mode (F20)	You have attempted to enter a zero value for C1-C3. Enter a known calibration value greater than zero.
Err 9	Normal Operating Mode	Span calibration value has been lost. Re-calibrate the scale.