

T7- S7

T-Touch All in One Application

Technical Manual



CONTENTS

1. Specifications.....	2
1.1. General.....	2
1.2. Analog Input.....	2
2. Installation.....	3
2.1. Requirements.....	3
2.2. Installation Ports.....	3
2.3. Load cell Connection.....	4
2.4. RS-232 Connection.....	5
2.5. Power.....	6
3. Operation.....	7
3.1. Basic Operation.....	7
3.2. Panel key Functions.....	7
3.3. Touch Key Functions.....	8
3.4. Indications.....	9
3.5. On-Screen Key Board.....	10
4. Application Operation.....	11
4.1. Class Operation.....	11
4.2. Take Out Operation.....	17
4.3. Target Operation.....	19
4.4. Counting Operation.....	21
4.5. Check Weighing Operation.....	24
5. Menu Settings.....	26
5.1. Settings.....	26
5.1.1. Basic Information.....	26
5.1.2. System Settings.....	27
5.1.3. Weighing Setting.....	29
5.1.4. Operating Setting.....	32
5.1.5. Calibration.....	34
5.1.6. Communication.....	36
5.2. Accumulation Operation Settings.....	36
5.3. Total Operating Settings.....	37
5.4. Take Out Operating Settings.....	37
5.5. Format Operation Settings.....	37
5.6. Data Export Settings.....	38
5.7. Help Settings.....	38
6. Error Message.....	39

INTRODUCTION

The 5 in 1 application is designed for multiple use, such as CLASS weighing, Take Out Operation, Target Operation, Counting and Check weighing. This application can use for all of the T Touch products.

1. SPECIFICATIONS

1.1. General

Capacity	Free setting
External Resolution	6000e
Tare range	Max-1d
AD Type	Sigma delta
AD Speed	Max. 60 times/second
Internal Counts	1,000,000
Weighing Units	kg, g, tj, gj, lb, oz, lz
Calibration Unit	kg, g, lb (lb only for NTEP model)
Load Cell Excitation	5VDC
Input Signal Range	0~20mv
Zero Point Signal Range	0~5mv
Load cell Sensitivity	1mv/v~3mv/v
Load cells	4 x 350 ohm load cells.
Operation Temperature	-10~40C
Operation Humidity	<95%
Display	7" TFT LCD or above
Display resolution	800x480
Display H/V ratio	16:9
Touch Control Mode	Resistance Screen
Communication Interface	1xRS-232、1xUSB or above
Optional interface	Wifi、
CPU	CORTEX
RAM	128MB DDR
Data memory	256MB NAND flash
Power	AC Adapter 12V/2500mA or main power 110V/220V

1.2. Analog Input

Load Cell Excitation	±5VDC
Connection	4 wire or 6 wire; 4 x 350 ohms
A/D Converter	Sigma Delta

2. INSTALLATION

2.1 Requirements

The mounting location must be a stable surface and free of heat, water and humidity.

The Indicator should be placed convenient and easy operation.

2.2 Installation Ports of T7

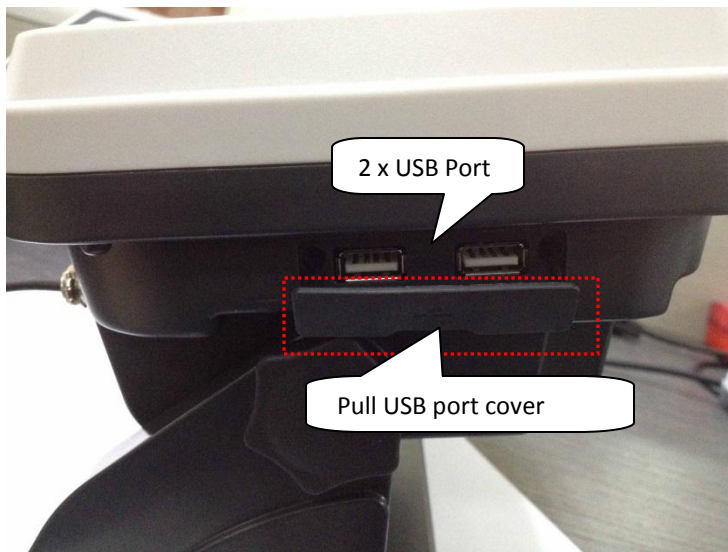

2.2.1 Installation Ports of S7

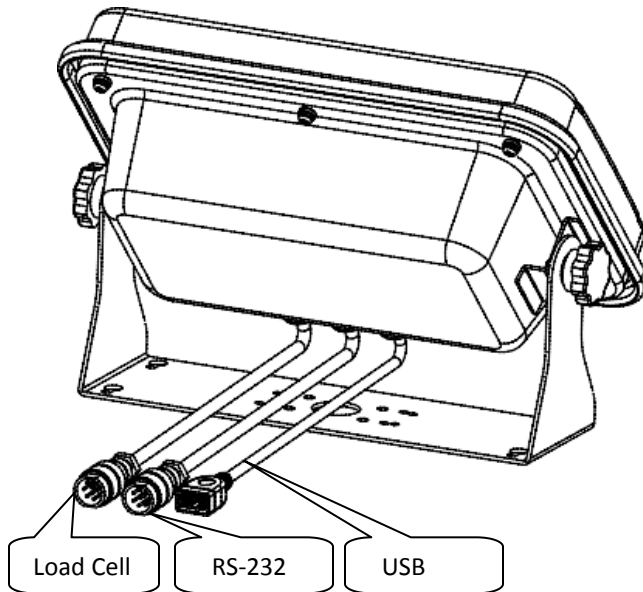

2.3 Load Cell Connection

5 Pin Air Connector



Pin	Connection	AD - PCB Connection Wire Color
1	Signal +	Green
2	Signal -	White
3	Shield	Blue
4	Excitation -	Black
5	Excitation +	Red



Note: if using 7 wire load cell, please short-circuit SEN+ to EXC+, and SEN- to EXC- for to connect

2.4 RS-232 Connection

The RS-232 port is located on the side or rear of the scale (refer to component description). It is a DB9 (T 7 Indicator) and Round Air (S 7 Indicator) connector, and its signals are defined in the following.

Pin 2 : RXD
Pin 3 : TXD
Pin 4 : VCC
Pin 5 : GND

Serial Interface: Scale – PC / Printer connection:

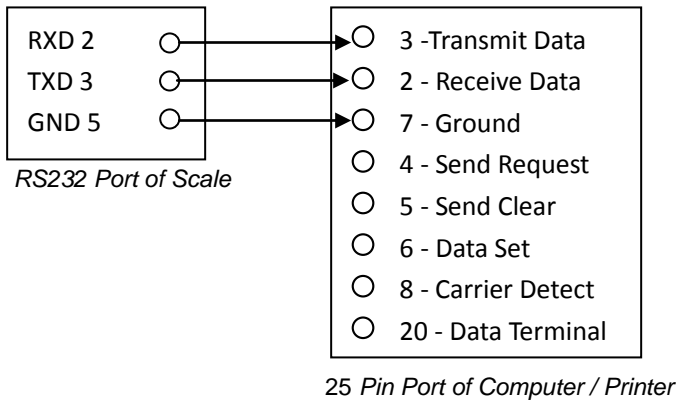
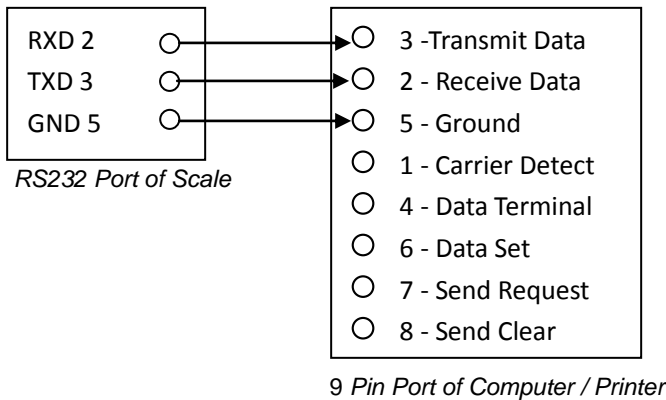

2.5 Power

The power supply accepts the voltage of charger 12VDC/2500mA from the external power adaptor with input from 100~240 VAC 50/60 Hz.

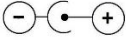
Adaptor polarity should be 



Battery:

The Indicator can optionally be operated from the internal rechargeable battery 6V/4Ah.

Connect Adaptor and Charging:

To charge the battery, insert the adaptor pin to the jack. Adaptor simply plug into the mains power.

The scale no needs to be turned on, The battery should be charged for 12 hours for full capacity.



Right down side of the keyboard there is an LED to indicate the status of battery charging. When the scale is plugged into the mains power the internal battery will be recharged. If the LED is green, the battery has a full charge. If it is red, the battery is nearly discharged.

Do not use any other type of power adaptor than the one supplied with the scale.

Verify that the AC power socket outlet is properly protected.

Note: Charge the battery before using the scale for the first time.

3. OPERATION

3.1 Basic Operations

3.1.1 Power on

Press and hold  key until to hear a beep sound. It will take around 30 seconds for to run the TOS operating system and application software.

3.1.2 Standby

Press  key for to keep display standby / sleep. Press ON/OFF key again for to turn on the display.





3.1.3. Power off

Press and hold  key until to show a Power Off window. Touch option YES to power off or NO to back to use.

3.1.4. Reboot









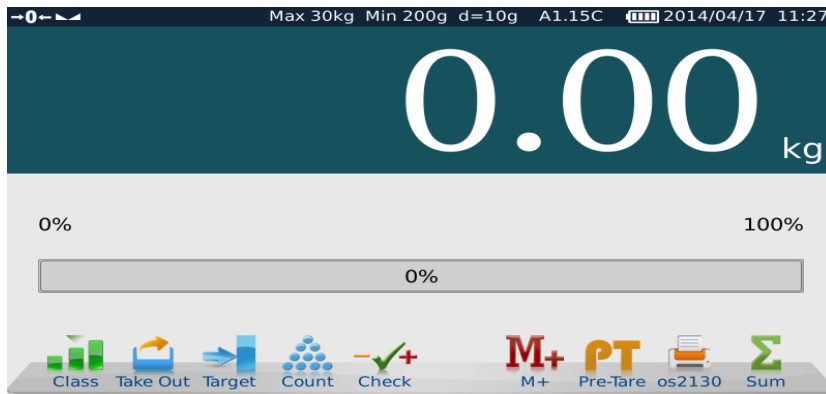

Hold  key 10 seconds, the system will reboot to recover from abnormal situation.

3.2. Panel Key Functions

Keys	Description
	Press key for to turn to power ON, power OFF, standby and system restart
	Press key for to go to the menu operation, a menu table will be show at the bottom of the display.
	Press key 3 seconds from any 5 in 1 operation can get back to home display If select any one of the application and if in any other settings mode, Press key once to go back to that application
	Press key for to tare the scale. The weight that was displayed will be store as the tare value and that value will be subtracted from the measurement, leaving zero on the display. The "Net" indicator will be on.
	Press key to set the reading to zero (within the allowed range of 2%max). Usually it's required only when the platform is empty. When the zero point is obtained, the zero indication will be show

3.3 Touch Key Functions



Keys	Description
	Class Simple weighing
	Takeout
	Target.
	Count
	Check
	Accumulation
	Pre-Tare
	Print
	Sum Details
	Load Operation
	Unload Operation



3.4 Indications

Indications	Description
	when the scale back to zero or by pressing key
	When Tare, by pressing key
	When the scale is in stable.
Max 30kg	Maximum capacity of the scale
Min 200g	Minimum weight of the scale
d=10g	Division of the scale
A1.14.01	Software version
	Battery status
2014/04/03 17:48	Date and time
T 1.83kg	Tare value

3.5 On-Screen Keyboard

On-Screen Keyboard will be open automatically for to edit or input new data, If close key board, by clicking required space to input data, it will open again.





 : Backspace

 : When input text, use this key to change line

 : Special symbols and numeric keys.

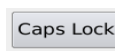
 : Close Key Board

 or  : Shift to Capital letter / small letter.

4. APPLICATION OPERATION

4.1 Class Operation

Class operation can use for goods packing, it can define different grade depend the weight for packing. It can set up to 5 different grade as A, B, C, D and E

Each grade can setup high - low limits, during the operations it will count and show totals in the each grades. It will helpful for to define the weight grade for packing.

Press  key, from the home display, display will be show class operation window



4.1.1. Product ID Search / Add / Edit

Add Product ID

Press  key, display will be show



Press Add key,

Display will be show product setting window and on-screen key board.



Input product details and select Save key. Product name will be displayed.

It can add up to 9999 products.

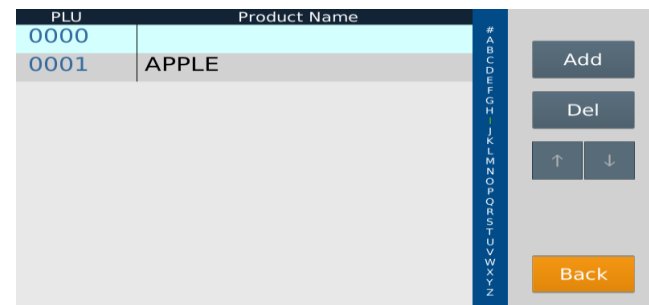

Product Search:

1) By using  keys can scroll display up and down.

2) By touching alphabetic keys can search product name

3) By sliding page up or down can change product name page



Note: Product ID Search / Add / Edit operation will be same in all applications (Class / Target / Takeout / Count / Check Weigh).

4.1.2. Class Low & High Limit Settings

Select Product from the product list, display will be show 5 different class as empty.

5 Different classes



Press one of the class to input Class Limits.

Press here



Low Limit Settings

Display will be show low limit settings,

Input limit value and press OK key



High Limit Settings

Once finish low limit setting and by pressing OK key to confirm, display will be show Hi limit settings.

Input limit value and press OK key to confirm



Display will be show the limit A and will show accordingly Lo Limit and High Limit values



As per above Low & High limit settings, it can set up to 5 different class limits. See picture below,



By pressing the Class, it can view the limits accordingly.

4.1.3. Accumulation & Class Checking

Place the goods on the platform,

Weight display will be show the weight,

Class level will be active and will be displayed the active class limits.

Press **M+** key to save; data will be save into the memory and follow long beep.

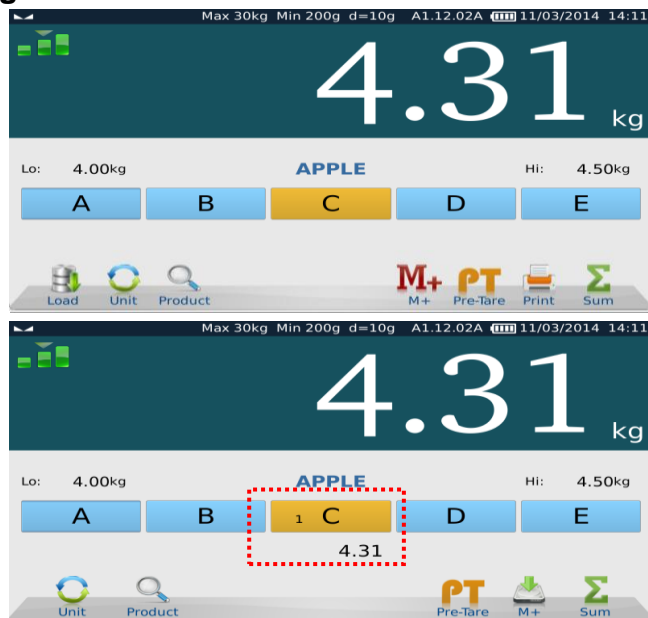

Display will show the number of times and total of the class.
 If it's different class operations, it will show accordingly for the each number of the class and total.

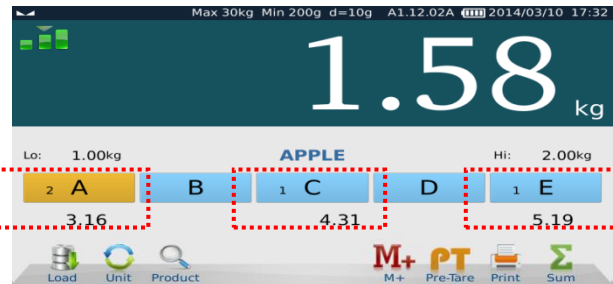
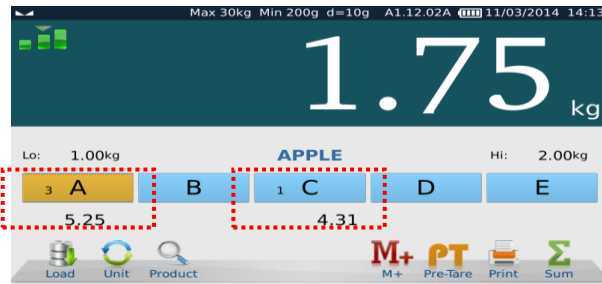

Total Accumulation

Press  key to view the total accumulation, display will be show

By using  keys can scroll display up and down.

No.	Product	Weight	Piece	Result	Time
8	APPLE	0.88		NG	17:30
9	APPLE	1.58		A	17:31
10	APPLE	2.46		NG	17:31
11	APPLE	4.31		C	17:31
12	APPLE	5.19		E	17:31
13	APPLE	1.58		A	17:32
14	APPLE	1.59		A	11:15
15	APPLE	4.35		C	11:16
16	APPLE	1.62		A	11:17
17	APPLE	4.35		C	11:17
18	APPLE	4.31		C	14:11
19	APPLE	1.75		A	14:12
20	APPLE	1.75		A	14:12
21	APPLE	1.75		A	14:12
22	APPLE	1.75		A	14:25

Count: 22 Weight: 62.78 kg Qty: 0 pcs 2/2

Memory Clear

Press  key to clear all displayed accumulation data.

Print data

Press  key for to print data, if the receipt format is selected and ticket printer is connected and selected as default settings.

Print & Memory Clear

Press  key to print and clear all accumulated data from the display.

Note:  operation will be same in all applications (Class / Target / Takeout / Count / Check Weigh).

4.1.4 Printer Operation.

Press  key to print current data.



If Print key shown  ; Communication settings not selected for the mode of printer operation.

If select communication settings, mode of printer OS 2130, printer key will be show 

Note: Printer operations will be same in all applications (Class / Target / Takeout / Count / Check Weigh).

4.1.5. Load & Unload Operation.

Load Operation

Press  key to show “Load” for load operation, By loading goods class limits will be show the limits

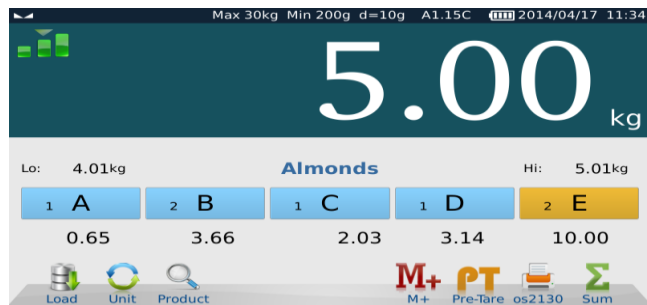

Unload Operation

Press  key , it will change to  key for unload operation.

Place the goods box on the platform and unload goods from the box,

Class limits will be show accordingly unloaded goods weighing limits.



4.1.6 Pre -Tare

Press  key, display will be show

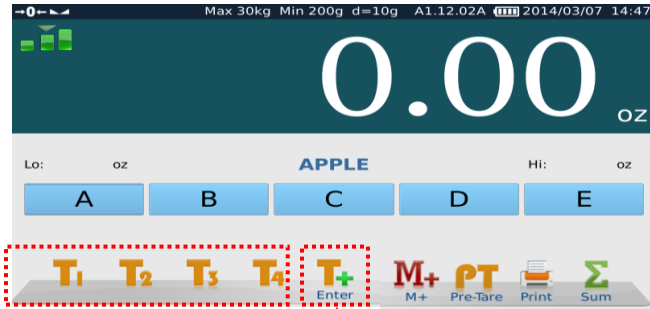

Pre-Set Tare Keys

Pre-Tare Direct input Key

Pre-Set Tare Keys

Four different known Tare weight can be store into the Pre-Set Tare keys.

Press and hold Pre-Set Tare key 3 seconds, display will be show numeric keys to input tare value.

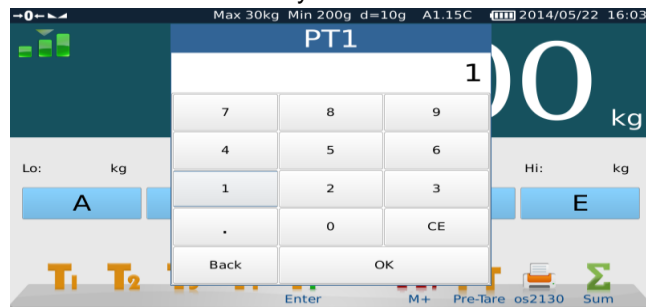

Input Tare value and press OK to confirm, display will be show tare value below of the key.



Re-call Pre-Set Tare value, press pre

saved tare key  display will be show in minus as tared value.



Note: Pre-Tare  operations will be same in all applications (Class / Target / Takeout / Count / Check Weigh).

4.2 Take Out Operation

Press  key, from the home display, display will be show

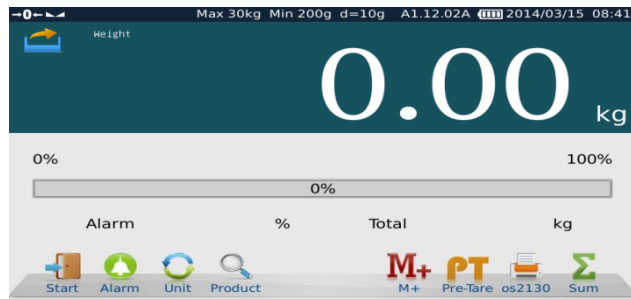

Set alarm for Take out operation.

Press  key, display will show to input alarm percentage.

Input alarm (it will be show as percentage), and press OK to confirm.



Place the goods on the pan and press  key to start and set the load as 100 %.

Display will be show the graph 100 % and red color will be displayed as alarm value.



Remove the goods from the pan and press



key, Removed goods weight will be show in extracted window

It can follow to remove goods and by pressing



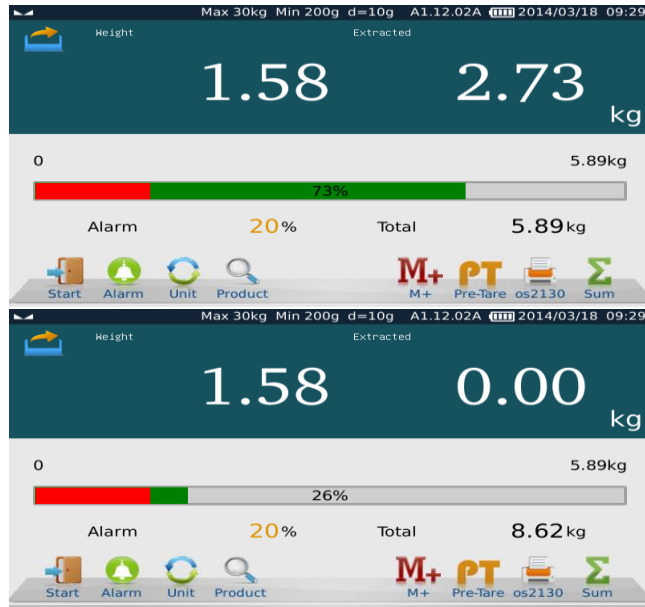

key to save memory. It will be extracted and will start to beep once reach the alarm value.



Note: Take out operation auto / manual can select from the settings.

Total Accumulation

Press  key to view the total accumulation, display will be show

By using   keys can scroll display up and down.

No.	Product	Weight	Piece	Result	Time
8	APPLE	0.88		NG	17:30
9	APPLE	1.58		A	17:31
10	APPLE	2.46		NG	17:31
11	APPLE	4.31		C	17:31
12	APPLE	5.19		E	17:31
13	APPLE	1.58		A	17:32
14	APPLE	1.59		A	11:15
15	APPLE	4.35		C	11:16
16	APPLE	1.62		A	11:17
17	APPLE	4.35		C	11:17
18	APPLE	4.31		C	14:11
19	APPLE	1.75		A	14:12
20	APPLE	1.75		A	14:12
21	APPLE	1.75		A	14:12
22	APPLE	1.75		A	14:25

Count: 22 Weight: 62.78 kg Qty: 0 pcs 2/2

Memory Clear

Press  key to clear all displayed accumulation data.

Print data

Press  key print data.

Print & Memory Clear

Press  key to print and clear all accumulated data from the display.

4.3 Target Operation

Press  key, from the home display, display will be show Target operation window



Press  key to select product name from the list,

Press  key to select target, display will be show numeric keys to input target value.

Input target value and press OK to confirm.



Accumulation Operation:

Place the goods on the pan and follow to press

 key to save. Target graph will increase accordingly.



This operation can be continue to reach the target value,

Target graph will be increase and will change color once reach the target.

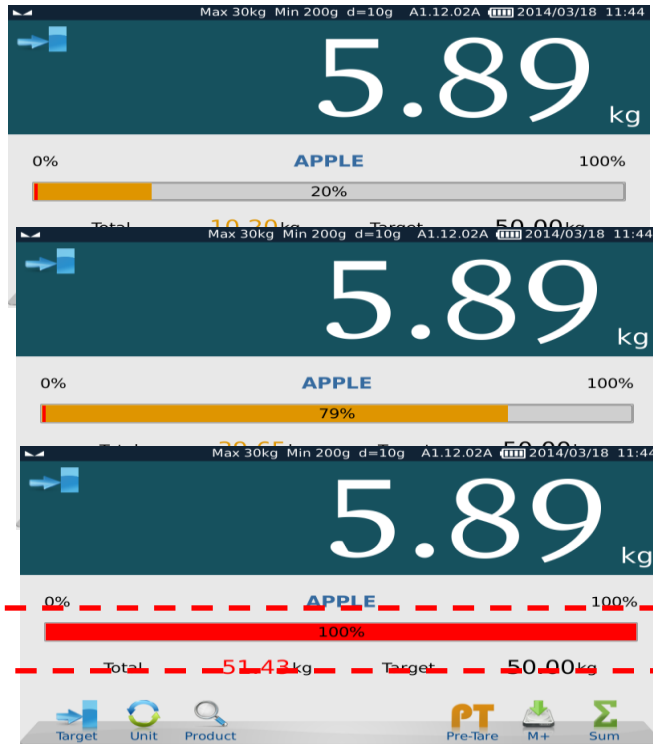

Total weight value and graph will be change

accordingly once press  key.

Total Accumulation

Press  key to view the total accumulation, display will be show

By using   keys can scroll display up and down.

No.	Product	Weight	Piece	Result	Time
8	APPLE	0.88		NG	17:30
9	APPLE	1.58		A	17:31
10	APPLE	2.46		NG	17:31
11	APPLE	4.31		C	17:31
12	APPLE	5.19		E	17:31
13	APPLE	1.58		A	17:32
14	APPLE	1.59		A	11:15
15	APPLE	4.35		C	11:16
16	APPLE	1.62		A	11:17
17	APPLE	4.35		C	11:17
18	APPLE	4.31		C	14:11
19	APPLE	1.75		A	14:12
20	APPLE	1.75		A	14:12
21	APPLE	1.75		A	14:12
22	APPLE	1.75		A	14:25

Count: 22 Weight: 62.78 kg Qty: 0 pcs 2/2

Memory Clear

Press  key to clear all displayed accumulation data.

Print data

Press  key print data.

Print & Memory Clear

Press  key to print and clear all accumulated data from the display.

4.4 Counting Operation

Press  key, from the home display, display will be show counting / Sampling operation window

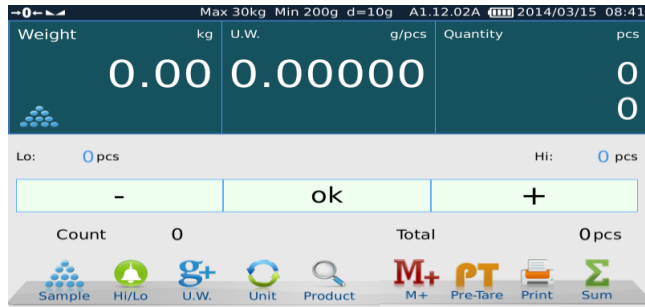

Sampling / counting operation

Select  key display will be show direct sampling keys.



Direct sampling keys x5 , x10 and x20

Sample Enter key

Direct Sample:

Place the goods on the pan and press direct sample key, quantity display will be show accordingly x5/ x10/ x20 and U.W display will be show according to the unit weight.



Input Sample:

Place the goods on the pan and press sample enter key, display will be show numeric key to input sample.

Input sample and press OK key to confirm, quantity display will be show accordingly the input value and U.W display will be show according to the unit weight.



High –Low Limit Operation:

Press  key or press directly to Lo or Hi windows

Press to input Hi-Low key

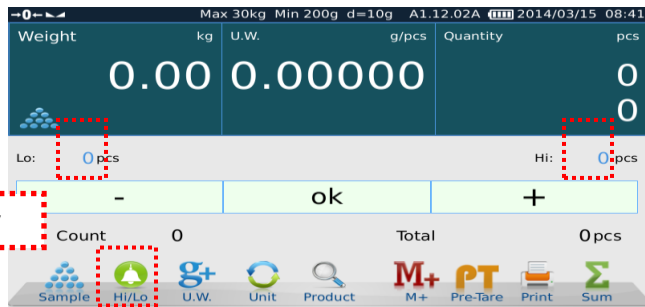

Input Low limits

Input High Limits

Low Limit Display, below the limit



Ok display, between the limits



High Limit display, exceed the limit





Accumulation

Weighing data can save by pressing  key to the memory. Total window will be show the Total and count window will be show the times of accumulation.



Total Accumulation

Press  key to view the total accumulation, display will be show

By using  keys can scroll display up and down.

No.	Product	Weight	Piece	Result	Time
8	APPLE	0.88		NG	17:30
9	APPLE	1.58		A	17:31
10	APPLE	2.46		NG	17:31
11	APPLE	4.31		C	17:31
12	APPLE	5.19		E	17:31
13	APPLE	1.58		A	17:32
14	APPLE	1.59		A	11:15
15	APPLE	4.35		C	11:16
16	APPLE	1.62		A	11:17
17	APPLE	4.35		C	11:17
18	APPLE	4.31		C	14:11
19	APPLE	1.75		A	14:12
20	APPLE	1.75		A	14:12
21	APPLE	1.75		A	14:12
22	APPLE	1.75		A	14:25

Count: **22** Weight: **62.78** kg Qty: **0** pcs 2/2

MC
Print
Print-MC
↑ ↓
Back

Memory Clear

Press  key to clear all displayed accumulation data.

Print data

Press  key print data.

Print & Memory Clear

Press  key to print and clear all accumulated data from the display.

4.5 Check Weighing Operation

Press  key, from the home display, display will show check weighing operation window.



High –Low Limit Operation:

Press  key or press directly to Lo or Hi windows

Press to input Hi-Low key



Input Lo – Hi limits and press OK to confirm,



Low Limit Display, below the limit



Ok display, between the limits



High Limit display, exceed the limit



Accumulation

Weighing data can save by pressing **M+** key to the memory. Total window will be show the Total and count window will be show the times of accumulation.

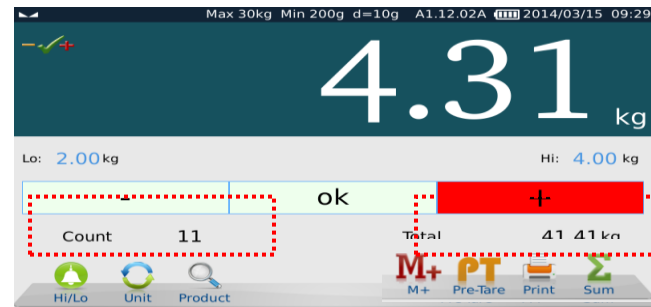

Total Accumulation

Press **Σ** key to view the total accumulation, display will be show



By using **↑** **↓** keys can scroll display up and down.



No.	Product	Weight	Piece	Result	Time
8	APPLE	0.88		NG	17:30
9	APPLE	1.58		A	17:31
10	APPLE	2.46		NG	17:31
11	APPLE	4.31		C	17:31
12	APPLE	5.19		E	17:31
13	APPLE	1.58		A	17:32
14	APPLE	1.59		A	11:15
15	APPLE	4.35		C	11:16
16	APPLE	1.62		A	11:17
17	APPLE	4.35		C	11:17
18	APPLE	4.31		C	14:11
19	APPLE	1.75		A	14:12
20	APPLE	1.75		A	14:12
21	APPLE	1.75		A	14:12
22	APPLE	1.75		A	14:25

Count: 22 Weight: 62.78 kg Qty: 0 pcs 2/2

Memory Clear

Press **MC** key to clear all displayed accumulation data.



Print data

Press **Print** key print data.



Print & Memory Clear

Press **Print-MC** key to print and clear all accumulated data from the display.



5. MENU SETTINGS

Press  key, a menu bar will be show at the middle of the display.

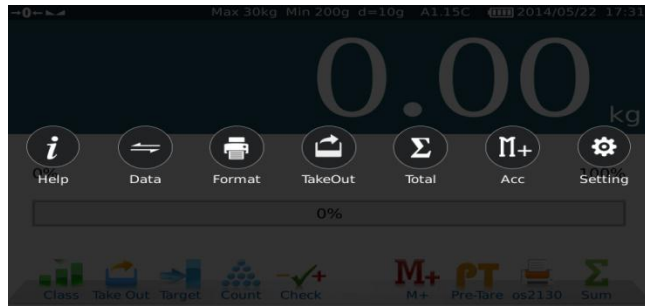

5.1. Setting

Note: During the settings it will ask password for settings, Default Settings password: 0000

Press  key to enter the parameter settings. Display will be show parameter settings.

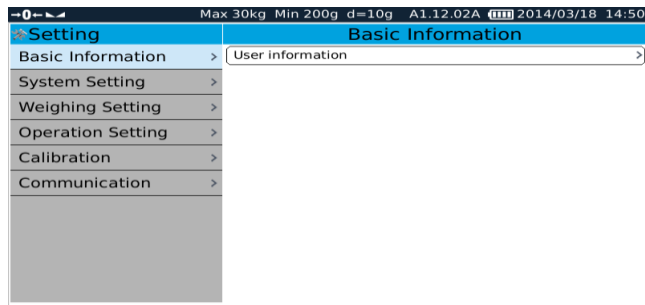

5.1.1. Basic Information

User information
Can use for print outs and all for to get customer details

Press User information to enter the details

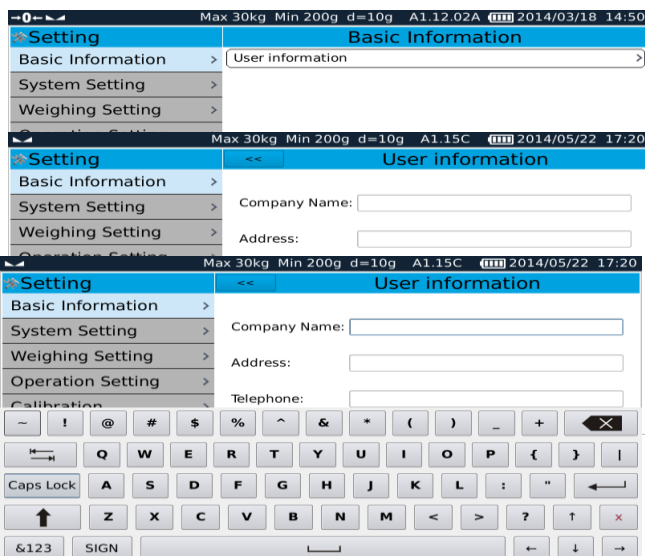



5.1.2. System settings

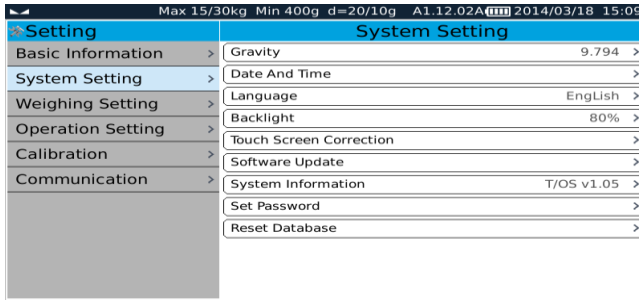

5.1.2.1. Gravity settings

Gravity can enter as per your local gravity for to avoid calibration errors.

Note: Please assure that you have input correct gravity value every time before calibration

5.1.2.2. Date and Time

It can set date and time as per the country

Enter date and time by using built-in keyboard or an outlet keyboard.

Press << key at the top of the left corner for to go back to last step, or press other options to go to next step.

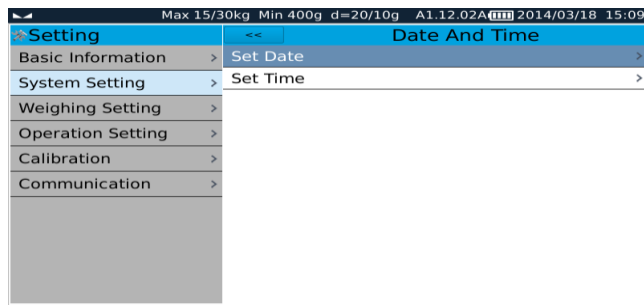

5.1.2.3. Language settings

It can change languages as per the list

Select *language from the list, confirmation display will be show, it can confirm by pressing OK and can cancel by pressing Cancel option.

If press ok, language will be change and system will restart for to change settings.

Press << key at the top of the left corner for to go back to last step, or press other options to go to next step.

*Note: If update language translated file while software updating, then only it will displayed as per the displayed other language. If you want to translate language, please contact your supplier.



5.1.2.4. Backlight

Back light can adjust as per your convenient use

Move Scroll bar left (decrease) or right (increase) for to adjust brightness of the backlight.

Press << key at the top of the left corner for to go back to last step, or press other options to go to next step.

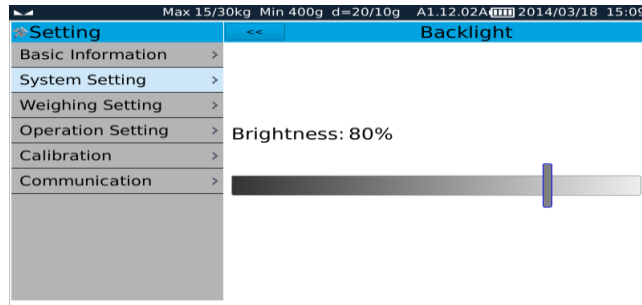

5.1.2.5 Touch-Screen Correction

Touch screen can calibrate if its required or as per your operating style.

Touch-screen correction. Confirmation pop-up will appear. Confirm to enter calibration page. A white cursor will appear in a black screen; keep clicking on the white cursors until completing the calibration process.

5.1.2.6. Software Update

System operating software can upgrade or change by using software update option.

Note: USB/Flash drive's home directory, file name should be **TscaleUpdate** and insert the flash drive into the USB port. And select software update option from the indicator for to update new software.

Software Update. A confirmation pop-up will appear; Press OK to confirm or Cancel to escape.

By pressing OK key, updating status will show and will restart once finish updation.

5.1.2.7. System Properties

It can view the software version, Operation System version, remaining storage memory, and other system information.

Press << key at the top of the left corner for to go back to last step, or press other options to go to next step.

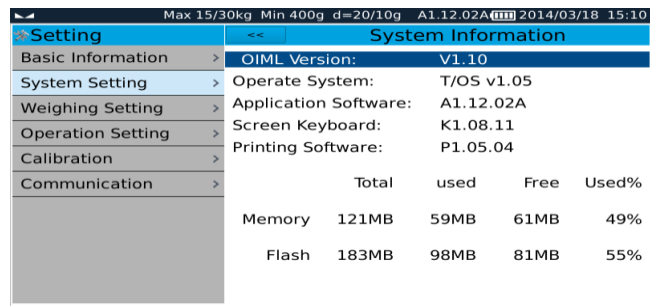

5.1.2.8. Set password

Select **Password**, it will ask security password, input default password. Then display will be show to input new password

Input new password and confirm password (re-enter new password) and Press OK to confirm or Press cancel to escape.

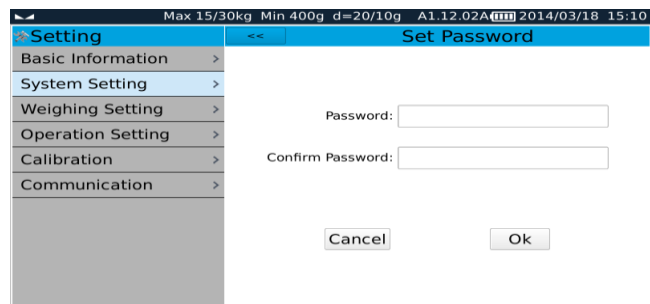

**Password is required for to access parameter settings.
Default password : 0000**

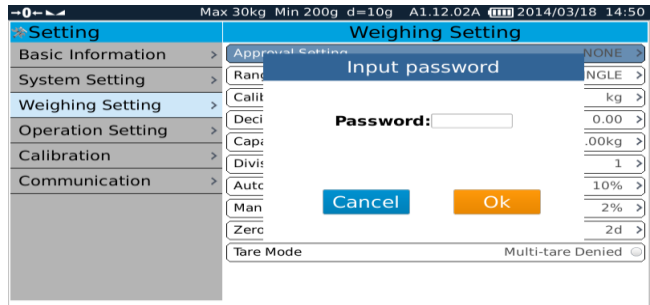

Note: If modified password, it will ask password, when want to access menu settings. And follow to use new password.

5.1.2.9. Reset database

Reset Product data, system will clear all product ID from the database.

Reset Record Data: system will clear all accumulation records from the database.

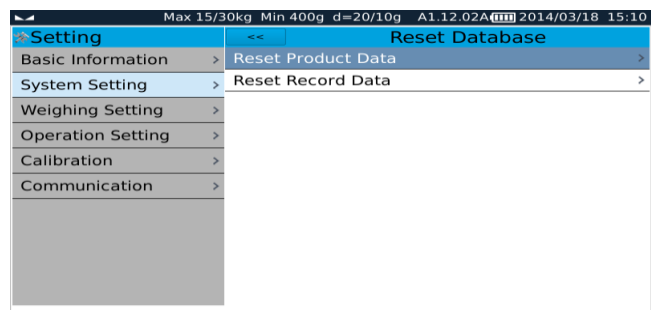

Press << key at the top of the left corner for to go back to last step, or press other options to go to next step.

Note: Please do this operation very carefully. This operation will remove all data in database, it will not recover back.

5.1.3. Weighing settings

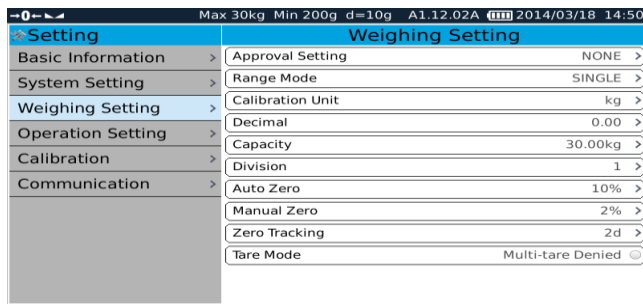

5.1.3.1. Approval setting

It can select weighing settings to None Approval / OIML Approval

Press << key at the top of the left corner for to go back to last step, or press other options to go to next step.

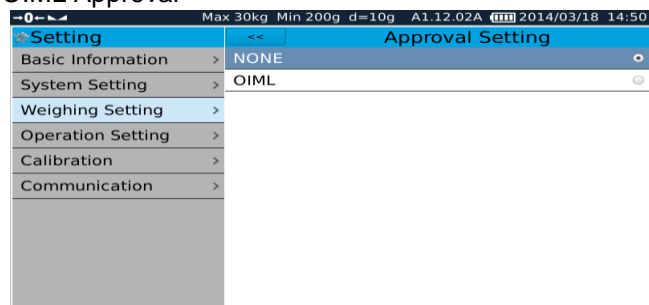

Note: If selected OIML, weighing setting functions can't access.

If want to access weighing settings, press CAL switch for to access. CAL switch is locating bottom of the housing.

5.1.3.2. Range Mode

Range mode. Can select signal range, dual interval, dual range.

Press << key at the top of the left corner for to go back to last step, or press other options to go to next step

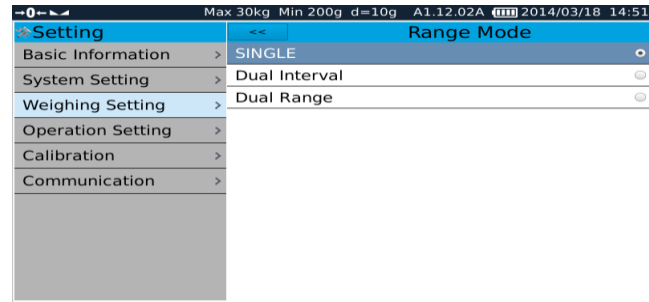

5.1.3.3. Calibration Unit

Select calibration unit from the list, kg / g / lb

It's for calibration purpose only.

Press << key at the top of the left corner for to go back to last step, or press other options to go to next step

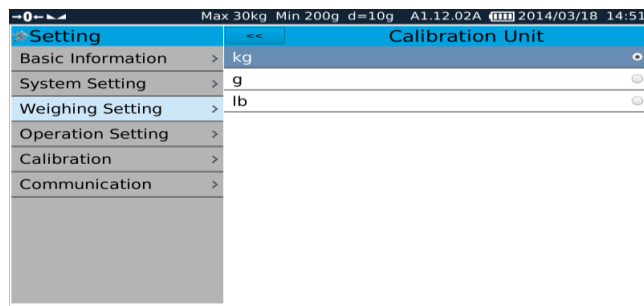

5.1.3.4. Decimal point

Select desired decimal digits from the list

Press << key at the top of the left corner for to go back to last step, or press other options to go to next step

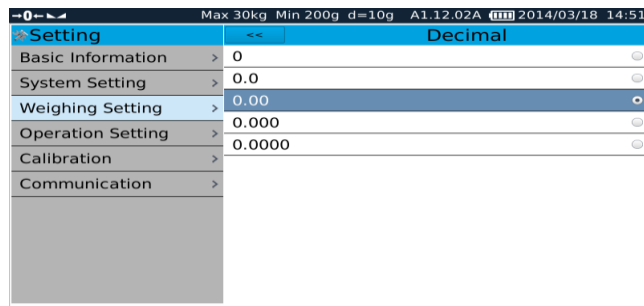

5.1.3.5. Capacity Setting

Use the numeric keypad to input capacity

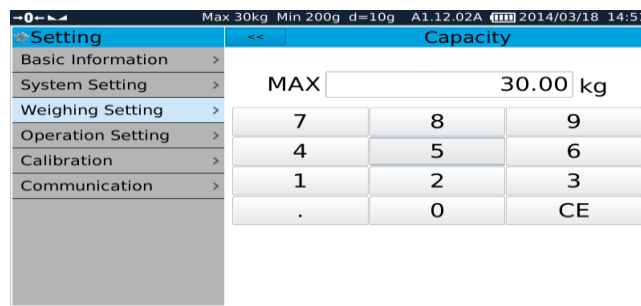

Note: If it's selected dual interval or dual range, it's required to input capacity Max1 and Max 2

It is required to set max2 > max1.

Press << key at the top of the left corner for to go back to last step, or press other options to go to next step.

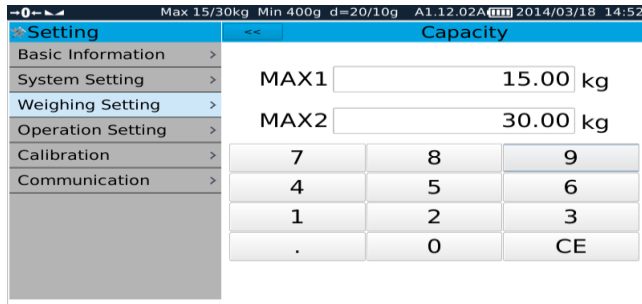

5.1.3.6. Division setting

Select the desired division from the list.

Note: If it's selected dual interval or dual range, it is required to set e2 > e1.

Press << key at the top of the left corner for to go back to last step, or press other options to go to next step

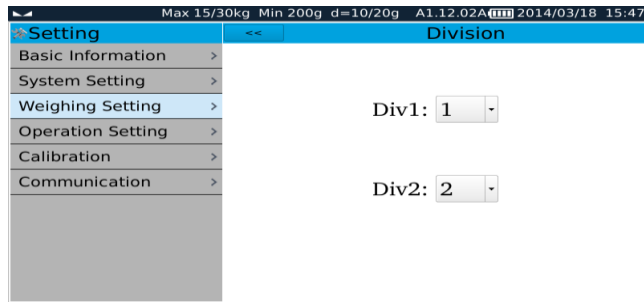
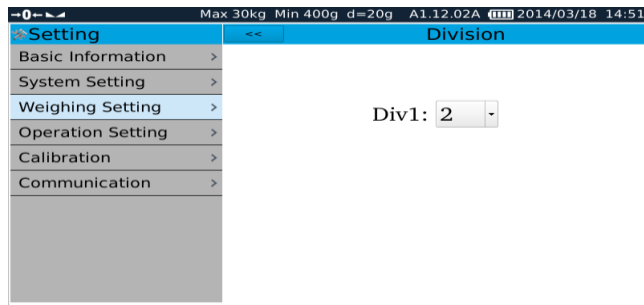

5.1.3.7. Auto zero range (initial zero)

Select the desired range from the list .

Note: This setting can't access if in approval mode.

Press << key at the top of the left corner for to go back to last step, or press other options to go to next step

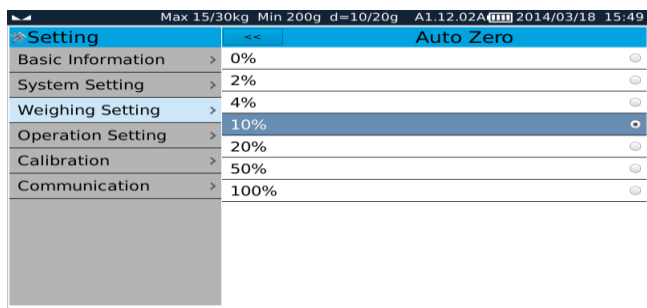

5.1.3.8. Manual Zero range

Manual Zero, Select the desired choice. Press << key at the top of the left corner for to go back to last step, or press other options to go to next step

Note: This setting can't access if in approval mode.

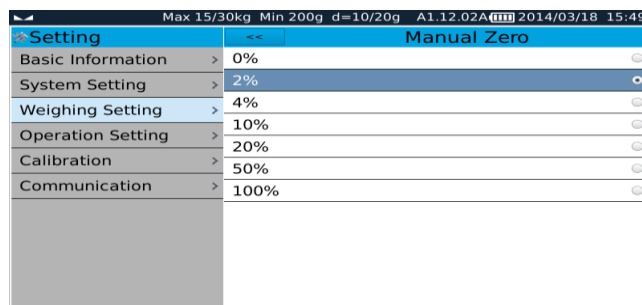

5.1.3.9. Zero Tracking

Select the desired range from the list.

Note: This setting can't access if in approval mode.

Press << key at the top of the left corner for to go back to last step, or press other options to go to next step.

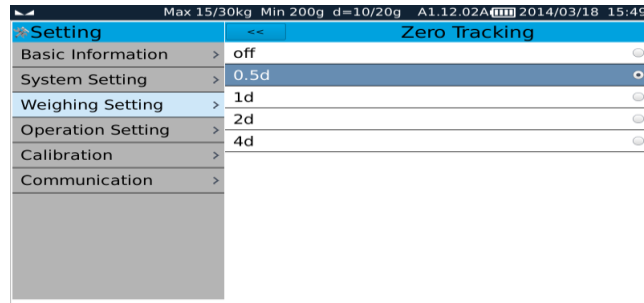

5.1.3.10. Tare Mode

Tare Operation.

Press Tare mode list to Multi-Tare Permission or Multi –Tare Disable.

Multi Tare Permission: It can do multiple tare operations.

Muti Tare Denied: One time only can do tare operation.

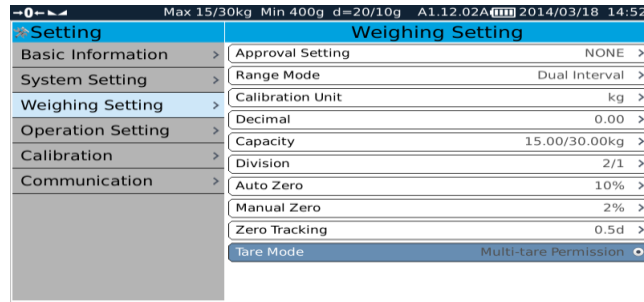

Press << key at the top of the left corner for to go back to last step, or press other options to go to next step.

Note: This setting can't access if in approval mode.

5.1.4 Operating Settings

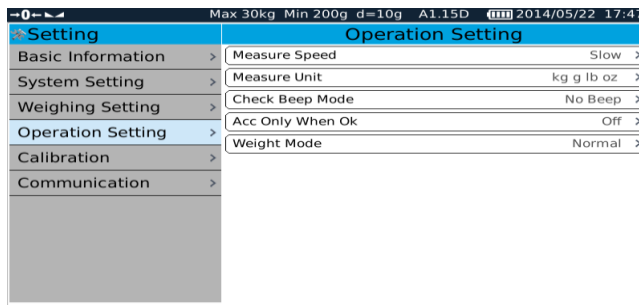

5.1.4.1. Measure speed

Select the desired Measure speed from the list, for to select for AD speed.

Press << key at the top of the left corner for to go back to last step, or press other options to go to next step.

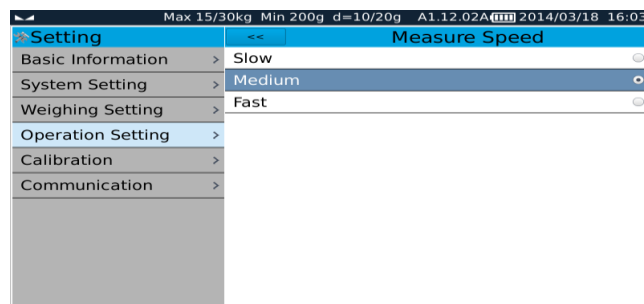

5.1.4.2 Measure Unit

Select the desired weighing unit from the list for to change weighing unit.

Press << key at the top of the left corner for to go back to last step, or press other options to go to next step.

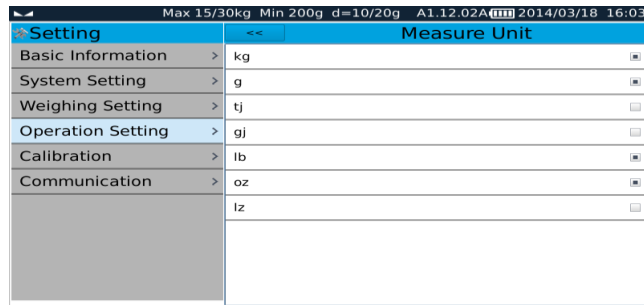

5.1.4.3. Check Beep Mode

Select check weighing alarm mode

No Beep: Buzzer will be turn off

Beep On Ok: Buzeer will beep when in between the high - low limits

Beep On Ng: Buzzer will beep when in out of the limits

Press << key at the top of the left corner for to go back to last step, or press other options to go to next step.

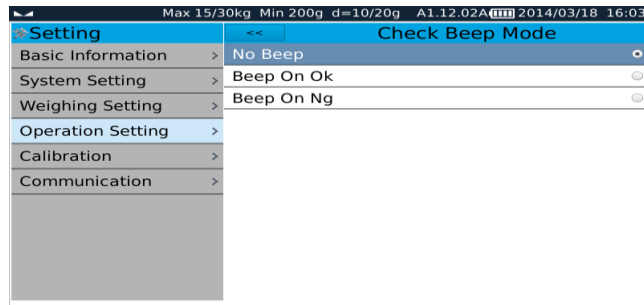

5.1.4.4. Acc Only when Ok

Acc only when Ok select to off :

If the scale is out of the Low –High limits, it can do the accumulation .

Acc only when Ok select to On :

If the scale is out of the Low –High limits, it can't do the accumulation, only can do the accumulation when between the limits.

Press << key at the top of the left corner for to go back to last step, or press other options to go to next step.

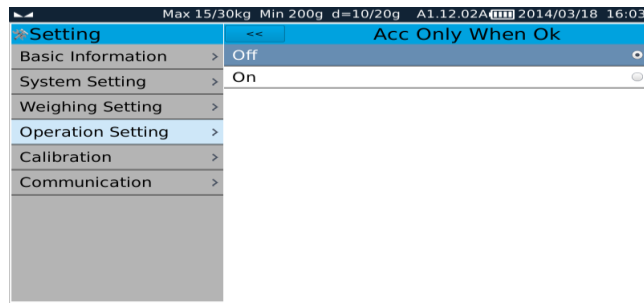

5.1.4.5. Weight Mode

Select operation to **Normal:** For normal operation

Select operation to **Auto Tare After Acc:**

By pressing **M+** key can save data to the memory and weighing value will be tared.

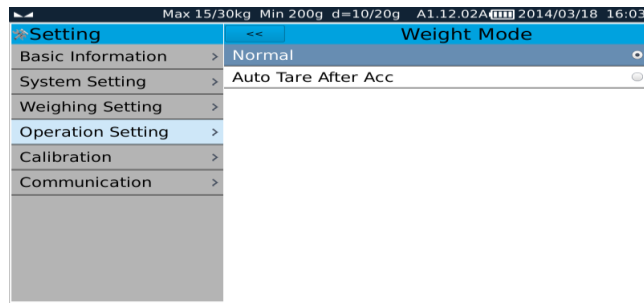

5.1.5 Calibration

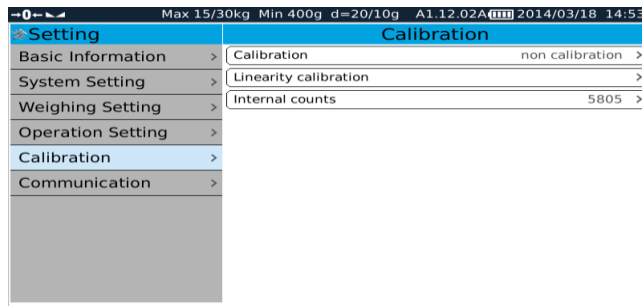

5.1.5.1. Calibration

Press START key ; Display will be show 1: Empty scale then press NEXT key option,

Keep empty platform

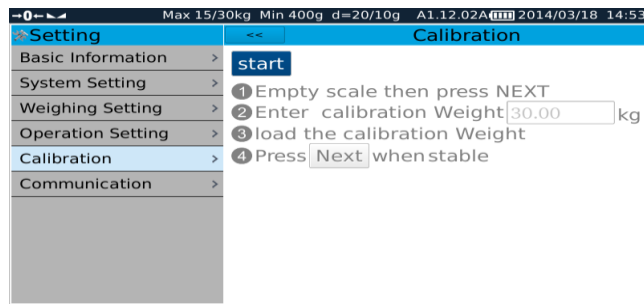

Press NEXT key,

Display will be show Previous calibration weight value and will be blink for to enter weight,

Input calibration weight value and press OK option to confirm.

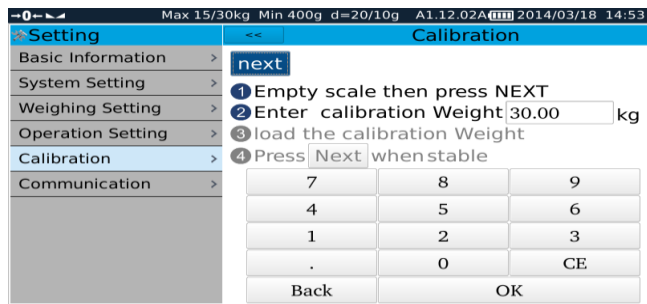

Press NEXT key,

Place the load on the platform as per entered the calibration weight value and

Press NEXT key,

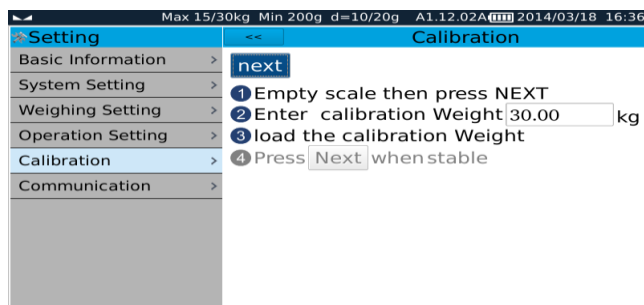

Wait for to display stable indication and

Press NEXT key,

Display will be show
PASS

Calibration has been finished.

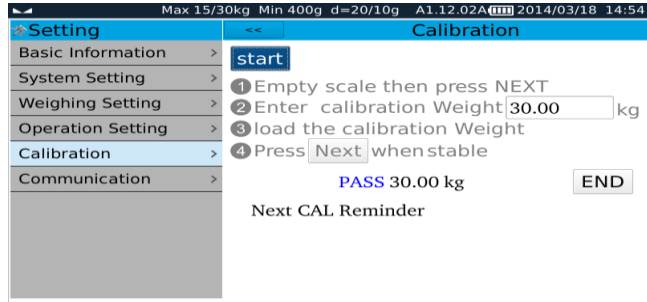

If its show, **FAIL**, Please Start again
Please do the calibration again.

Next Cal Reminder

If want to remind next calibration date, click the cal reminder box for to enable next cal date option. It will remind when its reach due date while initial start up.

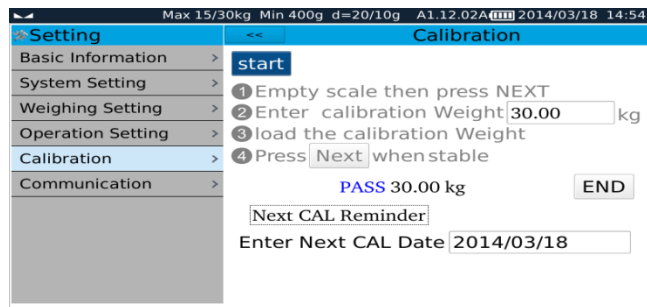

5.1.5.2. Linearity Calibration

If there is a linear difference, linear calibration option can use for to calibrate for to correct linear difference. For linear calibration can select calibration points 3 or 4 .

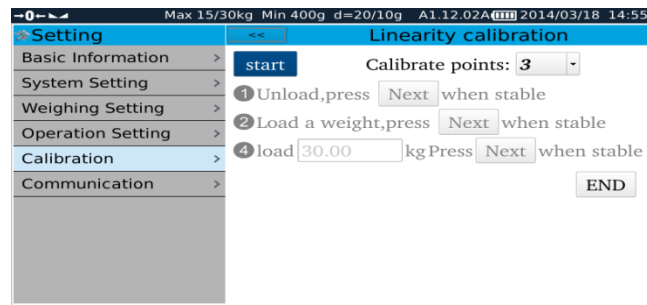

5.1.5.3. Internal Counts

The AD internal counts will be displayed. If load cell is connected and working correctly,

When you place goods on the pan, counts will be increase accordingly.

Press << key at the top of the left corner for to go back to last step , or press other options to go to next step.

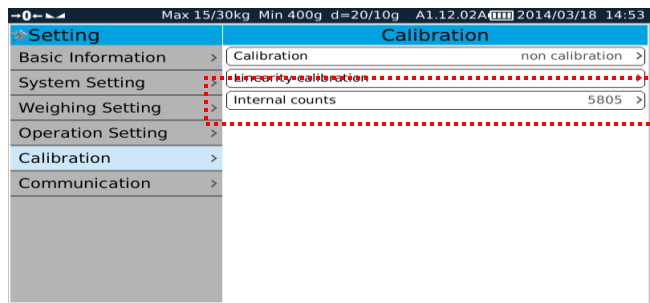

5.1.6. Communication

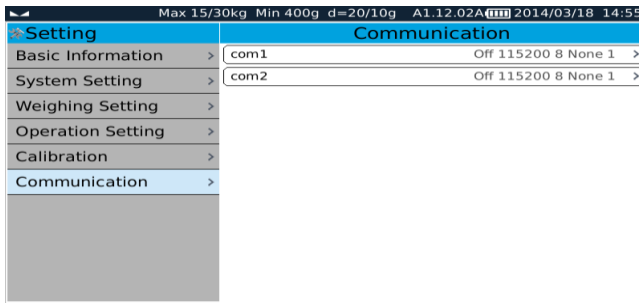

Com 1 or Com2 operations

Select the serial port options, including transmit mode, baud rate, data bits, and stop bits.

Mode: Selectable
 Off ; (Comport Off). / Continue;
 (Continues data send to PC) / ASK: (control by PC key board)
 EPM205, OS2130..etc.; (Printers)

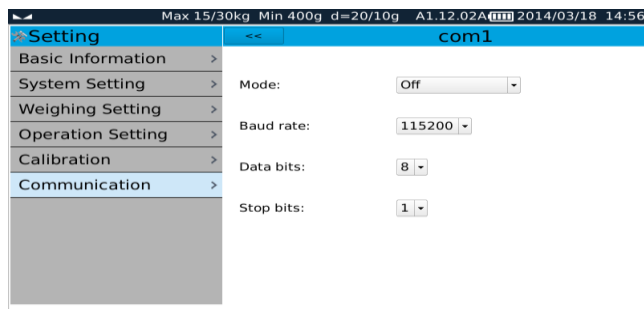

Baud Rate: Selectable; 600 to 115200

Data Bits : Selectable; 6 / 7 / 8

Stop Bits: Selectable; 1 / 2

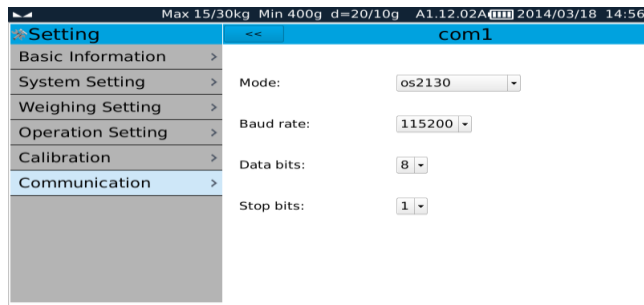

Press << key at the top of the left corner for to go back to last step, or press other options to go to next step.

5.2. Accumulation Operation Settings

Press  key to select accumulation operation mode

Manual: By pressing  key can do the accumulation operation.

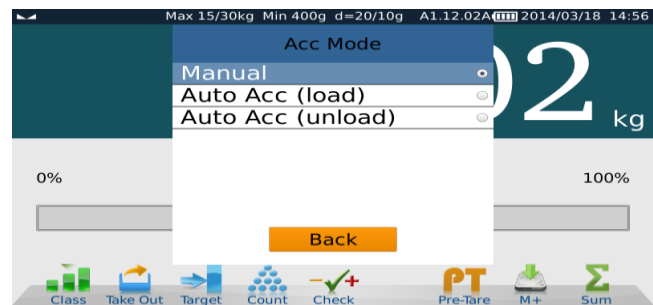

Auto ACC (load): When place the goods on the pan, it will accumulate and print automatically once get stable.

Auto Acc (Unload): When unload goods from the pan, it will accumulate and print automatically.

5.3.  Total Operation Settings

Total Operation will be define for Single Product or All product

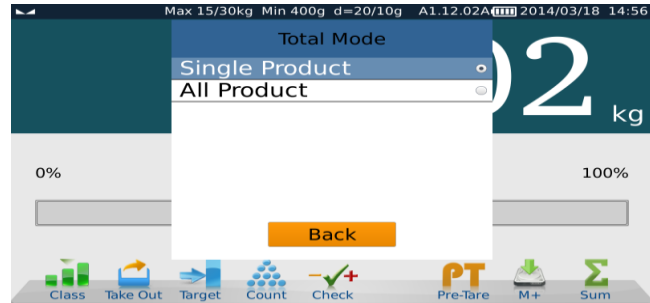

5.4.  Take Out Operation Settings

Take out Operation will be define for Manual or auto

Manual: By pressing  key can do the accumulation operation

Auto : Accumulation will be disable in auto function.

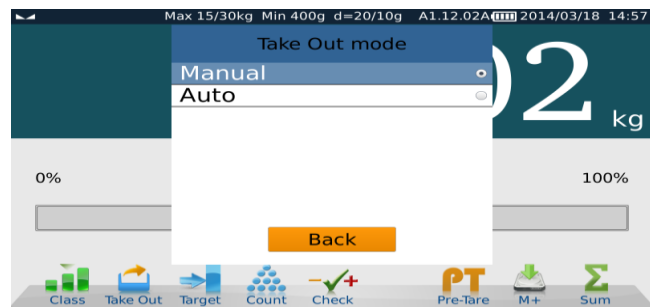

5.5.  Format Operation Settings

Print formats for different operation. It can be customized by using Tscale's TTC software.

Select print format and press Default key to confirm for print. Confirmation window will be show for to select comport and printer, select according to box and press OK to confirm.

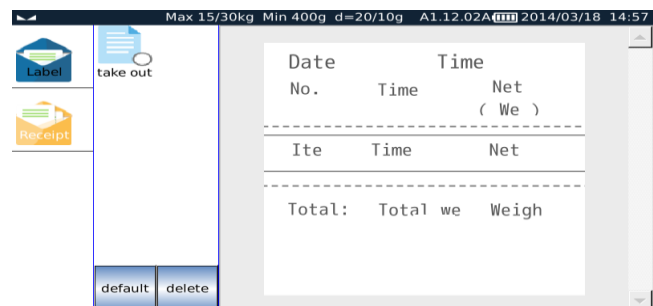
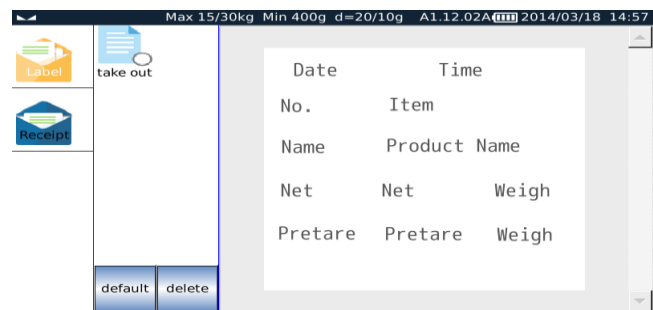

5.6. Data Export Settings

Press  key for to export data to USB disk. Before select this option, should be want to connect USB disk.

5.7. Help Settings

Press  key to read basic operation tutorial.



Tutorial display page can be change by pressing  key for next page and  key for previous page.

6. ERROR MESSAGE

Problem	Possible cause	Common solutions
Can't turn on power	Mains power is turned off Power supply not plugged in Power supply faulty Internal battery not charged Display turned off	Check power switch is turned on, and power LED is working. Verify the voltage going to the scale matches the power supply labels on the power module or scale.
Display is unstable	Air variation Pan touching somewhere Sample is moving (animal weighing) Vibrations through table Temperature changed dramatically Power supply / battery faulty	Verify the scale is in an acceptable location and on a good table / surface. Verify the power supply is correct for the scale.
Weight value incorrect	Calibration error, Recalibrate Linearity error, Linearity calibrated with inaccurate weight Balance not level some materials between the sample and cover, Wrong weighing unit displayed	Calibrate again, pay attention to the test weight used, the stability of the scale, and the required weighing unit. If it's required do the linear calibration. Check pan is installed correctly. Verify installed in an acceptable location.
Cannot use Full Capacity	Over load Stopper touching pan support or bottom of the load cell Transportation lock not removed, A/D circuit problem, Parameters set incorrectly, Load Cell or mechanics Damaged	Verify any objects under the pan or load cell, transporting lock, and verify pan installation. Check the weighing units used.
Not Linear	Overload stopper touching, Load cell or mechanics damaged A/D damaged	Verify any objects under the pan or load cell, transporting lock, and verify pan installation. Re calibrate and linear calibrate with ideal standard weights
Off Center Loading error	Adjust mechanism. Overload Stops not correct. Load Cell damaged	Verify any objects under the pan or load cell, transporting lock, and verify pan installation. Ensure load cell fixed correctly.
Battery will not charge	Mains voltage not present or too low Charging circuit failure Battery Failure	Check power supply voltage is correct. Verify the batteries are rechargeable types and charging voltage getting proper..
Touch screen incorrect	Touch screen need do correction	Connect a mouse, use mouse to enter touch screen correction for to calibrate

	Housing assembled by over tighten.	touch screen. Loose housing screws, if overtighten.
System hang	Software error, need restart	Hold ON/OFF key for 6 seconds to restart the scale. Disconnect battery and charger, connect again and turn on the power
Disconnect AC adapter will turn off power	Battery low	Verify the batteries are rechargeable types and charging voltage getting proper. Plug AC adapter to charge battery. Replace battery
LCD off but power LED on	Scale in sleep mode System hang	Press ON/OFF key to back to working mode Hold ON/OFF key for 6 seconds to restart the scale. Disconnect battery and charger, connect again and turn on the power
Can't turn on power after update software by USB	System hang Update software incorrect, Used old core software.	Disconnect battery and charger, connect again and turn on the power. Use another USB flash driver to update software. Update core software.

The product range can be summarized as follows:

- Counting scales for general industrial and warehouse applications.
- Digital weighing/check-weighing scales.
- High performance platform scales with extensive software facilities including parts counting, percent weighing etc.
- Digital electronic scales for medical use.
- Retail price computing scales.
- Floor scales.
- Truck scale.
- Crane scales.
- Weighing indicator for platform scales, floor scales and truck scales.
- Hand push and pull gauge.
- Customize auto weighing systems.

<p>Totalcomp Inc. 99 Reagent Lane Fair Lawn, NJ 07410</p>	<p>Tel.: 800-631-0347 Fax: 888-797-2288</p>
---	---

All information contained within this publication was to the best of our knowledge timely, complete and accurate when issued. However, we are not responsible for misimpressions which may result form the reading of this material.

