

AD-1682

Rechargeable Battery

INSTRUCTION MANUAL



This is a hazard mark (caution mark).

© 2005 A&D Company, Limited

No part of this publication may be reproduced, transmitted, transcribed, or translated into any language in any form by any means without the written permission of A&D Company Ltd.

The contents of this manual and the specifications of the instrument covered by this manual are subject to change for improvement without notice.

Warning Definitions

The warnings described in this manual have the following meanings:

Caution

A potentially hazardous situation which, if not avoided, may result in minor or moderate injury. It may also be used to alert against unsafe practice.

Note

An important description for proper use of the instrument.

Precautions

Caution

- Do not heat the battery, disassemble or dispose of in fire. It may build up heat, explode, or leak and cause a fire. Follow the local regulations when disposing of a used battery.
- Do not allow the battery to become wet. It may build up heat or cause a fire.
- Recharge the battery only after the battery has been discharged completely. Charging the battery repeatedly, with incomplete discharging, may result in heat buildup, generating gases or leaking.
- When charging the battery, use the charger provided with the battery. Using a charger other than the one provided may cause heat buildup and could cause a fire.
- The AD-1682 is designed to be used with balances manufactured by A&D. Using the AD-1682 with products other than specified may cause heat buildup and could cause a fire. Before use, see “1-4 List of Applicable Balances” to check which balances can be powered by the AD-1682.
- Keep the battery out of the reach of children.
- Do not drop or apply shock to the battery.

Compliance

Compliance with FCC Rules

Please note that this equipment generates, uses and can radiate radio frequency energy. This equipment has been tested and has been found to comply with the limits of Class A computing device pursuant to Subpart J of Part 15 of FCC rules. These rules are designed to provide reasonable protection against interference when the equipment is operated in a commercial environment. If this unit is operated in a residential area it may cause some interference and under these circumstances the user would be required to take, at his own expense, whatever measures are necessary to eliminate the interference.

(FCC = Federal Communications Commission in the U.S.A.)

Compliance with EMC Directives



This device features radio interference suppression in compliance with valid EC Regulation 89/336/EEC.

1. Introduction

1-1 About the AD-1682

The AD-1682 is a rechargeable battery exclusively designed for A&D-manufactured balances. Using the AD-1682, a balance can be operated in a location where an AC power source is not available.

Before use, see "1-4 List of Applicable Balances" to check which balances can be powered by the AD-1682.

1-2 Unpacking the AD-1682

In the carton you should find this manual and the following:

- Battery unit 1 pc
- 800 mA time delay fuse 1 pc
- Battery charger 1 pc
- Identification label 1 pc
- Instruction manual 1 pc

Please confirm that this charger type is correct for your local voltage and receptacle type.

Paste this label onto the battery charger.

This manual

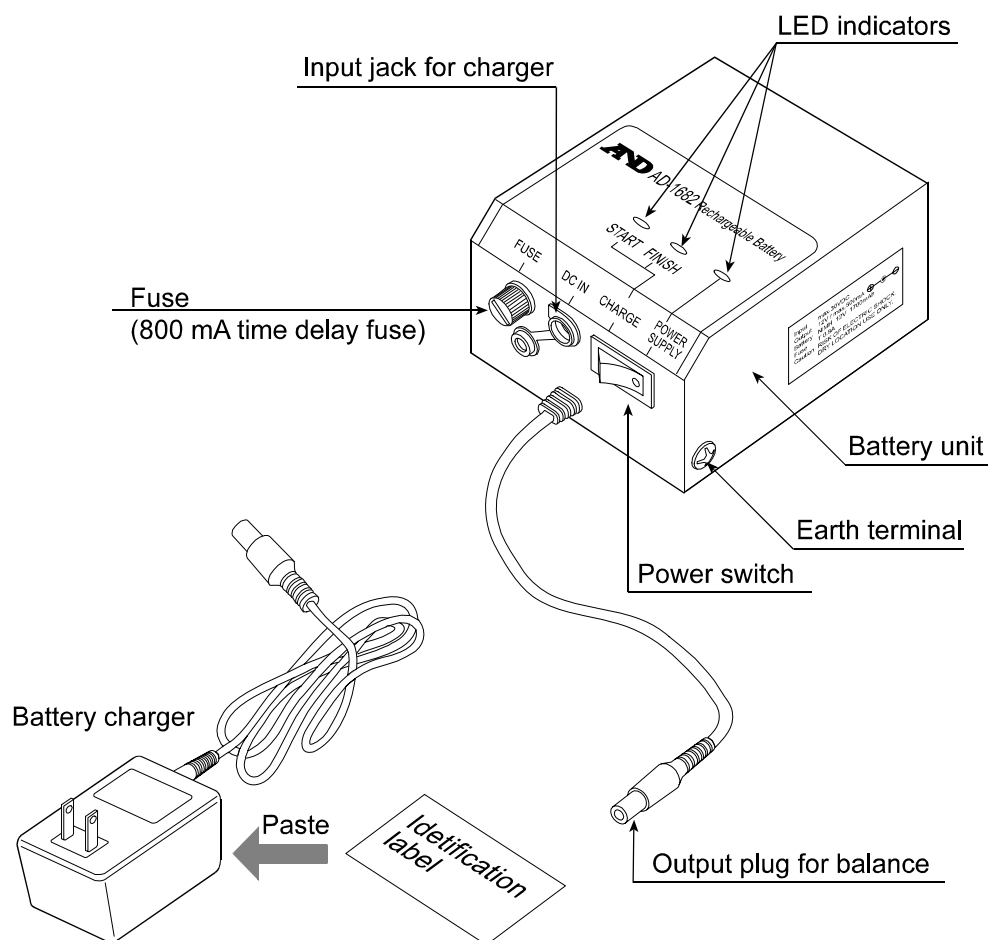

1-3 Specifications

Battery mass	Approximately 1.3 kg
Operating temperature range	+5°C to +40°C (+41°F to +104°F)
Storage temperature range	-20°C to +40°C (-4°F to +104°F)
Operation hours	Approximately 8 hours (when operated continuously using a GX series balance. Operation hours depend on operating conditions.)
Charging time	Approximately 15 hours
Charging method	Charge with timer function for an automatic stop
External dimensions	58 (H) x 96 (W) x 140 (D) mm
Output voltage	12 V (500 mA max.)
Battery type	Nickel-metal-hydride (Ni-MH) battery
Output cable length	Approximately 1 m

1-4 List of Applicable Balances

Use the AD-1682 only with balances listed below.

Balances	Continuous operation hours (Depends on operating conditions)
HX series	5 hours
GP series, GX-K/GF-K series	6 hours
FC series, FP series, GH series, GR series, GX/GF series, HM series, HP series, HR-202, HR-300, HR- <i>i</i> series	8 hours
ET-W series, HF series, HR-60, HR-120, HR-200	16 hours
EK-G series, EK-H series, EW-G series	28 hours
HC series, HD series	66 hours

The AD-1682 can be used for other instruments than balances as shown below.

Instruments	Continuous operation hours (Depends on operating conditions)
SV series (Viscometer)	5 hours
AD-8922 (Remote controller)	12 hours

Note

In this manual, "balance(s)" refers to the A&D-manufactured products listed in the tables above.

1-5 Notes on Using the AD-1682

- The continuous operation hours depend on the operating conditions.
- The battery, while it is being charged, will not supply power to the balance.
- Do not short-circuit the output plug.
- The battery may self-discharge while it is left unused for a long period of time. Charge the battery after a long period of non-use.
- The balance, after the display is turned off using the ON/OFF key, is still consuming power. To turn the power off completely, disconnect the charger from the battery and turn the power switch to the "CHARGE" position. (If the charger is connected to the battery under this condition, the battery will start charging.)
- Every time the power switch is turned to the "CHARGE" position with the charger connected to the battery, the battery will start charging. Charging the battery before it is completely discharged will shorten the battery life.

2. Charging the Battery

Notes

- Charging the battery before it is completely discharged will shorten the battery life. Whether the battery is completely discharged or not can be determined by the POWER SUPPLY LED indicator when the charger and the battery are disconnected:

Indicator "ON"= The battery has some charge remaining.

Indicator "OFF" =The battery is completely discharged.

- Charge the battery fully, until the START LED indicator turns off and the FINISH LED indicator turns on. This procedure will take about 15 hours.
- During the charging operation, the battery will not supply power to the balance.
- In case that both indicators of the START LED and FINISH LED blink, the output voltage of the battery charger is not enough. Use the specified charger and confirm the voltage of the power source.

Charge the battery as follows:

1. Make sure that the battery is completely discharged.

When the battery is completely discharged:

- With the charger disconnected, when the power switch is turned to the "POWER SUPPLY" position, the POWER SUPPLY LED indicator will be off.
- If the balance can detect the low battery, "L b" is displayed.

Note

The battery can start charging even when the POWER SUPPLY LED indicator is on.

2. Turn the power switch to the "CHARGE" position.
3. Connect the charger to the battery. The battery will start charging. The START LED indicator will blink during the charging operation.
4. Charging will complete automatically after about 15 hours, when the START LED indicator turns off and the FINISH LED indicator turns on.

5. After charging is complete, disconnect the charger from the battery to avoid recharging.

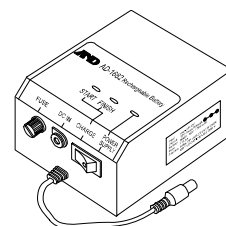
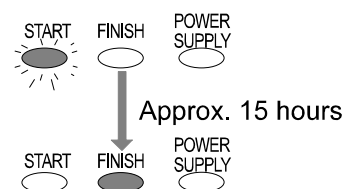
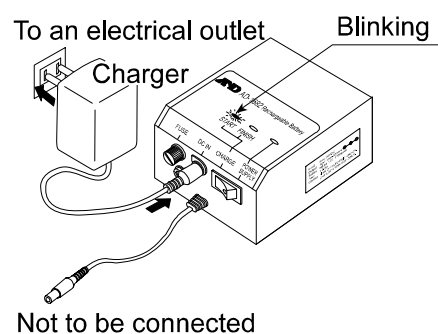
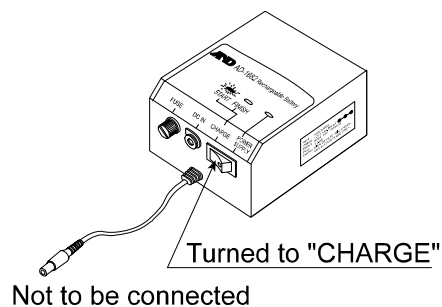
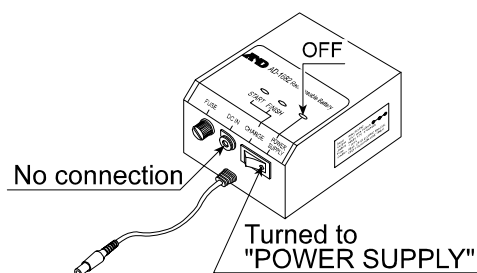

3. Using the Battery

Use the battery to supply power to the balance as follows:

1. After charging is complete, disconnect the charger from the battery.
2. Insert the output plug into the balance.
3. Turn the power switch to the "POWER SUPPLY" position. The POWER SUPPLY LED indicator will be turned on and the battery will start supplying power to the balance. The POWER SUPPLY LED indicator will be on during the power supplying operation.
4. When the balance is not to be used, turn the power switch to the "CHARGE" position. The POWER SUPPLY LED indicator will be turned off to indicate that the battery is not supplying power to the balance.
5. While the balance is in use, if the remaining charge decreases and the voltage drops, the POWER SUPPLY LED indicator will be turned off automatically to shut off the battery. Under this condition, turn the power switch to the "CHARGE" position to protect the battery.

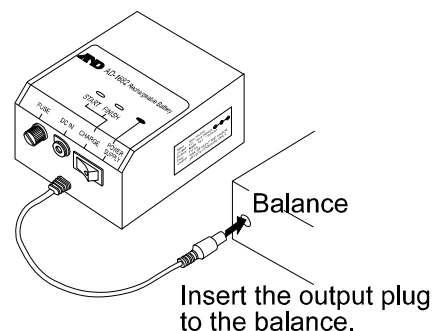

While in use

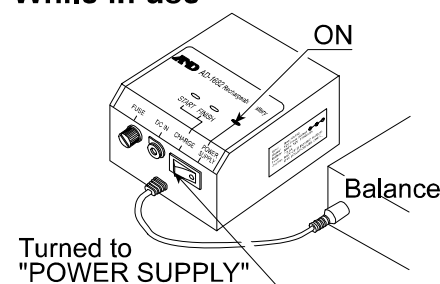

While not in use

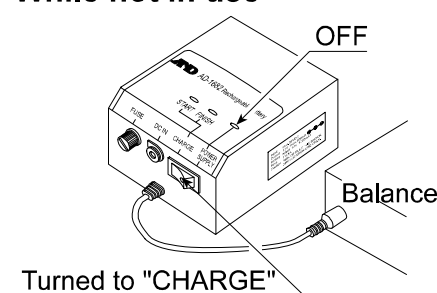

Note

Much care is required with the connection as illustrated at the right. (The charger and the battery are connected simultaneously.) Charging may start inadvertently.



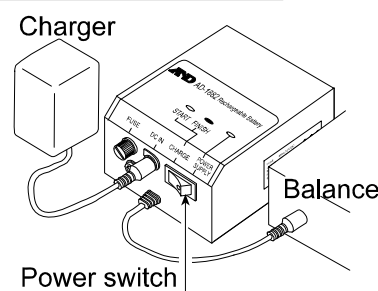

The charger operates as listed below, depending on the power switch condition.

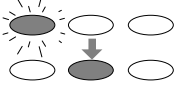
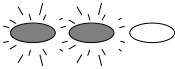

Power switch condition	What happens
Turned to "POWER SUPPLY"	The charger supplies power to the balance. And the charger does not charge the battery.
Turned to "CHARGE"	The charger charges the battery (recharging). And the charger does not supply power to the balance. The balance will not operate.

4. Battery Condition and Operation

The combination of the power switch, charger, and LED indicator conditions, leads to as shown below:

Power switch	Charger	LED indicators START FINISH POWER SUPPLY	Operation
"CHARGE"	Connected		Being charged. Approximately 15 hours to full charge. (See note 1). Power will not be supplied to the balance.
"CHARGE"	Connected		The output voltage of the battery charger is not enough. Use the specified charger and confirm the voltage of the power source.
"CHARGE"	Not connected		None
"POWER SUPPLY"	Not connected		The battery is supplying power to the balance. (See note 2).
"POWER SUPPLY"	Connected		The charger is supplying power to the balance.

Note 1: Charge the battery after it is completely discharged.

Note 2: About the continuous operation hours using the battery, see "1-4 List of Applicable Balances".

