

Totalcomp

Technical Manual

M701



Handrail scales

REV: M1, April,05, 2014
(v3.09-3.014)

CONTENTS

1. PRECAUTIONS.....	2
2. INTRODUCTION.....	3
3. SPECIFICATIONS.....	4
3.1 Specifications.....	4
3.2 Load Cell Specification.....	5
4. INSTALLATION.....	6
5. DESCRIPTION.....	8
6. OPERATION.....	10
1. Power ON/OFF.....	10
2. Zero.....	10
3. Tare.....	10
4. Hold function.....	11
5. Precision*10.....	11
6. BMI function.....	11
7. Print function.....	11
7. PARAMETER.....	12
8. CALIBRATION.....	14
9. BATTERY OPERATION.....	15
10. MAINTENANCE.....	16
10.1 General.....	16
10.2 Error codes.....	17
10.3 Determine the Problem.....	17
10.4 Check the Load Cell.....	17
10.5 Check PCB Voltages.....	18
10.6 Trouble Shooting.....	19
11. DISPOSAL.....	21

1. PRECAUTIONS

	 WARNING
	DISCONNECT ALL POWER TO THIS UNIT BEFORE INSTALLING, CLEANING, OR SERVICING. FAILURE TO DO SO COULD RESULT IN BODILY HARM OR DAMAGE THE UNIT.

 CAUTION
<ul style="list-style-type: none">• Permit only qualified persons to service the instrument• Before connecting or disconnecting any components, remove the power.• Failure to observe these precautions bodily harm or damage to or destruction of the equipment.

- Follow the instructions in the instructions for use.
- Keep the operating instructions and the declaration of conformity in a safe place.
- Ensure that the scale is standing firmly on a smooth, level surface.
- Do not drop the scale or subject it to violent shocks.
- When using the scale with a mains unit, ensure that the supply cable is routed in such a way as to exclude any type of tripping hazard.
- Use only the type of battery stated.
- Have scale serviced and re-calibrated on a regular basis.
- Have repairs carried out only by authorized persons.

2. INTRODUCTION

- The M701 series handrail scales, that amplifies signals from a load cell, converts it to digital data and displays it as a mass value.
- BMI with bar graph.
- Wheels at bottom, easy to move.
- Rubber mat on the surface of the platform.
- 25 mm LCD with white LED back light display
- 7 keypads are light touch switches
- Battery provide up to 20 hours of continues use (without backlight)
- Capacity is up to 550lb.

3. SPECIFICATION

3.1 Specifications

Model	M701
Maximum Capacity	550lb
Readability	0.1lb
Resolution	1/5000
Tare range	-549.9lb
Minimum Capacity	2lb
Linearity \pm	0.02lb

Common Specifications	
Interface	RS-232 Output Optional
Stabilisation Time	2 Seconds typical
Operating Temperature	0°C - 40°C / 32°F - 104°F
Power supply (external)	12V/500mA AC power adapter or 2000mAh Ni-MH batteries (optional, size AA)
Calibration	Automatic External
Calibration as per Directive 90/384/EEC	Class III medical approval
Medical product as per Directive 93/42/EEC	Class I
ADC	Σ - Δ
Display	25 mm high 6 digits LCD with auto backlight and loading bar graph
Housing	Aluminium pan and pole, ABS plastic indicator
Pan Size	600x600mm

3.2 Load Cell Specifications

Model No	H8C
Rated Capacity (klb)	1/1.5/2/2.5/3/4/5/7.5/10/20
Sensitivity	3.0 ± 0.003 (mv/v) 2.0 ± 0.002 (mv/v)
Excitation Voltage	5~12V
Material	Alloy steel
Cable	0.3~4m Φ 5mm
Input Resistance	350Ω ± 3.5Ω
Out put Resistance	350Ω ± 3.5Ω
Temperature Range	-35~+70° C
Safe overload	150%F.S
Ultimate overload	300%F.S
Error	±0.020%F.S
Creep (30min)	≤ ±0.016%F.S

4. INSTALLATION

Unpacking

Carefully take the balance out of its package, make it sure its not damaged and all accessories are included.

- Remove the weighing scale from the carton.
- Remove the protective covering. Store the packaging and to use if you need to transport the scale later.
- Inspect the scale and terminal for damage.
- Make sure all components are included

Accessories,

1. Balance
2. Adaptor
3. Product manual

Level Adjusting

Place the scale on a table.

Check the water mark. If, bubble is not centre adjust the leveling feet until reach centre. Check the level when you change the location.

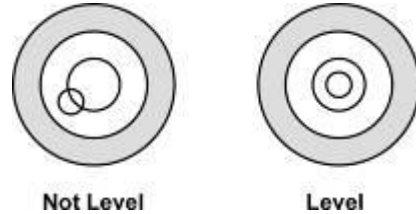

Charging Battery

- To charge the battery insert the adaptor pin to jack, jack is locating rear side of the scale. Adaptor simply plug into the mains power. The scale no needs to be turned on.
- The battery should be charged for 12 hours for full capacity.
- In the display there is an indicator show the status of battery charging. When the scale is plugged into the mains power the internal battery will be recharged. If the indicator off, the battery has a full charge. If it is on, the battery is nearly discharged and if yellow, the battery is being charged.
- Do not use any other type of power adaptor than the one supplied with the scale.
- Verify that the AC power socket outlet is properly protected.

Note: Please charge the battery before using the scale for the first time

Installation

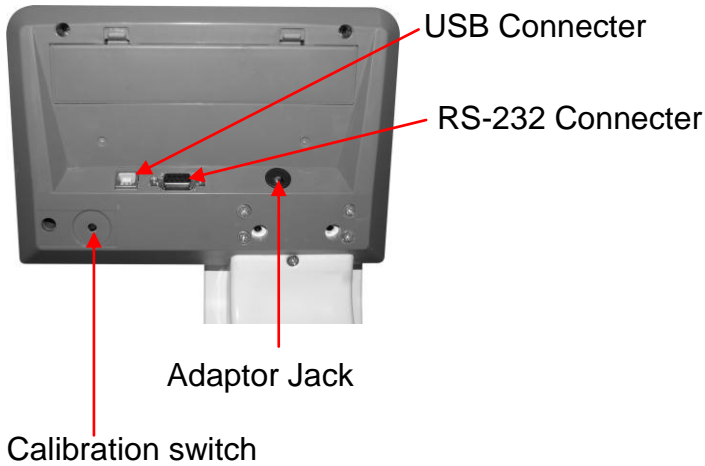

- Place the scale on a table.
- Connect the adaptor pin in to the scale adaptor jack. Adaptor jack is locating, rear side of the scale.
- Adaptor connects into your AC power socket. Pluggable equipment must be installed near an easily accessible socket outlet with a protective ground/ earth contact.
- Turn on the On/Off key. If you want to turn off, press the key again.
- Display will be show the version number and will be starting self checking.
- After self checking, display will be come to normal weighing mode.
- **Warm-up time of 15 minutes stabilizes the measured values after switching on.**
- Calibrate with exact calibration weights, minimum 1/3 of the scale capacity want to use for calibration. For calibration see details in parameter.









Then you can start your operation

5. DESCRIPTION





Key Board

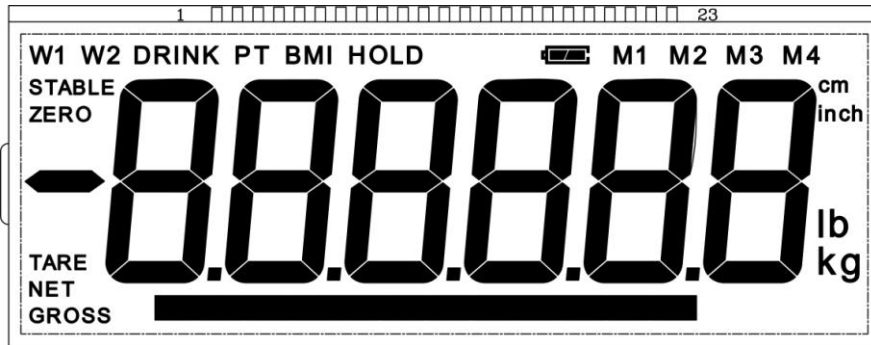

	Turns the scale power On / Off
	Set to hold mode
	Set to BMI mode
	Print the weight value / Enter into the menu
	1. Enter parameter settings 2. Choose menu block or options one by one 3. Increase the digital number
	Sets display to Zero
	Subtracts weight of container

Display



DISPLAY	FUNCTION
STABLE	Indicator for Display stability
ZERO	Indicator for Zero display
TARE	Indicator for Tare display
	Indicator for weighing capacity graph
NET	Indicator for Net weight
GROSS	Indicator for Gross weight
Cm/inch	Indicator for measuring units
Lb/kg	Indicator for weight units
	Indicator for Charging status of battery Voltage has dropped
	
	
	Low Voltage
	Fully Charged

6. OPERATION

Initial Start-up

Warm-up time of 15 minutes stabilizes the measured values after switching on.

6.1 Power ON/OFF

Press  to switch on the scale, display will start self test. If you want to switch off, press this key again.

6.2 Zero

You can press  at any time when the value is stable to zero the display .

6.3 Hold function

Press  before load at the pan, so HOLD is active now. "Hold " and "--" appeared at the display.

After put load at the pan, no indication until a stable non-zero weights is detected. During this period "----" is indicated. (no indication of unstable value). You will hear a beep, when stable weight is detected.





Then it will show calculated HOLD-value with small "HOLD". After unloading the pan, the value will last for 10 Seconds, then it will come back to normal weighing model.

Pressing , while the HOLD-function is active, will cancel the HOLD-function.

6.5 Precision*10

If you want to see more accurate weight value, press and hold  for 2 seconds, display will show one more decimal place, the last digit will twink for 5 seconds, then it will go back to normal weighing value automatically.

6.6 BMI function

Press  key in normal weighing mode, display will show the last height “xxxxx”, use  key to shift twinkling digit, and press  key to set the value, press  key to confirm it, display will enter into the BMI mode, “BMI” indicator will be shown, people stand on the platform, display will show BMI value and the BMI bar graph.

Press  key to turn back to normal weighing mode.

6.7 Print function

You can connect an external printer OS-2130D or Tp-up to printer out the result, the print key is .

Print format:

PRT	Print format
0	2014/04/05 11: 00 120.0 lb
1	2014/04/05 11: 00 120.0 lb 170.0cm 20.7BMI
2	120.0 lb
3	12.0 lb 170.0cm 20.7BMI

Note: TPUP can't print out the date and time.

7. PARAMETERS

Enter the Menu

- In normal weighing model, press and hold  key, display will show

F 1 OFF

Choose the Menu

- Press , you can choose menu block or options one by one.

Enter the Selected Menu

- Press , it can confirm which is displayed.

Enter in to TECH

Note: Before enter the tech menu, press calibration switch, which is locating below the scale

- When display showed *P 1 n*, press   and  keys to enter the function



Escape from the Menu

- Press  key, it can escape from the menu to weighing mode.

Parameter Block













Menu	Sub Menu	Description
<i>F 1 OFF</i>	<i>OFF 0/ 3/ 5/ 15/ 30</i>	To set the auto close the scale time (mins). 0 means auto off function is disabled
<i>F 2 SUT</i>	<i>OFF</i>	Disable print function.
	<i>Prt</i>	Enable print function
	Select first RS 232 or USB	
	<i>P Prt</i>	<i>b ****</i> Set baud rate

M701 Series Handrail Scales technical Manual

F3 Prt	Manually print	Prt*	Set print format 0-3
		LPUP LP-50	Select Tp-up or Lp-50 printer
	P Cont	b ****	Set baud rate
		Cont *	3 different protocol, default setting is 1
		SdO on SdO of	It will send data when display is 0 It won't send data when display is 0
	P AUto Automatically print	b ****	Set baud rate
		Prt*	Set print format 0-3
		LPUP LP-50	Select Tp-up or Lp-50(OS-2130D) printer
	AST	ASK mode Command W: read data at anytime Command S: read stable data Command T: Tare Command Z: Zero	
	P StAb	Send data when weighing value is stable	
SE irE	Also send data continuous		
P Cnt2	Send data another continuous mode.		
F4 bt	bL on	enable backlight	
	bL ofF	disable backlight	
	bL AU	Set the backlight automatically on.	
F6 tCH	P in	Enter the password   and 	
P 1 SPd	Set the A/D convert speed(7.5/15/30/60)		
P 2 CAL	dESC	Set decimal points	
	inC	Set increment	
	CAP	Set capacity	
	CAL	Enter into calibration	
P 3 Pro	tr i	Factory function	
	CoUnt	To show the scale internal count	
	rESEt	Reset the scale	
	SEtGrA	Set the gravity value	

8. CALIBRATION

Calibration Settings in the Parameter;

- Turn on the scale, when in the normal display
- Press and hold  key, display will show F1 OFF
- Press  key, display will show tCH
- Press  key to confirm display will show P in
- Press   and  keys, display will show P1 SPd
- Press  key, display will show P2 CAL
- Press  key to confirm, display will show UnLoAd
- clear platform, When scale get stable, Press  key, display will show
the calibration value,(You can press  and  to change the value)
then press  to confirm, display will show LoAd
- Place the test weight on the platform, after stable, press  key to confirm
Display will show PASS
- Then will start self-test and will come to normal display.

9. BATTERY OPERATION

The Medical Scales can be operated from the battery if desired. The battery life is about 20 hours.

When the battery needs charging a symbol on the weight display will turn on. The battery should be charged when the symbol is on. The scale will still operate for about several minutes after which it will automatically switch off to protect the battery.

To charge the battery simply plug into the mains power. The scale does not need to be turned on.



The battery should be charged for 12 hours for full capacity.

Just under the quantity display is an LED to indicate the status of battery charging. When the scale is plugged into the mains power the internal battery will be charged. If the LED is green the battery has a full charge. If it is blue, It indicates the battery is being charged.

As the battery is used it may fail to hold a full charge. If the battery life becomes unacceptable then contact your distributor.

Note: useless battery should be recycled, not throw away as normal life refuse.

10. MAINTENANCE

	 WARNING
	DISCONNECT ALL POWER TO THIS UNIT BEFORE INSTALLING, CLEANING, OR SERVICING. FAILURE TO DO SO COULD RESULT IN BODILY HARM OR DAMAGE THE UNIT.

 CAUTION
<ul style="list-style-type: none">• Permit only qualified persons to service the instrument• Before connecting or disconnecting any components, remove the power.• Failure to observe these precautions bodily harm or damage to or destruction of the equipment.

10.1. General

If the scale does not operate properly, find out the problem as possible. Determine whether the problem is constant or alternate. Be aware that problems can be caused by mechanical or electrical influences.

Check the following.



- Water
- Corrosive materials
- Vibrations or temperature or wind
- Physical damage

Check the scale cables for damage, and check all connections and connectors for any loose contact or incorrect connection

Cleaning

- Disconnect the power before cleaning.
- Use a cloth with mild suds and light cleaning agents.
- Make sure that fluid not able to get into the device.
- Use a clean and soft cloth for rub off.

10.2. Error Codes

Error Code	Description	POSSIBLE CAUSES
<i>Err 4</i>	Exceed manual zero range  (press )	<ul style="list-style-type: none"> • Goods on the platform • Overload, when zeroing the scale. • Improper calibration • Load cell problem • PCB problem
<i>Err 5</i>	A/D Count out of the range	<ul style="list-style-type: none"> • Platform not installed • Load cell problem • PCB problem
<i>Err 19</i>	Exceed Auto Zero range When switch on the scale	<ul style="list-style-type: none"> • Goods on the platform • Improper calibration • Load cell problem • PCB problem

10.3. Determine the Problem

Determine whether the problem is in the PCB or the Load Cell

- Remove power from the system, and disconnect the load cell connection from the PCB
- Connect the PCB to a load cell simulator
- Reapply power and test the PCB
- If problem goes away, its source is probably in the Load cell. Check the wiring, connector, load cell and mechanical components of the load cell.

If problem persists, its source is probably in the PCB. Check the PCB voltages, connectors, cables and function programs

10.4. Check the Load cell

- Remove power from the system, and disconnect the PCB from the Load cell
- Check the moisture, or foreign material inside.
- Make sure all leads are connected and correctly.
- Check load cell for proper input and output resistances

Load Cell Connections

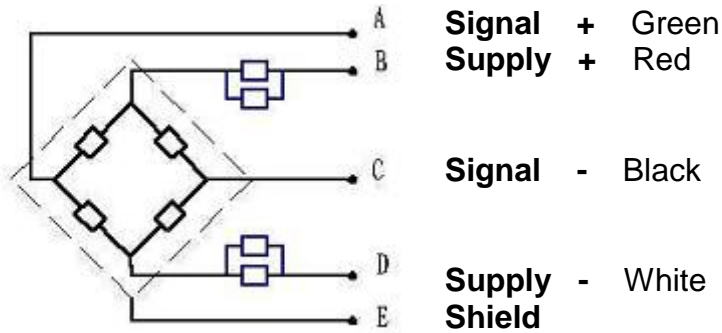

Measuring Points	Resistance
Red (+ Exc) to White (-Exc)	420 \pm 20 Ω
Green (+Sig) to Black (-Sig)	350 Ω \pm 5 Ω

10.5. Check PCB Voltages

If the problem is in the PCB, use a multi meter to check the following voltages

10.5.1 AC Power

Check the AC power socket out put voltage.

- Voltage must be a -20% and +10% of the normal AC voltage.

10.5.2 Adaptor Voltage

Check the adaptor output cable connector voltage

- Voltage must be minimum 9VDC and maximum 15VDC

10.5.3 PCB Input Voltage

Check the PCB input power connector voltage

- Voltage must be minimum 9VDC in to the pin AD+

10.5.4 Check Battery Voltage and Charging Voltage

1. Check the Battery Voltage,
 - Voltage must be minimum 6VDC. If below the 6VDC connect the adaptor for charging
 - The battery voltage below the 5.5VDC, replace the battery and install new 6V/3.4Ah battery.

2. Check the Battery Charging Voltage;
 - Remove the battery connection terminals (Red and Black) from the battery.
 - Connect the power and turn on the scale
 - Voltage into the terminal minimum 6.5VDC

10.6 Trouble Shooting

Problems	Possible cause	Common Solutions
Display is blank. No self test	Mains power is turned off. Power supply faulty or not plugged. Internal battery is not charged. On/Off switch problem	Check power is getting inside the scale and on/off switch is working. Verify the voltages, which is on the power labels.
Blank display after self test	Pan not installed. Unstable weight, load cell damaged	Check the pans are installed correctly. Try to turning on again.
OL or -----	Maximum capacity exceeded. Load cell or mechanics damaged. Power supply faulty	Check the platform is installed correctly. Try to turn on the scale again. Do the calibration again
----- or NULL displayed	Weight is on the platform is below permissible limit. Pan not installed correctly. Power supply faulty. Load cell or mechanism faulty	Check the platform is installed correctly. Try to turn on the scale again. Do the calibration again
Display is unstable	Goods touching somewhere. Air variation or any vibrations. Temperature changed . Load cell or connections faulty. Power supply faulty	Check the scale is in acceptable location. Check the connectors and load cell. Check the power supply and battery

M701 Series Handrail Scales technical Manual

Weight value incorrect	Calibration error. Platform of load cell touching somewhere. Wrong weighing unit	Use accurate weight for to do the calibration Check the pan and load cell is installed proper and touching. Check the parameter settings. Check the load cell and connectors
Can not use full capacity	Over load protection stoppers or transport locks are not removed. Parameters are set incorrectly. AD problem. Load cell or mechanism damaged	Check the stoppers and locks under the platform. Check the weighing unit and parameter settings. Check the load cell.
Platform Corner Weight different	Over load protection stoppers or transport locks are not removed. Load cell or mechanism damaged	Check the stoppers and locks under the platform. Use accurate weight for to do the calibration Check the load cell.
Battery not charging	Mains voltage problem Charging circuit problem Battery Problem	Check the mains and adaptor. Check the battery. Check the charging circuit

11. DISPOSAL

Disposing of the device



Do not dispose of the device in domestic waste. The device must be disposed of properly as electronic waste. Follow the national regulations which apply in your case. For further information, contact our service department at: service@taiwanscale.com

Batteries

Do not throw used batteries away in domestic waste. Dispose of batteries at collection points in the vicinity. When buying new batteries, select those low in harmful substances and containing no mercury (Hg), cadmium (Cd) or lead (Pb).