

Operating Instructions**Sartorius Moisture Analyzer**

Model MA35

Electronic Moisture Analyzer

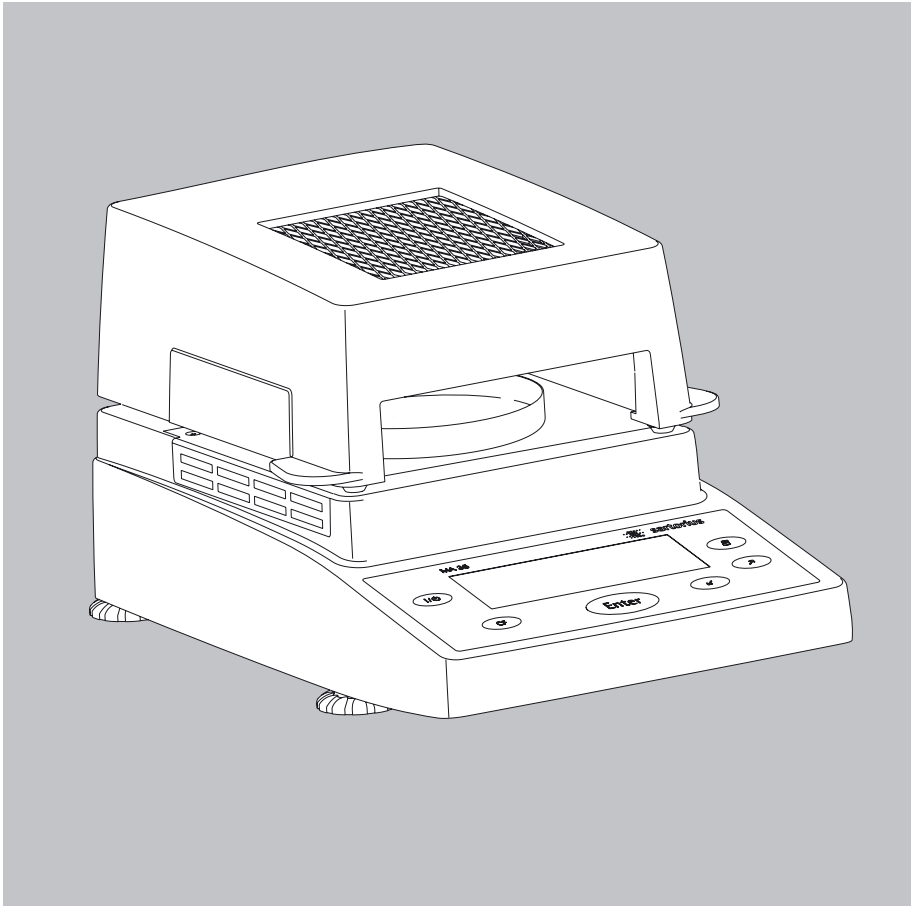

Intended Use

The MA35 moisture analyzer is intended for fast and reliable determination of the moisture content of materials of liquid, pasty and solid substances using the thermogravimetric method.

Symbols

The following symbols are used in these instructions:

- indicates steps you must perform
- indicates steps required only under certain conditions
- > describes what happens after you have performed a particular step
- indicates an item in a list
-  indicates a hazard

Contents



Intended Use	2
Warnings and Safety Information ..	3
Getting Started	6
General View of the Equipment.	6
Equipment Supplied	7
Connecting the Moisture Analyzer to AC Power	9
Leveling the Moisture Analyzer	11
Turning On the Analyzer; Opening and Closing the Sample Chamber ...	12
Operating Design	13
Keys	13
Display	14
Configuration	15
Setting the Device Parameters.	15
Setting the Drying Parameters.	17
Operation	21
Example: Analysis with Specified Drying Time	21
Adjusting the Analyzer	23
Heating Element Adjustment	23
Weighing System Adjustment	23
External Calibration and Adjustment with a Factory-Defined Weight	24
Interface Port	26
Pin Assignments	27
Error Codes	28
Care and Maintenance	29
Safety Inspection	31
Overview	32
Specifications	32
Accessories (Options)	33
Declaration of Conformity	34

Warnings and Safety Information

This moisture analyzer complies with the European Council Directives as well as international regulations and standards for electrical equipment, electromagnetic compatibility, and the stipulated safety requirements. Improper use or handling, however, can result in damage and/or injury.

To prevent damage to the equipment, read these operating instructions thoroughly before using your MA35 moisture analyzer. Keep these instructions in a safe place.

Follow the instructions below to ensure safe and trouble-free operation of your moisture analyzer:

-  Use the moisture analyzer only for performing moisture analysis on samples. Any improper use of the analyzer can endanger persons and may result in damage to the analyzer or other material assets.
-  Do not use this moisture analyzer in a hazardous area; operate it only under the ambient conditions specified in these instructions.
-  If you use electrical equipment in installations and under ambient conditions subject to stricter safety standards than those described in the manual, you must comply with the provisions as specified in the applicable regulations for installation in your country.
- The moisture analyzer may be operated only by qualified persons who are familiar with the properties of the sample to be analyzed.

 Make sure before getting started that the voltage rating printed on the manufacturer's label is identical to your local line voltage (see "Connecting the Moisture Analyzer to AC Power" in the chapter entitled "Getting Started").

- The analyzer comes with a power supply that has a grounding conductor.
 - The only way to switch the power off completely is to unplug the power cord.
 - Position the power cord so that it cannot touch any hot areas of the moisture analyzer.
 - Use only extension cords that meet the applicable standards and have a protective grounding conductor.
 - Disconnecting the ground conductor is prohibited.
 - Connect only Sartorius accessories and options, as these are optimally designed for use with your moisture analyzer.
- Note on installation:
The operator shall be responsible for any modifications to Sartorius equipment or connections of cables not supplied by Sartorius and must check and, if necessary, correct these modifications. On request, Sartorius will provide information on the minimum operating specifications (in accordance with the Standards listed on p. 33 for defined immunity to interference).
- Protect the analyzer from contact with liquid
 - If there is visible damage to the equipment or power cord, unplug the equipment and lock it in a secure place to ensure that it cannot be used for the time being.

 Clean your moisture analyzer only according to the cleaning instructions (see “Care and Maintenance”).

Do not open the analyzer housing. If the seal is broken, this will result in forfeiture of all claims under the manufacturer’s warranty.

If you have any problems with your moisture analyzer:

- contact your local Sartorius office, dealer or service center



Warning: Severe Burns!

- When setting up the moisture analyzer, leave enough space to prevent heat from building up and to keep your analyzer from overheating:
 - leave 20 cm (about 8 inches) around the moisture analyzer
 - leave 1 m (3 ft.) above the moisture analyzer
- Do not place any flammable substances on, under or near the moisture analyzer, because the area around the heating unit will heat up
- Be careful when removing a sample from the chamber: the sample, the heating unit and the sample pan may still be extremely hot
- Prevent excess heat build-up around the analyzer

Hazards for persons or equipment posed by certain sample materials:



Fire



Explosion

- Flammable or explosive substances
- Substances that contain solvents
- Substances that release flammable or explosive gases or vapors during the drying process

In some cases, it is possible to operate the moisture analyzer in an enclosed nitrogen atmosphere to prevent the vapor released during drying from coming into contact with oxygen in the surrounding atmosphere. Check on a case-to-case basis whether this method can be used, because installation of the analyzer in too small an enclosed space can affect its functioning (for instance, through excessive heat build-up within the analyzer). When in doubt, perform a risk analysis.

The user shall be liable and responsible for any damage that arises in connection with this moisture analyzer.



Poisoning



Caustic burns

- Substances containing toxic or caustic or corrosive components may only be dried under a fume hood. The value for the “lower toxic limit” in a work area must not be exceeded.

Corrosion:

- Corrosion may be caused by substances that release aggressive vapors during the heating process (such as acids).

We recommend working with only small quantities of such samples, to avoid build-up of vapors that can condense on cold housing parts and can cause corrosion.

The user shall be liable and responsible for any damage that arises in connection with this moisture analyzer.

Getting Started

General View of the Equipment

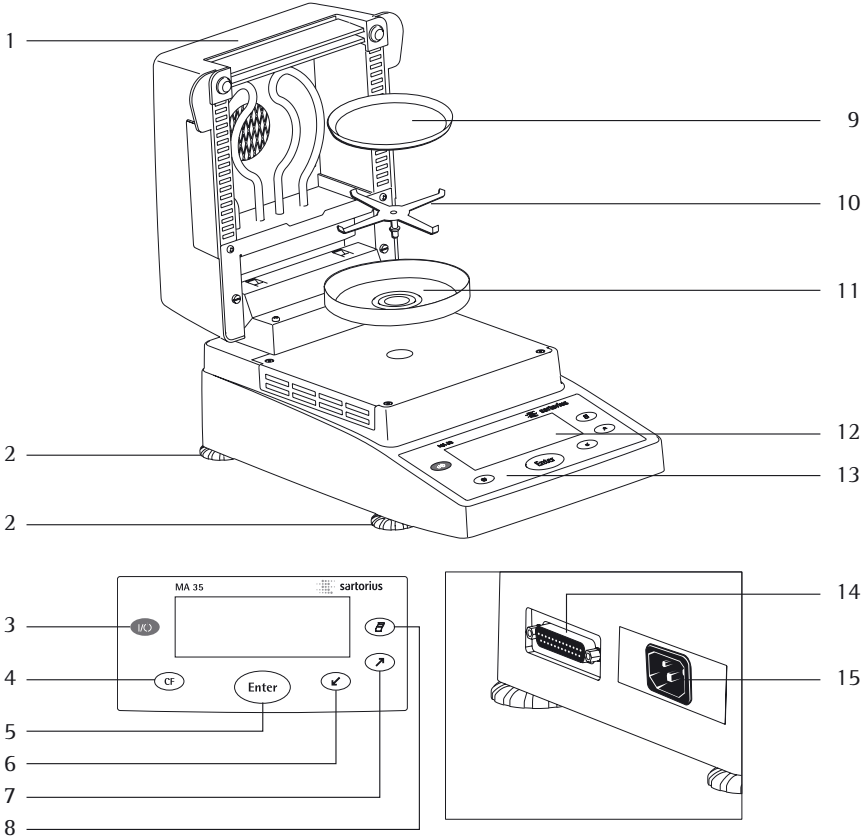

Pos.	Designation
1	Hinged cover with heating element
2	Leveling feet
3	On/off key
4	CF key (clear function; delete)
5	Enter key (confirm)
6	'Down/Back' key
7	'Up/Forward' key
8	Print key

Pos.	Designation
9	Disposable sample pan
10	Pan support
11	Pan draft shield
12	Display
13	Keypad
14	Interface port
15	Power jack

The moisture analyzer consists of a heating unit, a weighing system, and a display and control unit. In addition to the socket for AC power (mains supply), it also has an interface port for connecting peripheral devices, such as a computer, printer, etc.

Storage and Shipping Conditions

Allowable storage temperature:
0 to 40°C; 32 to 104°F

Do not expose the moisture analyzer unnecessarily to extreme temperatures, moisture, shocks, blows or vibration.

Unpacking the Moisture Analyzer

- After unpacking the equipment, please check it immediately for any visible damage
- If any sign of damage is visible, proceed as directed under “Safety Inspection” in the chapter entitled “Care and Maintenance.”

It is a good idea to save the box and all parts of the packaging until you have successfully installed your equipment. Only the original packaging provides the best protection for shipment. Before packing your moisture analyzer, unplug all connected cables to prevent damage.

Equipment Supplied

The equipment supplied includes the components listed below:

- Moisture analyzer
- Power cord
- Pan support
- Pan draft shield
- 80 disposable aluminum sample pans
- 1 pair of forceps

Installation Instructions

The MA35 moisture analyzer is designed to provide reliable results under normal ambient conditions in the laboratory and in industry. When choosing a location to set up your analyzer, observe the following so that you will be able to work with added speed and accuracy:

- Set up the moisture analyzer on a stable, even surface that is not exposed to vibrations, and level it using the four leveling feet
- Avoid placing the moisture analyzer in close proximity to a heater or otherwise exposing it to heat or direct sunlight
- Avoid exposing the moisture analyzer to extreme temperature fluctuations
- Protect the moisture analyzer from drafts that come from open windows or doors
- Keep the moisture analyzer protected from dust, whenever possible
- Protect the moisture analyzer from aggressive chemical vapors
- Do not expose the equipment to extreme moisture over long periods
- Make sure to choose a place where excessive heat cannot build up. Leave enough space between the moisture analyzer and materials that are affected by heat.

Conditioning the Moisture Analyzer

Moisture in the air can condense on the surfaces of a cold moisture analyzer whenever it is brought into a substantially warmer place. If you transfer the moisture analyzer to a warmer area, condition it for about 2 hours at room temperature, leaving it unplugged from AC power. Afterwards, if you keep the moisture analyzer connected to AC power, the constant positive difference in temperature between the inside of the equipment and the outside will practically rule out the effects of moisture condensation.

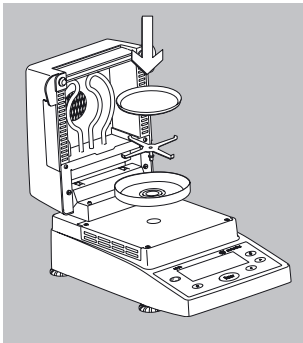

Setting up the Moisture Analyzer

- Position the components listed below in the order given:
 - Pan draft shield
 - Pan support
 - Disposable sample pan

Connecting the Moisture Analyzer to AC Power

- Check the voltage rating and the plug design
- The heating element has been factory-set to 230 V or 115 volts for technical reasons. The voltage has been set as specified on your order. The voltage setting is indicated on the manufacturer's label (see the bottom of the analyzer), for example:
 - 230 volts: MA35-...230..
 - 115 volts: MA35-...115..



If the voltage indicated on the label does not match your local line voltage:
Do not operate your moisture analyzer; contact your local Sartorius office or dealer.

Use only

- Genuine Sartorius power cords, or
- Power cords approved by a certified electrician
- If you need to connect an extension cord, use only a cable with a protective grounding conductor

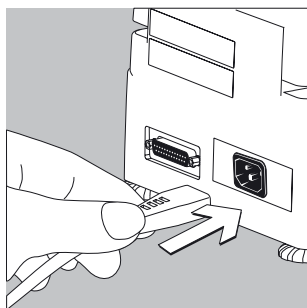

- Connecting the moisture analyzer, rated to Class 1, to AC power (mains supply):
Plug the power cord into an electrical outlet (mains supply) that is properly installed with a protective grounding conductor (protective earth = PE)

Safety Precautions

If you use an electrical outlet that does not have a protective grounding conductor, make sure to have an equivalent protective conductor installed by a certified electrician as specified in the applicable regulations for installation in your country. Make sure the protective grounding effect is not neutralized by use of an extension cord that lacks a protective grounding conductor.

Connecting Electronic Peripheral Devices

- Make absolutely sure to unplug the analyzer from AC power before you connect or disconnect a peripheral device (printer or PC) to or from the interface port.

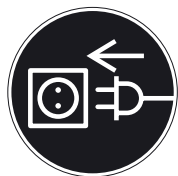

NOTE: This equipment has been tested and found to comply with the limits pursuant to part 15 of FCC Rules.

These limits are designed to provide reasonable protection against harmful interference. This equipment generates, uses and can radiate radio frequency energy and, if not installed and used in accordance with these instructions, may cause harmful interference to radio communications.

For information on the specific limits and class of this equipment, please refer to the Declaration of Conformity. Depending on the particular class, you are either required or requested to correct the interference.

If you have a Class A digital device, you need to comply with the FCC statement as follows: "Operation of this equipment in a residential area is likely to cause harmful interference in which case the user will be required to correct the interference at his own expense."

If you have a Class B digital device, please read and follow the FCC information given below:

"However, there is no guarantee that interference will not occur in a particular installation. If this equipment does cause harmful interference to radio or television reception, which can be determined by turning the equipment off and on, the user is encouraged to try to correct the interference by one or more of the following measures:

- Reorient or relocate the receiving antenna.
- Increase the separation between the equipment and receiver.
- Connect the equipment into an outlet on a circuit different from that to which the receiver is connected.
- Consult the dealer or an experienced radio/TV technician for help."

Before you operate this equipment, check which FCC class (Class A or Class B) it has according to the Declaration of Conformity included. Be sure to observe the information of this Declaration

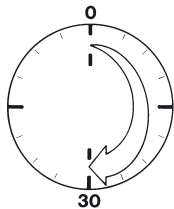

Warmup Time

To deliver exact results, the moisture analyzer must warm up for at least 30 minutes every time you connect it to AC power or after a relatively long power outage.

Only after this time will the analyzer have reached the required operating temperature.

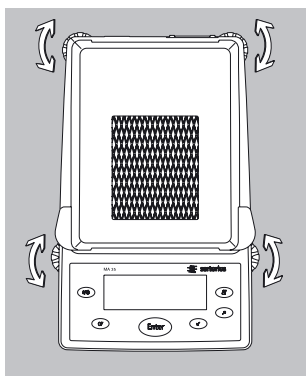

Leveling the Moisture Analyzer

Purpose:

- To compensate for unevenness at the place of installation
- This is particularly important for testing liquid samples, which must be at a uniform level in the sample pan

Always level the moisture analyzer again any time after it has been moved to a different location.

- Extend or retract the front and/or rear leveling feet as needed to adjust the moisture analyzer

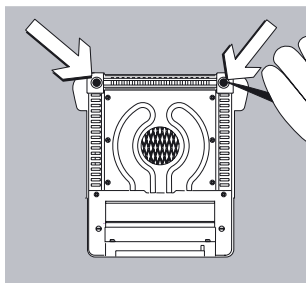

Installing the Aluminum Panels (Optional; Part No. YDS05MA)

- △ To prevent burns, allow the glass panels to cool sufficiently before removing them

- △ Do not handle the aluminum panels with oily or greasy fingers

- △ Do not scratch the aluminum panels; do not use abrasive or corrosive substances to clean the aluminum panels

- Remove the 2 rubber caps and the 2 screws beneath them, and then remove the panel retainer

- Remove the glass panels

- Position the aluminum panels in the retainer

- Fasten the aluminum panels with the retainer and screws; replace the 2 rubber caps

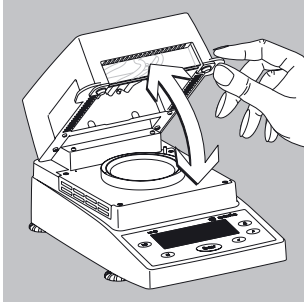

Turning On the Analyzer; Opening and Closing the Sample Chamber

- To turn on the analyzer: press 
- When opening or closing the sample chamber, do not release the cover until it is in the fully open or fully closed position

Operating Design

Operation of the moisture analyzer follows a standardized “philosophy” which is described below.

There is only one key to a function, i.e., the key retains this function throughout most of the menu levels. The texts and symbols shown always have the same meaning.

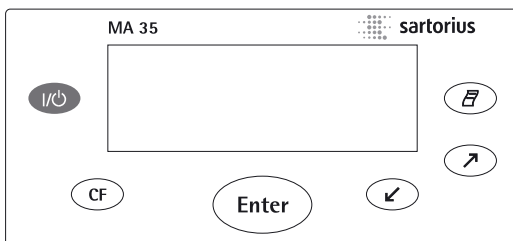

Keys

Some of the keys trigger different functions, depending on whether you press the key briefly or press and hold the key:

- Press briefly = hold the key down for less than 1.2 seconds
- Press and hold = hold the key down for more than 1.2 seconds
- If you press and hold longer than 1.2 seconds, the function triggered is repeated every 0.6 seconds for as long as you hold the key.

Key	Designation	Press briefly	Press and hold
	On/off key	Switch device on or off*	–
	CF key	Analysis: cancel function Menu: cancel selection	–
	Enter key	Analysis: trigger the selected function (e.g., tare) Menu: store the selected setting	Menu: store the selected setting and tare) close the menu
	Down/Back key	Analysis: select a function (e.g., tare) Menu: decrease value or return to previous selection	Menu: decrease value 10-fold
	Up/Forward key	Analysis: select a function (e.g., tare) Menu: increase value or go to next selection	Menu: increase value 10-fold
	Print key	Send readout value or data record over the interface port	–

* When you switch off the moisture analyzer, it remains in standby mode

Display

The texts and symbols shown on the display always have the same meaning. The display is divided into several areas.

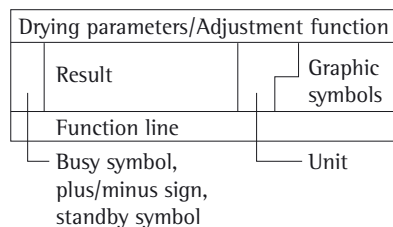



Drying parameters:

The following symbols indicate drying program parameters for information, selection and configuration:

 120°C Target temperature

 40 min Drying time
A Fully automatic

 g Weight unit or unit
for a calculated value

 A Analysis start

 2.0 min Interval for automatic
output of intermediate
results

Adjustment function:

P b Adjustment function

Busy symbol, plus/minus sign, standby symbol:

The  symbol is shown here when the moisture analyzer is processing a function. The plus/minus sign for the weight value or calculated value appears here as well, and the standby symbol when the device is switched off.

Result:

This section shows the weight or calculated value.

Unit:

When the weighing system stabilizes, the unit of measurement for the weight or calculated value is displayed here.

Graphic symbols:

Which symbol is shown here depends on the operating status of the analyzer. The examples below indicate “Please close hood,” “Heating the sample” and “Please wait” (hourglass).

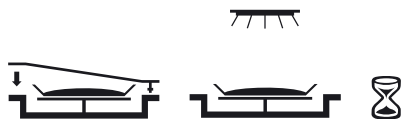

Function line:

Press the Down/Back or Up/Forward keys to move the focus and select one of the functions shown here, and the Enter key to activate the selected function:

CAL SET PRG END START TAR







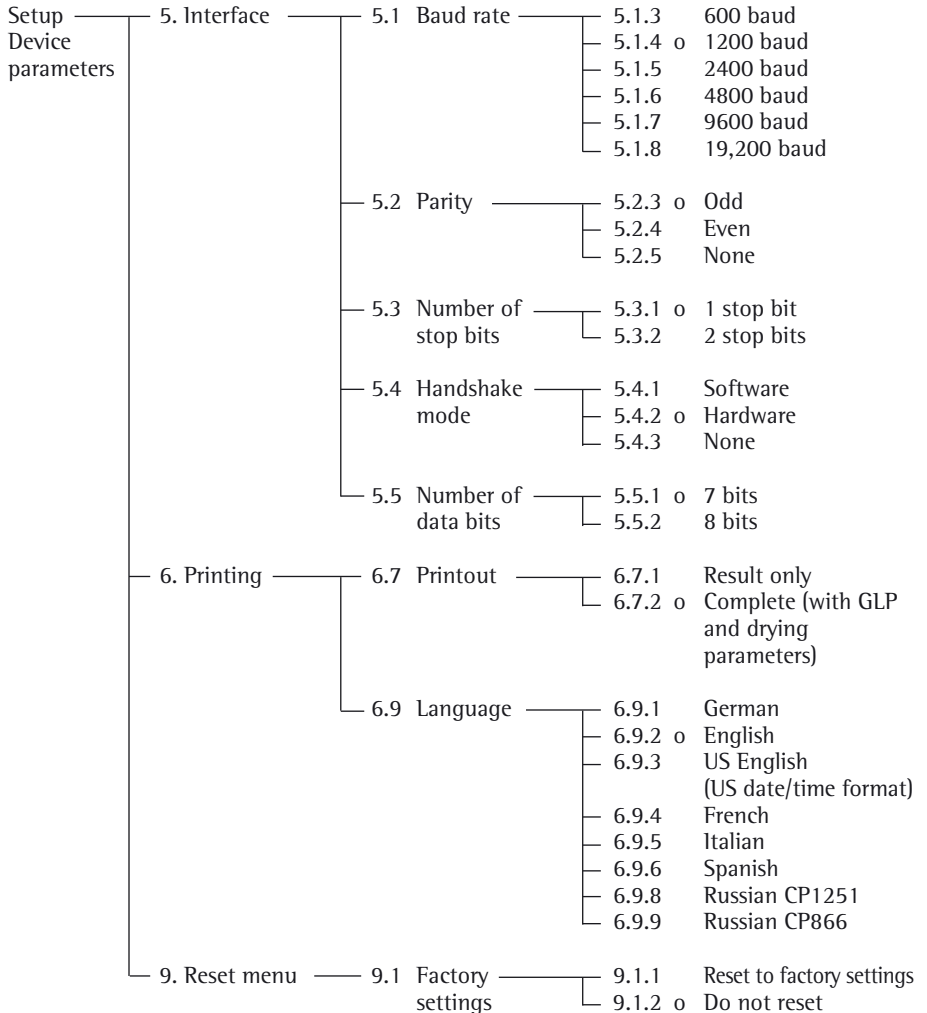



Configuration

Setting the Device Parameters

- o Factory setting
- √ User-defined setting

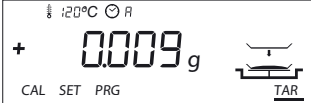

Example
Changing the language to US mode (menu item 6.9.3)

Step	Key (or instruction)	Display
1. Select SET in the function line	Repeatedly: 	
2. Confirm SET		5.
3. Select menu item 6		6.
4. Open submenu		6.7
5. Select menu item 6.9		6.9
6. Open submenu		6.9.2°
7. Select menu item 6.9.3		6.9.3
8. Confirm menu item 6.9.3		6.9.3°
9. Close the Setup menu	Repeatedly: 	

Setting the Drying Parameters

Select PRG in the function line to adapt parameters for the drying program to the particular requirements of the product sampled.

Drying Parameters

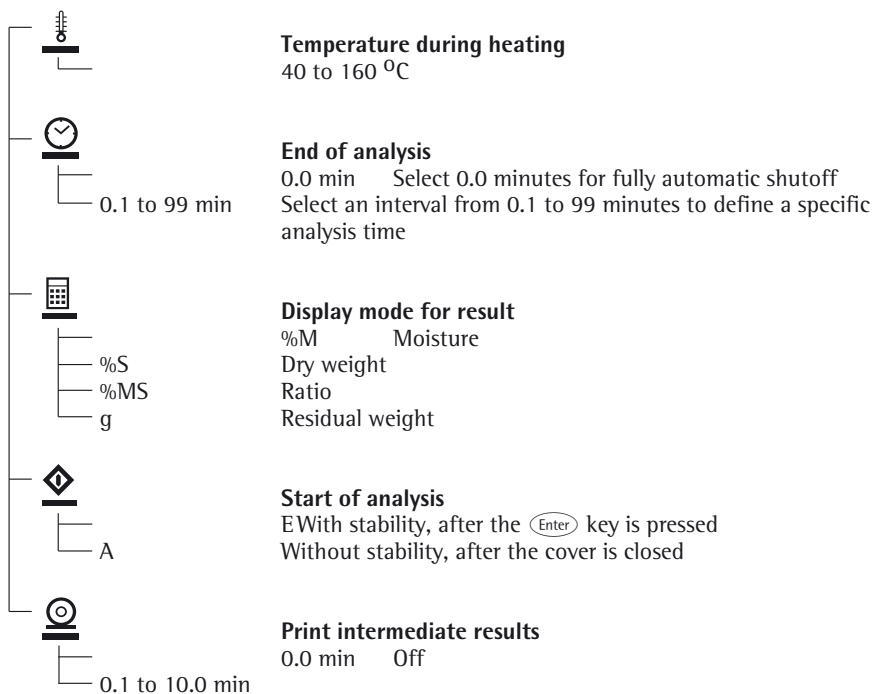

Features

Temperature during heating

- Adjusted to defined specified temperature during the analysis process

Start of analysis

- With stability after the **Enter** key is pressed:
When START is shown in the function line and you press **Enter** to confirm, the initial weight is stored at stability regardless of whether the cover is open or closed.
Measurement begins as soon as the cover is closed.
- Without stability after the cover is closed:
A symbol shown in the graphic symbol display prompts you to close the cover once the initial weight condition is met.
The initial weight is stored without stability as soon as the sample chamber is closed, and analysis begins.

End of Analysis with Shutoff Parameters

- Fully automatic mode
- Timer mode

Fully automatic mode:

Use the fully automatic mode when loss of weight on drying follows a clearly delineated curve which can be unambiguously evaluated (see below).

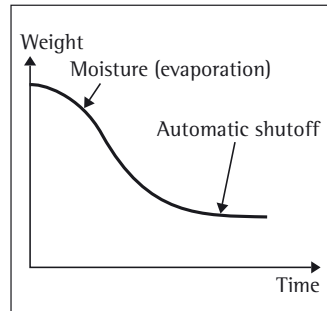

Timer mode:

The analysis ends as soon as the specified time has elapsed.

Display Mode for Result

The following units can be selected for displaying analysis results:

- Moisture %M
- Dry weight %S
- Ratio %MS
- Residual weight g

Print Intermediate Results

Intermediate results can be printed either at user-definable intervals or by pressing the **Print** key.















Example: setting the following drying parameters













Final temperature: 130 °C

Start of analysis: without stability after the cover is closed

End of analysis: after 10 minutes

Display mode for result: moisture

Step	Key (or instruction)	Display
1. Turn on the analyzer		Self-test runs 
2. Select PRG: drying program parameters		<u>PRG</u>
3. Confirm PRG (the previously set temperature is displayed; in this example, 105°C)		 105°C
4. Set the heating temperature (in this example: 130°C)	 repeatedly	 130°C
5. Confirm heating temperature (the previously set analysis time is displayed; in this example, 0.0 min)		 0.0 min
6. Set the parameter for the end of analysis; in this example, 10 minutes)	 repeatedly	 10 min
7. Confirm the “end of analysis” parameter		
8. Select the result display mode (in this example, moisture)	 or 	%M

Step	Key (or instruction)	Display
9. Confirm the display mode		 <i>E</i>
10. Select the start parameter (in this example, W/o stability after the cover is closed)	 or 	 <i>A</i>
11. Confirm the start parameter		 <i>10 min</i>
12. Select setting for printout of intermediate results (in this example, no printout = 0.0)	 repeatedly	 <i>0.0 min</i>
13. Confirm setting for intermediate printout of results		 <i>130°C</i>
14. Save changes and exit menu for drying parameter input	 > 2 sec	

Operation

Example: Analysis with Specified Drying Time











The specified drying time in the example is 10 minutes.

Final temperature: 130 °C

Start of analysis: Without stability after the cover is closed

End of analysis: After 10 minutes

Display mode: Moisture

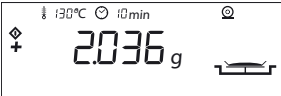
Step	Key (or instruction)	Display
1. Switch on the moisture analyzer		Self-test runs 
2. Set the drying parameters (see "Setting the Drying Parameters" in the chapter entitled "Configuration")		
3. Open the sample chamber and place an unused sample pan on the pan support		
4. Tare the sample pan: select TAR ...and confirm	 or  as needed 	
5. Distribute approx. 2 g sample evenly on the sample pan		
6. Close the sample chamber		

The printout header is printed: see next page

Step	Key (or instruction)	Display
------	----------------------	---------

The printout header is printed

```

-----
23.08.2005      11:25 *)
Model MA35-000230V1
Ser. no.      99992581
Ver. no.      00-33-01
ID
-----
Temp.          130 °C
Start          W/O STABI.
End            10.0 min
IniWt +       2.036 g
-----

```

*) Date and time included only if a Sartorius printer model YDP02 or YDP03 is used

Current moisture loss and elapsed time are displayed (in this example, 0.36% moisture after 0.3 min)

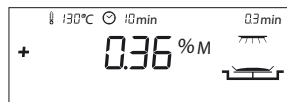

Drying stops automatically after 10 minutes

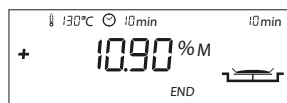

The footer of the printout is printed

```

-----
10.0 +         10.90 %M
FinWt +        1.814 g
Name:
-----

```



You can print the result as often as you wish by pressing . Printout when function canceled: ("B" stands for "Break")

```

-----
10.0 +         10.90 %M
B 5.7 +        0.03 %M
-----

```

7. Clear the display 

During and after the analysis you can change the mode for display and printout of results at any time by pressing the  and  keys.

Adjusting the Analyzer

Heating Element Adjustment

The procedure for adjusting the heating element is described in the instructions supplied with the YTM01MA temperature adjustment set.

Weighing System Adjustment

To adjust the weighing system, perform calibration and adjustment as described in the following.

Purpose

Calibration is the determination of the difference between the weight readout and the true weight (mass) of a sample. Calibration does not entail making any changes within the weighing system.

Adjustment is the correction of the difference between the measured value displayed and the true weight (mass) of a sample, or the reduction of the difference to a level within specified permissible error limits.













Features



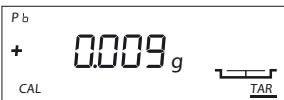

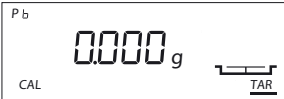

Calibration is performed externally with the following weight value:

- MA35: 30 g; see “Accessories,” order no. YSS43

You can have calibration and adjustment results documented as a ISO/GLP-compliant printout (see the page after next for an example).

External Calibration and Adjustment with a Factory-Defined Weight
Externally calibrate and adjust the weighing system using a 30-g calibration weight.

Step	Key (or instruction)	Display
1. Turn on the analyzer		<p>Self-test runs</p> 
2. Select CAL for calibration/adjustment		
3. Confirm CAL		
4. Confirm again when <i>Pb</i> is shown		
5. Tare the weighing system		
6. Select CAL again		
7. Confirm CAL		

Step	Key (or instruction)	Display
The prompt for calibration weight is displayed		
8. Open the hinged cover		
9. Place the 30-weight on the weighing system Minus sign -: weight value too low Plus sign +: weight value too high No sign: weight value OK		
The weight unit symbol (g) is displayed at the end of adjustment		
Printout after calibration and adjustment		<pre>----- 23.08.2005 10:51 *) Model MA35-000230V1 Ser. no. 99992581 Ver. no. 00-33-01 ID</pre>
*) Date and time included only if a Sartorius printer model YDP02 or YDP03 is used		
		<pre>----- External calibration W-ID Nom. + 30.000 g Diff. + 0.001 g External adjustment Diff. + 0.000 g completed -----</pre>
		<pre>Name :</pre> <pre>-----</pre>
10. Unload the analyzer Close the cover		
11. Quit calibration/adjustment		

Interface Port

Purpose

The moisture analyzer has an interface port for connecting an external printer or computer (or other peripheral device).

External Printer

You can use an external printer to generate printouts.

Computer

Analyses and calculated values can be transmitted to a computer for further evaluation and for documentation.

Warning When Using Pre-wired RS-232 Connecting Cables:

RS-232 cables purchased from other manufacturers often have pin assignments that are incompatible with Sartorius products. Be sure to check the pin assignments against the chart on the next page before connecting the cable, and disconnect any lines identified differently from those specified by Sartorius (e.g., pin 11). Failure to do so may damage or even completely ruin your moisture analyzer and/or peripheral device(s).

Preparation

For instructions on adapting the interface port to the peripheral device, please refer to the chapter entitled “Configuration.”

To get the most from the versatile characteristics of your moisture analyzer with regard to documentation of results, we recommend connecting a printer from Sartorius. The resulting printouts will contribute decisively to simplifying GLP-compliant practices.

Female Interface Connector
25-position D-Submini (DB25S) with
screw lock hardware for cable gland

Required Male Connector
25-pin D-Submini (DB25S) with shielded
cable clamp assembly (Amp type 826 985-1C)
and fastening screws (Amp type 164 868-1).

Pin assignments in the 25-contact
RS-232 female connector

- Pin 1: Signal ground
- Pin 2: Data output (TxD)
- Pin 3: Data input (RxD)
- Pin 4: Not connected
- Pin 5: Clear to send (CTS)
- Pin 6: Not connected
- Pin 7: Internal ground (GND)
- Pin 8: Not connected
- Pin 9: Not connected
- Pin 10: Not connected
- Pin 11: Rechargeable battery: charge voltage
+10 V (1 _out 25 mA)
- Pin 12: Reset _Out *)
- Pin 13: +5 V output
- Pin 14: Internal ground (GND)
- Pin 15: Not connected
- Pin 16: Not connected
- Pin 17: Not connected
- Pin 18: Not connected
- Pin 19: Not connected
- Pin 20: Data terminal ready (DTR)
- Pin 21: Not connected
- Pin 22: Not connected
- Pin 23: Not connected
- Pin 24: Not connected
- Pin 25: +5 V output

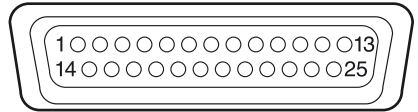

*) = Peripheral device restart

Error Codes

Error codes are displayed dynamically, for 2 seconds, or permanently. After a code is displayed dynamically or for 2 seconds, the program returns automatically to the normal operating mode.

Display	Cause	Solution
<i>H</i>	The load exceeds the weighing	Unload the pan support capacity
<i>L</i> or <i>Err 54</i>	Load is below the weighing range	Place the pan support on the weighing system
<i>Err 01</i>	Data output not compatible with output format	Change the configuration in the Setup menu
<i>Err 02</i>	Calibration/adjustment condition not met, e.g., – not tared – the pan support is loaded	Calibrate only when zero is displayed Select TAR to tare Unload the moisture analyzer
<i>Err 03</i>	Calibration/adjustment could not be completed within a certain time	Allow the scale to warm up again and repeat the adjustment
<i>Err 30</i>	Interface port for printer output is blocked	Have the port setting changed by Sartorius Customer Service
<i>Err 31</i>	Peripheral device not responding (interface handshake interrupted; XOFF, CTS)	Send XON, release CTS
<i>Err 50</i>	Temperature compensation overflow/underflow	Contact your local Sartorius Service Center
<i>Err 53</i>	Temperature compensation not functioning	Contact your local Sartorius Service Center
<i>Err 55</i>	Output from weighing ADC too high	Contact your local Sartorius Service Center
<i>Err 79</i>	Dryer adjustment data not found	Contact your local Sartorius Service Center
<i>Err 241</i> , <i>Err 243</i>	Weighing system parameters (EEPROM) defective	Switch the analyzer off and then on again. If the error persists, contact your local Sartorius Service Center
<i>Err 2xx</i>	Internal error	Contact your local Sartorius Service Center
<i>Err 340</i>	Operating parameters (EEPROM) incorrect	Contact your local Sartorius Service Center
<i>Err 342</i>	Operating parameters (EEPROM) incorrect except adjustment parameters	Contact your local Sartorius Service Center

If any other errors occur, contact your local Sartorius Service Center.

Contact information: Please point your Internet browser to: <http://www.sartorius.com>

Care and Maintenance

Service

Regular servicing by a Sartorius technician will extend the service life of your analyzer and ensure its continued accuracy of measurement. Sartorius can offer you service contracts, with your choice of regular maintenance intervals ranging from 1 month to 2 years.

The optimum length of the service interval depends on the operating conditions at the place of installation and on your requirements.

Repairs

Repair work must be performed by trained service technicians. Any attempt by untrained persons to perform repairs may result in considerable hazards for the user.

Cleaning



Make sure that no dust or liquid enters the moisture analyzer housing



Do not use any aggressive cleaning agents (solvents, abrasive cleaning agents, etc.); clean the moisture analyzer using a piece of cloth which has been wet with a mild detergent (soap) only

- Disconnecting the power supply: unplug the power cord from the wall outlet (mains supply); if you have a cable connected to the interface, unplug it from the moisture analyzer
- The pan draft shield and the pan support can be removed for cleaning
- Carefully remove any sample residue/spilled powder using a brush or a handheld vacuum cleaner
- After cleaning, wipe down the analyzer with a soft, dry cloth

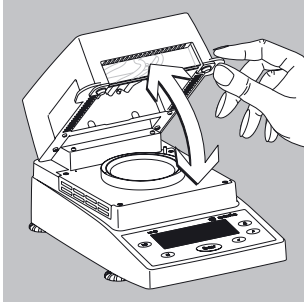

Cleaning the Heating Unit and Temperature Sensor

- Open the hinged cover

 **Danger:** The terminals of the heating unit are under live current

- Disconnect the power supply by unplugging the power cord from the wall outlet (mains)
If you have a cable connected to the interface port, disconnect it from the moisture analyzer

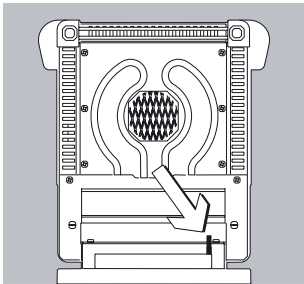

- Carefully remove any residue from the temperature sensor

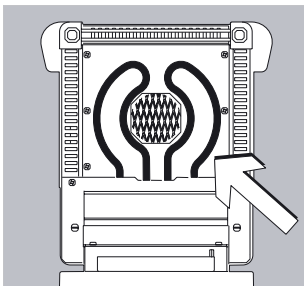

- Use a brush or a damp, lint-free cloth to clean the tubular metal heating element.

Safety Inspection

If there is any indication that safe operation of the equipment is no longer warranted:

- Disconnect the power supply by unplugging the power cord from the wall outlet (mains)
 - > Lock the equipment in a secure place to ensure that it cannot be used for the time being
- Safe operation of the equipment is no longer ensured when:
- there is visible damage to the device or power cord,
 - the analyzer no longer functions properly,
 - the equipment has been stored for a relatively long period under unfavorable conditions, or
 - the equipment has been subjected to rough handling during shipment.

In this case, notify your nearest Sartorius Service Center. Maintenance and repair work may be performed only by service technicians who are authorized by Sartorius and who:

- have access to the required service and maintenance manuals, and
- have attended the relevant service training courses.

We recommend having the moisture analyzer inspected regularly according to the following checklist by a qualified Sartorius service technician:

- Resistance of the protective grounding conductor < 0.2 ohm measured with a commercially available multimeter
- Insulation resistance > 2 megaohms measured with a constant voltage of at least 500 volts at a 500 kohm load

A qualified Sartorius service technician should determine which tests are performed at what intervals, based on ambient and operating conditions. Inspections must be performed at least once a year.

Recycling



If you no longer need the packaging after successful installation of the equipment, you should return it for recycling. The packaging is made from environmentally

friendly materials and is a valuable source of secondary raw material. Batteries are hazardous waste and must be disposed of separately. Please deposit empty batteries in the collection boxes set up in your area for this purpose. On request, Sartorius can provide GRS boxes for collecting used batteries (GRS stands for “Gemeinsames Rücknahme System,” a German organization for battery disposal). Contact your local waste disposal authorities if you wish to scrap the equipment. Remove batteries before scrapping the equipment. Sartorius in Goettingen will take back equipment and packaging for disposal in accordance with the applicable laws.*

* This service is offered only within Germany. If you set up the equipment in a country other than Germany, please contact your local waste disposal authorities for information on similar services.

Overview

Specifications

Weighing capacity (Max)	35 g
Accuracy of the weighing system	1 mg
Repeatability (average)	from about 1 g initial sample: $\pm 0.2\%$ from about 5 g initial sample: $\pm 0.05\%$
Readability	0.01 %
Display of results	% moisture % dry weight % ratio g residual weight
Shutoff criteria	Fully automatic Timer mode: 0.1 to 99 min
Sample heating	Infrared radiation from a tubular metal heating element
Access to sample chamber	Flip-open cover with wide-angle opening
For conformity with FDA/HACCP regulations	Aluminum panels (in place of glass panels)
Operating temperature range and setting	40°C to 160°C (104°F to 320°F), adjustable in 1°C increments
Operator guidance	Symbols
Program memory capacity	1 program
Measured value memory capacity	Final value stored until subsequent measurement begins
Printout of measured values	Short printout GLP-compliant record in German, English, French, Italian, Spanish or Russian
Interface port	RS-232C, 25-pin connector for transfer of values to a printer or computer
Housing dimensions in mm	Width 224, depth 366, height 191
Net weight, approx.	5.8 kg
Power requirements (supply voltage):	230 V or 115 V (depending on the model) (-15% ... +10%); 50 – 60 Hz
Frequency	48 – 60 Hz
Fuses	2 (zero conductor/phase), 6.3 A, time-lag (slow-blow), 5 × 20 mm (internal)
Power consumption	400 VA
Ambient conditions:	
Operating temperature range:	+10 ... +30°C (+50° ... +86°F)
Allowable ambient operating temperature:	+5°C ... +40°C (+41°F ... +104 °F)
Ambient storage temperature:	-20°C ... +70°C (-4°F ... +158°F)
Relative humidity:	Up to 80% at +31°C (+ 88°F) ambient temperature; linearly decreasing down to 50% at +40°C (+104°F), non-condensing
Operating altitude	For use above sea level up to 2,000 m (6,562 feet); indoor use only

Accessories (Options)

Accessories	Order No.
80 disposal sample pans Aluminum; 90 mm Ø	6965542
80 glass fiber filters For liquid and pasty samples and samples with high fat-content	6906940
Exchangeable panels for flip-open cover Replaces glass with aluminum panels for compliance with FDA/HACCP regulations (upgrade kit)	YDS05MA
Model YDP20-OCE data printer for external connection	YDP20-OCE
Color ink ribbon for YDP20-OCE data printer	6906918
Paper for YDP20-OCE data printer; 5 rolls; length: 50 m	6906937
External calibration weight 30 g ± 0.3 mg	YSS43
Temperature adjustment set	YTM01MA
Standard Operating Procedure (SOP)	YSL02MA

Declaration of Conformity



CE EG-Konformitätserklärung EC Declaration of Conformity

Sartorius Weighing Technology GmbH
Weender Landstrasse 94 - 108
D-37075 Goettingen, Germany

erklärt, dass das Betriebsmittel
declares that the equipment

Geräteart: **Feuchtebestimmer**
Device type: Moisture analyzer
Baureihe / Type series: **MA35M-..., MA100-..., MA150-..., LMA200PM-...**

in der von uns in Verkehr gebrachten Ausführung mit den grundlegenden Anforderungen der folgenden Europäischen Richtlinien übereinstimmt:
in the form as delivered complies with the basic requirements of the following European Directives:

Richtlinie 2004/108/EG **Elektromagnetische Verträglichkeit**
Directive 2004/108/EC Electromagnetic compatibility
Richtlinie 2006/95/EG **Elektrische Betriebsmittel zur Verwendung innerhalb bestimmter Spannungsgrenzen**
Directive 2006/95/EC Electrical equipment designed for use within certain voltage limits

Das Gerät erfüllt die anwendbaren Anforderungen folgender harmonisierten Europäischen Normen.
The apparatus meets the applicable requirements of the harmonized European Standards listed below.

1. Richtlinie 2004/108/EG | *Directive 2004/108/EC*
EN 61326-1:2006 **Elektrische Mess-, Steuer-, Regel- und Laborgeräte - EMV-Anforderungen - Teil 1: Allgemeine Anforderungen (IEC 61326-1:2005)**
Electrical equipment for measurement, control and laboratory use - EMC requirements - Part 1: General requirements (IEC 61326-1:2005)
2. Richtlinie 2006/95/EG | *Directive 2006/95/EC*
EN 61010-1:2001 **Sicherheitsbestimmungen für elektrische Mess-, Steuer-, Regel- und Laborgeräte - Teil 1: Allgemeine Anforderungen (IEC 61010-1:2001)**
Safety requirements for electrical equipment for measurement, control, and laboratory use - Part 1: General requirements (IEC 61010-1:2001)

Jahr der Anbringung der CE-Kennzeichnung | *Year of attachment of CE marking:* **11**

Sartorius Weighing Technology GmbH
Goettingen, 2011-11-03

Dr. Reinhard Baumfalk
Vice President R&D

Dr. Dieter Klausgrete
Leitung International Certification Management
Head of International Certification Management

Diese Erklärung bescheinigt die Übereinstimmung mit den genannten EG-Richtlinien, ist jedoch keine Zusicherung von Eigenschaften. Bei einer mit uns nicht abgestimmten Änderung des Produktes verliert diese Erklärung ihre Gültigkeit. Die Sicherheitshinweise der zugehörigen Produktdokumentation sind zu beachten.
This declaration certifies conformity with the above mentioned EC Directives, but does not guarantee product attributes. Unauthorised product modifications make this declaration invalid. The safety information in the associated product documentation must be observed.

SWT11CE017

65711-000-58

SOP-3.RD-045-fo2

Sartorius Weighing Technology GmbH
Weender Landstrasse 94-108
37075 Goettingen, Germany

Phone +49.551.308.0
Fax +49.551.308.3289
www.sartorius.com

Copyright by Sartorius,
Goettingen, Germany.

No part of this publication may be
reprinted or translated in any form or
by any means without prior written
permission from Sartorius.

All rights reserved by Sartorius in
accordance with copyright law.

The information and figures contained
in these instructions correspond
to the version date specified below.

Sartorius reserves the right to make
changes to the technology, features,
specifications and design of the
equipment without notice.

Status:

February 2012,
Sartorius Weighing Technology GmbH,
Goettingen, Germany