

## Table of Contents

<b>1</b>	<b>Valid for Load Cells</b> .....	<b>2</b>
<b>2</b>	<b>Preamble</b> .....	<b>2</b>
<b>3</b>	<b>Equipment Function</b> .....	<b>2</b>
3.1	Details.....	2
3.1.1	Calculation of the li value with calculation programs .....	2
3.2	Connection of the Standard Version .....	2
3.2.1	Examples of suitable circuits with approved safety barriers:.....	3
3.3	Connections of the 6-wire Version .....	3
3.4	Advice for Interconnections .....	4
3.5	Coding of the Load Cells .....	4
3.6	Reference notes concerning electrostatics .....	4
3.7	Further Parameters .....	5
<b>4</b>	<b>Designation</b> .....	<b>5</b>
4.1	Standard Label .....	5
4.2	Categorie - Designation.....	5
<b>5</b>	<b>Commissioning and Installation</b> .....	<b>5</b>
<b>6</b>	<b>Usage</b> .....	<b>6</b>
<b>7</b>	<b>Maintenance</b> .....	<b>6</b>
<b>8</b>	<b>Repair</b> .....	<b>6</b>
<b>9</b>	<b>Waste Disposal</b> .....	<b>6</b>
<b>10</b>	<b>EC-Declaration of Conformity / EU-Declaration of Conformity</b> .....	<b>7</b>
<b>11</b>	<b>EC- Type Examination Certificate</b> .....	<b>8</b>

	issued	changed	checked	released
Date	30.06.2004	15.02.2022	03.02.2015 (up to Rev.9.6)	15.02.2022
Signatures	<i>Greulich</i>	<i>Sumowski</i>	<i>Kämper</i>	<i>Hofmann</i>

## 1 Valid for Load Cells

BK2, PC1, PC2, PC2H, PC6, PC7, PC12, PC22, PC42, PC46, PC60, PCB, Q50, RC1, RC2, RC3, SB2, SB4, SB5, SB6, SB8, SB14, SLB, UB1, UB5, UB6, ULB, ZLB

## 2 Preamble

This manual covers only the “Ex” relevant aspects.

## 3 Equipment Function

Flintec load cells are designed to be used in various kinds of industrial scales and meet the most stringent accuracy requirements. These load cells are available with different maximum capacities and include accuracy classifications according to OIML R 60 and / or NTEP.

They offer stainless steel or aluminium construction sealed by welding or improved potting. This makes them suitable for use in tough industrial environments.

The load cells can be used in all hazardous areas. The basic structure is always the same.

All standard equipment is provided with a 4-wire shielded conductor cable; equipment with the coding extension –6w is provided with a 6-wire shielded conductor cable. (See Chapter 2.5 Coding of Load Cells)

### 3.1 Details

The following table shows the relationship between maximum total power  $P_i$  and maximum ambient temperature.

Temperature class / coding	$U_i = 30 \text{ V}, P_i = 4 \text{ W}$
T6 (gas)	$-40^\circ\text{C} \leq T_a \leq 45^\circ\text{C}$
T5 (gas)	$-40^\circ\text{C} \leq T_a \leq 60^\circ\text{C}$
T100°C (dust)	$-40^\circ\text{C} \leq T_a \leq 60^\circ\text{C}$

#### 3.1.1 Calculation of the $I_i$ value with calculation programs

Some calculation programs need a value of  $I_i$  to calculate the  $I_o / I_i$  value. However, this is not necessary for Flintec load cells. In this case a value of 2,000mA can be used.

### 3.2 Connection of the Standard Version

Supply circuit: green (+) and black (-)  
Signal circuit: white (+) and red (-)  
Shield yellow and / or metallic

The intrinsically safe circuit including the load cells must be built up with approved safety barriers or switch amplifiers, matching the connected weighing indicator.

### 3.2.1 Examples of suitable circuits with approved safety barriers:

**Warning:** The displayed examples are verified for ignition protection. The specialist who installs the equipment must take responsibility for proper operation in combination with various measuring equipment.

**Example:** With safety barriers for single-ended supply

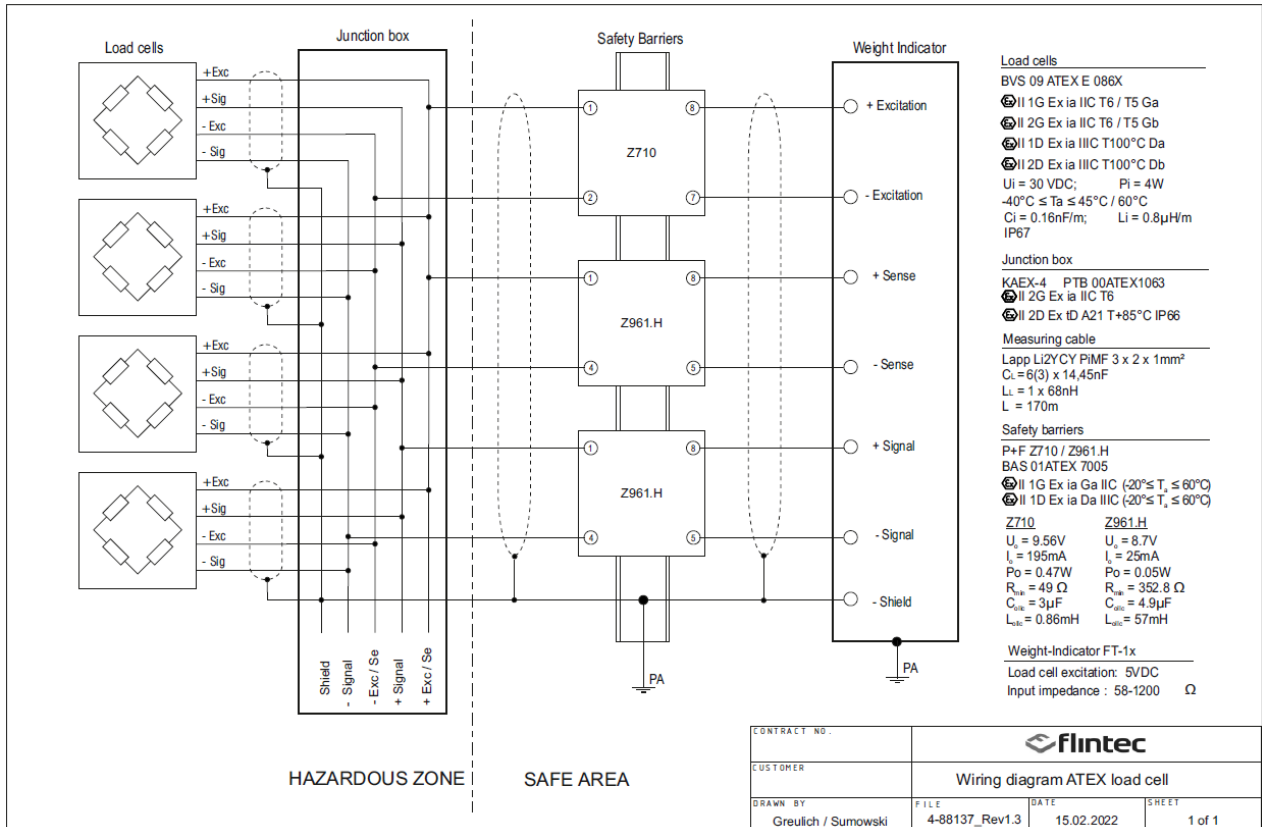

### 3.3 Connections of the 6-wire Version

Supply circuit: green (+) and black (-)  
 Signal circuit: white (+) and red (-)  
 Sense circuit: blue (+) and brown (-)  
 Shield: yellow and / or metallic

The intrinsically safe circuit including the load cells must be built up with approved safety barriers or switch amplifiers, matching the connected weighing indicator.

### 3.4 Advice for Interconnections

- a) Follow and respect the formation-regulations of the application-country.  
E.g. in Germany follow the regulations EN 60079-14.
- b) It is ONLY permitted to use approved safety barriers or switch amplifiers for explosive-areas. In Europe, it is a requirement to have an EC-Type Examination Certificate from a nominated certifying body for the Zones 0 / 1 / 20 / 21.
- c) The rated power,  $P_o$ , of all excitation devices must be equal to or less than the power,  $P_i$ , of one load cell.
- d) The excitation voltage  $U_o$  must be equal to or less than the voltage  $U_i$  of one load cell.
- e) The current,  $I_o$ , of all excitation devices must be equal to or less than the current,  $I_i$ , of one load cell.
- f) The capacitance  $C_o$  and the inductance  $L_o$  must be equal to or more then  $C_i$  and  $L_i$ .
- g) To ensure a potential equalisation with -6w versions, a ground connection between the load cell housing and the safety barrier's ground connector is required. In these installations, the shield of the connection cable is connected to ground potential at both ends.
- h)

### 3.5 Coding of the Load Cells

The load cells have to be marked according to the following scheme:

AAA-BBB-CCC-DDEF-ZZ, e.g. **SB8-100kg-C3-6wsc-12**

AAA	=	Load cell type
BBB	=	Load cell maximum capacity
CCC	=	Accuracy class
DD	=	without marking = 4-wire; 6w = 6-wire
E	=	without marking = screen of cable not connected to load cell body, s = screen of cable connected to load cell body
F	=	without marking = not coated; c = coated
ZZ	=	Cable length in plain text (in meter)

### 3.6 Reference notes concerning electrostatics

The load cells can be covered with a non-conductive protective coating as corrosion prevention. In the type designation code the load cells are marked as "c" in the last position (F).

The free projected surface must not be larger than indicated in the following table after mounting the load cells (types \*\*\*-\*\*\* \*\*-\*c) and propagating brush discharges must be avoided.

Used in:	3.6.1.1.1.1 Max. free projected surface		
	IIA	IIB	IIC
Zone 0	50 cm <sup>2</sup>	25 cm <sup>2</sup>	4 cm <sup>2</sup>
Zone 1 / 2	100 cm <sup>2</sup>	100 cm <sup>2</sup>	20 cm <sup>2</sup>
Zone 20	No limitation of size, but exclusion of propagating brush discharges		
Zone 21 / 22			

If the limiting values of the at maximum tolerable free projected surface cannot be maintained, then mounting can be done by the user (if propagating brush discharges can be eliminated) and he can point to this risk on an ESD- warning label (Clean wet only !) on site and in his explosion protection document. In Zone 2 the installation contractor may permit larger free surfaces on his own responsibility, in accordance with the EX regulations

### 3.7 Further Parameters

- Internal capacitance  $C_i = 0.16 \text{ nF m}^{-1}$
- Internal inductance  $L_i = 0.8 \text{ } \mu\text{H m}^{-1}$

## 4 Designation

All Flintec load cells follow the same electrical design and meet the requirements for category 1 equipment. The operating company must ensure that already used load cells must not be used in other zones except in the same category. Therefore the label has a corresponding checkbox

The ATEX-label is attached to the connection cable close to the load cell body. All allowed designations for this load cell are prepared. The operating company or the specialist who installs the equipment **must** fill in a checkbox with the valid zone by use of a permanent waterproof marker pen or hole punch at site. Without any entry on the label, the load cell is limited for use in zone 2 or 22!

#### 4.1 Standard Label

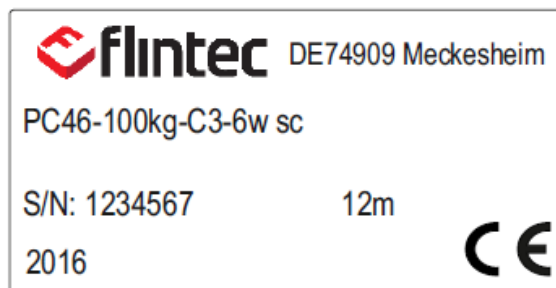

approx. 45 x 28 mm

Mark at this point for use in zone 0 or 20 | →  
- or -

Mark at this point for use in zone 1 or 21 | →

- or -

Mark at this point for use in zone 2 or 22 | →

#### 4.2 Categorie - Designation

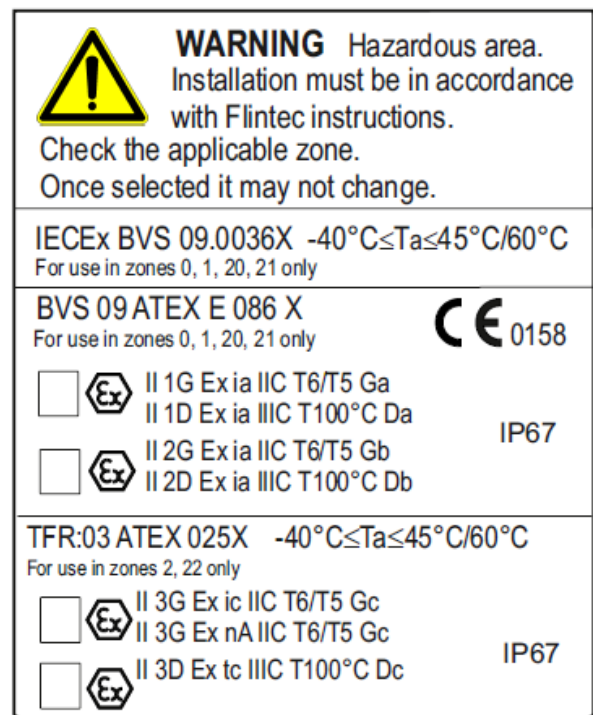

approx. 54 x 44 mm

## 5 Commissioning and Installation

- This equipment (load cells) can be used either in zone 0, 1 or 2, or zone 20, 21 or 22 in explosion groups IIA, IIB, IIC, IIIA, IIIB, or IIIC.
- The allowed ambient temperature range is  $-40^{\circ}\text{C}$  to  $45^{\circ}\text{C}/60^{\circ}\text{C}$ .
- This equipment complies to protection class  $> \text{IP67}$  / EN 60529.
- This equipment must be electro statically grounded.
- The load cell must not be used if it is defective or shows any visible damage.
- Load cells must not be re-used in an intrinsically-safe circuit if they have already been operated in a circuit in zone 2 or 22,

## 6 Usage

**WARNING:** Misuse will cause the loss of warranty and manufacturer's responsibility.

The load cells are only allowed for professional applications in accordance with the load cell data sheet and Flintec application parts.

- a) If the load cells are not, powered from an intrinsically safe circuit the connection cables must either be led out of the hazardous area to terminate them or terminated in suitable junction boxes.
- b) If used in hazardous dust environment, the dust layer on the load cell body must not exceed 5 mm in thickness.
- c) The load cell types PC22, PC42, PC46, PC60 and ZLB have an aluminium housing. If used in zone 0, the general precautions for the application of light metals must be followed.  
For example, Protection against impact energy.
- d) The load cells type BK2, PC1, PC22, PC42, PC46, PC60, SB5, SLB, UB5, ULB and ZLB have a plastic surface > 4 cm<sup>2</sup>. If used in zone 0 precautions against electrostatic charging must be implemented.
- e) In zone 0 and in the apparatus group IIC the connecting cables of the load cells must be laid protected against static charges

## 7 Maintenance

Maintenance interventions on the load cells have to be carried out by Flintec personnel only.

## 8 Repair

This equipment is certified for use in hazardous locations, therefore no modifications are allowed. Repairs **must** only be performed by personnel specifically trained for repairs of this equipment.

## 9 Waste Disposal

The waste disposal of package and shipped parts **must** be done in accordance with the regulations of the country in which the equipment is installed.

## 10 EC-Declaration of Conformity / EU-Declaration of Conformity

### EU-DECLARATION OF CONFORMITY

EC-Declaration of conformity of a sub-assembly  
with the ATEX-Directive 94/9/EC (ATEX95), Amendment X.B  
ATEX-Directive 2014/34/EU (valid from 20 April 2016)

The manufacturer

**Flintec GmbH, Bemannsbruch 9, DE74909 Meckesheim**









Hereby declares that the sub-assembly described below

Description: Load cells of types

**BK2, PC1, PC2, PC2H PC6, PC7, PC12, PC22, PC42, PC46, PC60, PCB, Q50, RC1, RC2, RC3, SB2, SB4, SB5, SB6, SB8, SB14, SLB, BK2, , UB1, UB5, UB6, ULB or ZLB**

Serial numbers see shipping documents

Marking:

		II1G Ex ia IIC T6/T5 Ga	or	II1D Ex ia IIIC T100°C Da or
		II2G Ex ia IIC T6/T5 Gb	or	II2D Ex ia IIIC T100°C Db or
		II3G Ex nA IIC T6/T5 Gc	or	II3D Ex tc IIIC T100°C Dc
		II3G Ex ic IIC T6/T5 Gc		

Complies with the provisions of the following standards:

EN 60079-0:2012	Explosive atmospheres Part 0: Equipment - General requirements
EN 60079-11:2012	Explosive atmospheres Part 11: Equipment protection by intrinsic safety "i"
EN 60079-15:2010	Explosive atmospheres Part 15: Equipment protection by type of protection "n"

Also complies with the following European and National Standards and technical provisions in the version, valid at signature date: Technical rules for the operational safety (TBRS) 2153 Avoidance of ignition hazards as consequence of electrostatic charging.

The sub-assemblies of category 1 and 2 complies with the model, which has obtained an "EC" type certificate, number BVS 09ATEX E 086X issued by the notified body 0158 DEKRA EXAM, Dinnendahlstrasse 9, DE 44809 Bochum.

Flintec GmbH  
Meckesheim, 21-Nov-2016



i.V. Arkadius Sumowski  
Project Manager



## 11 EC- Type Examination Certificate



### Translation

## EC-Type Examination Certificate

- (1) **EC-Type Examination Certificate**
- (2) **- Directive 94/9/EC -**  
**Equipment and protective systems intended for use**  
**in potentially explosive atmospheres**
- (3) **BVS 09 ATEX E 086 X**
- (4) **Equipment:** Load cell type \*\*\*\_\*\*\*\_\*\*\*\_\*\*\*\*
- (5) **Manufacturer:** Flintec GmbH
- (6) **Address:** 74909 Meckesheim, Germany
- (7) The design and construction of this equipment and any acceptable variation thereto are specified in the appendix to this type examination certificate.
- (8) The certification body of DEKRA EXAM GmbH, notified body no. 0158 in accordance with Article 9 of the Directive 94/9/EC of the European Parliament and the Council of 23 March 1994, certifies that this equipment has been found to comply with the Essential Health and Safety Requirements relating to the design and construction of equipment and protective systems intended for use in potentially explosive atmospheres, given in Annex II to the Directive.  
The examination and test results are recorded in the test and assessment report BVS PP 09.2098 EG.
- (9) The Essential Health and Safety Requirements are assured by compliance with:
- |                  |                                     |
|------------------|-------------------------------------|
| IEC 60079-0:2007 | General requirements                |
| EN 60079-11:2007 | Intrinsic safety 'i'                |
| EN 60079-26:2007 | Equipment Protection Level (EPL) Ga |
| EN 61241-0:2006  | General requirements                |
| EN 61241-11:2006 | Intrinsic safety 'iD'               |
- (10) If the sign "X" is placed after the certificate number, it indicates that the equipment is subject to special conditions for safe use specified in the appendix to this certificate.
- (11) This EC-Type Examination Certificate relates only to the design, examination and tests of the specified equipment in accordance to Directive 94/9/EC.  
Further requirements of the Directive apply to the manufacturing process and supply of this equipment. These are not covered by this certificate
- (12) The marking of the equipment shall include the following:



**II 1G Ex ia IIC T6/T5 Ga** resp. **II 2G Ex ia IIC T6/T5 Gb**  
**II 1D Ex ia IIIC IP67 T100°C Da** **II 2D Ex ia IIIC IP67 T100°C Db**

**DEKRA EXAM GmbH**

Bochum, dated 06. July 2009

Signed: Simanski

Signed: Ruhnau

Certification body

Special services unit

Page 1 of 3 to BVS 09 ATEX E 086 X

This certificate may only be reproduced in its entirety and without change

DEKRA EXAM GmbH Dinnendahlstrasse 9 44809 Bochum Germany Phone +49 234/3696-105 Fax +49 234/3696-110 E-mail zs-exam@dekra.com





(13) Appendix to

(14) **EC-Type Examination Certificate**

**BVS 09 ATEX E 086 X**

(15) 15.1 Subject and type

Load cell type \*\*\*\_\*\*\*\_\*\*\*\_\*\*\*\*

Instead of the \*\*\* in the complete denomination letters and numerals will be inserted which characterize modifications:

Type \*\*\*\_\*\*\*\_\*\*\*\_\*\*\*\*

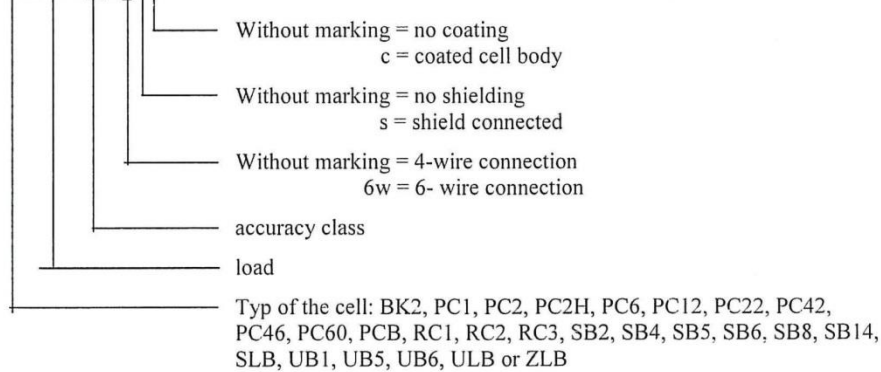

15.2 Description

The load cells are used for converting a load into an electrical signal. The cells have a metal enclosure with inside fixed resistance strain gauges. The electrical connection is carried out by a permanently connected cable. The cells are "simple apparatus".

15.3 Parameters

Voltage	U <sub>i</sub>	DC	30	V
Power	P <sub>i</sub>		4	W
Ambient temperature range for Temperature Class T6	T <sub>a</sub>		-40 °C up to +45 °C	
for Temperature Class T5			-40 °C up to +60 °C	
for Dust application			-40 °C up to +60 °C	

(16) Test and assessment report

BVS PP 09.2098 EG as of 06.07.2009



(17) Special conditions for safe use

- 17.1 The load cells type PC22, PC42, PC46, PC60 and ZLB have an aluminium enclosure; if those cells are used in areas requiring Category 1G apparatus, avoid an ignition hazard due to impact or friction.
- 17.2 The load cells type BK2, PC1, PC22, PC42, PC46, PC60, SB5, SLB, UB5, ULB and ZLB have a plastic surface larger than 4 cm<sup>2</sup>; if those cells are used in areas requiring Category 1G apparatus, avoid risk from electrostatic discharge.
- 17.3 If the load cell is used in areas requiring Category 1G apparatus for gas group IIC, they should be installed in a way that intensive electrostatic charges are avoided.
- 17.4 The load cells type \*\*\*\_\*\*\*\_\*\*\*\_\*\*\*c have a coated cell body; if they are used in areas requiring Category 1D or 2D apparatus, avoid an ignition hazard due to propagating brush discharges.

---

We confirm the correctness of the translation from the German original.  
In the case of arbitration only the German wording shall be valid and binding.

44809 Bochum, 06. July 2009  
BVS-Schu/Her A 20090180

**DEKRA EXAM GmbH**



---

Certification body



---

Special services unit



Translation

# 1. Supplement to the EC-Type Examination Certificate

- (1) Equipment and protective systems intended for use in potentially explosive atmospheres - Directive 94/9/EC Supplement accordant with Annex III number 6
- (2) No. of EC-Type Examination Certificate: **BVS 09 ATEX E 086 X**
- (3) Equipment: **Load cell type \*\*\*\_\*\*\*\_\*\*\*\_\*\*\*\***
- (4) Manufacturer: **Flintec GmbH**
- (5) Address: **Bemannsbruch 9, 74909 Meckesheim, Germany**
- (6) The design and construction of this equipment and any acceptable variation thereto are specified in the appendix to this supplement.
- (7) The certification body of DEKRA EXAM GmbH, notified body no. 0158 in accordance with Article 9 of the Directive 94/9/EC of the European Parliament and the Council of 23 March 1994, certifies that this equipment has been found to comply with the Essential Health and Safety Requirements relating to the design and construction of equipment and protective systems intended for use in potentially explosive atmospheres, given in Annex II to the Directive. The examination and test results are recorded in the test and assessment report BVS-PP 09.2098 EG.
- (8) The Essential Health and Safety Requirements are assured by compliance with:
  - IEC 60079-0:2011 General requirements
  - EN 60079-11:2012 Intrinsic safety 'I'
  - EN 60079-26:2007 Equipment Protection Level (EPL) Ga
- (9) If the sign "X" is placed after the certificate number, it indicates that the equipment is subject to special conditions for safe use specified in the appendix to this certificate.
- (10) This supplement to the EC-Type Examination Certificate relates only to the design, examination and tests of the specified equipment in accordance to Directive 94/9/EC. Further requirements of the Directive apply to the manufacturing process and supply of this equipment. These are not covered by this certificate.
- (11) The marking of the equipment shall include the following:

**II 1G Ex ia IIC T6/T5 Ga**      resp.      **II 2G Ex ia IIC T6/T5 Gb**  
**II 1D Ex ia IIIC IP67 T100°C Da**      **II 2D Ex ia IIIC IP67 T100°C Db**

DEKRA EXAM GmbH  
Bochum, dated 25.09.2012

Signed: Simanski

Signed: Dr. Eickhoff

\_\_\_\_\_  
Certification body

\_\_\_\_\_  
Special services unit

DEKRA

DEKRA



DEKRA

- (13) Appendix to
- (14) **1. Supplement to the EC-Type Examination Certificate  
BVS 09 ATEX E 086 X**

(15) 15.1 Subject and type  
Load cell type \*\*\*-\*\*\*-\*\*\*-\*\*\*\*

15.2 Description

The load cells have been assessed in acc. with IEC 60079-0:2011 and EN 60079-11:2012.

15.3 Parameters

Voltage	Ui	DC	30	V
Power	Pi		4	W
Ambient temperature range for Temperature Class T6 for Temperature Class T5 for Dust application	Ta			
				-40 °C up to +45 °C
				-40 °C up to +60 °C
				-40 °C up to +60 °C

- (16) Test and Assessment Report  
BVS PP 09.2098 EG as of 25.09.2012

- (17) Special conditions for safe use
  - 17.1 The load cells type PC22, PC42, PC46, PC60 and ZLB have an aluminium enclosure; if those cells are used in areas requiring Category 1G apparatus, avoid an ignition hazard due to impact or friction.
  - 17.2 The load cells type BK2, PC1, PC22, PC42, PC46, PC60, SB5, SLB, UB5, ULB and ZLB have a plastic surface larger than 4 cm<sup>2</sup>; if those cells are used in areas requiring Category 1G apparatus, avoid risk from electrostatic discharge.
  - 17.3 If the load cell is used in areas requiring Category 1G apparatus for gas group IIC, they should be installed in a way that intensive electrostatic charges are avoided.
  - 17.4 The load cells type \*\*\*-\*\*\*-\*\*\*-\*\*\*\*c have a coated cell body; if they are used in areas requiring Category 1D or 2D apparatus, avoid an ignition hazard due to propagating brush discharges.

We confirm the correctness of the translation from the German original.  
In the case of arbitration only the German wording shall be valid and binding.

DEKRA EXAM GmbH  
44809 Bochum, 25.09.2012  
BVS-Schu/Dj A 20121005

  
\_\_\_\_\_  
Certification body

  
\_\_\_\_\_  
Special services unit



(1) **Translation  
2<sup>nd</sup> Supplement to the  
EC-Type Examination Certificate**

- (2) Equipment and protective systems intended for use in potentially explosive atmospheres - Directive 94/9/EC Supplement accordant with Annex III number 6
- (3) No. of EC-Type Examination Certificate: **BVS 09 ATEX E 086 X**
- (4) Equipment: **Load cell type \*\*\*\_\*\*\*\_\*\*\*\_\*\*\*\***
- (5) Manufacturer: **Flintec GmbH**
- (6) Address: **Bemannsbruch 9, 74909 Meckesheim, Germany**
- (7) The design and construction of this equipment and any acceptable variation thereto are specified in the appendix to this supplement.
- (8) The certification body of DEKRA EXAM GmbH, notified body no. 0158 in accordance with Article 9 of the Directive 94/9/EC of the European Parliament and the Council of 23 March 1994, certifies that this equipment has been found to comply with the Essential Health and Safety Requirements relating to the design and construction of equipment and protective systems intended for use in potentially explosive atmospheres, given in Annex II to the Directive. The examination and test results are recorded in the Test and Assessment Report BVS PP 09.2098 EG.
- (9) The Essential Health and Safety Requirements are assured by compliance with:  
**EN 60079-0:2012 + A11:2013 General requirements**  
**EN 60079-11:2012 Intrinsic safety "i"**
- (10) If the sign "X" is placed after the certificate number, it indicates that the equipment is subject to special conditions for safe use specified in the appendix to this certificate.
- (11) This supplement to the EC-Type Examination Certificate relates only to the design, examination and tests of the specified equipment in accordance to Directive 94/9/EC. Further requirements of the Directive apply to the manufacturing process and supply of this equipment. These are not covered by this certificate.
- (12) The marking of the equipment shall include the following:

 **II 1G Ex ia IIC T6/T5 Ga    bzw.    II 2G Ex ia IIC T6/T5 Gb**  
**II 1D Ex ia IIIC T100°C Da    II 2D Ex ia IIIC T100°C Db**

DEKRA EXAM GmbH  
Bochum, dated 2015-11-06

Signed: Dr. Eickhoff

\_\_\_\_\_  
Certification body

Signed: Dr. Wittler

\_\_\_\_\_  
Special services unit



Page 1 of 3 of BVS 09 ATEX E 086 X / N2  
This certificate may only be reproduced in its entirety and without any change.

DEKRA EXAM GmbH, Dinnendahlstrasse 9, 44809 Bochum, Germany,  
telephone +49.234.3696-105, Fax +49.234.3696-110, zs-exam@dekra.com



- (13) Appendix to
- (14) **2<sup>nd</sup> Supplement to the EC-Type Examination Certificate BVS 09 ATEX E 086 X**

(15) 15.1 Subject and type  
Load cell type \*\*\*\_\*\*\*\_\*\*\*\_\*\*\*\*

15.2 Description

The load cells can be modified according to the descriptive documents as mentioned in the pertinent test and assessment report.

Two new types have been added:

Type PC7-\*\*\*\_\*\*\*\_\*\*\*\*

Type Q50-\*\*\*\_\*\*\*\_\*\*\*\*

15.3 Parameters

Voltage	Ui	DC	30	V
Power	Pi		4	W
Internal capacitance	Ci		0.16	nF/m
Internal inductance	Li		0.8	µH/m
Ambient temperature range for Temperature Class T6 for Temperature Class T5 for Dust application	Ta			-40 °C up to +45 °C -40 °C up to +60 °C -40 °C up to +60 °C

- (16) Test and Assessment Report  
BVS PP 09.2098 EG as of 2015-11-06

- (17) Special conditions for safe use
  - 17.1 The load cells type PC22, PC42, PC46, PC60 and ZLB have an aluminium enclosure; if they are used in areas, requiring Ga apparatus, avoid an ignition hazard due to impact or friction.
  - 17.2 The load cells type BK2, PC1, PC22, PC42, PC46, PC60, SB5, SLB, UB5, ULB and ZLB have a plastic surface larger than 4 cm<sup>2</sup>; if they are used in areas, requiring Ga apparatus, avoid risk from electrostatic discharge.
  - 17.3 For use of the load cells in areas, requiring Ga Group IIC resp. Da or Db Group IIIC apparatus, the connection cables must be installed in a way that a risk from electrostatic discharge is avoided.
  - 17.4 The load cells type \*\*\*\_\*\*\*\_\*\*\*\_\*\*\*\*c have a coated cell body; if they are used in areas, requiring Da or Db apparatus, avoid an ignition hazard due to propagating brush discharges.



Page 2 of 3 of BVS 09 ATEX E 086 X / N2  
This certificate may only be reproduced in its entirety and without any change.

DEKRA EXAM GmbH, Dinnendahlstrasse 9, 44809 Bochum, Germany,  
telephone +49.234.3696-105, Fax +49.234.3696-110, zs-exam@dekra.com