

TOTALCOMP TLI INDICATOR



Operation and Maintenance Manual

Manual

V1.08-0.06E
DT: 04/29/2013



 **Totalcomp**
Scales & Components
the weigh you want... *today!*

CONTENTS

Precautions.....	2
1. SPECIFICATIONS.....	3
2. INTRODUCTION.....	4
3. INSTALLATION.....	5
Unpacking.....	5
Parts Description.....	5
Initial Installation.....	6
Load Cell Connector.....	6
Connect Adapter and Charging.....	7
4. KEY DESCRIPTION.....	8
Keyboard.....	8
Secondary Functions of the Keys.....	8
Display.....	9
5. INITIAL SET UP.....	10
5.1 Power On/Off.....	10
5.2 Keyboard Lock/Unlock.....	10
5.3 Set auto power off.....	11
5.4 Set Back Light.....	12
6. PARAMETERS.....	13
7. CALIBRATION.....	17
7.1 Entering the Calibration Mode.....	17
7.2 Calibration.....	17
8. OPERATION.....	19
8.1 Basic Weighing.....	19
8.2 Check Weighing and Check Counting..	20
8.2.1. Setting Limits.....	20
8.2.2.1. Using Weight Limits Settings...	20
8.2.3 Checkweighing Using Pieces.....	21
8.2.4 Set Counting Beep Settings.....	22
8.3 Accumulation.....	23
8.3.1 Manual Accumulation Operation..	23
8.3.2 Auto Accumulation Operation.....	23
8.3.3 Memory Recall.....	24
8.3.4 Memory Clear.....	24
8.4 Part Counting.....	24
8.4.1 Parts Counting Operation.....	24
8.5 Animal Weighing.....	25
8.5.1 Animal Weighing Operation.....	25
9. RS-232 OUTPUT.....	26
10. MAINTENANCE.....	28
10.1 General.....	28
10.2 Error Codes.....	29

10.3 Determine the Problem.....	30
10.4 Check the Load Cell.....	30
10.5 Check Indicator Voltage.....	30
10.6 Problem and Solutions.....	31
11. TROUBLE SHOOTING.....	33
11.1 No Power.....	33
11.2 No Display.....	34
11.3 Battery not Charging.....	35
11.4 Not Weighing.....	36
11.5 Unstable.....	38
12. AVAILABLE OPTIONS.....	37
13. ANALOG OUTPUT INSTALLATION.....	38
14. CONNECTING TO LIGHT TOWER.....	39

PRECAUTIONS

	 WARNING
	DISCONNECT ALL POWER TO THIS UNIT BEFORE INSTALLING, CLEANING, OR SERVICING. FAILURE TO DO SO COULD RESULT IN BODILY HARM OR DAMAGE THE UNIT.

 CAUTION
<ul style="list-style-type: none">• Permit only qualified persons to service the instrument• Before connecting or disconnecting any components, remove the power.• Failure to observe these precautions may result in bodily harm, damage to or destruction of the equipment.



- The TLI Indicator is a precision electronic instrument, handle it carefully.
- Do not install the scale in direct sunlight.
- Verify the local voltage and receptacle type are correct for the TLI Indicator.
- Only use the original AC adapter, any other could cause damage to the TLI Indicator.
- Only plug the TLI Indicator into properly wire wall outlet. Avoid plugging in the AC Adapter to an extension cord.
- Avoid unstable power sources. Do not use near large users of electricity such as welding equipment or large motors.
- Avoid sudden temperature changes, vibration, wind and water.
- Avoid heavy RF noise.
- Keep the indicator clean

1. SPECIFICATIONS

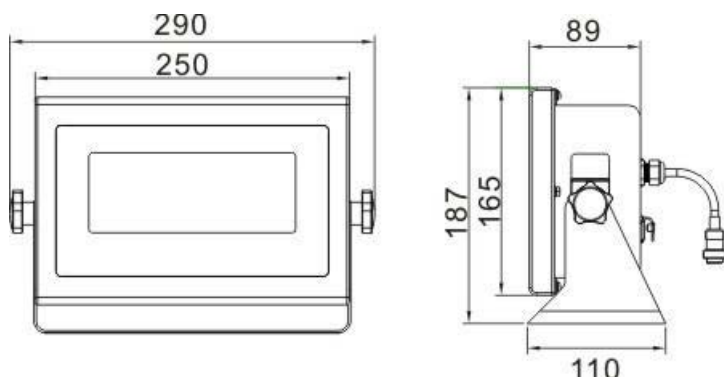

Model	TLI
Display	2 inch LCD
Housing	Stainless Steel
Operating Temperature	-10°C - 40°C / 14°F - 104°F
Resolution	1/6000
Key Pad	7 Keys
Power	AC Adapter (12V/500mA)/ Battery (6V/4Ah)
Calibration	Automatic External
Interface	RS-232 Output (installed), Relay output w/light tower and 4-20ma output are optional
Excitation Voltage	Max: 5V/150mA
Load Cells	Up to (4) 350 ohm load cell
ADC	Sigma Delta
ADC Update	≤1/10 second
Stabilization Time	One second typical
IP rate	IP65 (protected against low pressure jets of water)

2. INTRODUCTION

- The TLI Indicator is a weighing instrument that amplifies analog signals from a load cell(s), converts it to digital data, and displays it as a mass value.
- The TLI Indicator is suitable for general weighing or more specialized applications such as check weighing, animal weighing, piece counting and accumulation applications.
- The TLI Indicator can connect directly to a number of printers or a PC via the standard RS-232 port.
- The TLI Indicator has a large LCD display (2") with a white LED backlight.
- The TLI Indicator has a number of options such as:
 - Relay Output with a Light Tower
 - 4-20ma Output
 - 0-10VDC output

3. INSTALLATION

Unpacking

When you receive the TLI Indicator, inspect it to make sure that it has not been damaged during shipping. Please contact the carrier to file a claim for any damage during shipping.

- Remove the TLI Indicator from the carton.
- Remove the protective covering. Store the packaging to use if you need to transport the TLI Indicator at a later date.
- Make sure all components are included.
 1. TLI Indicator
 2. AC Adapter
 3. This Manual
 4. Wall/Table Mount Frame
 5. RS-232 & Load Cell connectors (in clear bag)

Parts Included:



Initial Installation

- Place the TLI Indicator on a table or mount to a wall using the Table/Wall Frame.
- Plug the AC adapter pin into the TLI Indicator adapter jack on back of unit.
- Plug AC Adapter into an easily accessible wall outlet with a protective earth/ground contact.
- Avoid using extension cords for the AC Adapter.

Load Cell Connector

- Use the enclosed 5-Pin connector for the Load Cells
- Solder your platform cable to the connector as shown below.

Pin	Connection
Pin 1	Signal +
Pin 2	Signal -
Pin 3	Shield
Pin 4	Excitation -
Pin 5	Excitation +

- The TLI Indicator can handle up to four 350 ohm load cells.
- The load cell excitation voltage is 5V DC $\pm 5\%$ between Excitation + and Excitation -.

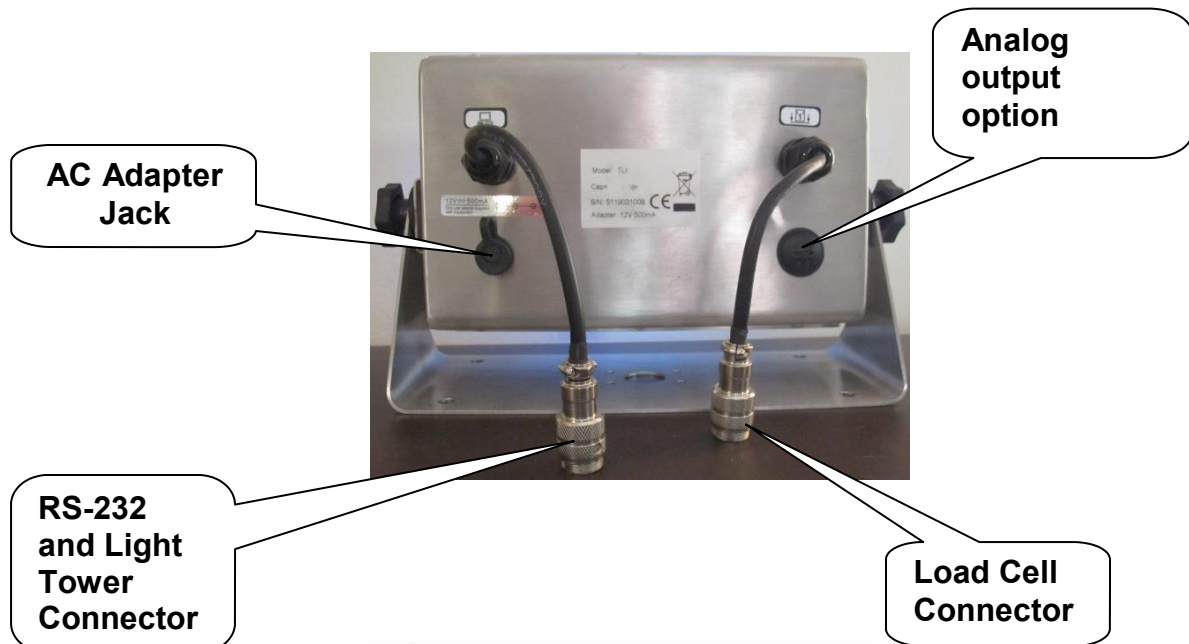

Connect Adapter and Charging







Note: Please charge the battery before using the scale for the first time.

- To charge the internal battery, insert the AC adapter pin to the jack on the back of the unit (See picture on previous page). AC Adapter plugs into a standard wall outlet. The scale does not need to be turned on to charge the battery. The CHARGE led on the front of the TLI Indicator will turn red while the AC Adapter is providing power to the TLI Indicator.
- The battery should be charged for a minimum of 12 hours for full capacity.
- While plugged into the AC adapter, there is an LED to indicate the status of battery charge. If the CHARGE LED is green, the battery has a full charge. If it is red, the battery is nearly discharged and if yellow, the battery is being charged.
- Do not use any other type of AC Adapter other than the one supplied with the TLI Indicator.
- Verify that the incoming AC power is properly protected.





4. KEYS DESCRIPTION





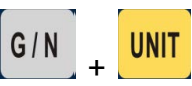

Keyboard

Keys	Description
	Power ON/OFF
	Set the zero point when the scale is empty
	Tare function, subtracts empty container weight.
	Memory recall key, displays the stored values from the memory location.
	Accumulator key, current values will be stored to memory. Send the data to a printer or PC
	To select the weigh unit. (Kg, g, lb., oz., lb. oz.)
	Display Gross or Net Weight.

Double Key Functions

	Enter to set the high and low limits.
	Clear the memory.
	To enter or exit animal weighing mode.

Secondary Functions of the Keys

Function	Keys
Used to select a menu item and/or load a value into memory	
Used to scroll through menu items and change the value of an active (flashing) digit	
Used to move the active digit to right	
Used to move the active digit to left	
Used to enter in to the Parameters (during power-up sequence only)	
Used to move up one level in the Parameters or return to normal operation.	

Display

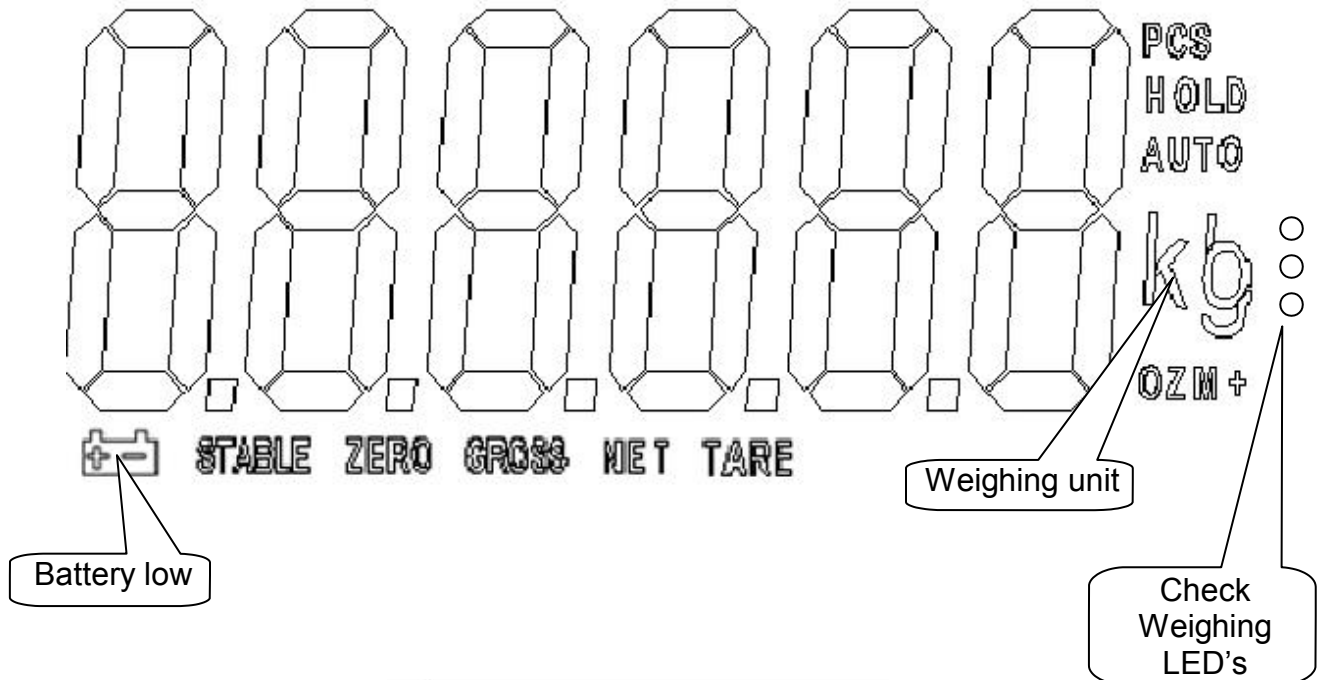

5. INITIAL SET UP

Initial Start-up



5.1 Power On/Off

Turn on the TLI Indicator by pressing **ON/OFF** key once. The TLI Indicator turns on and starts a self-test before displaying a normal display.

NOTE: A warm-up time of 15 minutes allows the TLI Indicator to stabilize the internal temperature of the TLI Indicator. This is only needed after a period of more than 1-day of being off.

5.2 Keyboard Lock/Unlock







If activated, and the keys are not using within 10 minutes, the keyboard will be locked automatically. Once in the locked mode, pressing any key the display will show $\bar{t}-\bar{L}at$ for a few seconds. Then the TLI Indicator will return to a normal display.

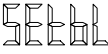

To unlock the TLI Indicator keyboard press and hold  ,  and  keys for three seconds. The TLI Indicator display will show $\bar{u}\bar{n}\bar{L}at$ for a few seconds. The TLI Indicator display will return to a normal display and the keyboard will be active.

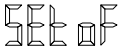
To activate the Keyboard Lock feature, review parameter P4 in Section 6 of this manual.

5.3 Set auto power off



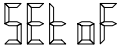

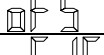
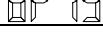

The TLI Indicator can be set to power off after a period of non-use extending its battery life between re-charging.



- Hold  three seconds display will show 
- Press  to select 
- Press  to confirm
- Press  to change the options.
- Press  to confirm the option selected
- Press  to exit this option

		Set TLI Indicator to always on
		Set TLI Indicator to turn off after 5 minutes of non-use
		Set TLI Indicator to turn off after 15 minutes of non-use

5.4 Set Back Light



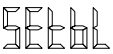
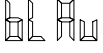
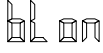



The TLI Indicator can set back light to one of three options.

- Hold  three seconds display will show 
- Press  to confirm
- Press  to change the options.
- Press  to confirm the option selected
- Press  to exit this option

		Auto option: Backlight will turn on and off based on usage.
		Always on: Backlight will remain on.
		Always off: Backlight will remain off.

6. PARAMETERS

To enter the parameter menu follow the following.

- Power on the TLI Indicator.
- Press  key anytime during the start-up display test.
- Display will show 
- Press  then  then  one at a time. The display will show a  for each key pressed.
- If correct keys were pressed in sequence, the display will show . If a wrong key was pressed, the TLI Indicator will continue to its normal display.

Navigation within the Parameters of the TLI Indicator is accomplished by using the following keys:



Used to scroll through the main and sub menus, options, and change the value of a selected digit



Used to enter a selected main or sub menu, select an options or value



Used to select a digit to the left or right of the current position







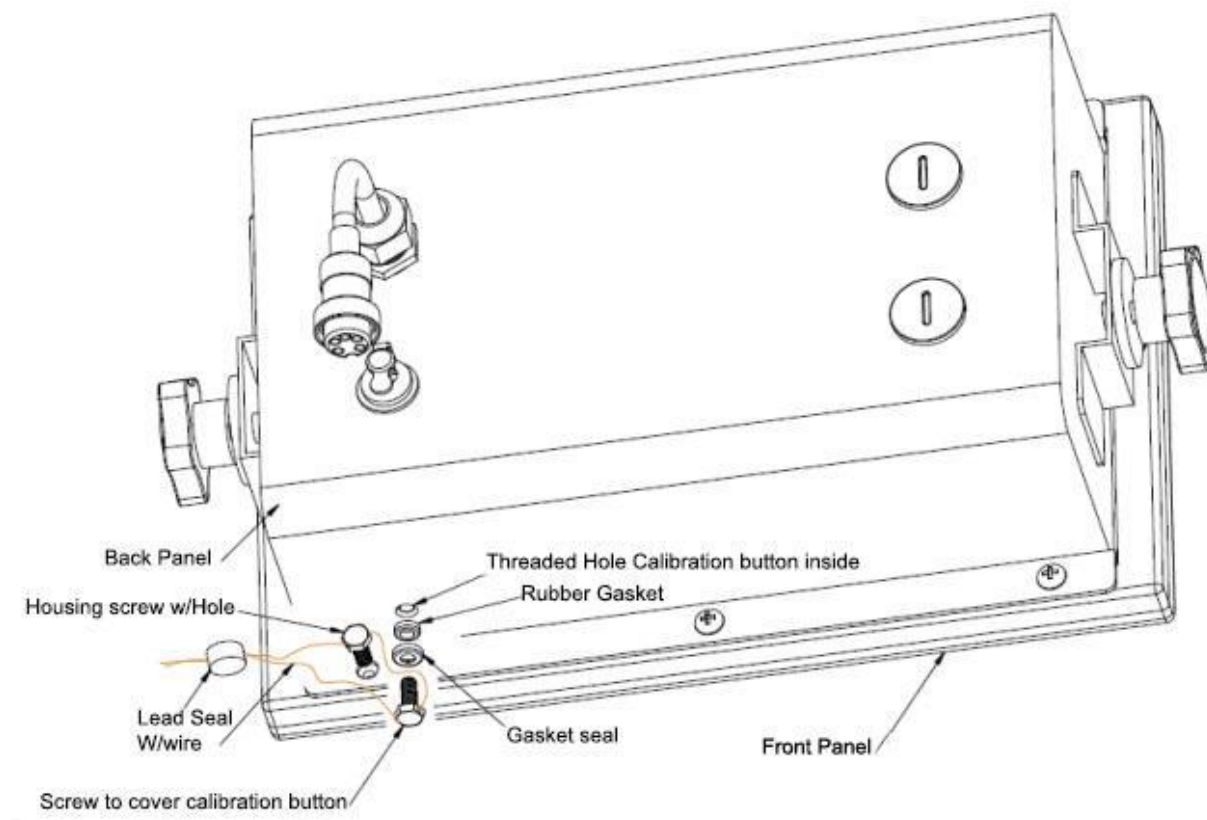

Used to back one level in the Parameter menu

Note:

Access P3 Mode Parameters for (Div./Cap./Calibration):

Press CAL switch (momentary push button) for to access P3 mode parameters, CAL switch is located at the bottom of rear cover (see picture). Push button located inside the case use small screw driver or pin to push momentary button.

















Menu	Sub Menu	Description		
P0 Check Weight POCHT	HGH HLL	Set high limit for check weighing		
	HLL HLL	Set low limit for check weighing		
	BEEP NO	No beep for check weighing		
	BEEP OF	Beep, when check weighing between the limits		
	BEEP OF	Beep, when check weighing out of the limits		
P1 Communication P1C0ñ	C0ñE Prt	RS232C RS232C	Sends continuous data via the RS-232 port	
		RS232C RS232C	Sends stable data once via the RS-232 port	
		RS232C RS232C	Send continuous stable data via the RS-232 port	
		To select manual accumulation by pressing  key and Printer options for printouts.		
		DLP-50 LP50		There are four formats (see section 8.3) (LP50: DLP-50 Label Printer)
		STP103 SRP103		There are four formats (see section 8.3) (STP103/SRP275: Epson Format)
		SRP275 SRP275		There are four formats (see section 8.3) (STP103/SRP275: Epson Format)
		SRP770 SRP770		There are four formats (see section 8.3) (SRP770:)
		TPuP TPuP		Select TPuP printer. (TYJ-360-D roll paper printer)
		Auto		To set auto accumulation and auto printing

		RS	To send command to the TLI Indicator via the RS-232 port. Command R: read data Command T: Tare Command Z: Zero
		SE, rE	To send continuous data to a remote display. (TSR/Aurora/LaserLight)
		baud	Sets the baud rate. Available baud rates are: 600 1200 2400 4800 9600
		P _r	Set the parity: (7 even 1; 7 odd 1; 8 none 1) 7E1 7o1 8n1
P2 Swt P2Sw		Prt	Prints without accumulation (Clears the accumulation value)
		Acc	Accumulation without printing
		both	Prints and accumulates
P3 Mode P3Mod		Count	Displays internal raw counts
		dec.	To set decimal point location options are: 0 00 000 0000 00000
		dw	To set display increment options are: 1 2 5 10 20 50
		FS	Set Full Scale Capacity of the Scale Platform
		CA	Run Scale Calibration
		GRA	To set local geographical gravity (future)
P4 Other P4oth		Lock	To set keyboard lock options are: on off
		Anim	To set animal mode options are: on off
P5 Unit P5unit		Kg / g / oz. / lb. oz.	To enable/disable each weighing unit options are: on off (Primary unit is lb.)
P6 Ref P6 ref		Azn 0	Automatic zero tracking Options: 0d / 0.5d / 1 d / 2 d / 4 d
		0auto	Zero setting range, after switching on the scale to zero. Options: 0% , 2% , 5% ,10% , 20%
		0range	Manually zero setting range. Options: 2% , 4% ,10% , 20% , 50% , 100%



7. CALIBRATION

Note: To enter into the calibration mode operations, refer section 6. Page 14 for to enter and access.



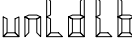
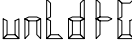

7.1 Entering the Calibration Mode:

- Power on the TLI Indicator.
- Press the  key anytime during the start-up display test.
- Display will show 
- Press the  then the  then the  one at a time. The display will show a  for each key pressed.
- If correct keys were pressed in sequence, the display will show . If a wrong key was pressed, the TLI Indicator will continue to its normal display.
- Press the  key until the display shows .
- Press the  key to confirm, the display will show .
- Press the  key to select option .
- Press the  key to confirm and start calibration.

7.2 Calibration:

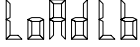
- If the current unit is weighing in pounds, the display will show 
- If the current unit is weighing in kilograms, the display will show 
- Remove all the weight from the platform.
- When indicator displays the word STABLE in the lower left of the display, press the  key to confirm.
- Display will show the last calibration weight.
- If want to change the calibration weight value, use the keys to select the desired digit.
- Press the  key to increment the value.



- When the calibration weight value is correct, press the  key to confirm.
- If the current unit is weighing in pounds, the display will show 
- If the current unit is weighing in kilograms, the display will show 
- Place the calibration weight on the platform.
- When indicator displays the word STABLE in the lower left of the display, press the  key to confirm.
- If the calibration was successful, the TLI Indicator will display 
- Display will return to a normal weighing mode.
- Remove the calibration weight from the platform.
- The display will show 0 weight.

8. OPERATION

8.1. Basic Weighing:

Definitions:

Gross Weight: Total load applied to a scale platform

Tare Weight: The weight of an empty container

Net Weight: The weight of the material inside an empty container
(Net Weight = Gross Weight – Tare Weight)

Zero



Environmental conditions can lead to the TLI Indicator to drift off of a 0 value despite not having any load applied to the platform. To compensate

for this press the  key to return the display to a value of 0.

Tare

The weight of any container can be stored as tare weight by pressing the  key. If the indicator connected to a Via RS-232, Computer you can send digital Tare example “net 110lb” make sure you have a space between the “net and the weight value. Also you can Key in the Tare value using the front keypad example press the Tare key for more than 3 seconds the indicator will beep and showing a flashing digit using the arrow keys enter the Tare value, than press Enter key, now the display will show actual weight on the platform without the entered Tare weight.

Follow this procedure for using the Tare function.

1. Place an empty container on the platform.
2. Press the  key. 0 is displayed, and tare is stored and subtracted from the gross weight.
3. Place items in the empty container.
4. The TLI Indicator display will show the net weight of the material only.
5. Remove the container. The tare weight is displayed as a negative value. Only one Tare can be stored at a time.
6. Press the  key to change between gross weight and net weight.
7. To clear the tare value, remove the container and press the  key. 0 is displayed and the tare weight is cleared.



3. Select Unit

Press the  key, to change the display to read the weight in another unit of measure. The options are: kg / g / lb. / oz. / lb. oz. if they are enabled. Refer to Parameter P5 in Section 6 of this manual to enable and/or disable these units of measure.

8.2 Check Weighing and Check Counting







The TLI Indicator can perform Checkweighing or Check Counting by setting upper and lower limits to get a HI, LO, or OK led indication. A pulsing beep is also available as an audible for Checkweighing and Check Counting .

8.2.1. Setting Limits





- Press  and  key together, display will be show `netH` .
- Press  key to select, `netH`, `netL`, `PCSH`, `PCSL`, and `BEEP` .

8.2.2 For Checkweighing Using Weight Limits Settings:

8.2.2.1 When the display shows `netH`:







- Press  key to confirm, display will show all zeroes in the decimal format selected and start to blink the least significant digit.
- Enter the high limit weight value by using the   keys to select the desired digit to change
- Press the  key to increment the weight value of the selected digit.
- Press the  key when the desired weight value is displayed for the high limit value.
- Display will show `netH`.
- Press  key to select `netL` .

8.2.2.2 When the display shows **net L**:







- Press  key to confirm, display will show all zeroes in the decimal format selected and start to blink the least significant digit.
- Enter the low limit weight value by using the  keys to select the desired digit to change
- Press the  key to increment the weight value of the selected digit.
- Press the  key when the desired weight value is displayed for the low limit weight value.
- Display will show **net L**.
- To escape from the settings menu and start the checkweighing procedure using weigh limits, press the  key.

8.2.3 For Checkweighing Using Pieces Settings:





8.2.3.1 When the display shows **net H**:

- Press  key to select, **PESH**.
- Press  key to confirm, display will show all zeroes and start to blink the least significant digit.
- Enter the high limit pieces value by using the  keys to select the desired digit to change
- Press the  key to increment the pieces value of the selected digit.
- Press the  key when the desired pieces value is displayed for the high limit pieces value.
- Display will show **PESH**.
- Press  key to select **PESL**.

8.2.3.2 When the display shows **PESEL**:

- Press  key to confirm, display will show all zeroes and start to blink the least significant digit.
- Enter the low limit pieces value by using the   keys to select the desired digit to change
- Press the  key to increment the pieces value of the selected digit.
- Press the  key when the desired pieces value is displayed for the low limit pieces value.
- Display will show **PESEL**.
- To escape from the settings menu and start the checkweighing procedure in the pieces limits, press the  key.

8.2.4. Set Check Weighing and Check Counting beep settings

- Press  and  key together, display will be show **NETH**.
- Press  key to select display **BEEP**.
- Press  key to confirm, display will show last desired setting. It will be either **no**, **ot**, or **ni**
- **Check mode no** : No pulsing beep sound. Function turned off.
- **Check mode ot** : When the weight is between the limits. The OK led will illuminate and a pulsing beep will be sounded continuously.
- **Check mode ni** : When the weight is out of limits, a pulsing beep will be sounded continuously. The LO or HI led will be illuminated.



Note: Check weighing and check counting available only when weight exceeds 20d

8.3. Accumulation

The TLI Indicator can be set to accumulate manually by pressing the  key. Refer to Parameters P1 and P2 in Section 6 of this manual for accumulation and printout options.

Before operation TLI Indicator should be stable and showing a zero value. Accumulation will begin after an applied weight of more than 20d.

8.3.1 Manual Accumulation Operation:

- Place the load on the platform.
- Press the  key, when displayed weight is stable.
- The display will show  for 3 seconds then show the total weight of all accumulated values also for 3 seconds.
- Remove the weight from the platform.
- When display returns to a zero value and is stable, repeat the procedure for the second, third, etc. up to 99 different weight accumulations.

8.3.2 Automatic Accumulation Operation:

The TLI Indicator can be set to accumulate automatically. Refer to Parameters P1 in Section 6 of this manual for auto accumulation.

- Place the load on the platform.
- When the weight is stable, the display will show  for 3 seconds then show the total weight of all accumulated values also for 3 seconds.
- Remove the weight from the platform.
- When display returns to a zero value and is stable, repeat the procedure for the second, third, etc. up to 99 different weight accumulations.

8.3.3 Memory Recall:

To recall the accumulated memory press the  key.



Display will show  (n: Total number of accumulations recorded) for 3 seconds then the display will show the total saved weight value for 3 seconds.

8.3.4 Memory Clear:





To clear the memory, press the  and the  keys together.

Display will show . All accumulation memory has been cleared.

8.4. Parts Counting

To enter the parts counting, press and hold the  key. The display will show .



8.4.1 Parts Counting Operation

- Press the  to select the correct amount of parts that will be put on the scale to calculate the piece weight. The parts quantity options are:

- Place the correct amount of parts on the platform
- Press the  key to confirm, display will show ---- until a stable weight is detected show a piece weight can be calculated.
- The TLI Indicator will show the quantity of pieces put on the platform.
- You can now add more parts to the platform, the TLI Indicator will update the display to show the new quantity on the platform.
- Press the  key to exit the piece counting mode and return the TLI Indicator back to normal weighing mode.

8.5 Animal Weighing

The TLI Indicator can be used for loads that will cause excessive vibration on the platform such as animal weighing. Refer to Parameters P4 in Section 6 of this manual to setup the Animal Weighing mode. When in the Animal Weighing mode, the display will show “HOLD” in the upper right corner.

8.5.1 Animal Weighing Operation

- Put the noisy load on the platform
- The TLI Indicator will perform a slower averaging of the weight to get a more stable reading.
- When the TLI Indicator calculates a weight, the display will show the locked value for a few seconds.
- You can add or remove loads. The TLI Indicator will update the weight and display it once it recalculates the new value.
- To enter or exit animal weighing mode, press the  and  keys simultaneously.

9. RS-232 OUTPUT

The TLI Indicator comes standard with an RS-232 output.

9.1. Basic Specifications:

- RS-232 output of weight data
- ASCII code
- 7/8 data bits
- Parity selectable
- Baud rate from 600bps to 9600bps

- Connector: 9 pin socket
- Pin 2: Serial Input
 - Pin 3: Serial Output
 - Pin 5: Signal Ground

- Check weighing output (9 pin socket)
- Pin 1 VB
 - Pin 4 vcc (5V)(output)
 - Pin 5 com (gnd) public
 - Pin 6 ok (output)
 - Pin 7 low (output)
 - Pin 8 hi (output)
 - Pin 9 beep (output)

9.1.1 Continuously Serial Output Protocol

Parameter 1 Section 6 of this Manual: *Cont*

		,		- / \square								g l	g b	CR	LF
-HEADER1--			- HEADER2-		--- WEIGHT DATA ---						UNITS				

HEADER1: ST=STABLE , US=UNSTABLE

HEADER2: NT=NET , GS=GROSS

8.3 Printing formats: Parameter 1 Section 6 of this Manual: 



LP-50: (DLP-50 Label Printer)	
Pr 0	2000/00/00 00:00 No. xx NET xxx kg TARE xxx kg GROSS xxx kg
Pr 1	NET xxx kg TARE xxx kg GROSS xxx kg
Pr 2	GROSS xxx kg Total xxx kg
Pr 3	NET xxx kg TARE xxx kg GROSS xxx kg Total xxx kg

STP103 / SRP275: Epson format	
Pr 0	Net xxx kg Tare xxx kg Gross xxx kg
Pr 1	Gross xxx kg Total xxx kg
Pr 2	Net xxx kg Tare xxx kg Gross xxx kg Total xxx kg
Pr 3	No. xx Net xxx kg Tare xxx kg Gross xxx kg Total xxx kg

SRP770:	
Pr 0	No. xx NET xxx kg TARE xxx kg GROSS xxx kg
Pr 1	NET xxx kg TARE xxx kg GROSS xxx kg
Pr 2	GROSS xxx kg Total xxx kg
Pr 3	NET xxx kg TARE xxx kg GROSS xxx kg Total xxx kg

TPuP: (TYJ-360-D printer)	
No. xx	
Net xxx kg	

10. MAINTENANCE

	 WARNING
	DISCONNECT ALL POWER TO THIS UNIT BEFORE INSTALLING, CLEANING, OR SERVICING. FAILURE TO DO SO COULD RESULT IN BODILY HARM OR DAMAGE THE UNIT.

 CAUTION
<ul style="list-style-type: none">• Permit only qualified persons to service the instrument• Before connecting or disconnecting any components, remove the power.• Failure to observe these precautions bodily harm or damage to or destruction of the equipment.

10.1 General

If the TLI Indicator does not operate properly, troubleshoot the problem if possible or contact Totalcomp for assistance in troubleshooting.

Determine whether the problem is constant or intermittent. Be aware that problems can be caused by mechanical or electrical influences.

Check the area for the following possible problems.

- Water
- Corrosive materials
- Vibrations or temperature or wind
- Physical damage

Check the TLI Indicator's cables for physical damage.
 Check all connections and connectors for any loose contact or incorrect wiring.

10.2 Error Codes

The TLI Indicator may display one of the following error messages to assist in troubleshooting a problem.

Error Message	Description	Solution
◊ ◊ ◊ ◊ ◊	Maximum load exceeded	Unload or reduce weight
Err 4	Zero setting error	Zero setting range exceeded due to switching on.(4%max) Make sure platform empty.
ERR 5	Keyboard error	Check the keys and connector.
Err 6	A/D value out of range	Make sure platform is empty and installed properly. Check the load cell connections.
Err 9	Unstable Reading	Check any air flow, building vibration, RF noise or mechanical touching on the platform. Check the load cell and connections.
Err 17	Tare out of range	Remove the load and restart scale again.
--OL--	Over range	Remove the load and re-calibrate
FAUL / FAUL	Calibration Error	Re-calibrate
Err P	Printer error	Check the printer and settings
baLa / LaBa	Battery low	Re-charge battery, check the voltages.

10.3 Determine the Problem

Determine whether the problem is in the TLI Indicator or the scale platform

- Remove power from the system, and disconnect the indicator from the platform
- Connect the indicator to a load cell simulator
- Turn on power to the TLI Indicator and test the TLI Indicator using the load cell simulator.
- If problem goes away, its source is probably in the platform. Check the load wiring, connector, load cells and mechanical components of the platform.
- If problem persists, its source is probably in the indicator. Check the indicator voltages, connectors, cables and function programs.

10.4 Check the Load cell

- Remove power from the system, and disconnect the TLI Indicator from the platform
- Remove the load connector from platform terminal.
- Check for moisture, or foreign material inside.
- Make sure all leads are connected and soldered correctly. See the details of connections in the Installation section.
- Check load cell for proper input and output resistances

Measuring Points	Resistance
+ Exc to –Exc (Input)	Minimum 350 ohms
+Sig to –Sig (Output)	347 ~ 353 ohms One Cell
+Sig to –Sig (Output)	172 ~ 178 ohms Two Cells
+Sig to –Sig (Output)	113 ~ 119 ohms Three Cells
+Sig to –Sig (Output)	84 ~ 90 ohms Four Cells

10.5 Check Indicator Voltages

If the problem is in the Indicator, use a DVM to check the following voltages

10.5.1 AC Power

Check the AC power at the wall outlet or supply voltage.

- Voltage must be a -20% and +10% of the normal AC voltage.

10.5.2 Adaptor Voltage

Check the adaptor output cable connector voltage

- Voltage must be minimum 9VDC and maximum 15VDC

10.5.3 PCB Input Voltage

Check the PCB input power connector voltage

- Voltage must be minimum 9VDC into the pin AD+

10.5.4 Check Battery Voltage and Charging Voltage

Check the Battery Voltage,

- Voltage must be minimum 6VDC. If below the 6VDC connect the adaptor for charging
- The battery voltage below the 5.5VDC, replace the battery and install new 6V/4Ah battery.

Check the Battery Charging Voltage;

- Remove the battery connection terminals (Red and Black) from the battery.
- Connect the power and turn on the Indicator
- Voltage into the terminal minimum 6.5VDC

10.6 Problems and Solutions

Problems	Possible cause	Common Solutions
Display is blank. No self-test	Mains power is turned off. Power supply faulty or not plugged. Internal battery is not charged. On/Off switch problem	Check power is getting inside the TLI Indicator and on/off switch is working. Verify the voltages, which are on the power supply label.
Blank display after self-test	Platform not installed. Unstable weight, load cell damaged	Check the platform is installed correctly. Try recycling the power on the TLI Indicator.
OL or -----	Maximum capacity exceeded. Load cell or mechanics damaged. Power supply faulty	Check the platform is installed correctly. Try recycling the power on the TLI Indicator. Repeat the calibration procedure.

----- or NULL displayed	Weight is on the platform is below permissible limit. Pan not installed correctly. Power supply faulty. Load cell or mechanism faulty	Check the platform is installed correctly. Try to turn on the scale again. Do the calibration again
Display is unstable	Goods touching somewhere. Air variation or any vibrations. Temperature changed. Load cell or connections faulty. Power supply faulty	Check the scale is in acceptable location. Check the connectors and load cell. Check the power supply and battery
Weight value incorrect	Calibration error. Platform of load cell touching somewhere. Wrong weighing unit	Use accurate weight for to do the calibration Check the pan and load cell is installed proper and touching. Check the parameter settings. Check the load cell and connectors
Cannot use full capacity	Over load protection stoppers or transport locks are not removed. Parameters are set incorrectly. AD problem. Load cell or mechanism damaged	Check the stoppers and locks under the platform. Check the weighing unit and parameter settings. Check the load cell.
Platform Corner Weight different	Over load protection stoppers or transport locks are not removed. Load cell or mechanism damaged	Check the stoppers and locks under the platform. Use accurate weight for to do the calibration Check the load cell.
Battery not charging	Mains voltage problem Charging circuit problem Battery Problem	Check the mains and adaptor. Check the battery. Check the charging circuit

11. TROUBLE SHOOTING

11.1 No Power

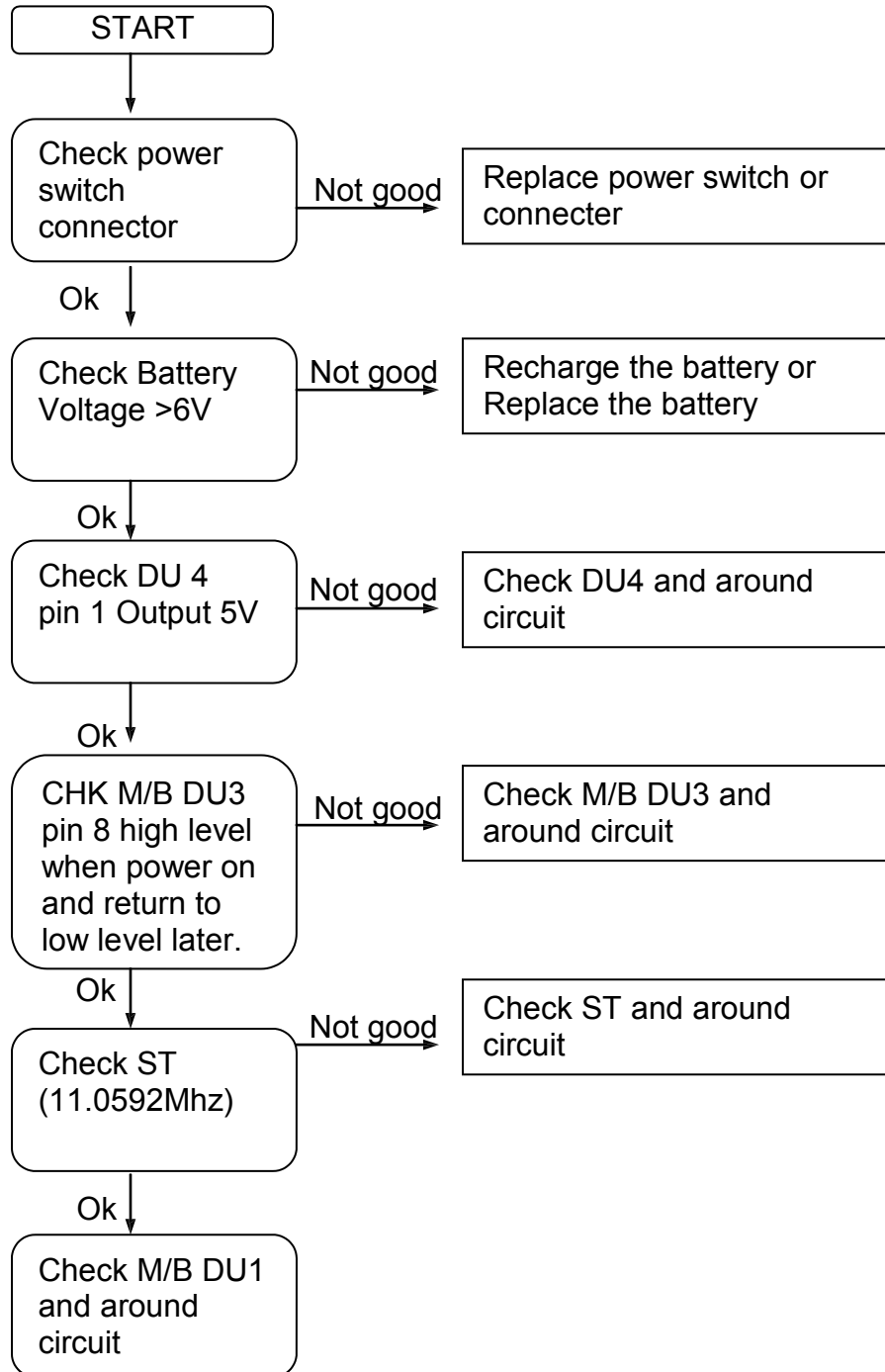

11.2 No Display

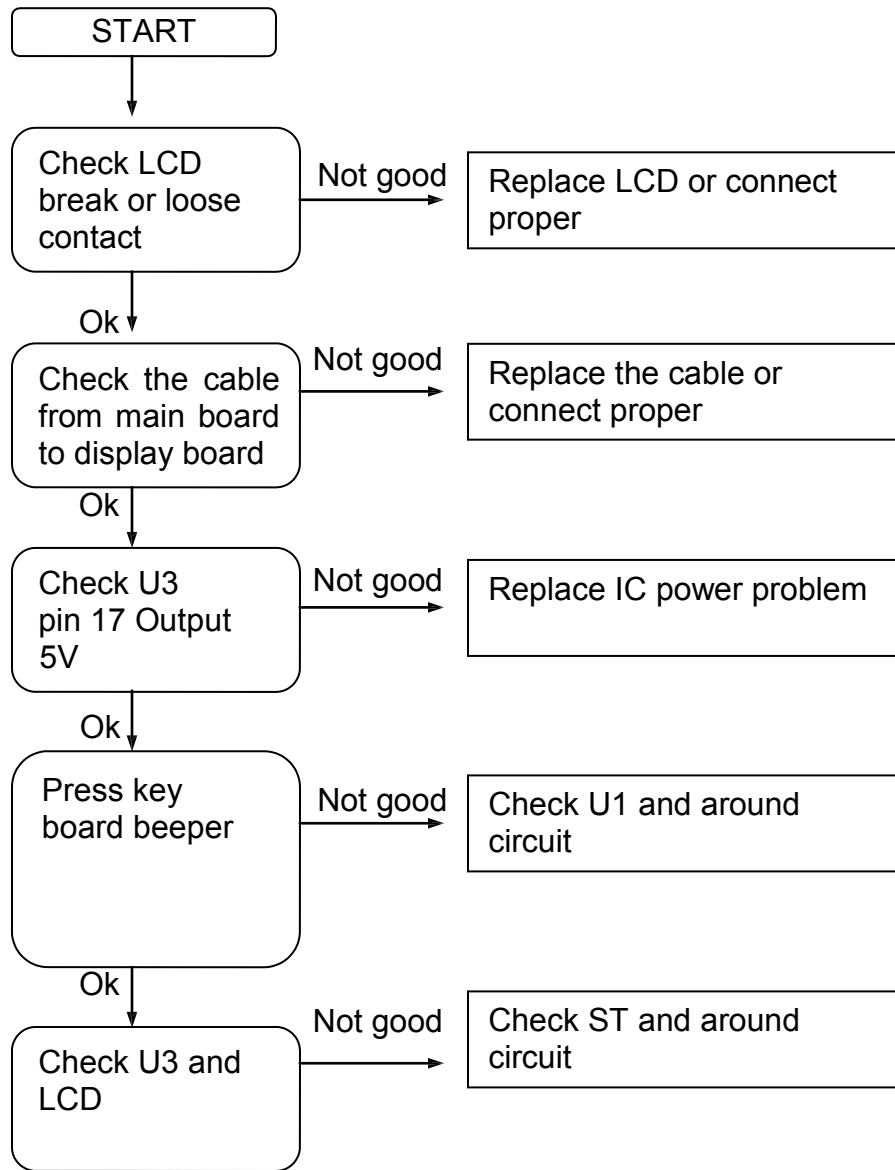

11.3 Battery not charging

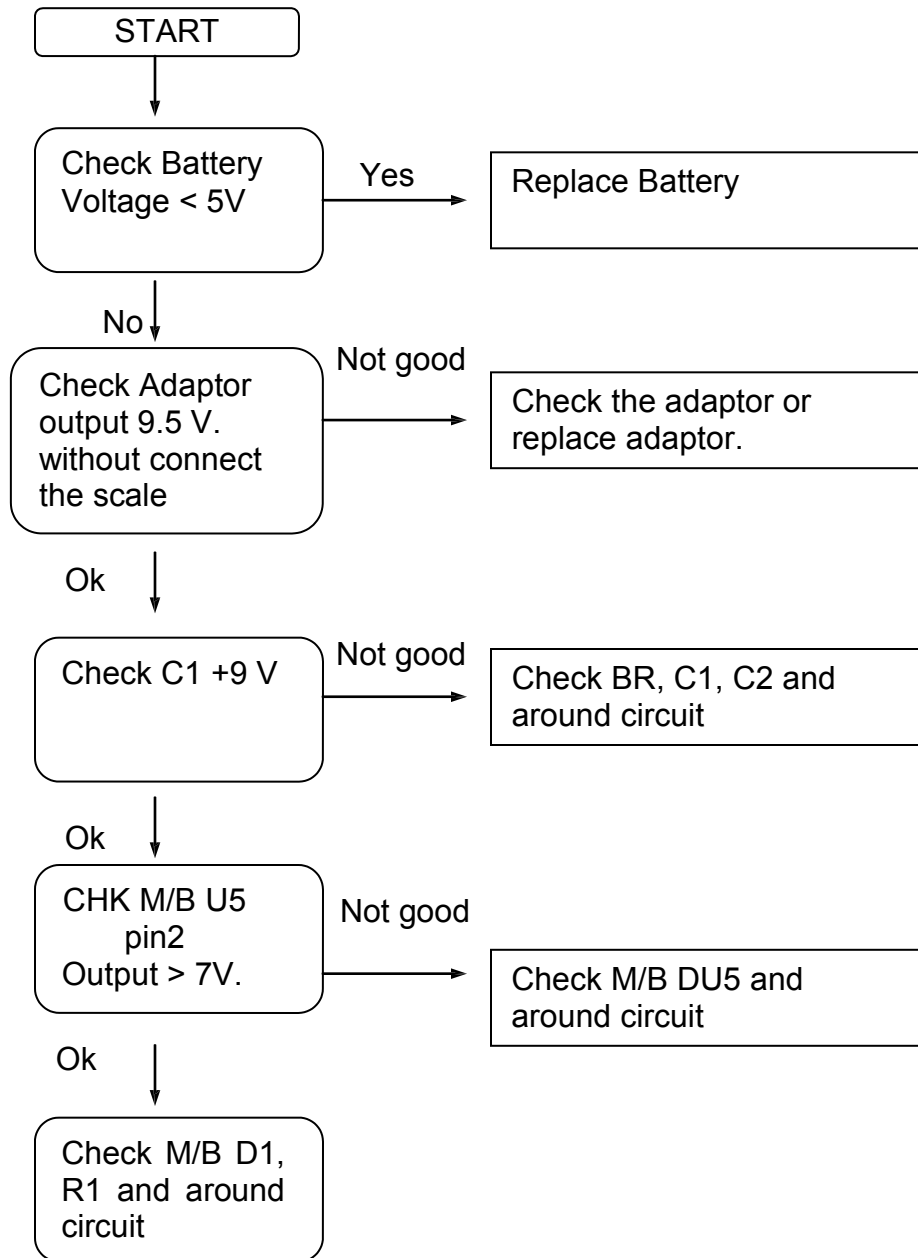

11.4 Not Weighing

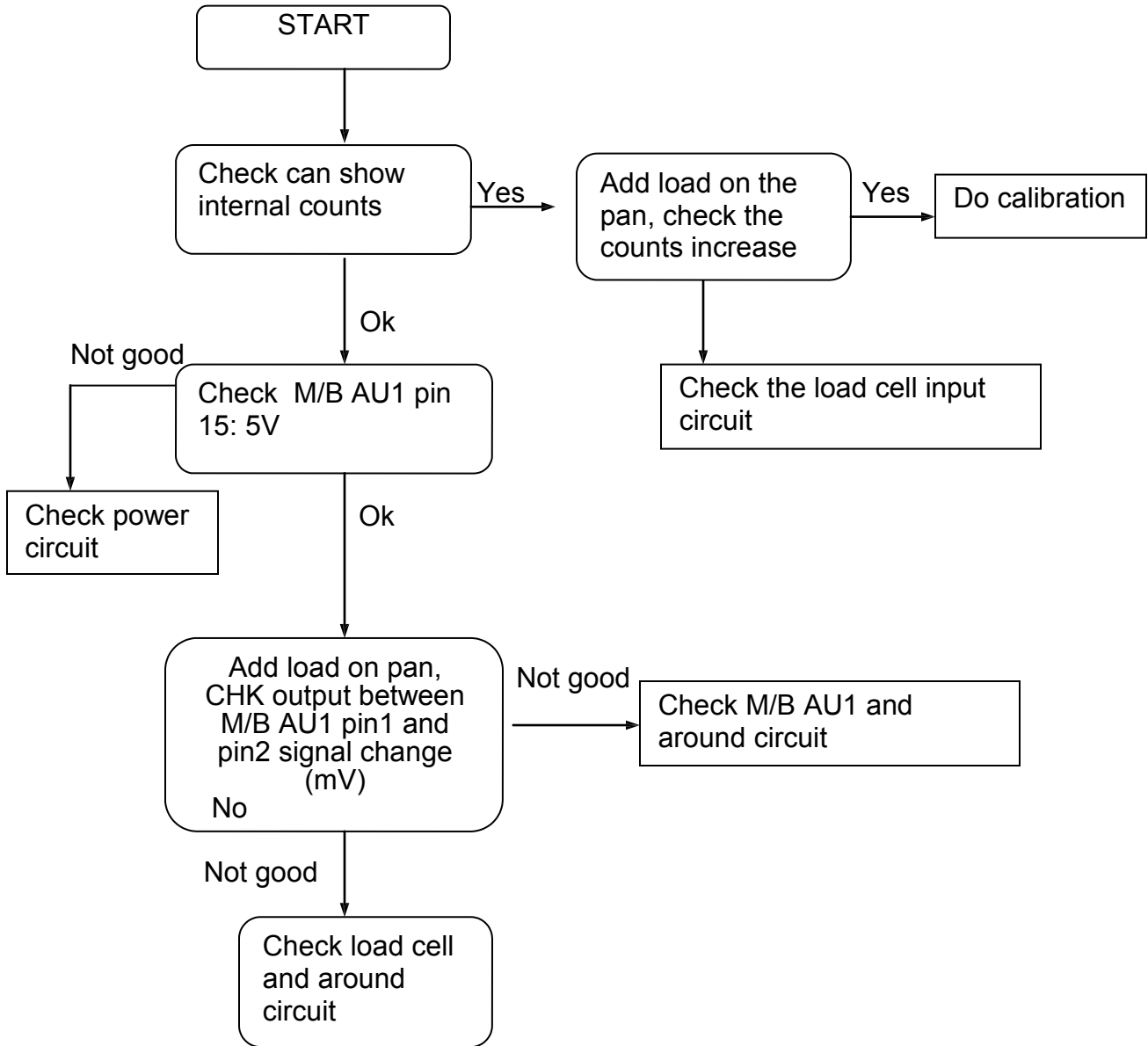

11.5 Unstable

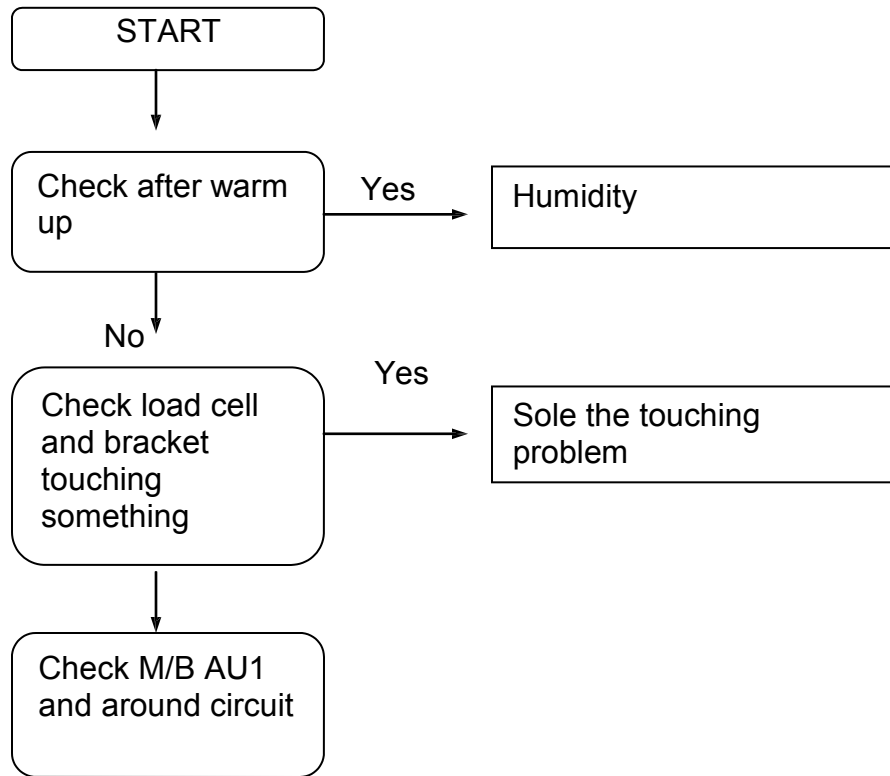

12. AVAILABLE OPTIONS

- AL-01E LED color changing light tower
- TYJ-360-D Roll paper printer
- DLP-50 direct thermal label printer
- Epson TMU-295 Ticket printer
- Epson TMU-220 Roll paper printer

13. ANALOG OUTPUT INSTALLATION

Analog output installation and adjustment guide

1. Open the TLI indicator using socket wrench (remove 3 screws on top and 3 screws on bottom only). Locate J1 black pin socket on PCB. Insert analog output card into TLI indicator PCB pinhole socket J1, use 2 screw to fix this PCB to make sure it stays secure in socket.
On the analog option board make sure that K1 pins for 0-20mA or 4-20mA is closed, for 0-10VDC make sure that K2 pin is closed or connected.

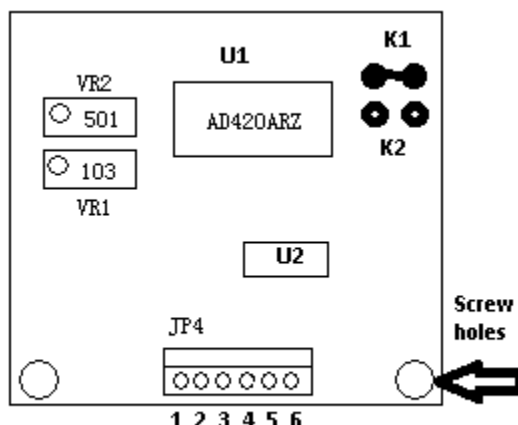

2. Connect external power supply (10-32VDC) positive (+) to connector JP4 pin 5, connect external power supply negative (GRD) to JP4 pin 6.

1. **For 4-20mA**, connect JP4 pin 1 as **output +**, connect JP4 pin 2 as **output - (GRD)**. External power supply should be connected to JP4 pin 5 as **input +**, and pin 6 as **input - (GRD)**.
2. **For 0-10VDC** connect JP4 pin 3 as **output +**, connect JP4 pin 3 as **output -**. External power supply should be connected to JP4 pin 5 as **input +**, and pin 6 as **input-**.

4. Calibrate the scale first then add 10-32VDC power on analog output card (external power source), check when the scale is at zero point the output will be 4mA or 0mA for **mA** output, or 0VDC for **VDC** output if the output is incorrect, please adjust **VR1** (10K) for zero point, then apply load to the scale and measure analog output if adjustment needed adjust **VR2** (500Ω) for span 20mA or 10VDC maximum output.

5. After adjusted, we recommend you to use drop of paint to fix VR1 and VR2

Note:

1. The both VR potentiometers already been adjusted at the factory, please don't adjust the VR if it's not necessary.

14.CONNECT TO LIGHT TOWER

9 PIN Connector	8 Wired Cable (Color)	Main board
PIN 1	Brown	VB
PIN 5	Black	GND
PIN 6	Green	OK
PIN 7	Yellow	LOW
PIN 8	Red	HI
PIN 9	Gray	BUZZ

The TLI indicator can be used for a variety of applications:

- Counting scales for general industrial and warehouse applications.
- Digital weighing/check-weighing scales.
- High performance platform scales with extensive software facilities including parts counting, percent weighing etc.
- Digital electronic scales for medical use.
- Retail price computing scales.
- Floor scales.
- Truck scale.
- Crane scales.
- Weighing indicator for platform scales, floor scales and truck scales.
- Hand push and pull gauge.
- Customize auto weighing systems.
- With light tower option it is a great product for hearing impaired people.

<p>Totalcomp Inc. 99 Reagent Lane Fair Lawn, NJ 07410</p>	<p>Tel.: 800-631-0347 Fax: 888-797-2288</p>
---	---

All information contained within this publication was to the best of our knowledge timely, complete and accurate when issued. However, we are not responsible for misimpressions which may result from the reading of this material.