

32-1053 REV 1

The TSC test stand is ruggedly built for testing up to 1,000 lbF of compression or tension force. A large hand wheel requires little effort, even at high loads, and a precision Acme screw and nut ensures smooth operation over time. The stand includes a loading table with threaded holes for fixture or grip mounting and a solid metal base (TSC) contains a storage pocket and holes for bench mounting. Available in vertical and horizontal configurations.

## Specifications

Load capacity:	1000 lb [5000 N]
Maximum travel:	3.50 in [89 mm]
Loading method:	Hand wheel
Travel rate:	0.1 in [2.5 mm] per hand wheel rev.
Weight:	
TSC	25 lb [11.4 kg]
TSCH	20 lb [9.0 kg]
Included accessories:	Tool kit, medium hook, large hook, 2 in dia. compression plate, force gauge mounting hardware
Warranty:	3 years (see individual statement for further details)

## Optional Equipment

Digital travel display TSC001	6 in [150 mm] travel, 0.0005 in [0.01 mm] resolution, 0.001 in [0.03 mm] accuracy, SPC output for automated data collection.
Horizontal / wall mounting kit TSA002	Converts the TSC to a TSCH (consists of two legs that support the column)
BGI mounting kit AC1004	If a BGI indicator with remote sensor is used with the TSC/TSCH, the BGI can be securely mounted to the side of the column with this adapter



The TSC and TSCH are shown in a tension spring testing application, with Series BG digital force gauge, digital travel display, and hooks

>> Digital travel display



## Dimensions

in [mm]

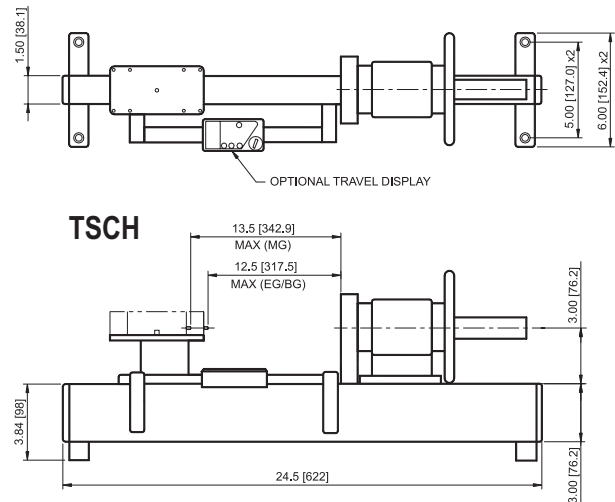
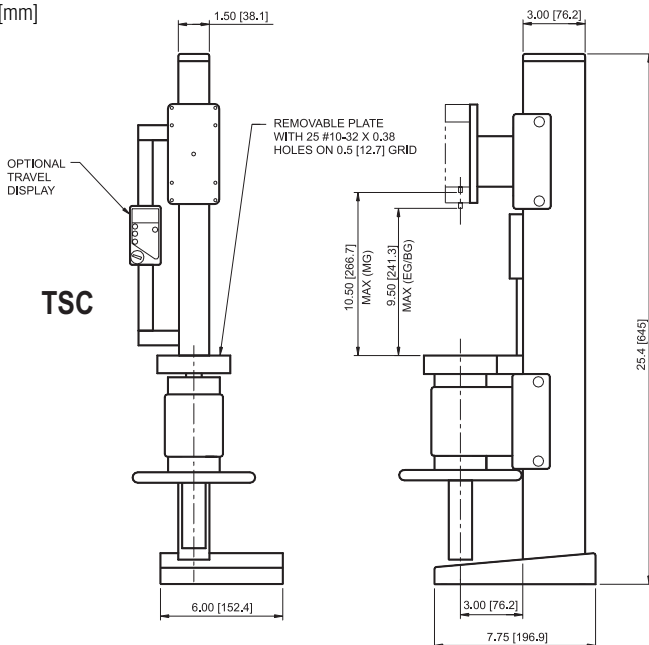

## Ordering Information

Model No.	Description
TSC	Test stand, hand wheel-operated, 1000 lbF, vertical
TSCH	Test stand, hand wheel-operated, 1000 lbF, horizontal
TSC001	Digital travel display for TSC/TSCH
TSA002	Horizontal / wall mounting kit for TSC
AC1004	Mounting kit, BGI to test stand