



Model 190 Indicator



Installation, Technical and Operation Manual

Introduction

Thank you for selecting and purchasing the Cardinal Model 190 Weight Indicator. The Model 190 indicator was built with quality and reliability at our factory in Webb City, Missouri and incorporates the latest in digital technology and innovative features for the weighing industry. Configuration and upgrades can easily be performed in the field, while still maintaining the rigid control the most demanding installations require. This flexibility insures the Model 190 will be able to meet your weight indicating needs for years to come.

The purpose of this manual is to provide you with a guide through installation, setup and operation of your new Model 190 Weight Indicator. Please read it thoroughly before attempting to install your indicator and keep it handy for future reference

Copyright



All rights reserved. Reproduction or use, without expressed written permission, of editorial or pictorial content, in any manner, is prohibited. No patent liability is assumed with respect to the use of the information contained herein.

Disclaimer

While every precaution has been taken in the preparation of this manual, the Seller assumes no responsibility for errors or omissions. Neither is any liability assumed for damages resulting from use of the information contained herein. All instructions and diagrams have been checked for accuracy and ease of application; however, success and safety in working with tools depend to a great extent upon the individual accuracy, skill and caution. For this reason the Seller is not able to guarantee the result of any procedure contained herein. Nor can they assume responsibility for any damage to property or injury to persons occasioned from the procedures. Persons engaging the procedures do so entirely at their own risk.

PRECAUTIONS

Before using this indicator, read this manual and pay special attention to all "WARNING" symbols:

	IMPORTANT		ELECTRICAL WARNING		STATIC SENSITIVE
---	------------------	---	-------------------------------	--	-----------------------------

FCC Compliance Statement

Warning! This equipment generates uses and can radiate radio frequency and if not installed and used in accordance with the instruction manual, may cause interference to radio communications. It has been tested and found to comply with the limits for a Class A computing device pursuant to Subpart J of Part 15 of FCC rules, which are designed to provide reasonable protection against such interference when operated in a commercial environment. Operation of this equipment in a residential area may cause interference in which case the user will be responsible to take whatever measures necessary to correct the interference.

You may find the booklet “How to Identify and Resolve Radio TV Interference Problems” prepared by the Federal Communications Commission helpful. It is available from the U.S. Government Printing Office, Washington, D.C. 20402. Stock No. 001-000-00315-4.

Proper Disposal

When this device reaches the end of its useful life, it must be properly disposed of. It must not be disposed of as unsorted municipal waste. Within the European Union, this device should be returned to the distributor from where it was purchased for proper disposal. This is in accordance with EU Directive 2002/96/EC. Within North America, the device should be disposed of in accordance with the local laws regarding the disposal of waste electrical and electronic equipment.

It is everyone's responsibility to help maintain the environment and to reduce the effects of hazardous substances contained in electrical and electronic equipment on human health. Please do your part by making certain that this device is properly disposed of. The symbol shown to the right indicates that this device must not be disposed of in unsorted municipal waste programs.

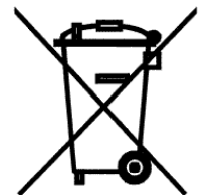

TABLE OF CONTENTS

- 1. SPECIFICATIONS 1**
 - 1.1 Standard Features 2
 - 1.2 Optional Features 2
- 2. PRECAUTIONS 3**
 - 2.1 Static Electricity 3
 - 2.2 Batteries 3
- 3. INSTALLATION 5**
 - 3.1 Site Preparation Requirements 5
 - 3.1.1 Environmental 5
 - 3.1.2 Electrical Power 6
 - 3.1.3 Electrical Noise Interference 7
 - 3.1.4 Transient Suppression 7
 - 3.2 Mounting 8
 - 3.3 Load Cell Connections 9
 - 3.4 Load Cell Connections with Over 30 Feet of Cable 11
 - 3.5 Sense and Dead Load Jumpers 11
 - 3.6 Serial and I/O Cable Installation 12
 - 3.7 Re-Installing the Front Panel 13
- 4. INDICATOR SETUP 15**
 - 4.1 Calibration Inhibit Jumper 15
 - 4.2 Calibration Data Entry 17
 - 4.3 Accessing Setup 19
 - 4.4 Settings 21
 - 4.5 Analog to Digital Filtering 27
 - 4.5.1 Filter Setting Recommendations 29
 - 4.6 Calibration 31
 - 4.6.1 Dual-Point with Zero (First Zero) Calibration 33
 - 4.6.2 Dual-Point without Zero (False Zero) Calibration 35
 - 4.6.3 Single-Point for Span Only (Last Zero) Calibration 37
 - 4.6.4 Single-Point for Zero Only (Only Zero) Calibration 39
 - 4.6.5 Multi-Point Calibration 41
 - 4.6.6 Calibration “[” Numbers 45

4.7 Set Gravity Constant.....	47
4.8 Serial Input/Output.....	49
4.9 Print Tab Settings	53
4.10 Fine Span Adjustment	57
4.11 Display High Resolution Weight	59
4.12 Key Lockout Feature.....	61
4.13 Options Setup.....	65
4.14 Function Setup	69
4.15 Display Backlight Color Setup	73
5. CALIBRATION SEAL	75
5.1 Installing the Calibration Seal	75
6. KEYPAD	77
6.1 Standard Key Functions	77
6.2 Fn/▲ Key Functions	81
6.3 Fn/▲ Key Combination Features.....	83
7. ANNUNCIATORS	85
7.1 Annunciators.....	85
7.2 Battery Status	88
8. INDICATOR SETUP REVIEW	89
8.1 Accessing Setup Review	89
9. OPERATION.....	91
9.1 Ticket Format Selection	91
9.2 Preset Weight Comparators	93
9.3 Hold Function	95
9.4 Count Function	97
9.5 Time and Date Functions.....	99
9.6 Peak Hold Function	101
9.7 Checkweigher.....	103
9.8 Live Weight Function	105
9.9 Accumulated Weight Function	107
10. ERROR MESSAGES	109
10.1 Before You Call Service.....	109
10.2 Error Codes	111

- 11. EVENT COUNTERS 113**
 - 11.1 Event Counters 113
 - 11.2 Accessing the Event Counters..... 113
- 12. TEST MODE/ DIAGNOSTICS..... 115**
 - 12.1 Test Mode/Diagnostics Features 115
 - 12.2 Accessing Test Mode/Diagnostics 115
- 13. PARTS IDENTIFICATION 117**
 - 13.1 Front Sub Assembly 117
 - 13.2 Rear Sub Assembly 118
 - 13.3 Power Supply Sub Assembly..... 119
 - 13.4 AC Wiring Detail 120

1. SPECIFICATIONS

Power Requirements:	100 to 240 VAC (50/60 Hz) at 0.4A Max.
Enclosure Type:	Thermoplastic IP69K wall or desk-mount
Enclosure Size:	9.4" W x 6.4" H x 3.7" D (239mm W x 163mm H x 93mm D)
Operating Environment:	Temperature: 14 to 104 °F (-10 to +40 °C) Humidity: 90% non-condensing (maximum)
Display:	Six digit, seven segment, 1.0" high Backlit LCD
Transducer Excitation:	5.15 VDC
Signal Input Range:	0.5 mV min. to 40 mV max. (with dead load boost)
Number of Load Cells:	6 each, 350 OHM minimum resistance
Load Cell Cable Length:	1500 feet maximum. 30 feet maximum without sense lines Consult factory for other requirements
Division Value:	1, 2, or 5 x 10, 1, 0.1, 0.01, 0.001 commercial 0 to 99, non-commercial
Sensitivity:	
NON-COMMERCIAL	0.15 uV/e
NTEP	0.5uV/e (Class III/IIIL)
CANADA	0.5uV/e (Class III/IIHHD)
Scale Divisions:	
NON-COMMERCIAL	100 to 240,000
NTEP	100 to 10,000 (Class III/IIIL)
CANADA	100 to 10,000 (Class III/IIHHD)
Internal Resolution:	1 part in 16,777,216
Tare Capacity:	Scale Capacity
Sample Rate:	1 to 100 samples per second, selectable
Auto Zero Range:	0.5 or 1 through 9 divisions
Weighing Units:	Pounds, Ounces, Kilograms, Grams
Keypad:	Color Coded Capacitive Touch type, 7 keys
Standard I/O:	(1) bi-directional RS232

1.1 Standard Features

Push button tare function
Gross, tare, net conversion
Selectable key lockout
Hi-Resolution mode
Adjustable filtering
Gross and Net accumulators
Single serial port
Remote input line for Zero, Tare, Gross and Print (1000 feet maximum)
Programmable print format using Visual Print or nControl (1 Visual Ticket available)
SMA level 2 compliant serial communications (For more information see <http://www.scalemanufacturers.org>)
Field re-programmable via PC interconnection
Test feature (performs display and internal tests)
Auto Shutoff and Sleep modes
Battery operation (Requires additional hardware and includes additional documentation)

1.2 Optional Features

Additional Serial Port*, Special Filtering, and Column Mounting

*This feature requires additional hardware and includes additional documentation.

2. PRECAUTIONS

2.1 Static Electricity



CAUTION! This device contains static sensitive circuit cards and components. Improper handling of these devices or printed circuit cards can result in damage to or destruction of the component or card. Such actual and/or consequential damage **IS NOT** covered under warranty and is the responsibility of the device owner. Electronic components must be handled only by qualified electronic technicians who follow the guidelines listed below.



ATTENTION! ALWAYS use a properly grounded wrist strap when handling, removing or installing electronic circuit cards or components. Make certain that the wrist strap ground lead is securely attached to an adequate ground. If you are uncertain of the quality of the ground, you should consult a licensed electrician.



ALWAYS handle printed circuit card assemblies by the outermost edges.

NEVER touch the components, component leads or connectors.

ALWAYS observe warning labels on static protective bags and packaging and never remove the card or component from the packaging until ready for use.

ALWAYS store and transport electronic printed circuit cards and components in anti-static protective bags or packaging.

2.2 Batteries

CAUTION: RISK OF EXPLOSION IF BATTERY IS REPLACED BY AN INCORRECT TYPE. DISPOSE OF USED BATTERIES ACCORDING TO THE INSTRUCTIONS.

ATTENTION: RISQUE D'EXPLOSION SI LA BATTERIES EST REMPLAC'E PAR UN TYPE INCORRECT. REJETEZ LES BATTERIES UTILISE'ES SELON LES INSTRUCTIONS.

3. INSTALLATION

3.1 Site Preparation Requirements

The Cardinal Model 190 indicator is a precision weight-measuring instrument. As with any precision instrument, it requires an acceptable environment to operate at peak performance and reliability. This section is provided to assist you in obtaining such an environment.

3.1.1 Environmental

The 190 indicator meets or exceeds all certification requirements within a temperature range of 14 to 104 °F (-10 to +40 °C).

In order to keep cooling requirements to a minimum, the indicator should be placed out of direct sunlight and to provide adequate air circulation, keep the area around the indicator clear.

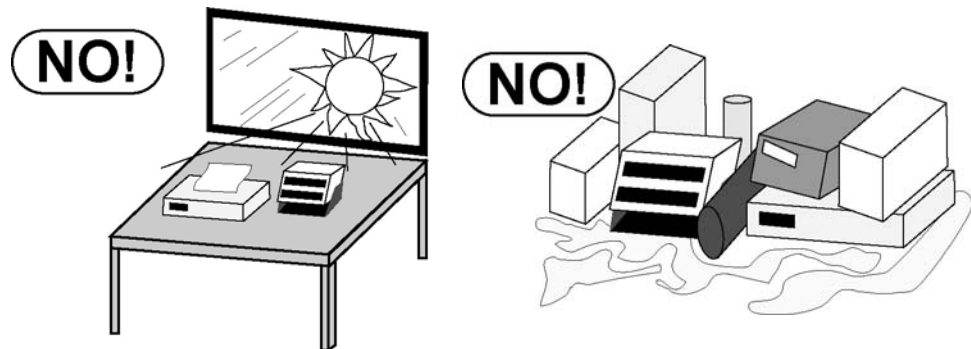

Make certain the indicator is not directly in front of a heating or cooling vent. Such a location will subject the indicator to sudden temperature changes, which may result in unstable weight readings.

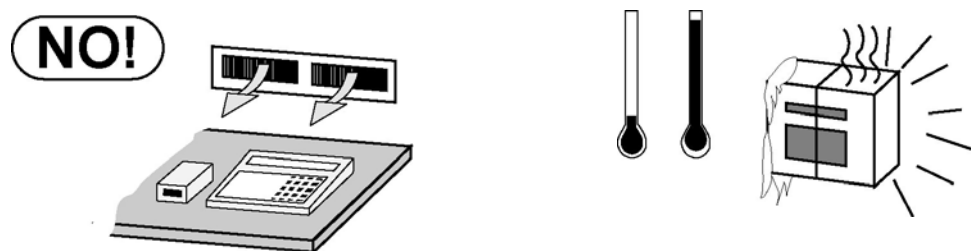

Insure that the indicator has good, clean AC power and is properly grounded. In areas subject to lightning strikes, additional protection to minimize lightning damage, such as surge suppressors, should be installed.



3.1.2 Electrical Power

The 190 has been designed to operate from 100 to 240 VAC @ 0.4A Max. at 50/60 Hz. Note that a special order is not required for operation at 230/240 VAC.



CAUTION! - To avoid electrical hazard and possible damage to the indicator, DO NOT, under any circumstance, cut, remove, alter, or in any way bypass the power cord grounding prong.

The socket-outlet supplying power to the indicator should be on a separate circuit from the distribution panel and dedicated to the exclusive use of the indicator.

The socket-outlet shall be installed near the equipment and shall be easily accessible. Note that the power cord on the 190 serves as the power disconnect.

The wiring should conform to national and local electrical codes and ordinances and should be approved by the local inspector to assure compliance.

For outdoor operations, the socket-outlet must provide GFCI (ground fault circuit interrupter) protection.

On installations requiring 230/240 VAC power, **it is the responsibility of the customer** to have a qualified electrician install the proper power cord plug that conforms to national electrical codes and local codes and ordinances.

3.1.3 Electrical Noise Interference

To prevent electrical noise interference, make certain all other wall outlets for use with air conditioning and heating equipment, lighting or other equipment with heavily inductive loads, such as welders, motors and solenoids are on circuits separate from the indicator. Many of these disturbances originate within the building itself and can seriously affect the operation of the instrument. These sources of disturbances must be identified and steps must be taken to prevent possible adverse effects on the instrument. Examples of available alternatives include isolation transformers, power regulators, uninterruptible power supplies, or simple line filters.

3.1.4 Transient Suppression

The following recommendations will help to reduce transients:

- Always use shielded cables to connect signal wires to the weight indicator.
- Secure the cables in the cable clips provided inside the indicator.
- Connect the cable shield (indicator end only) to a ground point inside the indicator. Keep wires that extend beyond the shield as short as possible.
- Do not run load cell or signal cables from the weight indicator along side or parallel to wiring carrying AC power. If unavoidable, position the load cell and signal cables a minimum of 24" away from all AC wiring.
- Always use arc suppressors across all AC power relay contacts (see recommendations at www.paktron.com/pdf/Quencharch_QRL.pdf).
- Use zero voltage switching relays, optically isolated if possible.

3.2 Mounting

Before beginning installation of your Model 190 Indicator, make certain that it has been received in good condition. Carefully remove it from the shipping carton and inspect it for any evidence of damage (such as exterior dents or scratches) that may have taken place during shipment. Keep the carton and packing material for return shipment if it should become necessary. It is the responsibility of the purchaser to file all claims for any damages or loss incurred during transit.

NOTE! Should your Model 190 indicator come already installed on a scale, the following information describing the installation of the indicator does not apply.

The Model 190 indicator is housed in a Thermoplastic IP69K wall or desk-mount enclosure. The gimbal may be mounted on a desktop or other smooth, flat, horizontal surface or may be mounted on a wall. Refer to Figure No. 1 for a layout of wall-mounting bolts.

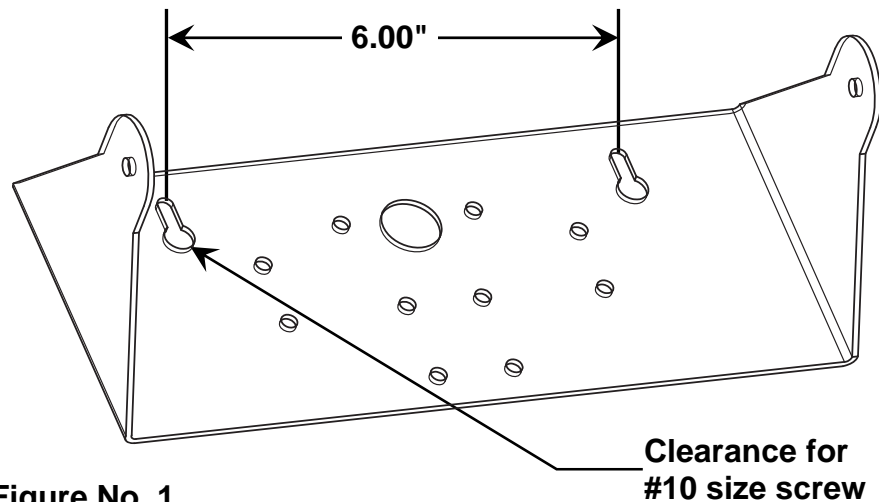

Figure No. 1

If wall mounted, make certain the mounting surface is strong enough to support the indicator. The mounting location should be where the display is easily viewed while being close enough to provide the operator easy access to the keypad. Carefully lay out the mounting hole locations, then drill and install the anchor bolts. Attach the gimbal to the wall and securely tighten the retaining bolts.

3.3 Load Cell Connections

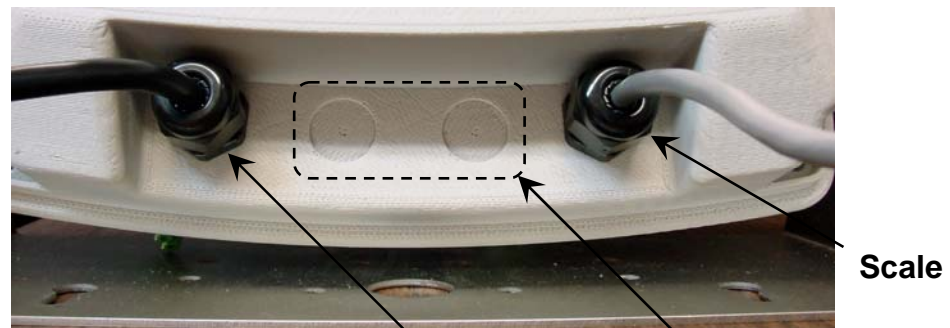
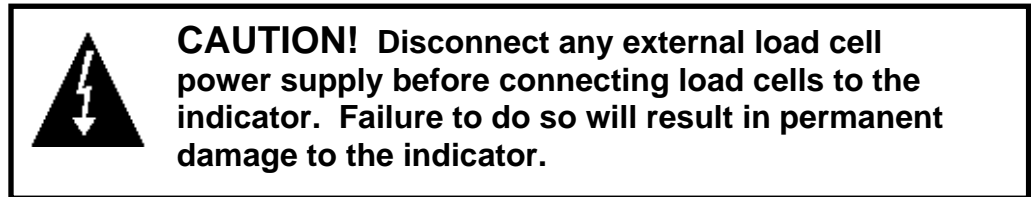

Figure No. 2

AC Power
100-240 VAC
0.4 Amp

I/O
(Serial, Isolated
Inputs/Outputs)

- 3.3.1. Remove the 4 screws securing the front panel to the rear housing.
- 3.3.2. Referring to Figure No. 2, choose a gland connector for the load cell cable and loosen it.
- 3.3.3. Slip the single cable from the load cell or load cell junction box through the gland connector and into the enclosure.
- 3.3.4. Referring to Figure No. 3, remove 3 inches of the outer insulation jacket.
- 3.3.5. Next, remove 1/4 inch of insulation from each of the six wires and shield (with sense leads) or four wires and shield (without sense leads).

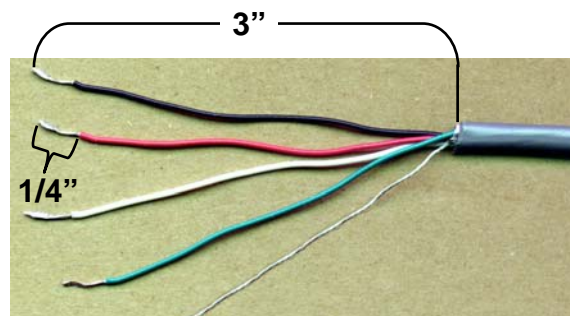

Figure No. 3

3.3.6. Remove the 7-connector terminal block connector from P5 on the 190 main board. Grasp the terminal block connector and lift straight up away from the board.

3.3.7. Referring to the table below and the labels on the circuit board for terminal connections, connect each wire to the terminal block.

Load Cell Wiring Table

Board Label	Function	Board Label	Function
+EXC	+ EXCITATION	-SIG	- SIGNAL
+SEN	+ SENSE	-SEN	- SENSE
+SIG	+ SIGNAL	-EXC	- EXCITATION
SHLD	SHIELD (Connect the load cell cable shield wire here).		

3.3.8. To terminate a wire, loosen the screws in the terminal block and then insert the wire into the terminal opening. Tighten the screw to secure the wire in place. See Figure No. 4.

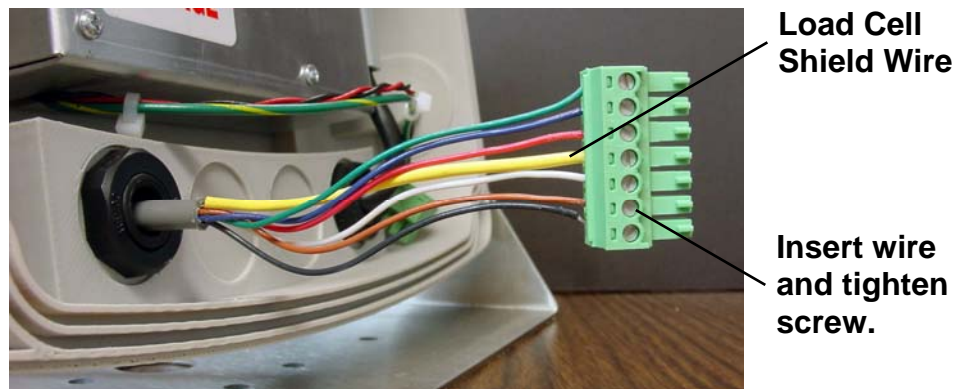

Figure No. 4

3.3.9. Repeat the procedure until all wires are in place.

3.3.10. After all terminations have been made, remove the excess cable from the enclosure.

3.4 Load Cell Connections with Over 30 Feet of Cable

For installations with over 30 feet of cable between the indicator and the load cells, sense wires should be used. The sense wires must be connected between the +SENS, -SENS terminals on the indicator and the +EXCITATION, -EXCITATION wires of the load cells or the +SENS, -SENS terminals of the load cell trim board or the section seal trim board.

3.5 Sense and Dead Load Jumpers

J1 (+SEN) and J2 (-SEN) – Sense Jumpers

If the sense leads are NOT used, you must install the +SEN and -SEN jumpers at J1 and J2 (near the P5 terminal block). These jumpers connect the sense leads to the excitation leads. If sense leads ARE used (as in motor truck scales or installations with over 30 feet between the indicator and load cells), these jumpers should be open (on one pin only) or removed.

J3 (DEAD LOAD) – Dead Load Boost Jumper

For scales with very low dead loads (less than 10% of the combined load cell capacity), connect the DEAD LOAD (dead load boost) jumper J3 (near the P5 terminal block).

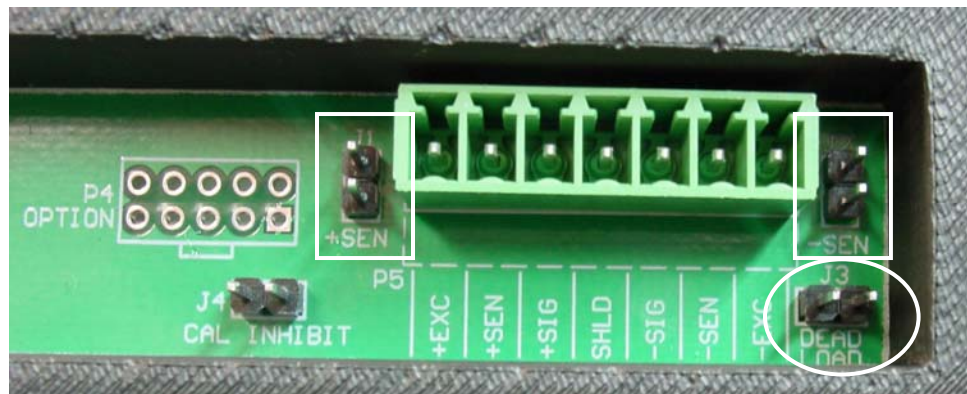

Figure No. 5

3.6 Serial and I/O Cable Installation

- 3.6.1. Remove the 4 screws securing the front panel to the rear housing and then loosen a gland connector for the serial cable. Refer to Figure No. 2 for an illustration of the connector layout.
- 3.6.2. Slip the serial cable through the gland connector and into the enclosure.
- 3.6.3. Remove 3" of the outer insulation jacket then remove 1/4" of insulation from each of the wires (refer to Figure No. 3).
- 3.6.4. Remove the 9-connector terminal block connector from P3 on the 190 main board. Grasp the terminal block connector and lift straight up away from the board.
- 3.6.5. Referring to the table below and the labels on the circuit board for terminal connections, connect each wire to the terminal block.
- 3.6.6. To terminate a wire, loosen the screws in the terminal block and then insert the wire into the terminal opening. Tighten the screw to secure the wire in place.
- 3.6.7. Repeat the procedure until all wires are in place.
- 3.6.8. After all terminations have been made, remove the excess cable from the enclosure.

SERIAL INTERFACE		INPUT/OUTPUTS	
Terminal	Function	Terminal	Function
1	TXD	5	IN1
2	RXD	6	OUT1
3	GND	7	OUT2
4	+12-24 DC	8	OUT3
		9	COMMON

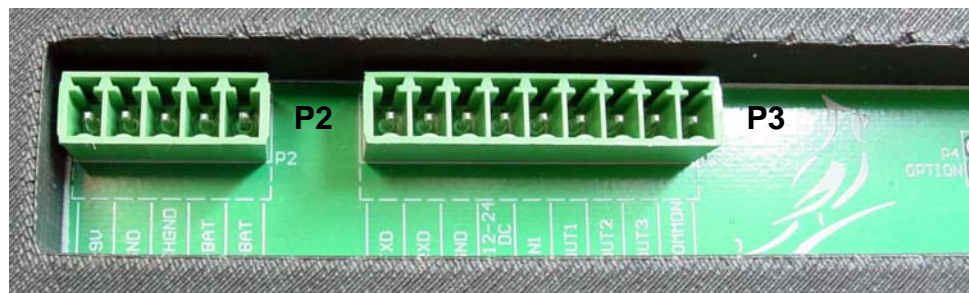

Figure No. 6

3.7 Re-Installing the Front Panel

- 3.7.1.** After all terminations have been made, remove the excess cable from the indicator enclosure and securely tighten each of the cable gland connectors.
- 3.7.2.** Use a wrench to insure the gland connectors are tight (to maintain a water-tight seal) but do not over-tighten them.
- 3.7.3.** Make certain no cables or wires are exposed between the rear housing and front panel and then place the front panel onto the rear housing.
- 3.7.4.** Secure with the 4 screws removed earlier.

4. INDICATOR SETUP

4.1 Calibration Inhibit Jumper

Your Model 190 indicator has been thoroughly tested and calibrated before being shipped to you. If you received the indicator attached to a scale, calibration is not necessary. If the indicator is being connected to a scale for the first time or recalibration is necessary for other reasons, proceed as indicated.

Calibration and Setup of the indicator is accomplished entirely by the keypad. However, it may require changing the position of the calibration inhibit jumper depending on the method of sealing required by your local metrology laws.

The calibration inhibit jumper (**J4**) is located on the main printed circuit board and can **only** be accessed by removing the front panel of the indicator.

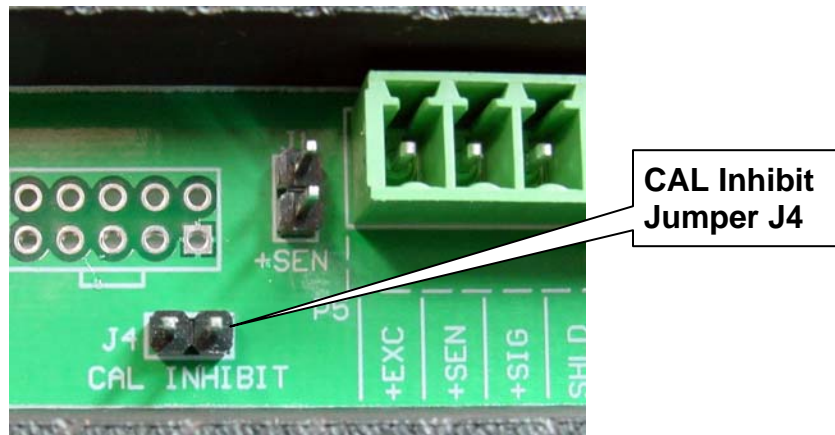

Figure No. 7



IMPORTANT! The following setup parameters **CAN NOT** be changed with the calibration inhibit jumper (J4) installed:

<i>USA</i>	Domestic or International
<i>LFT</i>	Legal For Trade
<i>Unit 1</i>	Weighing Units 1 (Primary Units)
<i>Int</i>	Interval Setting
<i>dPP</i>	Decimal Point Precision
<i>CAP</i>	Capacity
<i>Unit 2</i>	Weighing Units 2 (Secondary Units)
<i>trR</i>	Zero Tracking Range
<i>trL</i>	4% Zero Limit
<i>PU0</i>	Power Up Zero
<i>dFLT</i>	Digital Filter Number
<i>F</i>	Filter Level Amount
<i>b</i>	Filter Break Range
<i>sr</i>	Sample Rate
<i>UnS</i>	Motion Range
<i>SC</i>	Stable Count

4.2 Calibration Data Entry



The Model 190 uses a capacitive touch keypad that requires a “finger touch” to function. The keypad will not operate with other items such as pen, pencil or tools.

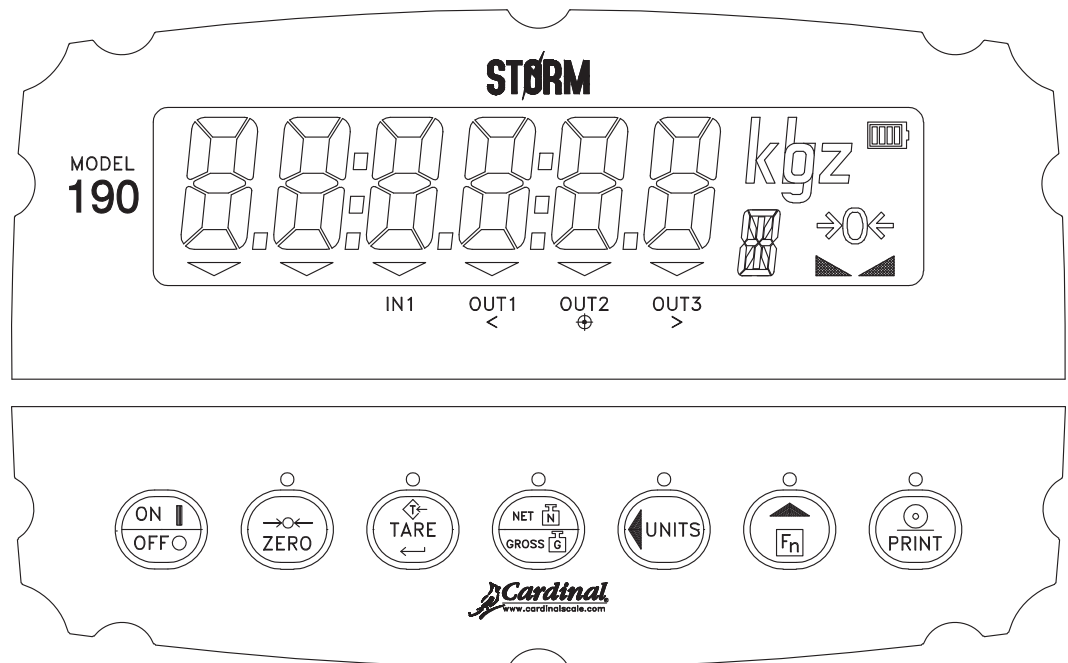

Figure No. 8

During the indicator setup and calibration process it will be necessary to enter operational parameters via the 190 keypad.

Pressing the **TARE** \leftarrow key will cause the data entered or displayed to be retained and the 190 to advance to the next prompt.

The functions of numeric keys are replaced by using the **UNITS/** \leftarrow and the **Fn/** \blacktriangle keys.

The cursor location is identified by the blinking character and can be advanced to the left to the next position by pressing the **UNITS/** \leftarrow key.

Pressing the **Fn/** \blacktriangle key will change the blinking character to the next value or setting. Continue to press this key to "toggle" between the different available values or settings for the setup parameter.

Pressing the **Fn/** \blacktriangle key when a setup parameter (not a parameter value or setting) is displayed, will "backup" to the previous parameter prompt.

4.3 Accessing Setup

- 4.3.1.** With the 190 ON, press the **Fn/▲** and **UNITS/◀** key simultaneously
- 4.3.2.** Hold both keys until the display changes to *SEtUP*.
- 4.3.3.** Release the keys to begin setup.
- 4.3.4.** Press the **UNITS/◀** key to step to the beginning point of each setup section.

<i>SEtUP</i>	See Note Below	Setup Mode (starts at <i>USR=</i> prompt)
<i>R-d</i>	<i>R-d?</i>	Analog to Digital Filtering (starts at <i>dFLt=</i> prompt)
<i>CAL</i>	<i>CAL?</i>	Calibration (starts at <i>CAL l=</i> prompt)
<i>SEtGC</i>	<i>SEtGC?</i>	Set Gravity Constant (starts at <i>CAL GC=</i> prompt)
<i>S io</i>	<i>S io?</i>	Serial Input/Output (starts at <i>brUD=</i> prompt)
<i>Pr int</i>	<i>Pr int?</i>	Print Tab Settings (starts at <i>Port=</i> prompt)
<i>F SPAn</i>	<i>FSPAn?</i>	Fine Span Adjustment
<i>H i rES</i>	<i>H i rES?</i>	Display High Resolution Weight
<i>LoCoUt</i>	<i>LoCoUt?</i>	Key Lockout Feature Setup
<i>oPt ion</i>	<i>oPt?</i>	Configuration for Indicator Option Boards
<i>FUnC</i>	<i>FUnC?</i>	Function Setup
<i>CoLoRS</i>	<i>CoLoR?</i>	Display Colors Setup

- 4.3.5** If you press the **TARE ↵** key at the *SEtUP* prompt, you may proceed through to the next section (up to and including *CoLoRS*) by pressing the **TARE ↵** key.
- 4.3.6** To exit setup, press the **Fn/▲** key with any of the menu selections displayed.

NOTE! With the exception of the *SEtUP* prompt, the prompts displayed for each section are different if you push the **UNITS/◀** key to step through the prompts instead of pressing the **TARE ↵** key to proceed through the section. *For example*, if you press the **UNITS/◀** key with the *SEtUP* displayed, the next prompt displayed will be *R-d*. If you step through the setup prompts by pressing the **TARE ↵** key, the next prompt displayed will be *R-d?*. In addition, at a prompt with the *?* displayed, you must press the **TARE ↵** key again to proceed with that section. To skip the section and advance you to the next menu selection, press the **TARE ↵** key twice.

4.4 Settings



IMPORTANT! Calibration and configuration parameters are not stored in the non-volatile memory until setup is left. If power is lost while in setup mode, any changes made will be lost and the indicator will revert to the previous configuration.

SETUP

USR: (Domestic or International)

With *SETUP* displayed, press the **TARE** \leftarrow key. The display will change to *USR:*. Press the **TARE** \leftarrow key to show the current setting. If the setting displayed is acceptable, press the **TARE** \leftarrow key again to save it. Otherwise, use the **Fn/▲** key to toggle to a new setting and then press the **TARE** \leftarrow key to save it.

YES (Domestic)

err: (4% Zero Range) = no
CRP (Capacity) = + 4% to OC
 Date Format = MM/DD/YY

no (International)

err: (4% Zero Range) = yes
CRP (Capacity) = + 9 grads to OC
 Date Format = DD/MM/YY

LFL: (Legal For Trade)

Press the **TARE** \leftarrow key to show the current setting. If the setting displayed is acceptable, press the **TARE** \leftarrow key again to save it. Otherwise, use the **Fn/▲** key to toggle to a new setting and then press the **TARE** \leftarrow key to save it.

YES = Interval Settings (*Int*:) *no* = Interval Setting (*Int*:) is
 allowed are: 1, 2, 5, 10, 20, 50 selectable from 1 to 99.

When both *LFL: YES* and *USR: YES*, the followings results occur:

Scale must have between 100 and 10,000 divisions
 Inhibit serial data during input
err: (Zero Tracking Range) = 0.5 or 0 to 3
err: (4% Zero Range) = no
CRP (Capacity) = + 4% to OC

When *LFL: YES* and *USR: no*, the followings results occur:

UnS: (Motion Range) = 1
err: (4% Zero Range) = yes
CRP (Capacity) = + 9 grads to OC

Unit 1: (Weighing Unit 1)

Press the **TARE** \leftarrow key to show the current setting. If the setting displayed is acceptable, press the **TARE** \leftarrow key again to save it. Otherwise, use the **Fn/▲** key to toggle to a new setting and then press the **TARE** \leftarrow key to save it. Allowable settings are:

- | | |
|-----------------|--------------------|
| 1 = lb (pounds) | 2 = kg (kilograms) |
| 3 = oz (ounces) | 4 = g (grams) |

Int: (Interval Setting)

Press the **TARE** \leftarrow key to show the current setting.

If **LFE = 455**, use the **Fn/▲** key to toggle to a new setting and then press the **TARE** \leftarrow key to save it. Allowable settings are: 1, 2, 5, 10, 20 or 50.

If **LFE = 00**, use the **Fn/▲** and **UNITS/◀** keys to enter a new setting and then press the **TARE** \leftarrow key to save it. Allowable settings are: 1 through 99.

When the setting displayed is acceptable, press the **TARE** \leftarrow key again to save it.

dPP: (Decimal Point Setting)

Press the **TARE** \leftarrow key to show the current setting. If the setting displayed is acceptable, press the **TARE** \leftarrow key again to save it. Otherwise, use the **Fn/▲** key to toggle to a new setting and then press the **TARE** \leftarrow key to save it. Allowable settings are:

- | | |
|-------------|-------------|
| 0 = XXXXXX | 1 = XXXXX.X |
| 2 = XXXX.XX | 3 = XXX.XXX |

CRP: (Capacity)

Press the **TARE** \leftarrow key to show the current setting. If the setting displayed is acceptable, press the **TARE** \leftarrow key again to save it. Otherwise, use the **Fn/▲** and **UNITS/◀** keys to enter a new setting and then press the **TARE** \leftarrow key to save it. Allowable capacity settings are: 1 through 999,999.

Unit 2: (Weighing Unit 2)

Press the **TARE** \leftarrow key to show the current setting. If the setting displayed is acceptable, press the **TARE** \leftarrow key again to save it. Otherwise, use the **Fn/▲** key to toggle to a new setting and then press the **TARE** \leftarrow key to save it. Allowable settings are:

0 = none	1 = lb (pounds)	2 = kg (kilograms)
3 = oz (ounces)	4 = g (grams)	



NOTE! The selection for *Unit 2* can not be the same as *Unit 1*. In addition, dependent upon the selection for *Unit 1*, the interval and decimal point settings, not all unit combinations are available.

Zero: (Zero Tracking Range)

Press the **TARE** \leftarrow key to show the current setting assigned to the Automatic Zero Tracking Range. This is the value in scale divisions that will be automatically zeroed off. If the setting displayed is acceptable, press the **TARE** \leftarrow key again to save it. Otherwise, use the **Fn/▲** key to toggle to a new setting and then press the **TARE** \leftarrow key to save it. Allowable values are: 0 (disables Zero Tracking), 0.5, or 1 through 9.

Zero: (4% Zero Range)

Press the **TARE** \leftarrow key to show the current setting. If the setting displayed is acceptable, press the **TARE** \leftarrow key again to save it. Otherwise, use the **Fn/▲** key to toggle to a new setting and then press the **TARE** \leftarrow key to save it.

Zero: YES	Zero: no
4% of scale capacity	Full capacity (no limit)

Power-Up: (Power-Up Zero Feature)

Press the **TARE** \leftarrow key to show the current setting. If the setting displayed is acceptable, press the **TARE** \leftarrow key again to save it. Otherwise, use the **Fn/▲** key to toggle to a new setting and then press the **TARE** \leftarrow key to save it.

Power-Up: YES	Power-Up: no
Automatic Re-Zero on Power-Up	No Re-Zero on Power-Up

td = (12 or 24 Time Format)

Press the **TARE** \leftarrow key to show the current setting. If the setting displayed is acceptable, press the **TARE** \leftarrow key again to save it. Ot

herwise, use the **Fn/▲** key to toggle to a new setting and then press the **TARE** \leftarrow key to save it. Note that in the 24 hour format, 12 is added to all times after noon, i.e. 3 PM would be 1500.

td = 12	td = 24
12 hour clock	24 hour clock
(3PM displays 3:00)	(3PM displays 15:00)

td in = X,Y (Digital Input)

Press the **TARE** \leftarrow key to show the current setting. If the setting displayed is acceptable, press the **TARE** \leftarrow key again to save it. Otherwise, use the **Fn/▲** key to select the X, Y settings for the Digital Input, and then press the **TARE** \leftarrow key to save it. where:

- X = Input transition which activates selected keypad function
(0=open to closed, 1=closed to open)
- Y = Keypad function which will be performed

- 0 = Digital Input is disabled
- 1 = **ZERO** key function is performed when input goes from open to closed
- 2 = **PRINT** key function is performed when input goes from open to closed
- 3 = **TARE** key function is performed when input goes from open to closed
- 4 = **NET/GROSS** key function is performed when input goes from open to closed
- 11 = **ZERO** key function is performed when input goes from closed to open
- 12 = **PRINT** key function is performed when input goes from closed to open
- 13 = **TARE** key function is performed when input goes from closed to open
- 14 = **NET/GROSS** key function is performed when input goes from closed to open

d out = X,Y (Digital Output)

Press the **TARE** \leftarrow key to show the current setting. If the setting displayed is acceptable, press the **TARE** \leftarrow key again to save it. Otherwise, use the **Fn/▲** key to select the X, Y settings for the Digital Output, and then press the **TARE** \leftarrow key to save it.

where:

X = State below cutoff

(0=Output connected to common, 1=Output not connected to common)

Y = Preset Number or Checkweigher Mode

- 0 = Digital Output is disabled
- 1 = Output connected to common before cutoff with 1 active Preset
- 2 = Output connected to common before cutoff with 2 active Presets
- 3 = Output connected to common before cutoff with 3 active Presets
- 4 = Output connected to common before cutoff on Checkweigher Mode
- 11 = Output not connected to common before cutoff with 1 active Preset
- 12 = Output not connected to common before cutoff with 2 active Presets
- 13 = Output not connected to common before cutoff with 3 active Presets
- 14 = Output not connected to common before cutoff on Checkweigher Mode

SLEEP- (Sleep Mode Feature)

The Sleep Mode feature conserves battery power when the indicator remains unused for a selected period of time. With the feature enabled, the display will be blank.

Press the **TARE** ↵ key to show the current status of this feature. If a number other than 0 is shown, this feature is selected and the number shown corresponds to the number of minutes of a stable zero weight reading before the indicator enters the sleep mode.

If the setting displayed is acceptable, press the **TARE** ↵ key again to save it. Otherwise, use the **Fn/▲** and **UNITS/◀** keys to enter a new setting (0 to 10) and then press the **TARE** ↵ key to store the new setting.

NOTE! Selecting 0 disables this feature.

Auto Shutoff- (Auto Shutoff)

The Automatic Shutoff feature will automatically turn the indicator off (when it is not in use) after a predetermined period of inactivity to prolong battery life. To turn the indicator back on you must press the **ON/OFF** key.

Press the **TARE** ↵ key to show the current status for this feature. A number other than 0 indicates that the auto shutoff feature is enabled and the displayed number corresponds to the number of minutes of stable weight displayed before the indicator is turned off automatically.

If the setting displayed is acceptable, press the **TARE** ↵ key again to save it. Otherwise, use the **Fn/▲** and **UNITS/◀** keys to enter a new setting (0 to 10) and then press the **TARE** ↵ key to store the new setting.

NOTE! Selecting 0 disables the Auto-Shutoff feature.

4.5 Analog to Digital Filtering

R-d

With *R-d* displayed, press the **TARE** \leftarrow key. The display will change to *dFLt=*. Proceed to the *dFLt=* parameter.

R-d?

With *R-d?* displayed, press the **TARE** \leftarrow key. The display will change to *no*. Press the **Fn/▲** key to toggle to *YES* and then press the **TARE** \leftarrow key. The display will change to *dFLt=*. Proceed to the *dFLt=* parameter. Otherwise, to skip the Analog to Digital Filtering setup, press the **TARE** \leftarrow key to advance to the *CRP?* prompt.

dFLt= (Digital Filtering)

With *dFLt=* displayed, press the **TARE** \leftarrow key to show the current setting. If the setting displayed is acceptable, press the **TARE** \leftarrow key to save it. Otherwise, use the **Fn/▲** key to toggle to a new setting and then press the **TARE** \leftarrow key to save it. Allowable settings are: 0, 1, 2 or 3. Note, that if you select 3 (Custom Filtering) two additional prompts will be displayed.

dFLt=

- 0* Filter Level = 2, Break Range = 1
- 1* Filter Level = 6, Break Range = 12, Sample Rate = 2
- 2* Filter Level = 20, Break Range = 12, Sample Rate = 1
- 3 CUSTOM FILTERING

NOTE! The prompts, *F=* (Filter Level) and *b=* (Break Range) will only be displayed if you selected 3 (Custom Filtering) for the *dFLt=* (Digital Filtering) prompt.

* Digital Filtering (*dFLt=*) selections 0, 1 and 2 have fixed factory settings for Filter Level, Break Range and Sample Rate.

F = (Filter Level)

The filter level is a number from 1 to 99 that corresponds to the level of filtering with 1 being the least and 99 being the greatest. Press the **TARE** \leftarrow key to show the current setting. To accept the setting displayed, press the **TARE** \leftarrow key again to save it. Otherwise, use the **Fn/▲** and **UNITS/◀** keys to enter a new setting (1 to 99) and then press the **TARE** \leftarrow key to save it.

b = (Break Range)

The break range is a number from 1 to 255 that corresponds to the number of division change to break out of the filtering. Press the **TARE** \leftarrow key to show the current setting for the break range. To keep the displayed setting, press the **TARE** \leftarrow key. Otherwise, use the **Fn/▲** and **UNITS/◀** keys to enter a new setting (1 to 255) and then press the **TARE** \leftarrow key to save it. **NOTE!** Selecting 0 disables this feature.

5r = (Sample Rate)

Press the **TARE** \leftarrow key to show the current setting for the sample rate. The setting displayed is the sample rate in samples per second. Press the **TARE** \leftarrow key to save the displayed setting or use the **Fn/▲** and **UNITS/◀** keys to enter a new setting (1 to 120) and then press the **TARE** \leftarrow key to save it.

Un5 = (Motion Range)

Press the **TARE** \leftarrow key to view the current setting for the range of motion detection. If the displayed setting is acceptable, press the **TARE** \leftarrow key to save it. Otherwise, use the **Fn/▲** and **UNITS/◀** keys to enter a new range (the number of divisions of change permitted before indicating unstable) and then press the **TARE** \leftarrow key to save the new setting. Allowable range values are: 0 through 99 divisions.

5ℓ = (Stable Count)

Press the **TARE** \leftarrow key to view the current setting for the number of consecutive stable weight readings before indicating stable weight. This helps filter weight readings for stability when trying to capture stable weight. If the displayed setting is acceptable, press the **TARE** \leftarrow key to save it. Otherwise, use the **Fn/▲** and **UNITS/◀** keys to enter a new setting and press the **TARE** \leftarrow key to save the new setting. Allowable values for the stable count are: 1 through 255.

4.5.1 Filter Setting Recommendations

Non Critical Sample Rate

If the sample rate is not critical, as in static weighing, set:

$$dFLt = 0^* (F = 2, b = 1),$$

$$dFLt = 1^* (F = 6, b = 12, Sr = 2), \text{ or}$$

$$dFLt = 2^* (F = 20, b = 12, Sr = 1).$$

* Digital Filtering ($dFLt$) selections 0, 1 and 2 have fixed factory settings for Filter Level, Break Range and Sample Rate.

Critical Sample Rate

If the sample rate is critical, as in a filling operation, use Custom Filtering (set $dFLt$ to "3").

1. Sr : SAMPLE RATE (1 to 120 samples/second) determination:

Set the sample rate as close as possible to produce a display graduation change for every graduation of material added to the scale.

$$\frac{\text{Material Flow Rate (lbs/second)}}{\text{Resolution}} =$$

$$\text{EXAMPLE: } \frac{100\text{lbs/sec}}{10\text{lbs}} = 10\text{s/s} = Sr$$

2. b : BREAK RANGE (1 to 255 graduations) determination:

Turn the filtering off by setting the $dFLt$ setting to "0". Operate the system as it will be normally used and, by observation, determine the number of grads of instability that needs to be filtered out. Set the break range (b) to that value.

$$\frac{\text{Weight Change}}{\text{Graduation Value}} = b$$

EXAMPLE: 20,000 x 10lb capacity scale with 800lb variation in the weight display.

$$\frac{800}{10} = b = 80$$

3. F : FILTER SETTING (1 to 99) determination: Set to desired results.
4. If stability is unacceptable with any setting of F , reduce the sample rate and/or increase the break range, b setting for increased filtering.

4.6 Calibration

The 190 indicator has six modes that can be used to perform calibration. Four of the modes require a test load or test weights, one requires the scale to be empty (and at zero) and the last uses the calibration “C” numbers from a previous calibration.

CAL

With *CAL* displayed, press the **TARE** \leftarrow key. The display will change to *CAL 1=*. Proceed to the *CAL 1=* parameter.

CAL²

With *CAL²* displayed, press the **TARE** \leftarrow key. The display will change to *no*. Press the **Fn/▲** key to toggle to *YES* and then press the **TARE** \leftarrow key. The display will change to *CAL 1=*. Proceed to the *CAL 1=* parameter. Otherwise, to skip Calibration, press the **TARE** \leftarrow key to advance to the *S 10²* prompt.

During calibration it will be necessary to enter values using the 190 keypad.

Pressing the **TARE** \leftarrow key will cause the data entered or displayed to be retained and the 190 to advance to the next prompt.

The functions of numeric keys are replaced by using the **UNITS/◀** and the **Fn/▲** keys.

The cursor location is identified by the blinking character and can be advanced to the left to the next position by pressing the **UNITS/◀** key.

Pressing the **Fn/▲** key will change the blinking character to the next value.

4.6.1 Dual-Point with Zero (First Zero) Calibration

This is a standard calibration method requiring one weight, an empty scale and has one conversion factor. This method uses two calibration points ($CR_L 1=$ and $CR_L 2=$) to establish a zero (no load) calibration value and to span the indicator. The two points correspond to zero weight and the test load or test weight and can be applied in any order. This method should be used for first-time calibration and complete recalibration.

$CR_L 1=$ – First Calibration Weight

1. The display will show $CR_L 1=$. This is the first of two calibration weights. This weight could be ZERO (NO LOAD) or the TEST WEIGHTS (TEST LOAD).
2. Press the **TARE** \leftarrow key to view the current setting.
3. If the first calibration weight is to be ZERO (NO LOAD), press the **TARE** \leftarrow key.
4. If the first calibration weight is to be the TEST WEIGHTS (TEST LOAD), use the **UNITS/◀** and **Fn/▲** keys to input the value of the test weights.
5. Place the weights on the scale platform, then press the **TARE** \leftarrow key.
6. Starting at the left and proceeding right, a series of dashes will appear on the display.
7. Next, starting at the left and proceeding right, the dashes will disappear, after which the display will show: $CR_L 2=$.

$CR_L 2=$ – Second Calibration Weight

1. The display will show $CR_L 2=$. This is the second of two calibration weights. This weight could be ZERO (NO LOAD) or the TEST WEIGHTS (TEST LOAD).
2. Press the **TARE** \leftarrow key to view the current setting.
3. If the second calibration weight is to be ZERO (NO LOAD), press the **TARE** \leftarrow key.
4. If the first calibration weight is to be the TEST WEIGHTS (TEST LOAD), use the **UNITS/◀** and **Fn/▲** keys to input the value of the test weights.
5. Place the weights on the scale platform, then press the **TARE** \leftarrow key.
6. Starting at the left and proceeding right, a series of dashes will appear on the display.
7. Next, starting at the left and proceeding right, the dashes will disappear, after which the display will show: $CR_L 3=$.

CAL 3= – Last Calibration Weight

1. The display will show *CAL 3=*. This weight is not used.
2. Press the **UNITS/◀** key to skip *CAL 3=* and advance to *SEt9C?* prompt.

4.6.2 Dual-Point without Zero (False Zero) Calibration

This calibration method requires one test weight and establishes a new conversion factor only. It is used to establish a false (temporary zero) zero without affecting the zero calibration value stored during the last calibration. This is particularly useful in tank weighing applications, where it may be impractical or impossible to completely empty the tank. This method uses two calibration points, $[\text{CAL } 1:]$ and $[\text{CAL } 2:]$. The value of the test weight is entered when $[\text{CAL } 1:]$ is displayed and the **NET/GROSS** key is pressed when $[\text{CAL } 2:]$ is displayed.

$[\text{CAL } 1:]$ – First Calibration Weight

1. The display will show $[\text{CAL } 1:]$. This is the first of two calibration weights. This weight could be ZERO (NO LOAD) or the TEST WEIGHTS (TEST LOAD).
2. Press the **TARE** \leftarrow key to view the current setting.
3. If the first calibration weight is to be ZERO (NO LOAD), press the **TARE** \leftarrow key.
4. If the first calibration weight is to be the TEST WEIGHTS (TEST LOAD), use the **UNITS**/ \blacktriangleleft and **Fn**/ \blacktriangleright keys to input the value of the test weights.
5. Place the weights on the scale platform, then press the **TARE** \leftarrow key.
6. Starting at the left and proceeding right, a series of dashes will appear on the display.
7. Next, starting at the left and proceeding right, the dashes will disappear, after which the display will show: $[\text{CAL } 2:]$.

$[\text{CAL } 2:]$ – Second Calibration Weight

1. The display will show $[\text{CAL } 2:]$. This is the second of two calibration steps.
2. Remove the weights on the scale platform.
3. Press the **NET/GROSS** key.
4. Starting at the left and proceeding right, a series of dashes will appear on the display.
5. Next, starting at the left and proceeding right, the dashes will disappear, after which the display will show: $5\text{E}69\text{C}2$.

4.6.3 Single-Point for Span Only (Last Zero) Calibration

This calibration method requires one test weight and establishes a new conversion factor (span) without affecting the zero calibration value stored during the last calibration. This minimizes placing and removing test weights and is especially useful when checking high capacity scales. This method uses two calibration points, $[\text{CAL } 1:]$ and $[\text{CAL } 2:]$. The value of the test weight is entered when $[\text{CAL } 1:]$ is displayed and the **ZERO** key is pressed when $[\text{CAL } 2:]$ is displayed.

$[\text{CAL } 1:]$ – First Calibration Weight

1. The display will show $[\text{CAL } 1:]$. This is the first of two calibration steps. This weight is the TEST WEIGHTS (TEST LOAD).
2. Press the **ZERO** key.
3. The display will show: $[\text{CAL } 2:]$.

$[\text{CAL } 2:]$ – Second Calibration Weight

1. Place the weights on the scale platform.
2. Using the **UNITS/◀** and **Fn/▲** keys, input the value of the test weights.
3. Press the **TARE ↵** key.
4. Starting at the left and proceeding right, a series of dashes will appear on the display.
5. Next, starting at the left and proceeding right, the dashes will disappear, after which the display will show: $5\text{E}69\text{E}2$.

4.6.4 Single-Point for Zero Only (Only Zero) Calibration

This calibration method requires no test weight, an empty scale and establishes a new zero without affecting the conversion factor (span). This is useful to regain the full range of zero limit when the dead load of the scale has changed. This would occur for example, if a guard rail has been added to the scale platform. This method uses two calibration points, $[\text{RL } 1=$ and $[\text{RL } 2=$. The **TARE** \leftarrow key is pressed when $[\text{RL } 1=$ is displayed and the **ZERO** key is pressed when $[\text{RL } 2=$ is displayed.

$[\text{RL } 1=$ – First Calibration Weight

1. The display will show $[\text{RL } 1=$. This is the first of two calibration steps.
2. Insure the scale is empty.
3. Press the **TARE** \leftarrow key.
4. Press the **TARE** \leftarrow key.
5. Starting at the left and proceeding right, a series of dashes will appear on the display.
6. Next, starting at the left and proceeding right, the dashes will disappear, after which the display will show: $[\text{RL } 2=$.

$[\text{RL } 2=$ – Second Calibration Weight

1. The display will show $[\text{RL } 2=$. This is the second of two calibration steps.
2. Press the **ZERO** key.
3. The display will advance to $SEt9C?$.

4.6.5 Multi-Point Calibration

This method requires up to four weights, an empty scale and has up to four conversion factors. This method uses up to five calibration points (*CAL 1=*, *CAL 2=*, *CAL 3=*, *CAL 4=*, and *CAL 5=*). The five points correspond to zero weight, up to three mid point weights, and the test load or test weight and can be applied in any order. This method can be used to correct for system nonlinearity.

CAL 1= – First Calibration Weight

1. The display will show *CAL 1=*. This is the first of five calibration weights. This weight could be ZERO (NO LOAD) or the TEST WEIGHTS (TEST LOAD).
2. Press the **TARE** \leftarrow key to view the current setting.
3. If the first calibration weight is to be ZERO (NO LOAD), press the **TARE** \leftarrow key.
4. If the first calibration weight is to be the TEST WEIGHTS (TEST LOAD), use the **UNITS/◀** and **Fn/▲** keys to input the value of the test weights.
5. Place the weights on the scale platform, then press the **TARE** \leftarrow key.
6. Starting at the left and proceeding right, a series of dashes will appear on the display.
7. Next, starting at the left and proceeding right, the dashes will disappear, after which the display will show: *CAL 2=*.

CAL 2= – Second Calibration Weight

1. The display will show *CAL 2=*. This is the second of two calibration weights. This weight could be ZERO (NO LOAD) or the TEST WEIGHTS (TEST LOAD).
2. Press the **TARE** \leftarrow key to view the current setting.
3. If the second calibration weight is to be ZERO (NO LOAD), press the **TARE** \leftarrow key.
4. If the first calibration weight is to be the TEST WEIGHTS (TEST LOAD), use the **UNITS/◀** and **Fn/▲** keys to input the value of the test weights.
5. Place the weights on the scale platform, then press the **TARE** \leftarrow key.
6. Starting at the left and proceeding right, a series of dashes will appear on the display.
7. Next, starting at the left and proceeding right, the dashes will disappear, after which the display will show: *CAL 3=*.

CAL 3: – Third Calibration Weight

1. The display will show **CAL 3:**. This is the second of two calibration weights. This weight could be ZERO (NO LOAD) or the TEST WEIGHTS (TEST LOAD).
2. Press the **TARE** \leftarrow key to view the current setting.
3. If the second calibration weight is to be ZERO (NO LOAD), press the **TARE** \leftarrow key.
4. If the first calibration weight is to be the TEST WEIGHTS (TEST LOAD), use the **UNITS/◀** and **Fn/▲** keys to input the value of the test weights.
5. Place the weights on scale platform, then press **TARE** \leftarrow key.
6. Starting at the left and proceeding right, a series of dashes will appear on the display.
7. Next, starting at the left and proceeding right, the dashes will disappear, after which the display will show: **CAL 4:**.

CAL 4: – Fourth Calibration Weight

1. The display will show **CAL 4:**. This is the fourth of the calibration weights. This weight could be ZERO (NO LOAD) or the TEST WEIGHTS (TEST LOAD). If the fourth calibration weight is not going to be used, press the **UNITS/◀** key to skip **CAL 4:** and advance to **SETEG?** prompt. Otherwise, proceed to the next step.
2. Press the **TARE** \leftarrow key to view the current setting.
3. If the fourth calibration weight is to be ZERO (NO LOAD), press the **TARE** \leftarrow key.
4. If the fourth calibration weight is to be the TEST WEIGHTS (TEST LOAD), use the **UNITS/◀** and **Fn/▲** keys to input the value of the test weights.
5. Place the weights on scale platform, then press **TARE** \leftarrow key.
6. Starting at the left and proceeding right, a series of dashes will appear on the display.
7. Next, starting at the left and proceeding right, the dashes will disappear, after which the display will show: **CAL 5:**.

CAL5: – Last Calibration Weight

1. The display will show **CAL5:**. This is the fifth of the calibration weights. This weight could be ZERO (NO LOAD) or the TEST WEIGHTS (TEST LOAD). If the fifth calibration weight is not going to be used, press the **UNITS/◀** key to skip **CAL5:** and advance to **SETGCP** prompt. Otherwise, proceed to the next step.
2. Press the **TARE ↵** key to view the current setting.
3. If the fifth calibration weight is to be ZERO (NO LOAD), press the **TARE ↵** key.
4. If the fifth calibration weight is to be the TEST WEIGHTS (TEST LOAD), use the **UNITS/◀** and **Fn/▲** keys to input the value of the test weights.
5. Place the weights on the scale platform, then press the **TARE ↵** key.
6. Starting at the left and proceeding right, a series of dashes will appear on the display.
7. Next, starting at the left and proceeding right, the dashes will disappear, after which the display will show: **SETGCP**.

4.6.6 Calibration “[” Numbers



IMPORTANT! If any components have been changed that affect calibration and/or your scale is used in a commercial application and must be "Legal for Trade" you cannot use the “[” numbers to re-calibrate.

The “[” numbers are displayed only during the Test mode operation by pressing the **Fn/▲** key then the **UNITS/◀** key. The “[” numbers are shown at the end of the test operation and each number is displayed for approximately 4 seconds, allowing you to record them. Each number may be up to three (3) digits in length. By recording these numbers you will be able to return the indicator to its present calibration settings without using test weights simply by entering the “[” numbers.

1. With $CAL 1$ displayed, press **UNITS/◀** key.
2. At $[1$ prompt, press **TARE ↵** key to show current value of $[1$ number.
3. If $[1$ value displayed is acceptable, press **TARE ↵** key again to save it.
4. Otherwise, use **Fn/▲** and **UNITS/◀** keys to enter a new $[1$ value and then press the **TARE ↵** key.
5. At $[2$ prompt, press **TARE ↵** key to show current value of $[2$ number.
6. If $[2$ value displayed is acceptable, press **TARE ↵** key again to save it.
7. Otherwise, use **Fn/▲** and **UNITS/◀** keys to enter a new $[2$ value and then press the **TARE ↵** key.
8. At $[3$ prompt, press **TARE ↵** key to show current value of $[3$ number.
9. If $[3$ value displayed is acceptable, press **TARE ↵** key again to save it.
10. Otherwise, use **Fn/▲** and **UNITS/◀** keys to enter a new $[3$ value and then press **TARE ↵** key.
11. At $[4$ prompt, press the **TARE ↵** key to show current value of $[4$ number.
12. If $[4$ value displayed is acceptable, press the **TARE ↵** key again to save it.
13. Otherwise, use **Fn/▲** and **UNITS/◀** keys to enter a new $[4$ value and then press **TARE ↵** key.
14. The display will change to show: $5E-9[2$.

4.7 Set Gravity Constant

The Cardinal 190 Weight Indicator is equipped with an acceleration of gravity function which means that it can be calibrated in one location and then adjusted to match the acceleration of gravity at the location where it will be used.

SEt9C

With SEt9C displayed, press the **TARE** \leftarrow key. The display will change to CAL9C=. Proceed to the CAL9C= parameter.

SEt9C?

With SEt9C? displayed, press the **TARE** \leftarrow key. The display will change to no. Press the **Fn/▲** key to toggle to YES and then press the **TARE** \leftarrow key. The display will change to CAL9C=. Proceed to the CAL9C= parameter. Otherwise, to skip the Set Gravity Constant setup, press the **TARE** \leftarrow key to advance to the S i o ? . prompt.

CAL9C= (Calibrated Gravity Constant)

This is the acceleration of gravity value of the location where the scale was calibrated. Set to 0 if calibrated at location of operation or if gravity constants are not going to be used.

Press the **TARE** \leftarrow key to show the current setting. If the value displayed is acceptable, press the **TARE** \leftarrow key to save it. Otherwise, use the **Fn/▲** and **UNITS/◀** keys to enter a new value and press the **TARE** \leftarrow key to save it.

oP9C= (Operating Gravity Constant)

This is the acceleration of gravity value for the location where the scale will be operated.

Press the **TARE** \leftarrow key to show the current setting. If the value displayed is acceptable, press the **TARE** \leftarrow key to save it. Otherwise, use the **Fn/▲** and **UNITS/◀** keys to enter a new value and press the **TARE** \leftarrow key to save it. Consult the factory Tech Support for the Acceleration of Gravity value for your location.

4.8 Serial Input/Output

S io

With *S io* displayed, press the **TARE** \leftarrow key. The display will change to *bAud:*. Proceed to the *bAud:* parameter.

S io?

With *S io?* displayed, press the **TARE** \leftarrow key. The display will change to *no*. Press the **Fn/▲** key to toggle to *YES* and then press the **TARE** \leftarrow key. The display will change to *bAud:*. Proceed to the *bAud:* parameter. Otherwise, to skip Serial Input/Output setup, press the **TARE** \leftarrow key to advance to the *Prnt?* prompt.

bAud: (Serial Interface Baud Rate)

Press the **TARE** \leftarrow key to show the current setting. If the setting displayed is acceptable, press the **TARE** \leftarrow key again to save it. Otherwise, use the **Fn/▲** key to toggle to a new baud rate for the serial ports and then press the **TARE** \leftarrow key to save it. Allowable settings are:

12 = 1200 Baud	24 = 2400 Baud	48 = 4800 Baud
96 = 9600 Baud	19 = 19200k Baud	38 = 38400 Baud
76 = 76800 Baud		

Prnt? (Serial Interface Parity Setting)

Press the **TARE** \leftarrow key to show the current setting. If the setting displayed is acceptable, press the **TARE** \leftarrow key again to save it. Otherwise, use the **Fn/▲** key to toggle to a new setting and then press the **TARE** \leftarrow key to save it.

Allowable settings are:

- 0 = No Parity with 8 data bits
- 1 = Odd Parity with 7 data bits
- 2 = Even Parity with 7 data bits

Cont I: (Continuous Output on Serial Interface)

Press the **TARE** \leftarrow key to show the current setting. If the setting displayed is acceptable, press the **TARE** \leftarrow key again to save it. Otherwise, use the **Fn/▲** key to toggle to a new setting and then press the **TARE** \leftarrow key to save it.

- YES = Continuous Output on Serial Interface
- no = No Continuous Output on Serial Interface

If **Cont I: YES** (Continuous Output) is selected, an additional prompt, **TYPE:** will be displayed.

If **Cont I: no** (No Continuous Output) is selected, proceed to the Weight On Demand section. (See Paragraph 4.8.3)

TYPE: (Continuous Output Format)

Press the **TARE** \leftarrow key to show the current setting. If the setting displayed is acceptable, press the **TARE** \leftarrow key again to save it. Otherwise, use the **Fn/▲** key to toggle to a new setting and then press the **TARE** \leftarrow key to save it. Allowable settings are:

- 0 = Continuous Output uses SMA format
- 1 = Continuous Output uses Cardinal Scoreboard format

4.8.1 SMA Continuous Output Format

If SMA is selected, data will be transmitted in the following format:

`<lf><s><r><n><m><f><xxxxxx.xxx><uuu><cr>`

Where:

- lf = Line Feed
- s = Flags Z= center of Zero, O = Overcap, E = zero Error, e = weight not currently being displayed
- r = Range 1
- n = Mode G = Gross, T = Tare, N = Net
- m = Motion M = Motion, " "(blank) = no motion
- f = Custom Custom flag
- xxxxxx.xxx = Weight Ten characters including decimal point (if any)
- uuu = Units lb, oz, kg, g
- cr = Carriage (hex 0D) Return

4.8.2 Cardinal Scoreboard Continuous Output Format

If Cardinal Scoreboard is selected, the data will be transmitted in the following format:

```
<s><xxxxxx><d><uu><m><cc><cr>
```

Where:

s =	Sign	"-" = negative, " " (<i>blank</i>) = positive
xxxxxx =	Weight	Six digits
d =	Decimal point	Added to string if enabled in setup
uu =	Units	LB, OZ, KG, G
m =	Mode	G = Gross, N = Net
cc =	Weight Status	OC = overcap CZ = center of zero MO = motion EE = weight not currently being displayed
cr =	Carriage Return	(hex 0D)

4.8.3 Weight On Demand

If continuous output has not been selected for Serial Port 1 (Cont1=NO), the 190 indicator will respond to a weight request (ENQ).

The host device (computer) sends:

ENQ - (hex 05)

The 190 will respond:

```
<s><xxxxxx><d><uu><m><cc><cr>
```

Where:

s =	Sign	"-" = negative, " " (<i>blank</i>) = positive
xxxxxx =	Weight	Six digits
d =	Decimal point	Added to string if enabled in setup
uu =	Units	LB, OZ, KG, G
m =	Mode	G = Gross, N = Net
cc =	Weight Status	OC = overcap CZ = center of zero MO = motion EE = weight not currently being displayed
cr =	Carriage Return	(hex 0D)

4.9 Print Tab Settings

Print

With *Print* displayed, press the **TARE** \leftarrow key. The display will change to *Port=*. Proceed to the *Port=* parameter.

Print?

With *Print?* displayed, press the **TARE** \leftarrow key. The display will change to *no*. Press the **Fn/▲** key to toggle to *YES* and then press the **TARE** \leftarrow key. The display will change to *Port=*. Proceed to the *Port=* parameter.

Otherwise, to skip the Print Tab Settings setup, press the **TARE** \leftarrow key to advance to the *FSPRN?* prompt.

The general format for the input is A = YY.XX where A is the character identifying the data printed, YY is the number of lines down and XX is the number of columns to the right.



NOTE! Enter 00 in either the YY or XX location to disable the data from printing.

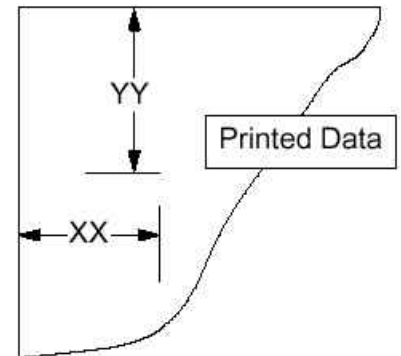

Port= (Select Serial Interface for Printing)

Press the **TARE** \leftarrow key to show the current setting. If the setting displayed is acceptable, press the **TARE** \leftarrow key again to save it. Otherwise, use the **Fn/▲** key to toggle to a new setting and then press the **TARE** \leftarrow key to save it. Allowable values are:

- 0 = Ticket Printing Disabled
- 1 = Standard Serial Interface used for Printing
- 2 = Optional Serial Interface used for Printing
(Serial Option Card must be installed)

Hour = (Time Print Location)

Press the **TARE** \leftarrow key to show the current setting for the Time Print Location. If the setting displayed is acceptable, press the **TARE** \leftarrow key again to save it. Otherwise, use the **Fn/▲** and **UNITS/◀** keys to enter a new location and then press the **TARE** \leftarrow key to save it.

date = (Date Print Location)

Press the **TARE** \leftarrow key to show the current setting for the Date Print Location. If the setting displayed is acceptable, press the **TARE** \leftarrow key again to save it. Otherwise, use the **Fn/▲** and **UNITS/◀** keys to enter a new location and then press the **TARE** \leftarrow key to save it.

gross = (Gross Weight Print Location)

Press the **TARE** \leftarrow key to show the current setting for the Gross Weight Print Location. If the setting displayed is acceptable, press the **TARE** \leftarrow key again to save it. Otherwise, use the **Fn/▲** and **UNITS/◀** keys to enter a new location and then press the **TARE** \leftarrow key to save it.

tare = (Tare Weight Print Location)

Press the **TARE** \leftarrow key to show the current setting for the Tare Weight Print Location. If the setting displayed is acceptable, press the **TARE** \leftarrow key again to save it. Otherwise, use the **Fn/▲** and **UNITS/◀** keys to enter a new location and then press the **TARE** \leftarrow key to save it.

net = (Net Weight Print Location)

Press the **TARE** \leftarrow key to show the current setting for the Net Weight Print Location. If the setting displayed is acceptable, press the **TARE** \leftarrow key again to save it. Otherwise, use the **Fn/▲** and **UNITS/◀** keys to enter a new location and then press the **TARE** \leftarrow key to save it.

9 RLL : (Gross Weight Accumulator Print Location)

Press the **TARE** ↵ key to show the current setting for the Gross Weight Accumulator Print Location. If the setting displayed is acceptable, press the **TARE** ↵ key again to save it. Otherwise, use the **Fn/▲** and **UNITS/◀** keys to enter a new location and then press the **TARE** ↵ key to save it.

n RLL : (Net Weight Accumulator Print Location)

Press the **TARE** ↵ key to show the current setting for the Net Weight Accumulator Print Location. If the setting displayed is acceptable, press the **TARE** ↵ key again to save it. Otherwise, use the **Fn/▲** and **UNITS/◀** keys to enter a new location and then press the **TARE** ↵ key to save it.

Count : (Count "number of pieces on the scale" Print Location)

Press the **TARE** ↵ key to show the current setting for the Count Print Location. If the setting displayed is acceptable, press the **TARE** ↵ key again to save it. Otherwise, use the **Fn/▲** and **UNITS/◀** keys to enter a new location and then press the **TARE** ↵ key to save it.

ERCH : (Piece Weight Print Location)

Press the **TARE** ↵ key to show the current setting for the Piece Weight Print Location. If the setting displayed is acceptable, press the **TARE** ↵ key again to save it. Otherwise, use the **Fn/▲** and **UNITS/◀** keys to enter a new location and then press the **TARE** ↵ key to save it.

CrLF : (Carriage Return Line Feed) - Data Format Termination

Data transmitted from the serial I/O port can be terminated with a single carriage return and either no line feed or a single line feed command. Press the **TARE** ↵ key to view the current setting. A **CR LF** on the display means the data will be terminated with a carriage return AND a line feed while a **CR** on the display means the data will be terminated with a single carriage return only.

If the setting displayed is acceptable, press the **TARE** ↵ key again to save it. Otherwise, use the **Fn/▲** key to toggle to a new setting and then press the **TARE** ↵ key to save it.

***EOP* = (End-Of-Print Line Feeds)**

At the end of a data transmission to a printer, the indicator can transmit a pre-selected number of line feed commands to space the paper in the printer to the desired position for withdrawal or for the next print.

Press the **TARE** ↵ key to show the current setting for the End Of Print Line Feeds. If the setting displayed is acceptable, press the **TARE** ↵ key again to save it.

Otherwise, use the **Fn/▲** and **UNITS/◀** keys to enter a new number of End-Of-Print linefeeds and then press the **TARE** ↵ key to save it. Allowable settings are: 0 through 99

4.10 Fine Span Adjustment



IMPORTANT! The *FSPAN* (*FSPAN?*) mode requires a load of 10% of Capacity on the scale before adjustments can be made.

FSPAN

Fine Span Adjustment (from *SETUP* Prompt)

1. If Fine Span Adjustment is desired, with the *SETUP* prompt displayed, press the **UNITS/◀** key until the display shows the *FSPAN* prompt.
2. Place a calibrated test weight on the scale and press the **TARE ↵** key.
3. The display will change to show the amount of the test weight, an *F* will be displayed to the right of the annunciators and the annunciators will alternately flash off and on.
4. Press the **Fn/▲** key to increase the span by 0.5 division OR press the **UNITS/◀** key to decrease the span by 0.5 division.
5. Press the **TARE ↵** key to exit the Fine Span Adjustment and advance to the *HIRESP* prompt.

FSPAN?

Fine Span Adjustment (after pressing **TARE ↵** at last *Prompt* prompt)

1. With *FSPAN?* displayed, press the **TARE ↵** key.
2. The display will change to *no*.
3. Place a calibrated test weight on the scale.
4. Press the **Fn/▲** key to toggle to *YES* and then press the **TARE ↵** key.
5. The display will change to show the amount of the test weight, an *F* will be displayed to the right of the annunciators and the annunciators will alternately flash off and on.
6. Press the **Fn/▲** key to increase the span by 0.5 division OR press the **UNITS/◀** key to decrease the span by 0.5 division.
7. Press the **TARE ↵** key to exit the Fine Span Adjustment and advance to the *HIRESP* prompt.

4.11 Display High Resolution Weight



IMPORTANT! The *H i r E S* (*H i r E S P*) mode requires a load of **10% of Capacity** on the scale.

H i r E S

High Resolution Weight (from *S E T U P* Prompt)

1. If displaying High Resolution Weight is desired, with the *S E T U P* prompt displayed, press **UNITS/◀** key until the display shows the *H i r E S* prompt.
2. Place a calibrated test weight on the scale and press the **TARE ↵** key.
3. The display will change to show the amount of the test weight in "high resolution" mode (1/10 division), an *h* will be displayed to the right of the annunciators and the annunciators will alternately flash off and on.
4. Press the **Fn/▲** key to increase the span by 0.1 division *OR* press the **UNITS/◀** key to decrease the span by 0.1 division.
5. Press the **TARE ↵** key to exit the Display High Resolution Weight and advance to *L o C o U E P* prompt.

H i r E S P

High Resolution Weight (after **TARE ↵** pressed at *F S P A n* prompt)

1. With *H i r E S P* displayed, press the **TARE ↵** key.
2. The display will change to *n o*.
3. Place a calibrated test weight on the scale.
4. Press the **Fn/▲** key to toggle to *g E S* and then press the **TARE ↵** key.
5. The display will change to show the amount of the test weight in "high resolution" mode (1/10 division), an *h* will be displayed to the right of the annunciators and the annunciators will alternately flash off and on.
6. Press the **Fn/▲** key to increase the span by 0.1 division *OR* press the **UNITS/◀** key to decrease the span by 0.1 division.
7. Press the **TARE ↵** key to exit the Display High Resolution Weight and advance to the *L o C o U E P* prompt.

4.12 Key Lockout Feature

The Key Lockout Feature allows keys on the indicator to be disabled for use by the operator “*during normal operation*”. During normal operation, when the operator presses a locked key, the display will show `LoCd` for about a 1/2 second and the key will be ignored.



NOTE! The Key Lockout Feature only disables keys for use during normal operation, not setup and calibration.

`LoCoUt`

With `LoCoUt` displayed, press the **TARE** \leftarrow key. The display will change to show `ZErOz`. Proceed to the `ZErOz` parameter.

`LoCoUt?`

With `LoCoUt?` displayed, press the **TARE** \leftarrow key. The display will change to `no`. Press the **Fn/▲** key to toggle to `YES` and then press the **TARE** \leftarrow key. The display will change to `ZErOz`. Proceed to the `ZErOz` parameter. Otherwise, to skip the Key Lockout Feature setup, press the **TARE** \leftarrow key to advance to the `oPte?` prompt.

`ZErOz` (ZERO Key)

Press the **TARE** \leftarrow key to show the current setting. If the setting displayed is acceptable, press the **TARE** \leftarrow key again to save it. Otherwise, use the **Fn/▲** key to toggle to a new setting and then press the **TARE** \leftarrow key to save it.

`UnLoCd`

Key is Unlocked (Enabled)

`LoCd`

Key is Locked (Disabled)

`tArEz` (TARE \leftarrow Key)

Press the **TARE** \leftarrow key to show the current setting. If the setting displayed is acceptable, press the **TARE** \leftarrow key again to save it. Otherwise, use the **Fn/▲** key to toggle to a new setting and then press the **TARE** \leftarrow key to save it.

`UnLoCd`

Key is Unlocked (Enabled)

`LoCd`

Key is Locked (Disabled)

Net = (NET/GROSS Key)

Press the **TARE** ↵ key to show the current setting. If the setting displayed is acceptable, press the **TARE** ↵ key again to save it. Otherwise, use the **Fn/▲** key to toggle to a new setting and then press the **TARE** ↵ key to save it.

<i>UnLoCd</i>	<i>LoCd</i>
Key is Unlocked (Enabled)	Key is Locked (Disabled)

Units = (UNITS/◀ Key)

Press the **TARE** ↵ key to show the current setting. If the setting displayed is acceptable, press the **TARE** ↵ key again to save it. Otherwise, use the **Fn/▲** key to toggle to a new setting and then press the **TARE** ↵ key to save it.

<i>UnLoCd</i>	<i>LoCd</i>
Key is Unlocked (Enabled)	Key is Locked (Disabled)

Func = (Fn/▲ Key)

Press the **TARE** ↵ key to show the current setting. If the setting displayed is acceptable, press the **TARE** ↵ key again to save it. Otherwise, use the **Fn/▲** key to toggle to a new setting and then press the **TARE** ↵ key to save it.

<i>UnLoCd</i>	<i>LoCd</i>
Key is Unlocked (Enabled)	Key is Locked (Disabled)

Print = (PRINT Key)

Press the **TARE** ↵ key to show the current setting. If the setting displayed is acceptable, press the **TARE** ↵ key again to save it. Otherwise, use the **Fn/▲** key to toggle to a new setting and then press the **TARE** ↵ key to save it.

<i>UnLoCd</i>	<i>LoCd</i>
Key is Unlocked (Enabled)	Key is Locked (Disabled)

ON (ON/OFF Key)

Press the **TARE** ↵ key to show the current setting. If the setting displayed is acceptable, press the **TARE** ↵ key again to save it. Otherwise, use the **Fn/▲** key to toggle to a new setting and then press the **TARE** ↵ key to save it.

UnLoCk

Key is Unlocked (Enabled)

LoCk

Key is Locked (Disabled)



IMPORTANT! When the **ON/OFF** key is locked, the display will briefly show "*LoCk*" and then prompt the operator to press the following keys in this order:

PRINT,**ZERO,****Fn/▲,****TARE** ↵,**UNITS/◀,****NET/GROSS**

If no key is pressed or the keys are pressed in the wrong order, the indicator will turn back off.

4.13 Options Setup

oPt ion

With *oPt* displayed, press the **TARE** \leftarrow key. The display will change to show *oPt =*. Proceed to the *oPt =* parameter.

oPt ?

With *oPt ?* displayed, press the **TARE** \leftarrow key. The display will change to *no*. Press the **Fn/▲** key to toggle to *YES* and then press the **TARE** \leftarrow key. The display will change to *oPt =*. Proceed to the *oPt =* parameter. Otherwise, to skip the Options Setup, press the **TARE** \leftarrow key to advance to the *Func ?* prompt.

oPt = (Option)

Press the **TARE** \leftarrow key to show the current setting. If the setting displayed is acceptable, press the **TARE** \leftarrow key again to save it. Otherwise, use the **Fn/▲** key to toggle to a new setting and then press the **TARE** \leftarrow key to save it. Allowable values are:

- 0 = No Option Card Installed
- 1 = Serial Interface Option Card Installed
- 2 = Field Bus Option Card Installed



IMPORTANT! The settings for the following prompts, *baud =*, *Prty =*, and *Cont ?* are only applied when the *oPt =* parameter is set to 0 or 1.

baud = (Optional Serial Interface Baud Rate)

Press the **TARE** \leftarrow key to show the current setting. If the setting displayed is acceptable, press the **TARE** \leftarrow key again to save it. Otherwise, use the **Fn/▲** key to toggle to a new baud rate for the serial ports and then press the **TARE** \leftarrow key to save it. Allowable settings are:

- | | | |
|-----------------|-----------------|-----------------|
| 12 = 1200 Baud | 24 = 2400 Baud | 48 = 4800 Baud |
| 96 = 9600 Baud | 19 = 19.2k Baud | 38 = 38.4k Baud |
| 76 = 76.8k Baud | | |

Prty: (Optional Serial Interface Parity Setting)

Press the **TARE** \leftarrow key to show the current setting. If the setting displayed is acceptable, press the **TARE** \leftarrow key again to save it. Otherwise, use the **Fn/▲** key to toggle to a new setting and then press the **TARE** \leftarrow key to save it. Allowable settings are:

- 0 = No Parity with 8 data bits
- 1 = Odd Parity with 7 data bits
- 2 = Even Parity with 7 data bits

Cont: (Continuous Output on Optional Serial Interface)

Press the **TARE** \leftarrow key to show the current setting. If the setting displayed is acceptable, press the **TARE** \leftarrow key again to save it. Otherwise, use the **Fn/▲** key to toggle to a new setting and then press the **TARE** \leftarrow key to save it.

- YES = Continuous Output on Optional Serial Interface
- NO = No Continuous Output on Optional Serial Interface



IMPORTANT! The setting for the *TYPE:* are only applied when the *Cont:* parameter is set to 1 and *Cont:* parameter is set to YES.

TYPE: (Continuous Output Format)

Press the **TARE** \leftarrow key to show the current setting. If the setting displayed is acceptable, press the **TARE** \leftarrow key again to save it. Otherwise, use the **Fn/▲** key to toggle to a new setting and then press the **TARE** \leftarrow key to save it. Allowable settings are:

- 0 = Continuous Output uses SMA format
- 1 = Continuous Output uses Cardinal Scoreboard format

NOTE! Refer to the *Cont 1:* Continuous Output on Serial Interface, *TYPE:* parameter for description of output formats.



IMPORTANT! The following prompts, *bAud:* and *Addr:* are only displayed when the *opt:* parameter is set to 2.

***bAud:* (Field Bus Option Baud Rate)**

Press the **TARE** \leftarrow key to show the current setting. If the setting displayed is acceptable, press the **TARE** \leftarrow key again to save it. Otherwise, use the **Fn/▲** key to toggle to a new baud rate for the serial ports and then press the **TARE** \leftarrow key to save it. Allowable settings are:

0 = 125k

1 = 250k

3 = 500k

***Addr:* (Field Bus Option MAC Address)**

Press the **TARE** \leftarrow key to show the current setting. If the setting displayed is acceptable, press the **TARE** \leftarrow key again to save it. Otherwise, use the **Fn/▲** key to toggle to a new setting and then press the **TARE** \leftarrow key to save it. Allowable settings are: 0 through 63

4.14 Function Setup

FUnC

With *FUnC* displayed, press the **TARE** ↵ key. The display will change to show *Hold=*. Proceed to the *Hold=* parameter.

FUnCP

With *FUnCP* displayed, press the **TARE** ↵ key. The display will change to *no*. Press the **Fn/▲** key to toggle to *YES* and then press the **TARE** ↵ key. The display will change to *Hold=*. Proceed to the *Hold=* parameter. Otherwise, to skip the Options Setup, press the **TARE** ↵ key to advance to the *CoLoRS* prompt.



IMPORTANT! The Hold, Count and Live Weight Features should not be enabled if the Legal-For-Trade option (*Lft=YES*) was selected during setup.

In addition, only one of the features Hold, Count, Peak Hold, Checkweigher or Live Weight can be enabled at a time.

HoLd= (Hold Function)

Press the **TARE** ↵ key to show the current setting. If the setting displayed is acceptable, press the **TARE** ↵ key again to save it. Otherwise, use the **Fn/▲** key to toggle to a new setting and then press the **TARE** ↵ key to save it. Allowable values are:

YES

Hold Function is Enabled

no

Hold Function is Disabled

CoUnt= (Count Function)

Press the **TARE** ↵ key to show the current setting. If the setting displayed is acceptable, press the **TARE** ↵ key again to save it. Otherwise, use the **Fn/▲** key to toggle to a new setting and then press the **TARE** ↵ key to save it. Allowable values are:

YES

Count Function is Enabled

no

Count Function is Disabled

Time and Date

Press the **TARE** \leftarrow key to show the current setting. If the setting displayed is acceptable, press the **TARE** \leftarrow key again to save it. Otherwise, use the **Fn/▲** key to toggle to a new setting and then press the **TARE** \leftarrow key to save it. Allowable values are:

YES Time and Date is Enabled	NO Time and Date is Disabled
--	--

Peak Hold Function

Press the **TARE** \leftarrow key to show the current setting. If the setting displayed is acceptable, press the **TARE** \leftarrow key again to save it. Otherwise, use the **Fn/▲** key to toggle to a new setting and then press the **TARE** \leftarrow key to save it. Allowable values are:

YES Peak Hold Function is Enabled	NO Peak Hold Function is Disabled
---	---

Checkweigher Function

Press the **TARE** \leftarrow key to show the current setting. If the setting displayed is acceptable, press the **TARE** \leftarrow key again to save it. Otherwise, use the **Fn/▲** key to toggle to a new setting and then press the **TARE** \leftarrow key to save it. Allowable values are:

YES Checkweigher Function is Enabled	NO Checkweigher Function is Disabled
--	--

Live Weight Function

Press the **TARE** \leftarrow key to show the current setting. If the setting displayed is acceptable, press the **TARE** \leftarrow key again to save it. Otherwise, use the **Fn/▲** key to toggle to a new setting and then press the **TARE** \leftarrow key to save it. Allowable values are:

YES Live Weight Function is Enabled	NO Live Weight Function is Disabled
---	---

ACCU= (Weight Accumulation Function)

Press the **TARE** \leftarrow key to show the current setting. If the setting displayed is acceptable, press the **TARE** \leftarrow key again to save it. Otherwise, use the **Fn/▲** key to toggle to a new setting and then press the **TARE** \leftarrow key to save it. Allowable values are:

YES

Weight Accumulation
Function is Enabled

NO

Weight Accumulation
Function is Disabled

4.15 Display Backlight Color Setup

CoLoR5

With *CoLoR5* displayed, press the **TARE** \leftarrow key. The display will change to show *dFLt=*. Proceed to the *dFLt=* parameter.

CoLoR2

With *CoLoR2* displayed, press the **TARE** \leftarrow key. The display will change to *no*. Press the **Fn/▲** key to toggle to *YES* and then press the **TARE** \leftarrow key. The display will change to *dFLt=*. Proceed to the *dFLt=* parameter.

Otherwise, to skip the Display Backlight Color setup, press the **TARE** \leftarrow key to reset the indicator and return to the normal weight display.

dFLt= (Default Display Backlight Color)

Press the **TARE** \leftarrow key to show the current setting. If the setting displayed is acceptable, press the **TARE** \leftarrow key again to save it. Otherwise, use the **Fn/▲** key to toggle to a new setting and then press the **TARE** \leftarrow key to save it. Allowable settings are:

0 = No Backlight 1 = Red Backlight 2 = Green Backlight
3 = Yellow Backlight 4 = Blue Backlight

UndEr= (Checkweigher “Under” Backlight Color)

Press the **TARE** \leftarrow key to show the current setting. If the setting displayed is acceptable, press the **TARE** \leftarrow key again to save it. Otherwise, use the **Fn/▲** key to toggle to a new setting and then press the **TARE** \leftarrow key to save it. Allowable settings are:

0 = No Backlight 1 = Red Backlight 2 = Green Backlight
3 = Yellow Backlight 4 = Blue Backlight

ACCEPT = (Checkweigher “Accept” Backlight Color)

Press the **TARE** \leftarrow key to show the current setting. If the setting displayed is acceptable, press the **TARE** \leftarrow key again to save it. Otherwise, use the **Fn/▲** key to toggle to a new setting and then press the **TARE** \leftarrow key to save it. Allowable settings are:

0 = No Backlight 1 = Red Backlight 2 = Green Backlight
3 = Yellow Backlight 4 = Blue Backlight

OVER = (Checkweigher “Over” Backlight Color)

Press the **TARE** \leftarrow key to show the current setting. If the setting displayed is acceptable, press the **TARE** \leftarrow key again to save it. Otherwise, use the **Fn/▲** key to toggle to a new setting and then press the **TARE** \leftarrow key to save it. Allowable settings are:

0 = No Backlight 1 = Red Backlight 2 = Green Backlight
3 = Yellow Backlight 4 = Blue Backlight

5. CALIBRATION SEAL

5.1 Installing the Calibration Seal

If your Model 190 Weight Indicator is used in a commercial application it must be tested and sealed by your local weights and measurements official. The 190 is designed to accept a lead and wire security seal to prevent unauthorized access to the calibration adjustments. Refer to Figure No. 9, 10, 11 and 12 for details on the installation of the seal.

Figure No. 9

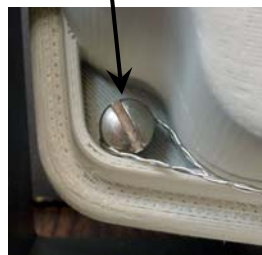
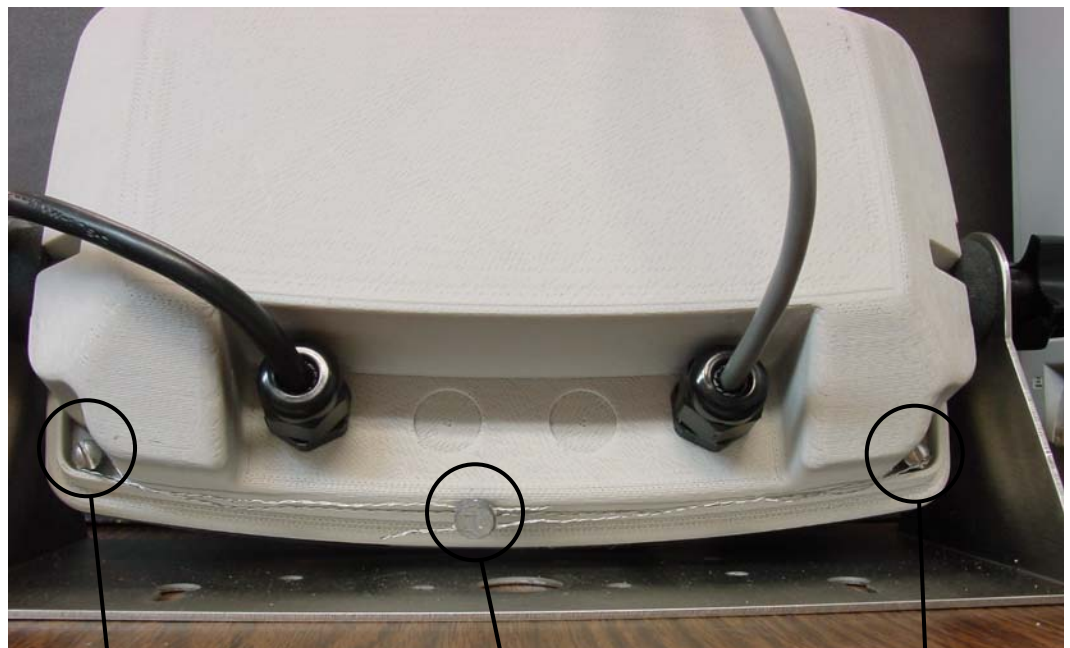

Figure No. 10

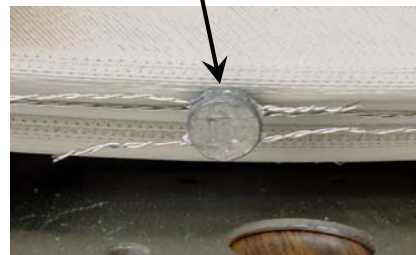

Figure No. 11



Figure No. 12

6. KEYPAD

6.1 Standard Key Functions

The Model 190 is equipped with a 7-key Capacitive Touch keypad. The keypad is used to enter commands and data into the indicator. This section describes each key along with its normal function. It is helpful to refer to the actual indicator while reading this section.



The Model 190 use a capacitive touch keypad that requires a “finger touch” to function. The keypad will not operate with other items such as pen, pencil or tools.

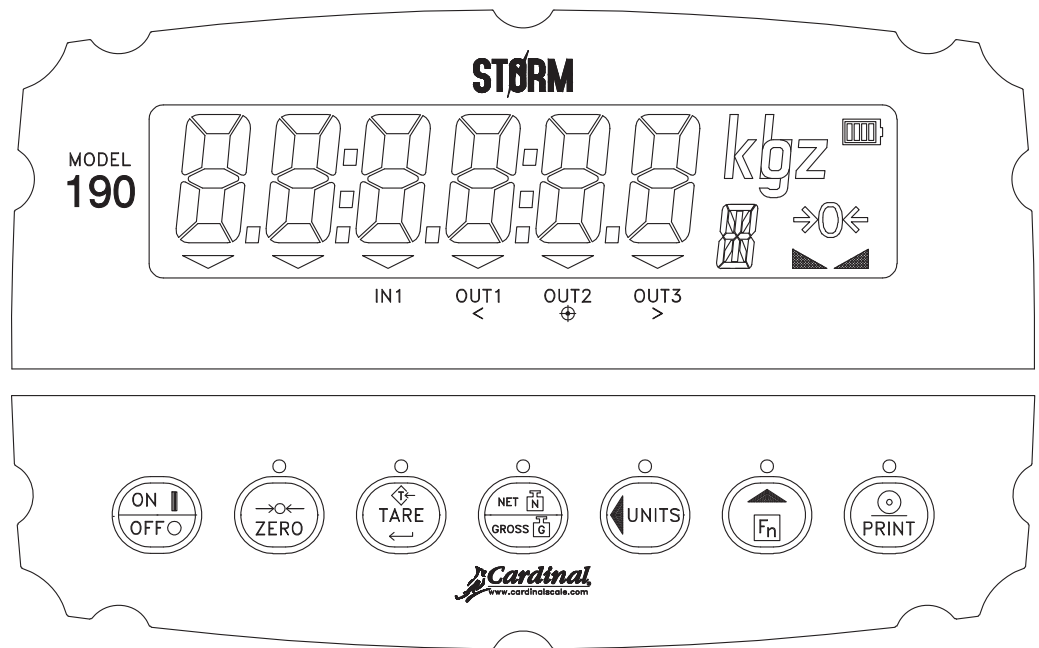



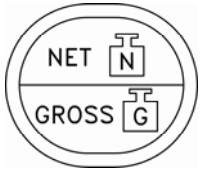





Figure No. 13

Key	Description
	<p>ON/OFF: The ON/OFF key is used to turn the indicator on and off.</p> <ul style="list-style-type: none"> • Press the ON/OFF key when the indicator is off to turn the indicator ON. The 190 will perform a display test (turn on all segments) and then show the model number and software version. • If the indicator is already on, press the ON/OFF key and hold for 2 to 3 seconds. When the display shows <i>OFF</i>, release the key to turn the indicator OFF.
	<p>ZERO: The ZERO key is used to zero the weight display. Up to the selected limit of 4% or 100% of the scale's capacity can be zeroed. This limit is selected during the setup and calibration of the indicator.</p> <p>Note that the indicator will not respond to pressing the ZERO key unless the weight display is stable.</p> <ul style="list-style-type: none"> • When displaying a Tare weight, pressing the ZERO key will clear the Tare value and set the display to Gross mode. • When displaying the Peak weight, pressing the ZERO key will clear the Peak weight. • When displaying the Gross accumulator, pressing the ZERO key will clear the Gross accumulator. • When displaying the Net accumulator, pressing the ZERO key will clear the Net accumulator.

Key	Description
	<p>TARE ↵ (Enter): The TARE ↵ key is used during normal operation to store the current Gross weight as the new Tare weight. The display will change to the Net weight and the Net annunciator will turn on.</p> <ul style="list-style-type: none"> Pressing the TARE ↵ key when in the Net weight mode will cause the display to show the Tare weight. During Setup, pressing the TARE ↵ key will display the current setting of the parameter. Pressing the TARE ↵ key a second time (after changing parameter values or settings), signals completion of the entry of data and causes the indicator to process the data entered.
	<p>NET/GROSS: The NET/GROSS key is used to toggle between the Gross and Net weight modes. The selected mode is indicated by turning on the appropriate annunciator on the display.</p> <p>Note that if no valid tare weight has been entered, pressing the NET/GROSS key will cause a momentary display error (<i>not R-E</i>) and the indicator will remain in the Gross weight mode.</p> <p>When in Hold, Count, Peak weight, Live weight, or Accumulator display mode, press the NET/GROSS key to return the display to normal weight display mode.</p>
	<p>UNITS/← (Left Arrow): The UNITS/← key is used for several functions.</p> <ul style="list-style-type: none"> In normal operation, the UNITS/← key is used to select the units in which the weight is to be displayed. The available units of measure ("unit1" and "unit2") are selected in setup. The available units include pounds, ounces, kilograms, and grams. <p>During setup, the UNITS/← key is used to advance the cursor left to the next position when inputting setup parameters.</p>

Key	Description
	<p>Fn/▲ (Up Arrow): The Fn/▲ key is used for several functions.</p> <ul style="list-style-type: none"> • During indicator setup, when a setup parameter (not a parameter value or setting) is displayed, pressing the Fn/▲ key will "backup" to the previous parameter prompt. • Also during setup, when a parameter value or setting is displayed, pressing the Fn/▲ key will "toggle" between the different available values or settings for that parameter. <p>In normal operation, the Fn/▲ key is used in conjunction with the other keys on the keypad to access additional indicator features.</p>
	<p>PRINT: Pressing the PRINT key during a weighing operation, will add the displayed Gross weight, or Net weight to the associated accumulator and send print ticket data to the serial interface selected during setup (see <i>Port =</i>).</p> <p>NOTE! The indicator will not respond to pressing the PRINT key unless the weight display is stable.</p> <ul style="list-style-type: none"> • If displaying Gross weight, the only weight printed is Gross weight. • If displaying Net weight, the Gross, Tare, and Net weights are printed. • When in Gross weight accumulator display mode, pressing the PRINT key will print the Gross weight accumulator. • When in Net weight accumulator display mode, pressing the PRINT key will print the Net weight accumulator. • When in Peak weight display mode, pressing the PRINT key will print the Peak weight.

6.2 Fn/▲ Key Functions

The **Fn/▲** key is used to select several additional functions that may have been enabled during the setup and calibration of the indicator. Those functions include: Hold, Count, Time and Date, Peak Hold, Checkweigher, Live Weight, Weight Accumulation and Backlight Color.



IMPORTANT! The Hold, Count and Live Weight functions cannot be enabled if the Legal-For-Trade option (*L F t = Y E S*) was selected during setup.

In addition, only one of the functions Hold, Count, Peak Hold, Checkweigher or Live Weight can be enabled at a time.

Description of Fn/▲ Key Functions

Function	Display	Description or Setting
Hold	<i>H o L d</i> X	X will be 1 if enabled, 0 if disabled
Count	<i>C o U n t</i> X	X will be 1 if enabled, 0 if disabled
Time and Date	HH:MM A MM.DD.YY (<i>U S R = Y E S</i>) DD.MM.YY (<i>U S R = n o</i>)	HH=hours, MM=minutes, A for AM, P for PM MM=month, DD=day, YY=last two digits of year
Peak Hold	<i>P h o L d</i> X	X will be 1 if enabled, 0 if disabled
Checkweigher	<i>L o =</i> X*	Minimum acceptable weight prompt = minimum acceptable weight value. * When the value for <i>L o =</i> is greater than 0, the Checkweigher function is enabled.
	<i>H i =</i> X	Maximum acceptable weight prompt. This prompt is displayed, when the value for <i>L o =</i> is greater than 0. = maximum acceptable weight value
Live Weight	<i>R e t</i> X	X will be 1 if enabled, 0 if disabled
Weight Accumulation	<i>A C C U</i> X	X will be 1 if enabled, 0 if disabled
Backlight Color	<i>C o L o r S</i>	Backlight Colors for normal operation and Checkweigher results

6.3 Fn/▲ Key Combination Features

The **Fn/▲** key is also used in combination with the other keys on the keypad to access additional indicator features. Those features and their associated key combinations are as follows:

Fn/▲, ZERO KEY

This combination will enter the Review mode of Setup and Calibration. Refer to the Setup Review section of this manual for details.

Fn/▲, NET/GROSS KEY

This combination will allow viewing of the Audit Trail Counters. Refer to the View Event Counters section of this manual for details.

Fn/▲, UNITS/◀ KEY

This combination will enter the Test Mode/Diagnostics Feature. This feature is used to conduct a test of all display elements and perform self-diagnostics. Refer to the Test/Mode/Diagnostics section of this manual for details.

Fn/▲, PRINT KEY

This key combination is used for several functions. Print formats are selected by using the **Fn/▲** key and **PRINT** keys in combination. Note that when the **PRINT** key is pressed the indicator looks for the selected format. If no visual ticket is found it reverts to the print tab settings. Refer to section 9.2.1 for details on Ticket Format Selection.

This key combination is also used to enter the Preset Weight Comparators "PWC" weight values. Refer to section 9.3 for details on Preset Weight Comparators.

7. ANNUNCIATORS

7.1 Annunciators

The Model 190 is equipped with annunciators that are turned on to indicate that the display is in the mode corresponding to the annunciator label or that the status indicated by the label is active. This section describes each annunciator. Refer to Figure No. 13 for the location of the annunciators.

Symbol	Name	Description
→0←	ZERO	This annunciator is turned on to indicate that the weight displayed is within $\pm 1/4$ division of true zero.
▾	STABLE	This annunciator is turned on when the weight display is stable. When off, it means that the change in successive weight samples is greater than the motion limits selected during setup.
n	NET	This annunciator is turned on when the displayed weight is Net weight (Gross weight less Tare weight).
G	GROSS	This annunciator is turned on to show that gross weight is displayed. Gross weight will be displayed when no tare weight is stored.
T	TARE	This annunciator is turned on to show that the displayed weight is the tare weight.
lb	pounds	This annunciator is located to the right of the weight display and is turned on to show that the displayed weight unit is pounds.
oz	ounces	This annunciator is located to the right of the weight display and is turned on to show that the displayed weight unit is ounces.

<p>kg</p>	<p>kilograms</p>	<p>This annunciator is located to the right of the weight display and is used to indicate that the displayed unit of weight measurement is kilograms.</p>
<p>g</p>	<p>grams</p>	<p>This annunciator is located to the right of the weight display and is used to indicate that the displayed unit of weight measurement is grams.</p>
<p>☐</p>	<p>COUNT</p>	<p>This annunciator shows that the display is in the Count mode and the value displayed is in pieces (the count quantity) and not weight.</p>
<p>☐ And A or n And A</p>	<p>ACCUMULATOR</p>	<p>This annunciator shows that the displayed value is the content of the accumulator.</p>
<p>▼ IN1</p>	<p>DIGITAL INPUT</p>	<p>This annunciator is used to signal that a remote key function has been activated.</p> <p>Note that this annunciator is active only when the Digital Input feature has been enabled. Refer to the <i>d in</i> parameter in Setup.</p>
<p>▼ OUT1 <</p>	<p>UNDER</p>	<p>This annunciator is used to signal that the displayed weight is less than the minimum value of acceptable weight used in the Checkweigher feature or that preset 1 is active.</p> <p>Note that this annunciator is active only when the Checkweigher feature or the preset feature has been enabled. Refer to the <i>d out</i> parameter in Setup.</p>

<p style="text-align: center;">▼ OUT2 ⊕</p>	<p style="text-align: center;">ACCEPT</p>	<p>This annunciator is used to signal that the displayed weight is within the acceptable weight limits for the Checkweigher feature.</p> <p>That is, the weight is equal to or greater than the minimum acceptable weight and equal to or less than the maximum acceptable weight.</p> <p>This annunciator is also used to indicate that preset 2 is active.</p> <p>Note that this annunciator is active only when the Checkweigher feature or the preset feature has been enabled. Refer to the <i>d oUt</i> parameter in Setup.</p>
<p style="text-align: center;">▼ OUT3 ></p>	<p style="text-align: center;">OVER</p>	<p>This annunciator is used to signal that the displayed weight is equal to or greater than the minimum value of over weight used in the Checkweigher feature</p> <p>This annunciator is also used to indicate that preset 3 is active.</p> <p>Note that this annunciator is active only when the Checkweigher feature or the preset feature has been enabled. Refer to the <i>d oUt</i> parameter in Setup.</p>

7.2 Battery Status



The battery status indicator will be displayed when a battery pack is installed. The number of bars indicates the level of charge.

Number of Bars	Level of Charge
4	100%
3	75%
2	50%
1	25%

Note that as the battery approaches full discharge, the outline of the battery will start to flash.



NOTE! When the indicator is connected to an external power supply and is charging the battery, the charge level status bars will scroll.

8. INDICATOR SETUP REVIEW

The 190 indicator allows several operational parameters to be reviewed and changed without breaking the calibration seal.

8.1 Accessing Setup Review

1. With the indicator ON, press **Fn/▲** key and then the **ZERO** key.
2. The display will change to show *t d =* (the prompt for selection of a 12 or 24 hour clock).
3. Press the **TARE ↵** key to show the current setting. If the setting displayed is acceptable, press the **TARE ↵** key again to save it. Otherwise, use the **Fn/▲** key to toggle to a new setting and then press the **TARE ↵** key to save it and advance to the next prompt.
4. To exit Setup Review, press the **TARE ↵** key to step through the remaining prompts *OR* at anytime, cycle the power (press the **ON/OFF** key twice).

<i>t d =</i>	Time and Date (Select 12 or 24 hour clock)
<i>d i n =</i>	Digital Input (Disable or Select key function)
<i>d o u t =</i>	Digital Output (Disable or Select Preset/Checkweigher function)
<i>S L E E P =</i>	Sleep Mode (Disable or Select number of minutes before entering sleep mode)
<i>A o f f =</i>	Auto Shutoff (Disable or Select number of minutes before automatic shutoff)
<i>S i o ?</i>	Serial Input/Output Configuration (Select YES or NO)
<i>b a u d =</i>	Select Serial Port Baud Rate
<i>P a r i t y =</i>	Select Serial Port Parity
<i>C o n t i =</i>	Enable or Disable Continuous Output to the Serial Port
<i>t y p e =</i>	If <i>C o n t i = Y E S</i> (Select Continuous Output Format, SMA or Cardinal Scoreboard)

PrintP	Print Tab Settings Configuration (Select YES or NO)
Port:	Disable or Select Serial Interface for Printing
Hour:	Time Print Location
date:	Date Print Location
Gross:	Gross Weight Print Location
Tare:	Tare Weight Print Location
Net:	Net Weight Print Location
G ACC:	Gross Weight Accumulator Print Location
n ACC:	Net Weight Accumulator Print Location
Count:	Count "number of pieces on the scale" Print Location
ERCH:	Piece Weight Print Location
CRLF:	Carriage Return Line Feed (<i>Data Format Termination</i>)
EOP:	End-Of-Print Line Feeds
OptP	Options Configuration (Select YES or NO)
Opt:	Select Option Card Installed
baud:	Select Option Card Baud Rate when Opt = 0 or 1
Parity:	Select Option Card Parity when Opt = 0 or 1
Cont2:	Enable or Disable Continuous Output to the Option Port
TYPE:	If Opt = 1 and Cont2 = YES (Select Continuous Output Format, SMA or Cardinal Scoreboard)
baud:	Select Field Bus Option Baud Rate when Opt = 2
Addr:	Select Field Bus Option MAC Address when Opt = 2
ColorP	Display Backlight Color Setup (Select YES or NO)
dfLT:	Select Default Backlight Color
Under:	Select Checkweigher "Under" Backlight Color
Accept:	Select Checkweigher "Accept" Backlight Color
Over:	Select Checkweigher "Over" Backlight Color

9. OPERATION

9.1 Ticket Format Selection

The 190 includes support for visual tickets. Visual tickets are designed by the PC based programs Visual Print or nControl and then downloaded to the indicator.

The 190 allows one programmable format in addition to the standard print tab settings format.

1. Press the **Fn/▲** key then the **PRINT** key.
2. The display will change to show *P r t z*.
3. Press the **TARE ↵** key to show the current value.
4. If the setting displayed is acceptable, press the **TARE ↵** key again to save it.
5. Otherwise, press the **Fn/▲** key to "toggle" between the different available settings and then press the **TARE ↵** key to save it.
Allowable settings are:

0 = print tab settings

1 = visual ticket format



NOTE! When a print format is selected, it will remain active until changed by the operator.

```
#2
10:19 09/23/2010
100.00 lb G
20.00 lb T
80.00 lb N
      0.00 lb GROSS ACCUM
272.00 lb NET ACCUM
```

TICKET EXAMPLE

9.2 Preset Weight Comparators

The Model 190 indicator has three (3) outputs, which can be configured during setup to perform as Preset Weight Comparators “PWC”. The output state of each PWC (before reaching the preset weight) is defined in section 4.4 SETUP, the *d o u t =* (Digital Output) parameter.

With the PWC feature selected, during operation the indicator will compare each enabled preset weight value with the displayed weight and then output a signal for each preset based on the comparison results.

9.2.1 Entering Preset Weight Comparators Values

1. To enter the Preset Weight Comparators values, simultaneously press the **Fn/▲** key and the **PRINT** key.
2. Press the **TARE ↵** key.
3. The display will change to show *P r t =* (the prompt for Print Ticket Format selection). Refer to section 9.1 for details on selecting a Print Ticket Format.
4. Press the **TARE ↵** key again to skip the Print Ticket Format selection.
5. The display will change to show *P S E t =*.
6. Press the **TARE ↵** key to display the current value of the first preset weight value.
7. If the setting displayed is acceptable, press the **TARE ↵** key again to save it.
8. Otherwise, use the **Fn/▲** and **UNITS/◀** keys to enter a new value for the preset weight.
9. When the desired value is displayed, press the **TARE ↵** key to save it.
10. Continue with this procedure until a value for each preset to be used has been entered.
11. After the last preset value has been entered and the **TARE ↵** key pressed, the indicator will return to the weight display.

9.2.2 Preset Weight Comparators Operation

The preset weight comparators are used to control peripheral devices used in some form of process control. The number of comparators used depends upon system needs.

For example, in a simple filling operation, a single comparator may be used to open or close a gate which dumps material on the scale. In a more complex application, more comparators may be used for high speed/low speed filling.

The `d_out =` (Digital Output) setup parameter selects how many comparators are being used and the state of the output when the scale weight is below the preset target or cutoff weight. The output can be in one of two states: connected to the common pin on the i/o connector or not connected to the common pin on the i/o connector. When the scale weight is greater than or equal to the cutoff weight, the output will change state.

9.3 Hold Function

With the Hold function enabled during setup of the indicator, the function must be activated before it can be used.

Refer to section 4.15 Function Setup, the *FUNC (FUNC?)* parameter to enable the **Fn/▲** key Hold function.

NOTE! This function is not available when Legal-For-trade (*LFt = YES*) has been selected in setup. In addition, only one of the functions Hold, Count, Peak Hold, Checkweigher or Live Weight can be active at a time.

9.3.1 Activate Hold Function

1. Press and hold the **Fn/▲** key until the display blanks.
2. Once the display blanks, release the **Fn/▲** key
3. The display will change to show *Hold X*, the prompt and status of the Hold function.
4. If the setting displayed is acceptable, press the **TARE ↵** key to save it. Otherwise, use the **Fn/▲** key to toggle to a new setting and then press the **TARE ↵** key to save it.

! = Hold Function Active

□ = Hold Function Not Active

5. Repeatedly press the **TARE ↵** key to step through the remaining function prompts until the indicator returns to the weight display.

9.3.2 Hold Function Operation

1. With the Hold function enabled and activated, momentarily press the **Fn/▲** key and the display will lock at its current weight reading.
2. Press the **PRINT** key to print the held reading.
3. Press the **NET/GROSS, ZERO, TARE ↵**, or **UNITS/◀** key to release the hold and return to the weight display.

9.4 Count Function

With the Count function enabled during setup of the indicator, the function must be activated before it can be used.

Refer to section 4.15 Function Setup, the *FUNC (FUNC?)* parameter to enable the **Fn/▲** key Count function.

NOTE! This function is not available when Legal-For-trade (*LFt = YES*) has been selected in setup. In addition, only one of the functions Hold, Count, Peak Hold, Checkweigher or Live Weight can be active at a time.

9.4.1 Activate Count Function

1. Press and hold the **Fn/▲** key until the display blanks.
2. Once the display blanks, release the **Fn/▲** key
3. Press the **TARE ↵** key until the display shows *Count X*, the prompt and status of the Count function.
4. If the setting displayed is acceptable, press the **TARE ↵** key to save it. Otherwise, use the **Fn/▲** key to toggle to a new setting and then press the **TARE ↵** key to save it.

! = Count Function Active

□ = Count Function Not Active

5. Repeatedly press the **TARE ↵** key to step through the remaining function prompts until the indicator returns to the weight display.

9.4.2 Count Function Operation

1. Press the **Fn/▲** key. If no average piece weight has been set, the display will show *Add = 5*.
2. Repeatedly press the **Fn/▲** key to cycle through the sample sizes 5, 10, 25, 50, and 75 pieces.
3. Alternatively, press the **UNITS/◀** key. The digit will start to flash.
4. Repeatedly press the **Fn/▲** key until the desired value is displayed.
5. Press the **UNITS/◀** key to select the next digit.
6. Add the number of pieces to the scale and press the **TARE ↵** key.
7. The display will change to show the number of pieces on the scale.

8. Additional pieces may be added and the display will show the total number of pieces.
9. Press the **NET/GROSS** key to return to the weight display.

After the average piece weight has been set, pressing the **Fn/▲** key will go directly to displaying piece count.

To change the average piece weight, press the **Fn/▲** key a second time and the *Add = 5* prompt will be displayed.

To quit the sampling process without changing the average piece weight, set the sample size to 0 and press the **TARE ↵** key.

9.5 Time and Date Functions

With the Time and Date function enabled during setup of the indicator, the function must be activated before it can be used.

Refer to section 4.15 Function Setup, the *FUNC (FUNC?)* parameter to enable the **Fn/▲** key Time and Date function.

NOTE! With *USA=YES*, the date format is month-day-year. If *USA=NO*, the date format is day-month-year.

9.5.1 Set the Time

1. Press and hold the **Fn/▲** key until the display blanks.
2. Once the display blanks, release the **Fn/▲** key
3. Press the **TARE ↵** key until the display shows the time prompt, HH:MM X. Note that X will be A for AM or P for PM.
4. If the time displayed is correct, press the **TARE ↵** key to save it.
5. Otherwise, press the **Fn/▲** key to toggle between A and P.
6. Next, press the **UNITS/◀** key to select the digit of the minutes or hour to change.
7. Press the **Fn/▲** key to change the digit's value.
8. When the correct time is displayed, press the **TARE ↵** key to save it.
9. Repeatedly press the **TARE ↵** key to step through the remaining function prompts until the indicator returns to the weight display.

9.5.2 Set the Date

1. Press and hold the **Fn/▲** key until the display blanks.
2. Once the display blanks, release the **Fn/▲** key.
3. Press the **TARE ↵** key until the display shows the date prompt.
4. If the date displayed is correct, press the **TARE ↵** key to save it.
5. Otherwise, use the **UNITS/◀** key to select the digit of the month, day or year to change and then use the **Fn/▲** key to change the digit's value.
6. When the correct date is displayed, press the **TARE ↵** key to save it.
7. Repeatedly press the **TARE ↵** key to step through the remaining function prompts until the indicator returns to the weight display.

9.6 Peak Hold Function

With the Peak Hold function enabled during setup of the indicator, the function must be activated before it can be used.

Refer to section 4.15 Function Setup, the *FUNC (FUNC?)* parameter to enable the **Fn/▲** key Hold function.

NOTE! Only one of the functions Hold, Count, Peak Hold, Checkweigher or Live Weight can be active at a time.

9.6.1 Activate Hold Function

1. Press and hold the **Fn/▲** key until the display blanks.
2. Once the display blanks, release the **Fn/▲** key
3. The display will change to show *PHoL dX*, the prompt and status of the Peak Hold function.
4. If the setting displayed is acceptable, press the **TARE ↵** key to save it. Otherwise, use the **Fn/▲** key to toggle to a new setting and then press the **TARE ↵** key to save it.

! = Peak Hold Function Active

□ = Peak Hold Function Not Active

6. Repeatedly press the **TARE ↵** key to step through the remaining function prompts until the indicator returns to the weight display.

9.6.2 Peak Hold Function Operation

When the Peak Hold function is active, the largest weight value measured since Peak Hold was activated (or cleared) will be stored.

1. To display the peak value, momentarily press the **Fn/▲** key.
2. To zero the peak value, make sure there is no load on the scale and press the **ZERO** key.
3. Press the **NET/GROSS** key to return to the weight display.

9.7 Checkweigher

The Model 190 indicator has logic level outputs that can be used to control peripheral devices used to signal when the weight is within preset limits. The output state of the Checkweigher (before reaching the preset weight) is defined in section 4.4 SETUP, the *d o u t =* (Digital Output) parameter. Note that these outputs are at logic level and cannot drive external devices directly. Solid-state relays can be used to accept the logic level outputs from the 190 and in turn, drive the external device.

With the Checkweigher function enabled during setup of the indicator, the function must be activated before it can be used.

Refer to section 4.15 Function Setup, the *F U n C* (*F U n C ?*) parameter to enable the **Fn/▲** key Hold function.

NOTE! Only one of the functions Hold, Count, Peak Hold, Checkweigher or Live Weight can be active at a time.

9.7.1 Activate Checkweigher and Set Minimum Acceptable Weight Value

1. Press and hold the **Fn/▲** key until the display blanks.
2. Once the display blanks, release the **Fn/▲** key
3. The display will change to show the first function prompt.
4. Repeatedly press the **TARE** \leftarrow key until the *L o =* prompt is displayed.
5. Press the **TARE** \leftarrow key once again.
6. The display will show the current value for the minimum acceptable weight.

\square = Checkweigher Function Not Active

XXXXX = Minimum Acceptable Weight (Checkweigher is Active)

7. If the setting displayed is acceptable, press the **TARE** \leftarrow key to save it.
8. Otherwise, use the **Fn/▲** and **UNITS/◀** keys to enter a new value for the minimum acceptable weight.
9. When the desired value is displayed, press the **TARE** \leftarrow key to save it.
10. Repeatedly press the **TARE** \leftarrow key to step through the remaining function prompts until the indicator returns to the weight display.

9.7.2 Entering Maximum Acceptable Weight Value

1. Press and hold the **Fn/▲** key until the display blanks.
2. Once the display blanks, release the **Fn/▲** key
3. The display will change to show the first function prompt.
4. Repeatedly press the **TARE ↵** key until the **H =** prompt is displayed.
5. Press the **TARE ↵** key once again.
6. The display will show the current value for the maximum acceptable weight.
7. If the setting displayed is acceptable, press the **TARE ↵** key again to save it.
8. Otherwise, use the **Fn/▲** and **UNITS/◀** keys to enter a new value for the maximum acceptable weight.
9. When the desired value is displayed, press the **TARE ↵** key to save it.
10. Repeatedly press the **TARE ↵** key to step through the remaining prompts until the indicator returns to the weight display.

9.7.3 Checkweigher Operation

With the Checkweigher function enabled and activated, during operation the indicator will compare the displayed weight with the preset values and display the results as under, accept, or over.

When the displayed weight is less than the minimum acceptable weight, the arrow over **OUT1 <** (the UNDER annunciator) will turn on and the display will change to the color selected in section 4.15, Display Backlight Color Setup.

When the displayed weight is greater than the maximum acceptable weight, the arrow over **OUT3 >** (the OVER annunciator) will turn on and the display will change to the color selected in section 4.15, Display Backlight Color Setup.

When the displayed weight is within the range from minimum acceptable weight to maximum acceptable weight, the arrow over **OUT2 ⊕** (the ACCEPT annunciator) will turn on and the display will change to the color selected in section 4.15, Display Backlight Color Setup.

9.8 Live Weight Function

With the Live Weight function enabled during setup of the indicator, the function must be activated before it can be used.

Refer to section 4.15 Function Setup, the *FUNC (FUNC?)* parameter to enable the **Fn/▲** key Hold function.

NOTE! This function is not available when Legal-For-trade (*LFt = YES*) has been selected in setup. In addition, only one of the functions Hold, Count, Peak Hold, Checkweigher or Live Weight can be active at a time.

9.8.1 Activate Live Weight Function

1. Press and hold the **Fn/▲** key until the display blanks.
2. Once the display blanks, release the **Fn/▲** key
3. The display will change to show *RLt* X, the prompt and status of the Live Weight function.
4. If the setting displayed is acceptable, press the **TARE** \leftarrow key to save it. Otherwise, use the **Fn/▲** key to toggle to a new setting and then press the **TARE** \leftarrow key to save it.

l = Live Weight Function Active

□ = Live Weight Function Not Active

5. Repeatedly press the **TARE** \leftarrow key to step through the remaining function prompts until the indicator returns to the weight display.

9.8.2 Live Weight Function Operation

With the Live Weight function enabled and activate, make sure the scale platform is empty, and then simultaneously press the **NET/GROSS** and the **UNITS/◀** key.

The Hold annunciator will flash.

Load the scale platform.

When a stable value has been reached, the Hold annunciator will be on steadily and the display will lock.

Press the **NET/GROSS** key to return to the weight display.

9.9 Accumulated Weight Function

When the accumulated weight function has been enabled during setup of the indicator, the function must be activated before it can be used.

Refer to section 4.15 Function Setup, the *FUNC (FUNC?)* parameter to enable the **Fn/▲** key Hold function.

NOTE! If Legal-For-trade (*LFt = YES*) has been selected in setup, the Gross weight must return to zero before the next weighing operation to enable accumulation.

9.9.1 Activate Accumulated Weight Function

1. Press and hold the **Fn/▲** key until the display blanks.
2. Once the display blanks, release the **Fn/▲** key
3. The display will change to show *ACCU X*, the prompt and status of the Accumulated Weight function.
4. If the setting displayed is acceptable, press the **TARE** \leftarrow key to save it. Otherwise, use the **Fn/▲** key to toggle to a new setting and then press the **TARE** \leftarrow key to save it.

i = Accumulated Weight Function Active

\square = Accumulated Weight Function Not Active

5. Repeatedly press the **TARE** \leftarrow key to step through the remaining function prompts until the indicator returns to the weight display.

9.9.2 Accumulated Weight Function Operation

During operation, the weight recorded when the **PRINT** key is pressed will be added to the accumulator. This will be indicated by *totAL* being displayed briefly after the **PRINT** key has been pressed.

1. To display the Accumulator, simultaneously press the **UNITS/◀** and **TARE** \leftarrow keys. If Legal-For-trade (*LFt = YES*) is on, the gross load must be zero.
2. The Gross accumulator weight will be displayed as indicated by the alternating \square and *R*.
3. After a brief interval, the display will show the number of Gross weight items accumulated, indicated by the alternating \square and *L*.

4. The display will alternate between showing the Gross accumulator weight and the Gross accumulator count.
5. Press the **TARE** \leftarrow key and the Net accumulator weight will be displayed, indicated by the alternating n and R .
6. After a brief interval, the display will show the number of Net weight items accumulated, indicated by the alternating n and $\bar{}$.
7. The display will alternate between showing the Net accumulator weight and the Net accumulator count.
8. Press the **TARE** \leftarrow key to display the Gross accumulator again.
9. Press the **ZERO** key to clear the displayed accumulator.
10. Press the **NET/GROSS** key to return to normal weight display.

10. ERROR MESSAGES

10.1 Before You Call Service

The Cardinal 190 Weight Indicator has been designed to provide you with years of trouble-free operation. However, should you experience a problem, please refer to the troubleshooting guide below before you call for service. The following describes several types of symptoms along with suggested remedies.

PROBLEM	POSSIBLE SOLUTIONS
Display does not turn on	<p>AC operation:</p> <p>Is the AC power cord fully inserted into the wall receptacle?</p> <p>Check wall receptacle for proper AC power.</p> <p>Try another electrical appliance in the same receptacle, does it work?</p> <p>Check the circuit breaker.</p> <p>Has there been power failure?</p> <p>Battery operation:</p> <p>Check if battery is installed correctly.</p> <p>Is battery discharged? Replace or recharge.</p>
Incorrect weight displayed	<p>Has the indicator been calibrated?</p> <p>Insure that the scale platform isn't touching an adjacent object.</p> <p>Check the load cell connector wiring.</p> <p>If using four (4) wire load cells, insure the sense lead jumpers (J4 & J5) are installed.</p> <p>Have proper operation procedures been followed?</p>
Indicator will not display weight	<p>Refer to Error Codes section and make certain that the "oC RP" message is not displayed. If so, and scale is not loaded, perform the calibration procedure.</p>

<p>The printer prints but does not use the Print Tab Settings or prints a test ticket</p>	<p>The print tab setting or visual ticket format must be selected prior to beginning the weighing operation or just prior to printing the ticket.</p> <p>To select the ticket format prior to beginning the weighing operation:</p> <ol style="list-style-type: none">1. Press the Fn/▲ key then the PRINT key. The display will change to the "Pr t _".2. Press the TARE ↵ key to show the current value.3. If the value displayed is acceptable, press the TARE ↵ key again to save it.4. If the displayed value is incorrect (or another ticket format is desired), use the Fn/▲ key to toggle to a new setting and then press the TARE ↵ key to save it. <p>Allowable values for ticket formats are:</p> <ul style="list-style-type: none">0 = print tab settings1 = visual ticket format <p>NOTE! When a print format is selected, it will remain active until changed by the operator.</p>
---	---

10.2 Error Codes

The Cardinal 190 Weight Indicator is equipped with software that indicates when an error in the operation takes place. The following lists the error codes displayed by the 190 along with their meaning. Should you encounter an error code, please refer to this list for the cause.

Error	Cause (A.) and Corrective Action (B.)
<i>CONF 19</i>	<p>A. Calibration required.</p> <p>B. Calibrate the scale with test weights.</p>
<i>ERRA H</i>	<p>A. The analog input is off scale at the upper end of the input range.</p> <p>B. Check wiring and load cell.</p>
<i>ERRA L</i>	<p>A. The analog input is off scale at the lower end of the input range.</p> <p>B. Check wiring and load cell.</p>
<i>Error</i>	<p>A. Attempt to perform an illegal function:</p> <ol style="list-style-type: none"> 1. Performing a hold operation when the weight is invalid (e.g., overcapacity). 2. Attempting to clear Tare with Gross weight greater than zero (<i>LFt = 1, uSR = 0</i>). 3. Attempting to zero scale when there is motion present or the scale is over capacity. 4. Attempting to zero scale when Gross weight is out of zero range (<i>t-r-L = 4E5</i>). 5. Attempting to print when scale is over capacity. 6. Attempting to do a span adjustment with insufficient load on the scale. 7. Attempting to tare scale when there is motion present or the Gross weight is below zero or over capacity.
<i>Lo bAt</i>	<p>A. This message is used with the battery operation and will turn ON to indicate the battery does not have a sufficient charge and requires recharging.</p> <p>If continued use furthers drains the battery, no change in operation will occur until just before the battery voltage drops to a level where operation is affected. At this level, the indicator will automatically turn off.</p> <p>B. Charge the battery pack or replace it.</p>

Error	Cause (A.) and Corrective Action (B.)
<i>not Tare</i>	The NET/GROSS key was pressed when there is no stored tare.
<i>oCAP</i>	A. The load on the scale exceeds the capacity of the scale. B. Remove the excess load.
<i>-oF-</i>	A. The indicator is trying to display a positive number with more than six digits or a negative number with more than five digits. B. Return to Gross weight mode and review the Tare weight. Might indicate incorrect calibration.
<i>UnStb</i>	A. Motion was present when a print was initiated. B. Wait for a stable indication before printing.

11. EVENT COUNTERS

11.1 Event Counters

A Category 1 Event Counter is provided on the 190 with two event counters that increment when a change is made to features that are required by NTEP or OIML to be sealed. One counter is designated for calibration parameters and one is designated for configuration changes as required in NCWM Publication 14, 2007. Each event counter's data is maintained in non-volatile memory and can be viewed by a Weights and Measures inspector.

The calibration event counter (CAL) will be incremented once each time Setup mode is entered and a change is made to at least one calibration parameter (span adjustment, coarse zero adjustment, etc.). Up to 10,000 calibration events can be counted.

The configuration event counter (CFG) will be incremented once each time Setup mode is entered and a change is made to at least one configuration parameter. Up to 10,000 configuration events can be counted.

11.2 Accessing the Event Counters

1. With the indicator ON, press the **Fn/▲** key and then press the **NET/GROSS** key.
2. The display will change to show CAL .
3. Press the **TARE** \leftarrow key.
4. The display will change to show the current value for the number of times the indicator has been calibrated.
5. Press the **TARE** \leftarrow key.
6. The display will change to show CFG .
7. Press the **TARE** \leftarrow key.
8. The display will change to show the current value for the number of times the indicator has had a configuration change.
9. Press the **TARE** \leftarrow key.
10. The indicator will return to the normal weight display.

Configuration Parameters

<i>USA</i>	Domestic or International
<i>LFT</i>	Legal For Trade
<i>Unit 1</i>	Weighing Units 1 (Primary Units)
<i>Int</i>	Interval Setting
<i>dPP</i>	Decimal Point Precision
<i>CRP</i>	Capacity
<i>Unit 2</i>	Weighing Units 2 (Secondary Units)
<i>trR</i>	Zero Tracking Range
<i>trL</i>	4% Zero Limit
<i>PU0</i>	Power Up Zero
<i>dFLT</i>	Digital Filter Number
<i>F</i>	Filter Level Amount
<i>b</i>	Filter Break Range
<i>Sr</i>	Sample Rate
<i>Un5</i>	Motion Range
<i>SC</i>	Stable Count

12. TEST MODE/ DIAGNOSTICS

12.1 Test Mode/Diagnostics Features

The Cardinal Model 190 Weight Indicator has a comprehensive diagnostics feature that can allow it to self diagnose a problem. After displaying the model number, software revision and performing a display test, the indicator will enter the diagnostics mode.

The diagnostics feature will check to ensure that the internal memory is functioning correctly, that setup parameters (as well as other operational parameters) are within range and that the battery (if equipped with batteries) voltage is correct for operation.

12.2 Accessing Test Mode/Diagnostics

To access the Test Mode/Diagnostics feature, with the indicator ON, press the **Fn/▲** key and then press the **UNITS/◀** key. Each test lasts about one second.

1. The model number (190) will be displayed
2. The software version (r #.#.#) will be displayed.
3. All horizontal segments will turn on and then off.
4. All vertical segments and decimal points will turn on and then off.
5. The key status arrows will turn on and then off.
6. Each weight mode annunciator (lb, kg, etc.) will turn on and then off.
7. The diagnostics feature will perform an internal memory check, verify that the setup parameters (and other operational parameters) are within range and if equipped with batteries, that the voltage is correct for operation.
8. *SETUP=* and *PASS* will be displayed if everything passes the diagnostic check.
9. The calibration numbers (C1 to C4) will be displayed.

13. PARTS IDENTIFICATION

13.1 Front Sub Assembly

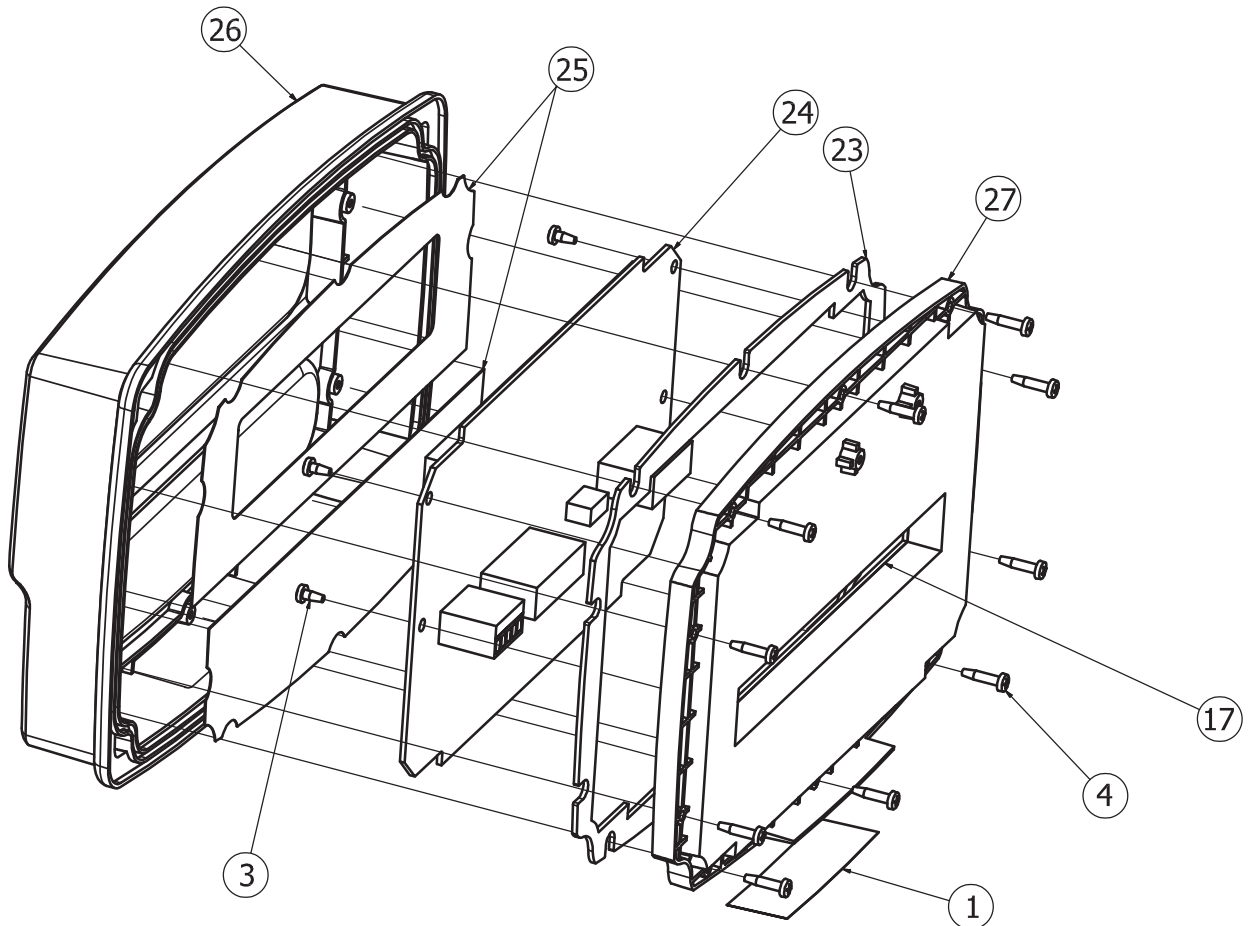

ITEM NO.	QTY.	PART NUMBER	DESCRIPTION
1	1	593GR986	SERIAL TAG ASSY
3	8	6021-1286	SCW PAN-HEAD PLASTIC THD. ROLLING, #4x1/4, PHIL. DR. Z-PLATE
4	10	6021-1287	SCW PAN-HEAD PLASTIC THD. ROLLING, #4x1/2, PHIL. DR. Z-PLATE
17	1	8400-B014-08	CONNECTOR GASKET, 190
23	1	8400-C013-08	CENTER GASKET, 190
24	1	8400-D003-0A	PCB ASSY 190 CONTROLLER
25	1	8400-D008-08	190 OVERLAY
26	1	8400-D010-08	PLASTIC FRONT, 190
27	1	8400-D011-08	PLASTIC CENTER, 190

13.2 Rear Sub Assembly

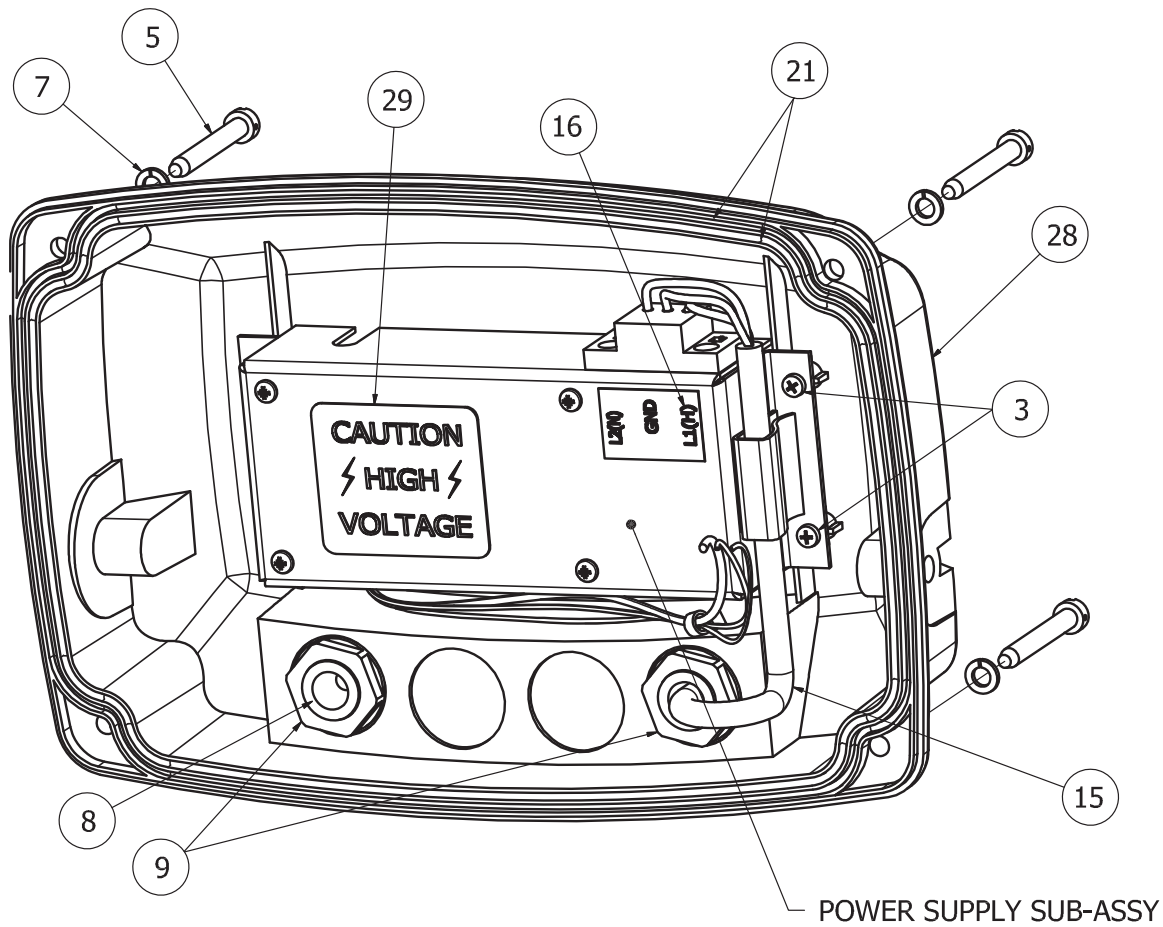

ITEM NO.	QTY.	PART NUMBER	DESCRIPTION
3	8	6021-1286	SCW PAN-HEAD PLASTIC THD. ROLLING, #4x1/4, PHIL. DR. Z-PLATE
5	4	6021-1288	SCW FILLISTER MACHINE-SCW 10-32X1.5. DL HOLE ONE WAY S.S.
7	4	6024-0037	WASHER LOCK HELICAL SP #10 REG SS
8	1	6540-1104	PLUG, HOLE 0.343" X 0.187" X 1" LG, SILICONE RUBBER
9	2	6610-2248	CONN GLAND .187-.312 GRIP .599 MTG BLK
15	1	6980-1030	POWER CORD 18/3 SVT CEE 6.3 FT
16	1	8200-B104-08	LABEL: 205-210 TERM. BLOCK
21	2	8400-B020-08	O-RING, 190
28	1	8400-D012-08	PLASTIC BACK, 190
29	1	8510-C346-0I	LABEL CAUTION HIGH VOLTAGE

13.3 Power Supply Sub Assembly

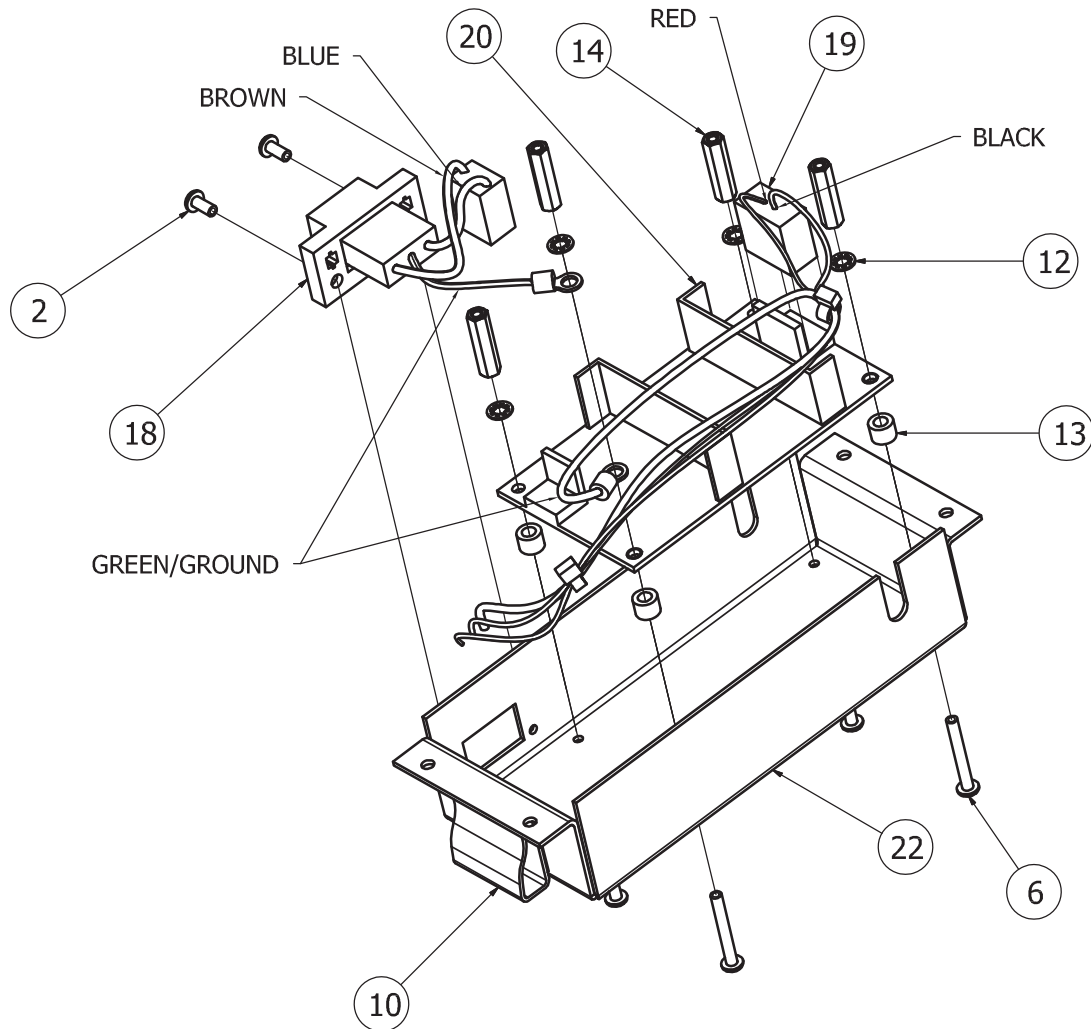

ITEM NO.	QTY.	PART NUMBER	DESCRIPTION
2	2	6021-0423	SCW PAN-HEAD.. MACHINE-SCW 04-40X.250
6	4	6021-2018	SCW PAN-HEAD.. MACHINE-SCW 04-40X.875
10	1	6610-5007	CABLE CLIP, 1" X 1" GREY
12	4	6680-0026	WASHER LOCK INT TOOTH # TYPE A Z-PL
13	4	6680-0138	SPACER #6 X .187 NYLON
14	4	6680-1107	SPACER #4-40X.750 3/16 HEX ALU. Z/P
18	1	8400-B017-0A	190 AC POWER CABLE (See Section 12.4 AC Wiring Detail)
19	1	8400-B018-0A	DC POWER CABLE, 190
20	1	8400-B019-08	POWER SUPPLY, 190
22	1	8400-C005-08	POWER SUPPLY COVER, 190

13.4 AC Wiring Detail

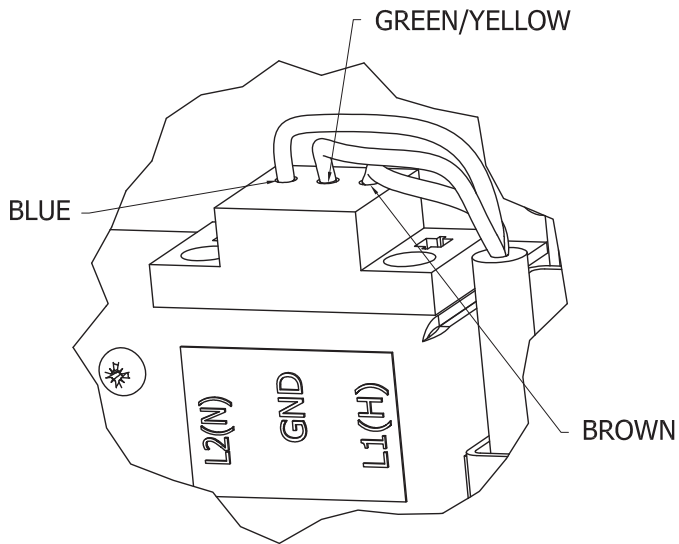

STATEMENT OF LIMITED WARRANTY

WARRANTY TERMS

Cardinal Scale Manufacturing Company warrants the equipment we manufacture against defects in material and workmanship. The length and terms and conditions of these warranties vary with the type of product and are summarized below:

PRODUCT TYPE	TERM	MATERIAL AND WORKMANSHIP	LIGHTNING DAMAGE See note 9	WATER DAMAGE See note 7	CORROSION See note 4	ON-SITE LABOR	LIMITATIONS AND REQUIREMENTS
VEHICLE SCALE WEIGHT INDICATORS	1 YEARS	YES	YES	YES	YES	NO	1, 2, 3, 5, 6 A, B, C, D
VEHICLE SCALE LOAD CELLS Ex. Hydraulic	5 YEARS	YES	YES	YES	YES	90 DAYS	1, 2, 3, 5, 6 A, B, C, D
HYDRAULIC LOAD CELLS	LIFE	YES	YES	YES	YES	90 DAYS	1, 5, 6, 8 A, B, C, D
VEHICLE SCALE STRUCTURE	5 YEARS	YES	YES	YES	YES	90 DAYS	1, 2, 3, 5, 6 A, B, C, D, E
ALL OTHER CARDINAL PRODUCTS	1 YEAR	YES	NO	YES	YES	NO	1, 2, 5, 6 A, B, C, D, E
REPLACEMENT PARTS	90 DAYS	YES	NO	YES	YES	NO	1, 2, 4, 5, 6 A, B, C, D
IN-MOTION VEHICLE SCALES	1 YEAR	YES	NO	YES	YES	90 DAYS	1, 2, 5, 6 A, B, C, D

APPLICABLE LIMITATIONS AND REQUIREMENTS

1. This warranty applies only to the original purchaser. The warranty does not apply to equipment that has been tampered with, defaced, damaged, or had repairs or modifications not authorized by Cardinal or has had the serial number altered, defaced or removed.
2. This warranty is not applicable to equipment that has not been grounded in accordance with Cardinal's recommendations.
3. This equipment must be installed and continuously maintained by an authorized Cardinal dealer.
4. Applies only to components constructed from stainless steel.
5. This warranty does not apply to equipment damaged in transit. Claims for such damage must be made with the responsible freight carrier in accordance with freight carrier regulations.
6. Warranty term begins with date of shipment from Cardinal.
7. Only if device is constructed for outdoor use.
8. Lifetime warranty applies to damages resulting from water, lightning, and voltage transients and applies only to the hydraulic load cell structure itself (does not include pressure transducers, rubber seals, o-rings, and associated wiring).
9. Except for hydraulic load cells, warranty coverage for damage resulting from lightning is valid ONLY when the device is installed in strict accordance with Cardinal's installation instructions including the use of recommended grounding and surge suppression circuitry.

- Page 1 -



Ph. (800) 441-4237
E-mail: cardinal@cardet.com
203 E. Daugherty
Webb City, MO 64870

02/11
Printed in USA
315-WARRANTY-CAR-G

EXCLUSIONS

- A.)** This warranty does not include replacement of consumable or expendable parts. The warranty does not apply to any item that has been damaged due to unusual wear, abuse, improper line voltage, overloading, theft, fire, lightning, water, prolonged storage or exposure while in purchaser's possession or acts of God unless otherwise stated herein.
- B.)** This warranty does not apply to peripheral equipment not manufactured by Cardinal. This equipment will normally be covered by the equipment manufacturer's warranty.
- C.)** This warranty sets forth the extent of our liability for breach of any warranty or deficiency in connection with the sale or use of our product. Cardinal will not be liable for consequential damages of any nature, including but not limited to loss of profit, delays or expenses, whether based on tort or contract. Cardinal reserves the right to incorporate improvements in material and design without notice and is not obligated to incorporate said improvements in equipment previously manufactured.
- D.)** This warranty is in lieu of all other warranties expressed or implied including any warranty that extends beyond the description of the product including any warranty of merchantability or fitness for a particular purpose. This warranty covers only those Cardinal products installed in the forty-eight contiguous United States and Canada.
- E.)** This warranty does not cover paint coatings due to the variety of environmental conditions.

- Page 2 -



Ph. (800) 441-4237
E-mail: cardinal@cardet.com
203 E. Daugherty
Webb City, MO 64870

02/11
Printed in USA
315-WARRANTY-CAR-G



Printed in USA

Cardinal Scale Mfg. Co.

PO Box 151, Webb City, MO 64870

Telephone: 417-673-4631

FAX: 417-673-5001

www.cardinalscale.com

Technical Support: 866-254-8261

E-mail: techsupport@cardet.com