



TRANSCCELL TECHNOLOGY, INC.

PC-150

DIGITAL BENCH SCALE

Setup / Operation Manual



Revision 1.3
October 6, 2010

975 Deerfield Parkway Buffalo Grove, IL 60089
Tel (847) 419-9180 Fax (847) 419-1515
<http://www.transcell.com>

ATTENTION:

To extend the life of your digital scale, do not drop items to be weighed onto the platform or overload the scale beyond its rated capacity. Shock-loading and overloading may damage the load cell and void the warranty.

TABLE OF CONTENTS

TABLE OF CONTENTS	2
INTRODUCTION	2
INSTALLATION	3
DISPLAY OVERVIEW	4
KEYBOARD FUNCTIONS	5
USER MENU MODE	6
SETUP MENU MODE	8
CALIBRATION	10
SPECIFICATIONS	11
SERIAL PORT INFORMATION	12
ERROR CODES	13
WARRANTY AND SERVICE INFORMATION	14

INTRODUCTION

The PC-150 Digital Bench Scale is a compact, 150 lb (70 kg) capacity bench scale with display and five function keyboard. It comes standard with a bright LED screen for easy readout, a removable stainless steel platform, and an RS-232C serial communication port and a USB port.

The scale can be configured to display its divisions in two separate modes – non-NTEP mode and NTEP mode. The scale is shipped from the factory configured in non-NTEP mode. The NTEP mode is supplied for scales that need to comply with Handbook 44 requirements. To re-configure the scale, please refer to the “Setup Menu Mode” section of the manual.

The PC-150 has both an RS-232C and a USB port for communication with personal computers or remote displays. The scale can transmit data on demand or continuously in several popular data protocols.

The scale’s serial communication parameters are altered through the User menu. The “User Menu Mode” section of the manual explains how to use the five front panel keys to maneuver and save settings in this menu.

INSTALLATION

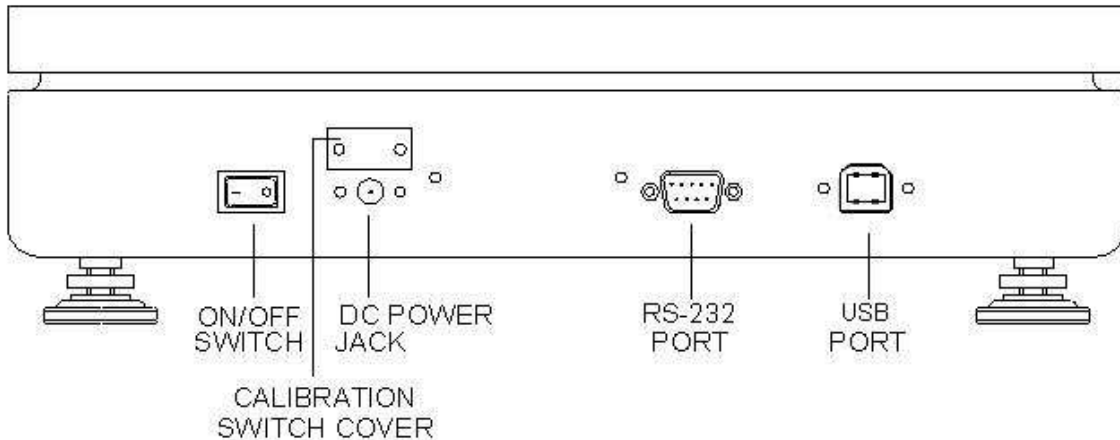

The PC-150 rear panel contains all necessary power switches, communication ports and power receptacles.

To install the scale:

Place the scale in its intended area of use.

- Ensure that the scale is placed securely on a flat and level surface. Use the adjustable feet to level out the scale and avoid rocking.
- *Avoid installing the scale in areas of direct sunlight and high humidity. Also avoid drafts, vibrations and dusty conditions.*
- To extend the life of your digital scale, do not drop items to be weighed onto the platform or overload the scale beyond its rated capacity. Shock-loading and overloading may damage the load cell and void the warranty.

Connect the scale to your computer (or other communication device) using the appropriate optional communication cable (RS-232 or USB). **NOTE:** This scale is not designed to use both ports at the same time. Doing so may damage the scale and void your warranty.

Plug the enclosed Desktop Switching Adapter into the scale's DC power jack first, then into an AC outlet.

Finally, turn the rocker switch to the ON ("1") position. After a brief initialization period, the scale is now ready for use.

DISPLAY OVERVIEW

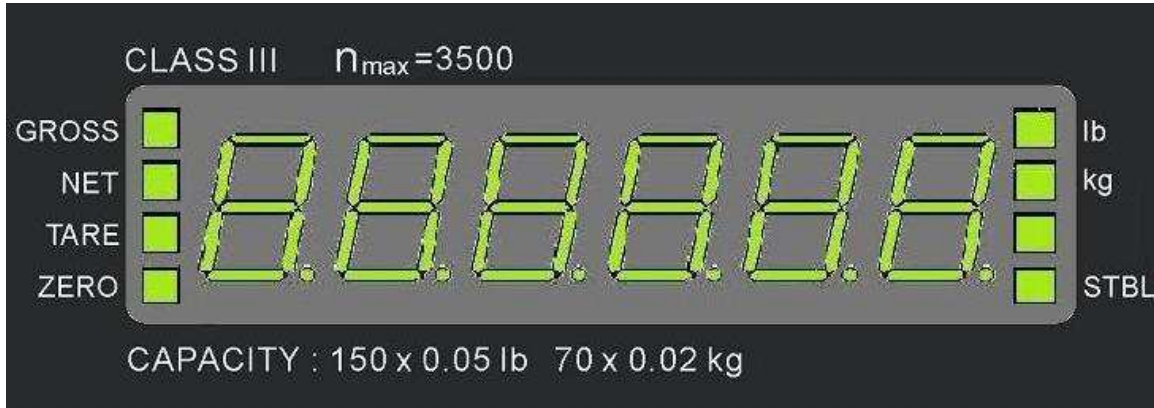

PC-150 Display Area

ANNUNCIATOR	MEANING
ZERO	Better known as the “Center of Zero” annunciator, this light is active whenever the displayed weight is within ± 0.25 divisions of true zero.
NET	Indicates that the scale is displaying net weight.
GROSS	Indicates that the scale is displaying gross weight.
TARE	Indicates that the tare weight in the system was established by means of the push button method.
lb and kg	Indicates the unit of the displayed weight.
STBL	This light indicates that the scale is stable.

KEYBOARD FUNCTIONS

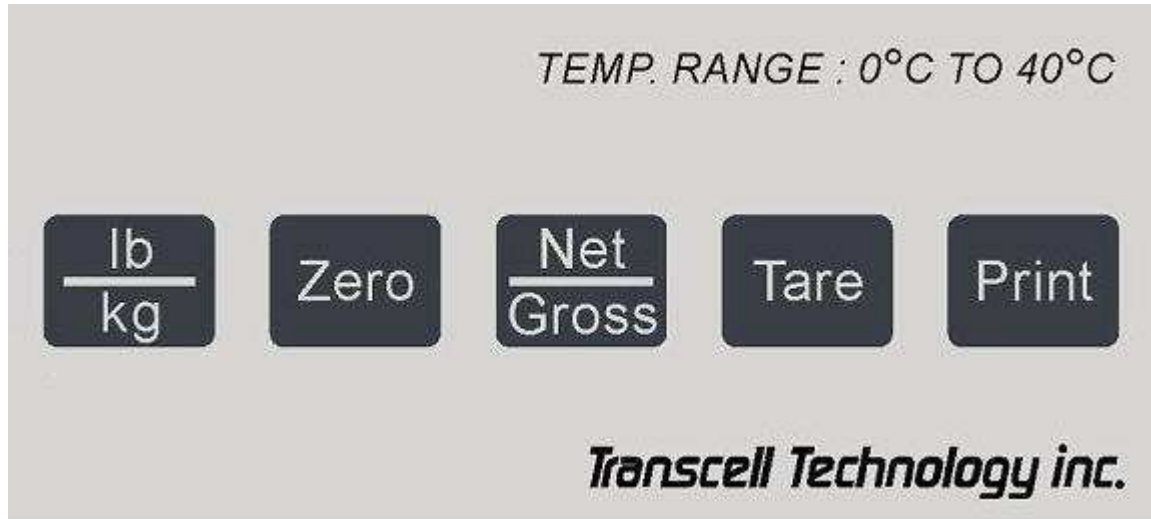

PC-150 Keyboard

KEY	FUNCTION
<div style="border: 1px solid black; border-radius: 10px; padding: 5px; width: fit-content; margin: 0 auto;">ZERO</div>	Sets scale to display "0" only when a) in Gross mode, b) not in overload and c) not in motion.
<div style="border: 1px solid black; border-radius: 10px; padding: 5px; width: fit-content; margin: 0 auto;">$\frac{\text{NET}}{\text{GROSS}}$</div>	Toggles between Gross and Net weight display if a tare has been established.
<div style="border: 1px solid black; border-radius: 10px; padding: 5px; width: fit-content; margin: 0 auto;">TARE</div>	Used to establish the weight on the platform as the tare weight. You cannot establish zero or negative gross weight as a tare. Also, the scale must not be in motion or in overload.
<div style="border: 1px solid black; border-radius: 10px; padding: 5px; width: fit-content; margin: 0 auto;">$\frac{\text{lb}}{\text{kg}}$</div>	Toggles between lb and kg units if enabled in the User ("A") Menu.
<div style="border: 1px solid black; border-radius: 10px; padding: 5px; width: fit-content; margin: 0 auto;">PRINT</div>	Sends "Print" data to serial port if scale is not in motion or in overload.

USER MENU MODE

The PC-150 scale includes a User menu that contains the scale's serial communication parameters. It consists of 5 separate menu selections, each also with its own sub-menu of choices.

To change a listed parameter, you must first enter the User Menu mode. Once there, four of the front panel keys become directional navigators to move around in the menus, and one key is used to save or SET the selections.

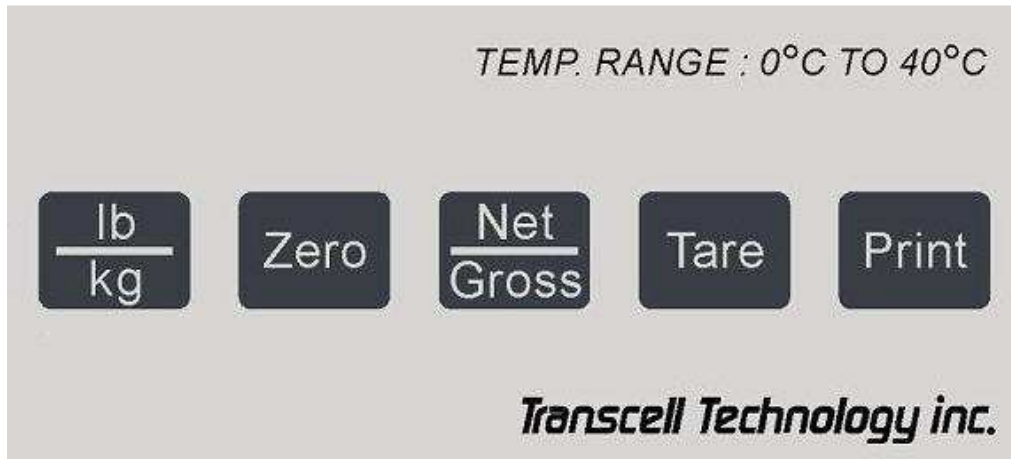

To place the scale into User menu mode:

1. Turn the power off to the unit by moving the rocker switch to the "O" position.
2. While holding down the **lb/kg** key, turn the power back on. When the display shows "A1", the unit is in User Menu mode, and you can release the **lb/kg** key.
3. To move to a new heading, use the Tare (left) or Print (right) key to move right or left in the Menu.
4. To move to the selection or programming level, press the Zero (down) key once. The currently saved selection is shown.
5. To view the available selections for the current heading, use the Tare (left) or Print (right) key to move through the selection field.
6. To save a new selection, press the Net/Gross (Set) key .To exit without saving, press the lb/kg (up) key to return to the current heading.
7. Repeat Steps 3 through 6 until the Menu is programmed.

USER MENU CHART

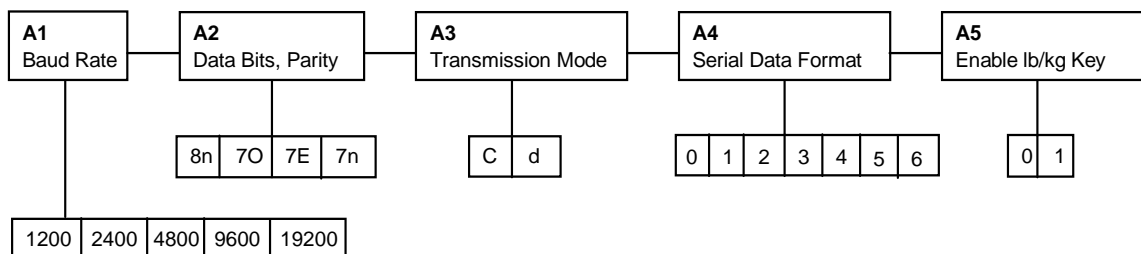

USER MENU DESCRIPTIONS

NAME/CODE	DESCRIPTION	CODE/VALUE
A1 Baud Rate	Selects the baud rate for data transmission through the serial port.	1200 2400 √ 4800 9600 19200
A2 Data Bits and Parity	Selects the number of data bits and parity of serial transmission. "8n" = 8 data bits with no parity bit and one stop bit "7O" = 7 data bits with odd parity bit and one stop bit "7E" = 7 data bits with even parity bit and one stop bit "7n" = 7 data bits with no parity bit and two stop bits	8n √ 7O 7E 7n
A3 Mode of Serial Transmission	Selects when data will be sent out of the serial port to a printer or computer: "C" = Continuous mode; send data continuously "d" = Demand mode; send data when a PRINT command is issued from the printer, computer, or scale.	C d √
A4 Serial Data Format	Selects the data format to be transmitted via the serial port to a printer or computer. "0" = Consolidated Controls Format "1" = Toledo 8213 Format "2" = NCI 3825Format "3" = Transcell Technology Format "4" = Detecto ASD Format "5" = Triner Format "6" = Fairbanks 70-2453-4 Format	0 1 2 3 √ 4 5 6
A5 Disable the lb/kg Key	Allows the lb/kg key to be disabled so that an operator cannot accidentally press the key and change the displayed units. "0" = Disable the lb/kg key "1" = Enable the lb/kg key	0 1 √

To place the scale back into the Normal Operating mode:

1. Turn off the scale.
2. Turn the scale back on without pressing any keys. The display will go through a digit check, and then settle into Normal Operating mode. All front panel keys will now return to their normal mode of operation.

SETUP MENU MODE

The PC-150 scale includes a Setup menu that determines the scale's display mode, allows scale calibration and also contains the scale's adjustable functional parameters. It consists of 5 separate menu selections, each also with its own sub-menu of choices.

To change a listed parameter, you must first enter the Setup Menu mode. Once there, four of the front panel keys become directional navigators to move around in the menus, and one key is used to save or SET the selections.

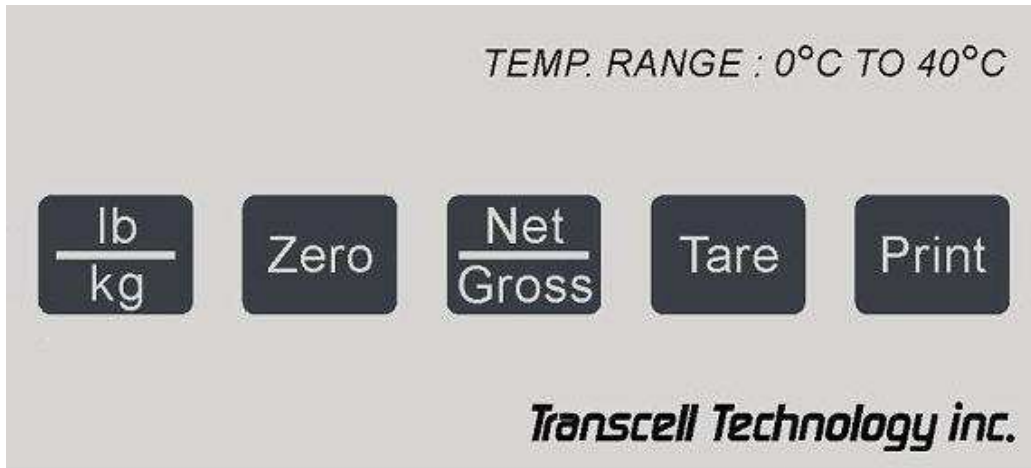

To place the scale into User menu mode:

1. Turn the power off to the unit.
2. Locate the slide switch on the rear panel and move it to the opposite position.
NOTE: A metal plate conceals the slide switch; remove the two drilled-head screws and cover plate to access the slide switch
3. While holding down both the **ZERO** and **PRINT** keys, turn the power back on. When the display shows "F 1", the unit is in Setup Menu mode, and you can release both keys.
4. To move to a new heading, use the Tare (left) or Print (right) key to move right or left in the Menu.
5. To move to the selection or programming level, press the Zero (down) key once. The currently saved selection is shown.
6. To view the available selections for the current heading, use the Tare (left) or Print (right) key to move through the selection field.
7. To save a new selection, press the Net/Gross (Set) key .To exit without saving, press the lb/kg (up) key to return to the current heading.
8. Repeat Steps 4 through 7 until the Menu is programmed.

SETUP MENU CHART

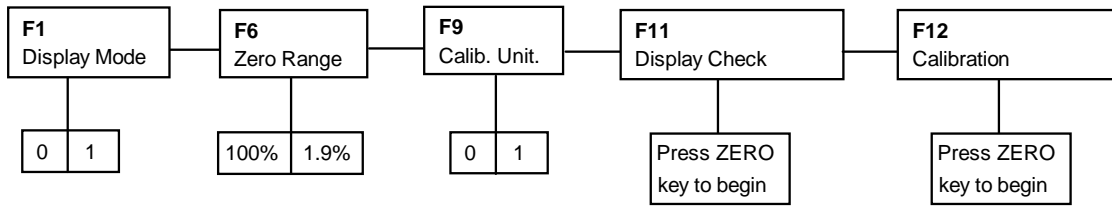

SETUP MENU DESCRIPTIONS

NAME/CODE	DESCRIPTION	CODE/VALUE
F1 Display Mode	Selects display mode for the scale. "0" = Non-NTEP mode "1" = NTEP mode	0√ 1
F6 Zero Range	Selects the range within which the scale may be zeroed. Note that the scale must be in standstill to zero the scale.	100%√ 1.9%
F9 Calibration Unit	Selects the primary base unit to be used in the calibration process. Also the default unit for normal operation. "0" = primary unit is lb. "1" = primary unit is in kg.	0√ 1
F11 Display Check	Actuates the function that illuminates all digit segments, decimal points, and LCD annunciators in a test sequence. Pressing the ZERO key to scroll down one level begins the test sequence.	Press ZERO key to begin sequence
F12 Calibration	Places scale into the calibration routine. Scrolling down with the ZERO key one level begins the procedure.	Press ZERO key to begin sequence
F13 Factory Reset	This sub-menu will reset all parameters in the "F" and "A" menus to the default settings. USE WITH CAUTION!!!!	Press the ZERO key twice to execute.

NOTE: Sub-menu F13 restores all parameters in the User ("A") Menu and Setup ("F") Menu to the factory default settings. PLEASE USE CAREFULLY AS YOU MAY LOOSE VITAL SETUP PARAMETERS!!!

To place the unit back into the Normal Operating mode:

1. With the scale on or off, toggle the Calibration Switch back to its original position. Turn the scale back on without pressing any keys.
2. The display will go through a digit check, and then settle into Normal Operating mode. All front panel keys will now return to their normal mode of operation.

CALIBRATION

Your PC-150 shipping scale is ready to use right out of the box. There is no need to calibrate the scale unless you feel that the scale has become inaccurate. It is a good idea to check the calibration of your scale from time to time with a precision test weight.

The scale can be calibrated by following the procedure below. The minimum test weight that can be used is 1.5 lb (0.7 kg), but 100 lb (50 kg) is the recommended test weight.

To calibrate the scale:

1. If you are already in Setup Menu Mode, scroll to "F 12" and press the **ZERO** (down) key. Otherwise, turn the scale off and set the Calibration Switch on the rear panel to the opposite position. Turn the scale back on.

The message "C 0" appears on the display briefly, followed by a value which remains on the screen. Allow a 2-3 minute warm-up period for the load cell and electronics to become thermally stable.

2. Press **ZERO** to zero the value, and then press the **NET/GROSS** key to save the zero point value. The display will momentarily prompt "C 1" for the span calibration, followed by "0.00" with one digit flashing.
3. Place the test weight on the platform.
4. Use the four directional keys to adjust the displayed value to the actual test weight value in pounds. Increase the flashing digit by pressing the **lb/kg** key. Decrease the flashing digit by pressing the **ZERO** key. The position of the flashing digit may be changed by pressing the **PRINT** key or the **TARE** key.
5. After setting the exact value of the test weight, press the **NET/GROSS** key to save the value.
6. If the calibration was successful, the display will show "ECAL" momentarily, and then freeze. Exit the Calibration mode and enter the Normal Operating Mode by positioning the Calibration Switch back to its original position.
7. If the calibration was *not* successful, one of the error messages below will appear. Take the indicated action to correct the problem, and then perform a new calibration.

"**Err0**" - The calibration test weight or the adjusted keyed-in weight is larger than full scale. Change the calibration test weight or check the keyed-in weight.

"**Err1**" - The calibration test weight or the adjusted keyed-in weight is smaller than 1% of full scale. Change the calibration test weight or check the keyed-in weight.

"**Err2**" - Check keyed-in weight with the actual weight placed on platform; could also indicate a fault with the scale.

To place the scale back into the Normal Operating mode:

1. Toggle the Calibration Switch back to its original position.
2. The display will go through a digit check, and then settle into Normal Operating mode. All front panel keys will now return to their normal mode of operation.

SPECIFICATIONS

MODEL	Non Legal-for-trade Capacity	Legal-for-trade Capacity
PC-150	0 - 5 x 0.01 lb (0 - 2 x 0.005 kg) 5 - 70 x 0.02 lb (2 - 30 x 0.01 kg) 70 - 150 x 0.05 lb (30 - 70 x 0.02 kg)	0 - 150 x 0.05 lb (0 - 70 x 0.02 kg)

CONSTRUCTION:

Base: Steel and ABS
Platform: ABS
Feet: Non-skid Hard Rubber

DISPLAY:

6 Digit, 0.6", 7-Segment Green LED

OVER CAPACITY ANNUNCIATION:

102% of Full Scale Capacity

OPERATING TEMPERATURE RANGE:

32°F to 104°F (0°C to 40°C)

PLATTER SIZE:

13" x 13" (330 mm x 330 mm)

POWER SOURCE:

Desktop Switching Adapter,
9VDC, 3A, included

WEIGHT:

Net Weight: 24.3 lb (11 kg)
Shipping Weight: 27.8 lb (12.6 kg)

COM PORTS:

RS-232C: Full duplex, DSUB9
USB: 2.0, full speed, peripheral

APPROVALS



NTEP Certified
 CC: 96-136A1



General Class III at
 3,500 divisions
 NOA: AM-5262

PHYSICAL DIMENSIONS (L x W x H)

13" x 13" x 4-1/3" or 330.2 mm x 330.x mm x 112 mm

SERIAL PORT INFORMATION

The rear panel of the PC-150 contains two serial ports:

- RS-232C
- USB 2.0, full speed, peripheral

The RS-232C port is a full duplex (bi-directional) communication port realized by a 9-pin DSUB “female” connector. Its pin-out is as follows:

Pin No.	Pin Name
2	Receive Data
3	Transmit Data
5	Signal Ground

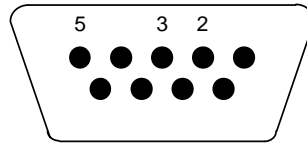

9-pin RS-232 connector (female)

Transcell's off-the-shelf cable solution for connection to a PC style COM port is our optional NMC-1 Null Modem Cable. If you prefer to fabricate your own cable instead, use the cable diagram shown below:

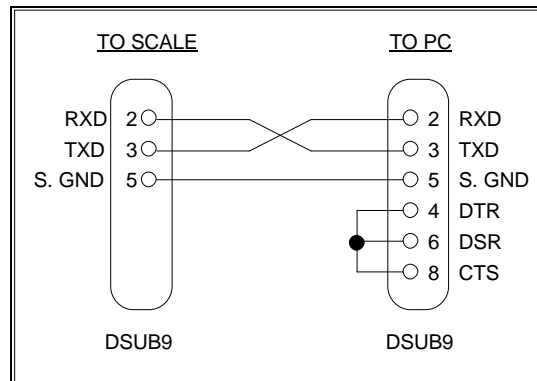

Not many computers these days come with a COM port. USB has replaced the serial COM port on most computers. The USB solution on our PC-150 uses a special driver on your PC to produce what's called a Virtual COM Port or VCP. This allows many legacy applications to work seamlessly with our scale because to them, it's just another COM port. A standard USB cable (Standard Type A to Standard Type B) will work or one can be purchased from Transcell (Model USB-1).

The SPS-70DL USB drivers are compatible with our PC-150. You can download the SPS-70DL USB drivers in the Downloads section of our website

If you are experiencing communication problems, please note the following:

Cabling – This must be 100% correct (see diagrams above)

Baud Rates, Data Bits, Parity – These parameters must match 100% on both devices

Select the proper COM port on your computer or serial device – sometimes other applications will automatically grab the first available COM port

Handshaking – Select 'None' on your application

For more detailed troubleshooting, please refer to the PC-150 Service Manual, or contact Transcell Technology Technical support at 1-847-419-9180.

ERROR CODES

CODE	MODE	MEANING / POSSIBLE SOLUTION
□□□□□□	Normal Operating Mode	A weight greater than 102% of the scale's capacity has been applied to the scale. Remove the weight from the platter. Try re-calibrating the scale if this doesn't solve the problem. Otherwise, possible load cell damage due to overloading.
- - - - -	Normal Operating Mode	Underrange condition. Platter has been removed. Re-install platter. Try re-calibrating the scale if this doesn't solve the problem. Otherwise, possible load cell damage due to shock loading.
- HI -	Warmup Mode	The scale has been turned on with a weight already present on the platter. Remove the weight and then press the ZERO key if necessary. Try re-calibrating the scale if this doesn't solve the problem. Otherwise, possible load cell damage due to overloading.
- LO -	Warmup Mode	The scale has been turned on without the platter installed. Install the platter and then press the ZERO key if necessary. Try re-calibrating the scale if this doesn't solve the problem. Otherwise, possible load cell damage due to shock loading.
Err 0	Calibration Mode	Keyed-in weight value in Calibration Mode is less than 1.5 lb (0.7 kg). Use a larger test weight or re-adjust value.
Err 1	Calibration Mode	Keyed-in weight value in Calibration Mode is larger than 150 lb (70 kg). Use a smaller test weight or re-adjust value.
Err 2	Calibration Mode	Internal resolution is not high enough to process keyed-in weight value in Calibration Mode. Verify test weight and value.
Err 3	All Modes	Diagnostics check error - EEPROM Read
Err 4	All Modes	Diagnostics check error - EEPROM Write

WARRANTY AND SERVICE INFORMATION

Transcell warrants that the PC-150 Digital Bench Scale will conform to written specifications, drawings, and other descriptions made by the manufacturer, including any modifications thereof. Transcell warrants the goods against faulty workmanship and defective materials. If any goods fail to conform to these warranties, Transcell will, as its sole and exclusive liability hereunder, repair or replace such goods if they are returned within the following warranty period:

Twelve (12) months from date of shipment from manufacturer.

These warranties are made upon the express condition that:

- 1) Transcell Technology, Inc. is given prompt written notice upon discovery by Buyer of such non-conformity, with a detailed explanation of the alleged deficiencies;
- 2) Such goods are returned to the Transcell at the expense of the Buyer;
- 3) Examination of such goods by Transcell discloses that the nonconformity actually exists and was not caused by accident, misuse, neglect, alteration, improper installation improper or unauthorized repair, or improper testing, and
- 4) Such goods have not been modified, altered, or changed by any person other than the Transcell or its duly authorized repair agents.
- 5) Transcell Technology, Inc. will have a reasonable time to repair or replace such goods.

THESE WARRANTIES EXCLUDE ALL OTHER WARRANTIES, EXPRESS OR IMPLIED, ORAL OR WRITTEN, INCLUDING WITHOUT LIMITATION WARRANTIES OF MERCHANTABILITY OR FITNESS FOR A PARTICULAR PURPOSE. TRANSCCELL WILL NOT IN ANY EVENT BE LIABLE FOR INCIDENTAL OR CONSEQUENTIAL DAMAGES.

IN ACCEPTING THIS WARRANTY, THE PURCHASER OR BUYER AGREES TO WAIVE ANY AND ALL OTHER CLAIMS FOR RIGHT TO WARRANTY FROM TRANSCCELL TECHNOLOGY, INC. SHOULD THE SELLER BE OTHER THAN TRANSCCELL TECHNOLOGY, INC., THE BUYER AGREES TO LOOK ONLY TO THE SELLER FOR WARRANTY CLAIM OR CLAIMS.

No terms, conditions, understanding, or agreements purporting to modify the terms of this warranty shall have any legal effect unless made in writing and signed by a corporate officer of the Transcell.

©Transcell Technology, Inc. 2010. All rights reserved.

The information contained herein is the property of Transcell Technology and is supplied without liability for errors or omissions. No part may be reproduced or used except as authorized by contract or other written permission. The copyright and the foregoing restriction on reproduction and use extend to all media in which the information may be embodied.

Contents subject to change without notice.
