

PPC-300WP

Operation Manual

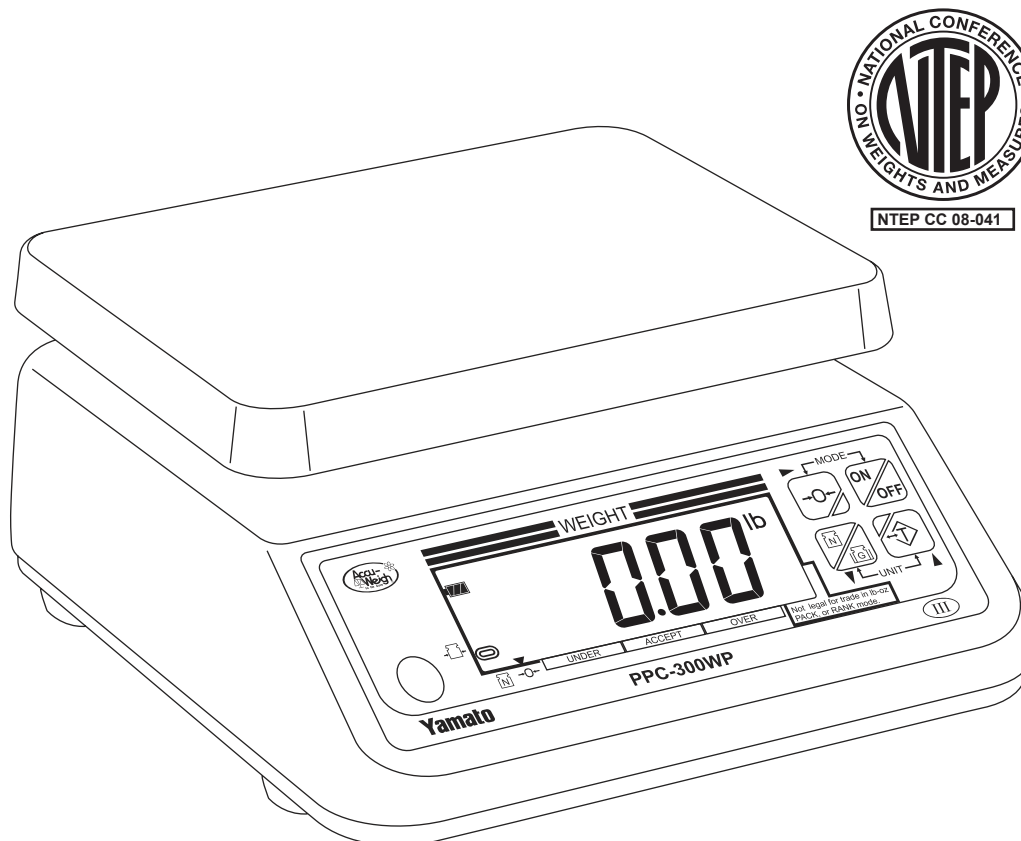

Yamato
www.YamatoCorp.com

YAMATO CORPORATION
1775 S. Murray Blvd.
Colorado Springs, CO 80916 USA
Tel (719) 591-1500 Fax (719) 591-1045

YAMATO TECH CORPORATION
#112-19425 Langley By-Pass
Surrey, B.C. V3S 6K1 Canada
Tel (604) 533-2338 Fax (604) 533-0827

Table of Contents

| | | |
|------|-------------------------------|----|
| I. | Introduction | 1 |
| | Conventions | 1 |
| | Safety Precautions | 1 |
| II. | Description | 4 |
| | Name and Function of Parts | 4 |
| | Specifications | 5 |
| III. | Setup | 7 |
| | Installing the Batteries | 7 |
| | Installing the AC Adaptor | 7 |
| | Leveling the Scale | 7 |
| | Cleaning the Lower Diaphragm | 8 |
| IV. | Using the Scale | 9 |
| | Turning the Scale On and Off | 9 |
| | Zero the Scale | 9 |
| | Selecting Units | 9 |
| | Checking the Battery Level | 9 |
| | Basic Weighing | 9 |
| | Net Weighing - Tare Operation | 10 |
| | Batch Weighing | 11 |
| | Selectable Functions | 12 |
| | Packing Function | 13 |
| | Checkweighing Function | 16 |
| | Grading Function | 19 |
| V. | User Parameters | 22 |
| VI. | Troubleshooting | 24 |

I Introduction

Welcome to your new Yamato scale. This operation manual provides you with instructions on how to setup, use and care for the PPC-300WP. More advanced technical specifications, calibration instructions, configuration information and a parts list are available in the PPC-300WP Technical Manual.

Before using the scale, carefully read, understand, and follow the “Safety Precautions” described in this manual. Observe the advice given in the “Directions for Use” section to ensure proper operation. Keep this operation manual handy for reference over the entire life of the scale. The contents of this manual are subject to change without notice.

Conventions

The following conventions are used in this manual.

 **Danger** : Warns users about a procedure that could result in serious injury or death if not performed properly or if ignored.

 **Warning** : Warns users about a procedure that could result in injury or property damage if not performed properly or if ignored.

 **Caution** : Warns users about a procedure that could result in minor injury or damage to the scale if not performed properly or if ignored.

 : Indicates an action that must never be performed.

 : Indicates an action that must always be performed.

Note : Statements that provide additional information.

Safety Precautions

Danger - To Avoid Electric Shock

 Do not step on, or place heavy or edged objects on the AC adapter cord.
Do not disconnect the AC adapter by pulling on the cord. Connect and disconnect the AC adapter by holding the plastic body of the AC adapter.
Do not connect or disconnect the AC adapter while the adapter body, cord, or your hands are wet.
Do not spray water onto or submerge the scale when using an AC adapter. Removal of the battery cover seal for the AC adapter cord voids the water-tight seal of the scale.

Danger - To Avoid Explosion and Fire

 This scale is not an explosion-proof model. Do not use the scale in an atmosphere containing flammable gases or explosive fumes. A fire or an explosion can result.

I Introduction

Danger - To Avoid Fire and Electric Shock



Do not operate the scale if there is smoke or a burnt smell coming from the scale. Remove the batteries or unplug the AC adaptor immediately. After making sure there is no danger, consult your dealer. Never try to repair the scale yourself!

Warning



Do not step or sit on the scale. This will damage the scale and you could be injured. Do not insert your fingers into gaps or holes in the scale. You could be injured. If the LCD display should break, do not touch the liquid or broken glass from the LCD. The liquid is toxic if ingested, and the glass can be sharp. Be especially careful around children. Do not short, submerge or heat the batteries. They could burst and leak corrosive chemicals.



Place the item to be weighed in the center of the platform. Items placed on the edge of the platform may fall off and cause injury or damage. When weighing a heavy, large or unbalanced item, make sure the item is stable on the platform to prevent injury or damage. Place the scale on a stable, level surface to prevent injury or damage.

Caution



Do not lift or carry the scale by the platform. This can damage the scale. Carry and lift the scale with both hands using the hand grips on the bottom of the scale. Do not twist the platform. This can damage the scale. Do not shock load the scale. This can damage the scale. Do not push the indicator or keys with sharp objects. They can puncture or break the switch membrane panel, voiding the watertight seal. This scale is a sensitive weighing instrument, avoid physical shocks. If you drop something on the scale, overload the scale, step on the platform, or drop the scale, the scale may be damaged and lose accuracy. Never open the housing. The electronics may be damaged and you may be injured by sharp edges on the internal parts. Do not open the battery lid in extremely dusty environments. Dust could stick to the battery lid seal and prevent a watertight seal when the lid is closed. Do not place the scale upside down. This could damage the load cell. Do not lick or place batteries in the mouth.



If the housing is opened or screws loosened, the water-tight seal must be tested after reassembly to ensure no leaks are present before exposing the scale to liquids. Use the specified adapter or batteries, and choose a suitable environment. If you do not, the weight readings may be inaccurate and the scale may be damaged. When the low battery indicator appears, replace all four of the batteries. When installing the batteries, install them according to the polarity markings in the case (+, -). If the scale will not be used for a long period, remove the batteries. Do not mix alkaline and manganese batteries. After changing batteries, wipe the battery lid seal with a damp cloth to remove foreign matter that could prevent a watertight seal. Fasten the battery lid tightly. Keep batteries out of the reach of small children. Dispose of batteries in accordance with all applicable regulations.

I Introduction

To keep the scale working efficiently



The PPC-300WP is rated IP68 (waterproof) when it has been closed by Yamato authorized technicians using Yamato approved equipment and procedures. When closed by other technicians or methods, the PPC-300WP is only rated IP65 (washdown).

Do not place the scale in an area exposed to direct sunlight, wind currents, fire or steam, otherwise, the measurements will not be accurate.

Do not place the scale near machines that create vibrations or electromagnetic disturbance, such as microwave ovens, portable phones, or large motors. This will affect the accuracy.

The operating environment is a work temperature range of -10°C to $+40^{\circ}\text{C}$ (14°F to 104°F) and a humidity range of 30% RH to 85% RH. Do not subject the scale to sudden temperature changes. Allow the scale to adjust to new temperatures before use. For example, a 10°C change in temperature will require approximately 5 minutes before thermal equilibrium is reached.

If the scale is sealed as legal for trade, do not break the seal. If you break the seal, the scale will not be considered legal for trade. In this case, contact your dealer.

Do not disassemble or modify the scale, you will void the warranty. Modified scales may not be legal for trade and may lose their IP rating.



Remove the batteries when using the AC adapter. The scale will continue to draw power from the batteries, if they are installed, even with an AC adapter connected.

Place the scale on a flat stable surface that will support the scale and the load.

Use only parts and modifications specified by Yamato. Yamato cannot be held responsible for problems caused by modifications or parts not specified by Yamato.

If dust or foreign matter becomes lodged in the lower diaphragm chamber, remove it following the instructions in Cleaning the Lower Diaphragm.

End of life disposal



Dispose of all electronic equipment in accordance with all applicable laws and regulations.

Cleaning



If the scale becomes dirty, clean it with a soft cloth and clean water. For stubborn stains, apply a little neutral detergent and then wipe the scale with a dry cloth.

When sanitizing the stainless steel platform and platform support with hypochlorous acid; use a concentration of 200 ppm or less, soak for 5 to 10 minutes, rinse with clean water and dry with a clean cloth.

When sanitizing the scale body with hypochlorous acid; spray the scale with the hypochlorous acid solution, rinse with clean water and dry with a clean cloth.

When cleaning the scale with an alcohol solution; use a concentration of 80% or less, rinse all plastic parts and the overlay with clean water and dry with a clean cloth.

When cleaning the scale with mild detergent; place the detergent on a sponge or cloth, use the sponge or cloth to clean the scale, rinse with clean water and dry with a clean cloth.



Do not submerge the scale body in liquid to clean it. This will prevent deterioration of some of the plastic components.

Do not use abrasive cleaners, thinner, benzene, boiling water or cleaning implements (scrub brushes, scourers, etc.) which may damage the scale body and overlay, or cause discoloration.

II Description

Name and Function of Parts

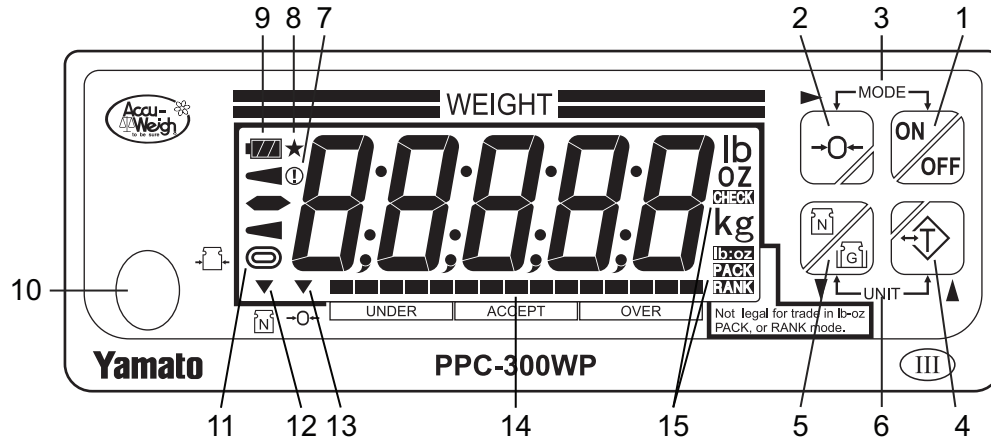

- | | |
|------------------------------|---|
| 1) ON/OFF Key | Press to turn the power on or to enter function mode. Hold to turn power off. |
| 2) Zero Key | Press to zero the display, select a digit, select the next parameter, or store a setting. Simultaneously press the Zero and Tare keys to enter user parameter mode. |
| 3) Mode Toggle | Press the ON/OFF and Zero keys simultaneously to toggle between function and normal weighing modes. |
| 4) Tare Key | Press to tare off the current load or to increment a digit. Simultaneously press the Zero and Tare keys to enter user parameter mode. |
| 5) Net/Gross Key | Press to toggle between net and gross weight readings if a tare is entered, or to decrement a digit. |
| 6) Unit Toggle | Press the Net/Gross and Tare keys simultaneously to toggle through the available weight units. |
| 7) User Parameter Mode | Indicates that the scale is in user parameter mode. |
| 8) Test Mode | Indicates that the scale is in test mode. |
| 9) Battery Status | Indicates approximate remaining battery capacity in thirds. |
| 10) Bubble Level | Use to level the scale. |
| 11) Stable Indicator | Indicates the weight reading has stabilized. |
| 12) Net Weight Indicator | Indicates the displayed weight is a net weight. |
| 13) Center of Zero Indicator | Indicates the scale is at zero gross load. |
| 14) Bar Chart | Indicates relationship between load and desired weight. The exact meaning depends on the function mode in use. |
| 15) Function Modes | CHECK - The scale is in Checkweighing function mode. PACK - The scale is in Packing function mode. RANK - The scale is in Grading function mode. |

II Description

Name and Function of Parts

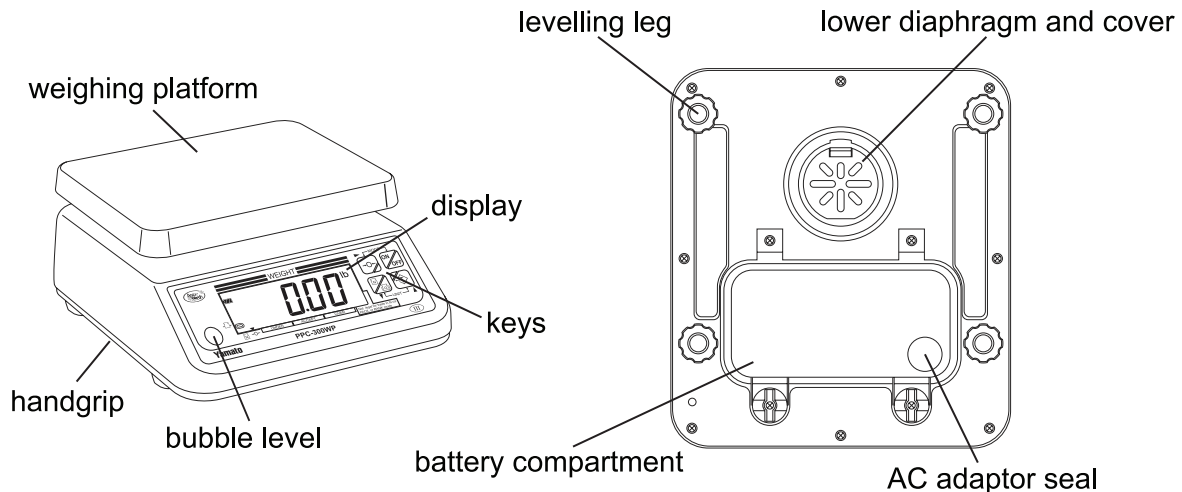

Specifications

Weighing system: Strain-gauge load cell
 Platform: 9.1" x 7.9" (232 x 202 mm), stainless steel
 Capacities and divisions:

| Kilogram | Pound | Ounce | Pound-Ounce* | Max. Tare |
|------------------|-------------------|-----------------|----------------|-----------|
| 2 kg x 0.001 kg | 4.4 lb x 0.002 lb | 80 oz x 0.05 oz | 5 lb x 0.05 oz | Capacity |
| 4 kg x 0.002 kg | 10 lb x 0.005 lb | 160 oz x 0.1 oz | 10 lb x 0.1 oz | Capacity |
| 10 kg x 0.005 kg | 22 lb x 0.01 lb | 352 oz x 0.2 oz | 22 lb x 0.2 oz | Capacity |
| 20 kg x 0.01 kg | 44 lb x 0.02 lb | 704 oz x 0.5 oz | 44 lb x 0.5 oz | Capacity |

* Combined units, such as pound-ounce, are not legal-for-trade.

Weight display: PPC-300WP - single display
 Type: 7 segment LCD
 Character size, etc.: 0.5" (13.5 mm) (W) x 1.2" (30 mm) (H), 5 digits
 Functions: One touch tare, battery charge indicator, auto-off timer, and check-weighing, packing and grading functions
 Housing: Upper - 304 Stainless Steel
 Lower - ABS resin
 Enclosure Rating: IP68 when sealed by Yamato authorized technicians, IP65 otherwise.
 Optional equipment: AC adaptor (use voids watertight seal)
 Power supply: 6 VDC - four "D" size batteries or optional AC adaptor
 Consumption: 0.07 W (max.)
 Battery life: ~ 1400 hours of continuous use with alkaline batteries
 Operating temperature: 14°F to 104°F (-10°C to 40°C)
 Operating humidity: 30% to 80% relative humidity (no condensation)
 Weight: 3.7 kg

II Description

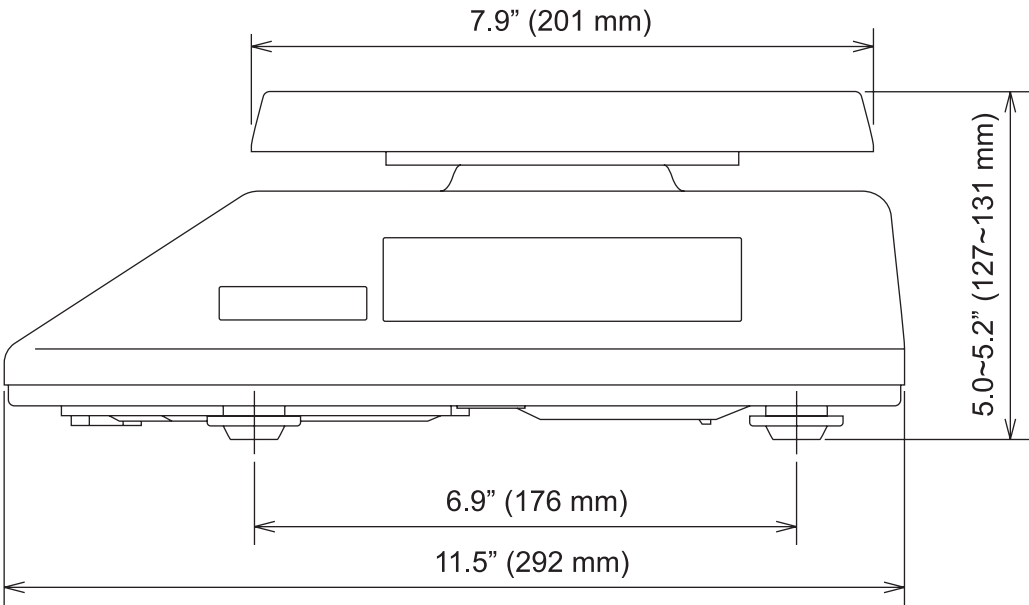
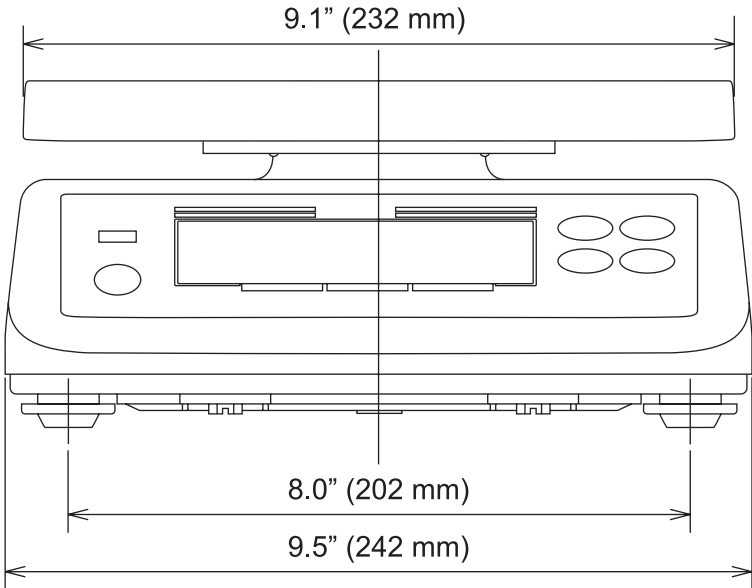

Specifications

Dimensions:



III Setup

Caution

-  Place the scale on its side to access the undercarriage.
-  Do not turn the scale upside down. This could damage the load cell.
Do not use the AC adapter when batteries are installed in the scale.

Installing the Batteries

Remove the stainless steel platform cover. Gently and carefully turn the scale on its side. Ensure the surface around the battery cover is dry and free of dust. Do not allow water or dust to enter the battery compartment. Turn the two battery cover locks counterclockwise 90° and remove the cover. Install the four alkaline "D" cell batteries according to the polarity markings on the battery holder. If you reverse the polarity of the batteries, the scale could be damaged. Ensure that the battery cover seal is clean and free of any obstructions that may cause a leak. Replace the battery cover and turn the two locks clockwise 90° until you hear them click into place. Place the scale on its feet.

Installing the AC Adaptor

-  **Caution** - Removing the battery lid adhesive sealing tape voids the watertight seal of the scale! Use of the AC adaptor is not recommended if the scale is to be exposed to water or to high levels of dust.

Use only the AC adaptor specified for use with this scale. Using the wrong adaptor can damage the scale or cause inaccurate readings. Gently and carefully turn the scale on its side. Open the battery cover and remove any batteries that are installed. The scale will continue to draw power from the batteries, if they are installed, even with an AC adaptor connected. Remove the sealing tape that is on the battery cover. Thread the AC adaptor plug through the exposed hole in the battery cover and firmly connect it to the AC adaptor jack in the battery compartment. Securely close the battery cover taking care not to catch the adaptor cord between the lid and the seal. Place the scale on its feet.

Leveling the Scale

Place the scale on a vibration free, flat, level surface that can bear the weight of the scale and any load that may be placed on it. Observe the bubble level indicator on the left side of the display. The bubble should be in the center of the circle. Adjust the trim by turning the feet in or out to lower or raise the corner of the scale the foot is on until the bubble is centered in the level indicator. If the scale is not level, the readings may not be accurate.

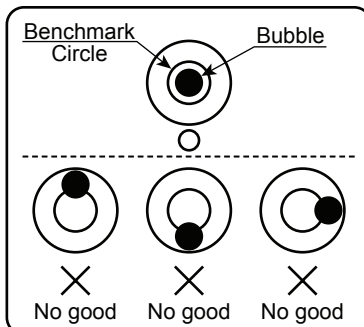

III Setup



Caution



Place the scale on its side to access the undercarriage.



Do not turn the scale upside down. This could damage the load cell.

Do not puncture or tear the lower diaphragm. This will void the watertight seal.



Cleaning the Lower Diaphragm

It will be necessary to clean out the lower diaphragm chamber if the scale is used in an extremely dust environment, or an environment with foreign matter that may become lodged in the chamber. Objects in the lower diaphragm chamber can interfere with the load cell and cause inaccurate readings.

Remove the stainless steel platform cover. Gently and carefully turn the scale on its side. Wipe away any foreign matter or liquid in the vicinity of the diaphragm cover. Press the tab on the diaphragm cover and remove the cover. Gently remove any built up dust or foreign matter in the lower diaphragm chamber with your fingers, taking care not to tear or puncture the diaphragm. Replace the lower diaphragm cover.

IV Using the Scale



Turning the Scale On and Off

Remove everything from the weighing platform and press the  key to turn the scale on. The display will briefly flash all segments of the LCD. After approximately five seconds, the display will stop flashing and automatically set to zero. Press the  key for about three seconds to turn the scale off.

Zero the Scale



If a weight value is displayed when the platform is empty, press the  key to zero the scale while the weight indication is stable "0.00". If the weight offset is greater than the push-button zero range, about 56 divisions, then the scale will indicate "---H". If this happens, then turn the scale off and back on while the platform is empty to return to a zero indication.

Changing Units

To switch between kilogram, pound, ounce and pound-ounce units; press the  and  keys at the same time.

Checking the Battery Level

The battery status indicator shows the approximate life remaining in the batteries as follows:

-  2/3 to full charge remaining.
-  1/3 to 2/3 charge remaining.
-  Less than 1/3 charge remaining.

-batt- Battery charge is too low. Replace all four "D" batteries observing the polarity markings.

Basic Weighing

1. Begin with nothing on the weighing platform, the display reading zero, and the center of zero and stable indicators lit.
2. Place the items to be weighed on the weighing platform and wait for the stable indication. The weight displayed is the gross weight.

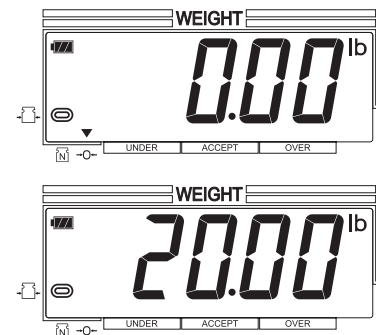





IV Using the Scale

Net Weighing - Tare Operation

Net weighing displays the weight of an item without the weight of its container. The weight of the container is tared off.

Caution

 The total gross weight should never exceed the capacity of the scale. This can damage the load cell.

1. Begin with nothing on the weighing platform, the display reading zero, and the center of zero and stable indicators lit.
2. Place an empty container on the weighing platform and wait for the stable indication.
3. Press the  key. The weight of the container will be subtracted automatically and the net weight indicator will display.
4. Place the items to be weighed in the container. The weight displayed will be the net weight of the items.
5. To display the gross weight, press the  key. The net weight indicator will no longer display, and the displayed weight will be the gross weight of the container and the items. Press the  key again to return to the net weight.
6. To return to gross weighing mode, remove all items from the weighing platform, wait for the stable indication, and press the  key.

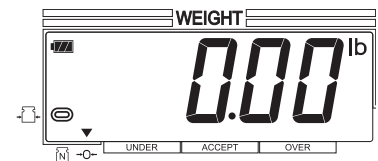
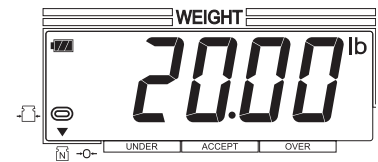
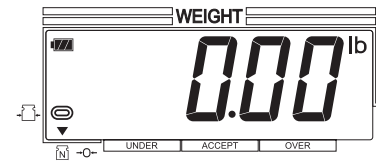
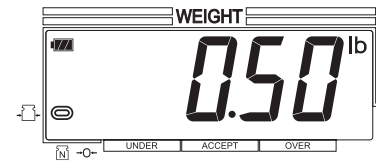
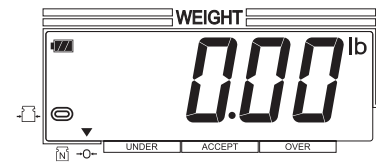







IV Using the Scale

Batch Weighing

Batch weighing displays the weight of several different combined items in succession. An example is weighing each of the different ingredients in a pizza.

Caution

 The total gross weight should never exceed the capacity of the scale. This can damage the load cell.

1. Begin with nothing on the weighing platform, the display reading zero, and the center of zero and stable indicators lit.
2. Place an empty container on the weighing platform and wait for the stable indication.
3. Press the  key. The weight of the container will be subtracted automatically, the net weight indicator will display, and the scale will read zero.
4. Add the first item to be weighed in the container until the desired weight is reached.
5. Press the  key to return to net zero. Add the second item to be weighed in the container until the desired weight is reached.
6. Press the  key to return to net zero. Continue adding items and taring them off until all the desired items have been added to the container. Press the  key at any time to toggle between the total gross weight and the current net weight.
7. Remove the container and all items from the weighing platform, wait for the stable indication, and then press the  key to reset the scale to zero.

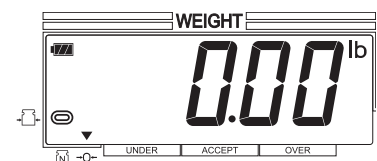
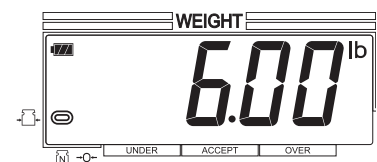
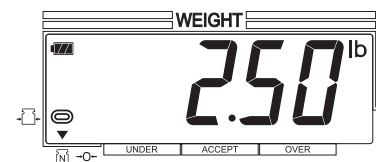
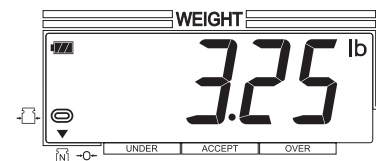
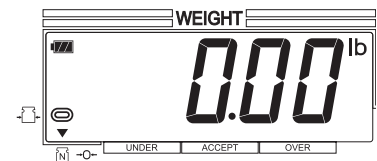
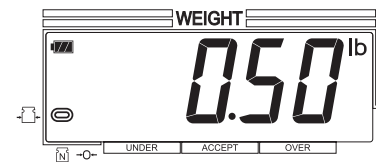
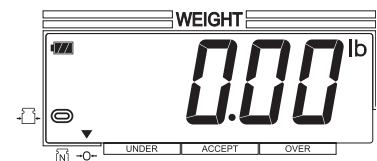

IV Using the Scale

Selectable Functions

The PPC-300 family of scales offer three selectable functions to assist you with your weighing needs. These functions are packing, checkweighing and grading. Each of these functions are programmable by the operator to give you the flexibility to adapt the PPC-300 to your processes. User setup parameter 01 controls which, if any, of these functions is enabled.

Parameter 01=000

None of the functions are enabled.

Parameter 01=001

The packing function is ideal for filling containers. The numeric display indicates the weight that needs to be added or removed from the platform to reach the target weight. The bar chart gives a graphical representation of the loaded weight in relationship to the target weight for quick reference. Up to 99 different setups can be stored for later recall. Available options include a flashing indication to announce an acceptable, unacceptable, under, or over weight condition; and an auto-tare feature that automatically tares off the container weight at the beginning of each weighment. The packing function is not legal for trade.

Parameter 01=002

The checkweighing function uses a lower limit and upper limit to establish an acceptable weight range for portioning, quality control and filling while displaying the weight loaded on the platform. The bar chart gives a graphical representation of the status of the loaded weight in relationship to the upper and lower limits for quick reference. Up to 99 different setups can be stored for later recall. An optional flashing indication announces an acceptable, unacceptable, under, or over weight condition.

Parameter 01=003

The grading function allows you to defined up to 15 continuous weight grades and displays the grade of the current load. This facilitates quick, error free sorting by the operator without a need to consult or memorize grade charts. Anywhere from 12 to 66 different setups can be store for later recall, depending on the number of grades within each setup. Available options include a flashing indication to announce a weight above the minimum grade, and a stability function that lets you choose to have a real time grade display or to require a stable reading before the grade is displayed. The grading function is not legal for trade.







More details on each of these functions and setup examples are available on the following pages.

IV Using the Scale

Packing Function

The packing function is ideal for filling containers. The numeric display indicates the weight that needs to be added or removed from the platform to reach the target weight. The bar chart gives a graphical representation of the loaded weight in relationship to the target weight for quick reference. Up to 99 different setups can be stored for later recall. Available options include a flashing indication to announce an acceptable, unacceptable, under, or over weight condition; and an auto-tare feature that automatically tares off the container weight at the beginning of each weighment. The packing function is not legal for trade.

Enable

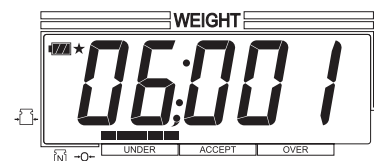
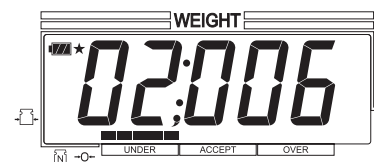
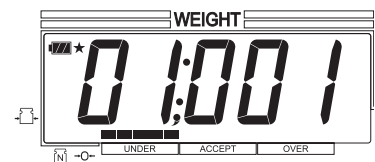
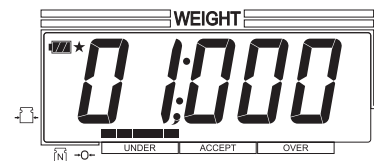

1. To enable the packing function, press the  and  keys at the same time. The yellow tabs on these keys are reminders of how to enter user setup mode. You are now in user setup mode with parameter 01 displayed.
2. Use the  and  keys to change the parameter value to 001. The down and up arrows next to these keys indicate that they decrease and increase, respectively, the displayed value.
3. To store any changes made to this parameter and to advance to the next parameter, press the  key. The right arrow next to this key indicates that it advances the display to the next parameter.
4. If you wish to set the automatic tare, advance to parameter 06.
 - 000 disables the automatic tare.
 - 001 enables the automatic tare.
 Press the  key to save any changes and advance to the next parameter.

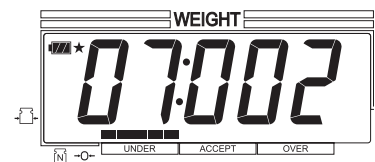

When enabled, this feature automatically tares off the first stable reading after zero. This tare is automatically cleared when the scale returns to zero.

5. If you wish to set a flashing weight reading, advance to parameter 07.
 - 000 disables the flashing feature.
 - 001 flashes when a stable weight under the acceptable weight range is loaded.
 - 002 flashes when a stable weight in the acceptable weight range is loaded.
 - 003 flashes when a stable weight over the acceptable weight range is loaded.
 - 004 flashes when a stable weight outside the acceptable weight range is loaded.
 Press the  key to save any changes and advance to the next parameter.























6. When all the parameters in user setup mode are properly configured, press the  key for about three seconds to turn the scale off. Press the  to turn the scale on. The packing function is now enabled.

IV Using the Scale

Packing Function

Once the packing function is enabled, the target weight and allowable range need to be setup.

Setup

1. With the scale on and the platform empty, press the  key for one second. The scale will indicate that it is in pack setup mode and the **PACK** indicator will flash.
2. Up to 99 different configurations can be stored in memory. Initially, the scale will display configuration 01. Use the  and  keys to select the desired configuration. Example: Press the  key four times to select configuration 05.
3. Press the  key to enter the target weight setting, or (if the configuration has already been setup) press the  key to exit setup and begin weighing.
4. Use the  key to select a digit to change, and the  and  keys to decrease or increase the digit's value. Example: Press the  key three times to select the fourth digit. Press the  key once to change the digit to "1".
5. Press the  key to enter the target weight and progress to the acceptable weight range. The acceptable weight range is the value above the target weight that is acceptable. Example: For an acceptable range of 10.00 to 10.25 pounds, enter 0.25 (10.00 + 0.25 lb.)
6. Use the  key to select a digit to change, and the  and  keys to decrease or increase the digit's value. Example: Press the  key once to select the second digit. Press the  key twice to change the digit to "2". Press the  key again to select the next digit. Press the  key five times to change the digit to "5".
7. Press the  key to enter the acceptable weight range and exit setup mode. The scale will display a negative value equal to the target weight.

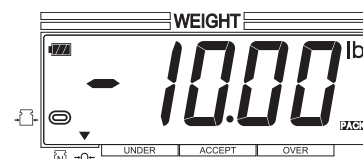
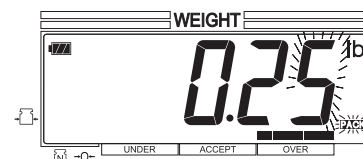
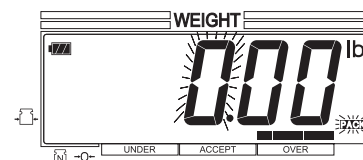
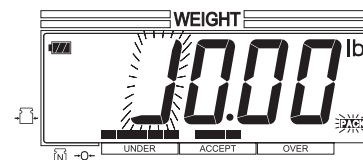
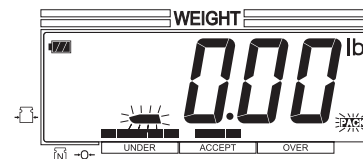
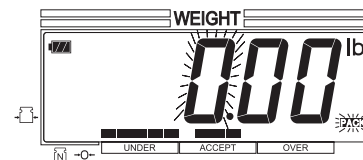
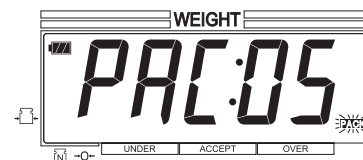
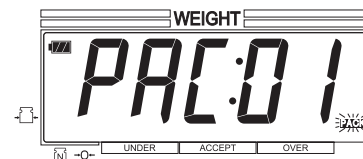



IV Using the Scale

Packing Function

This is an example of how the packing function operates once it has been enabled and setup. The set-up for this example has a target weight of 10.00 lb and a range of 0.25 lb. Automatic tare is enabled, and the scale is set to flash when a weight within the acceptable weight range is loaded.

Operation

1. The scale should display the negative value of the target weight. The **PACK**, stable and center-of-zero indicators should be displayed.
2. Place the item to be tared on the scale. The scale will automatically tare this weight off. The net weight indicator should be displayed, and the center-of-zero indicator should not.
3. Begin loading the scale with the product to be weighed. As the amount of product increases, the negative weight reading will approach zero and the length of the bar chart will increase.
4. The weight reading will begin to flash, and the bar chart will enter the ACCEPT range when the target weight is reached.
5. The weight reading will continue to flash, and the bar chart will remain in the ACCEPT range through the acceptable weight range.
6. If the acceptable weight range is exceeded, the weight reading will stop flashing, and the bar chart will enter the OVER range. Remove enough product to return to the acceptable weight range.
7. When the product weight is in the acceptable range, remove the product with the tared item. The scale will automatically clear the tare and return to the negative target weight reading. Press the  and  keys to toggle between the checkweighing function and the normal weighing mode.

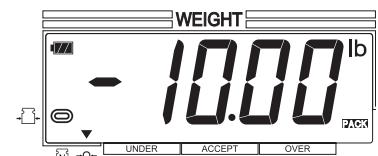
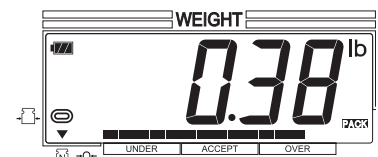
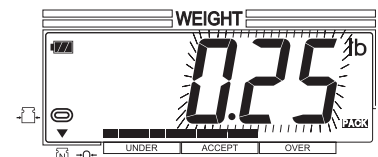
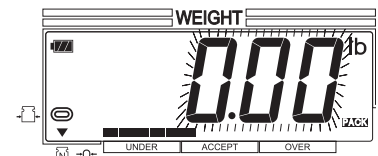
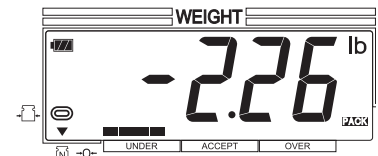
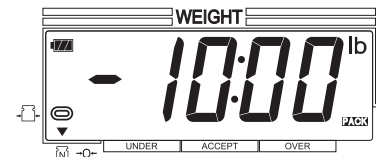
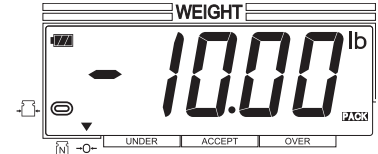





IV Using the Scale

Checkweighing Function

The checkweighing function uses a lower limit and upper limit to establish an acceptable weight range for portioning, quality control and filling while displaying the weight loaded on the platform. The bar chart gives a graphical representation of the status of the loaded weight in relationship to the upper and lower limits for quick reference. Up to 99 different setups can be stored for later recall. Available options include a flashing indication to announce an acceptable, unacceptable, under, or over weight condition.

Enable

1. To enable the checkweighing function, press the  and  keys at the same time. The yellow tabs on these keys are reminders of how to enter user setup mode. You are now in user setup mode with parameter 01 displayed.

2. Use the  and  keys to change the parameter value to 002. The down and up arrows next to these keys indicate that they decrease and increase, respectively, the displayed value.

3. To store any changes made to this parameter and to advance to the next parameter, press the  key. The right arrow next to this key indicates that it advances the display to the next parameter.

4. If you wish to set a flashing weight reading, advance to parameter 07. 000 disables the flashing feature.



001 flashes when a stable weight under the acceptable weight range is loaded.

002 flashes when a stable weight in the acceptable weight range is loaded.

003 flashes when a stable weight over the acceptable weight range is loaded.

004 flashes when a stable weight outside the acceptable weight range is loaded.

Press the  key to save any changes and advance to the next parameter.

5. When all the parameters in user setup mode are properly configured, press the  key for about three seconds to turn the scale off. Press the  to turn the scale on. The checkweighing function is now enabled.

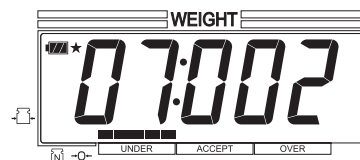
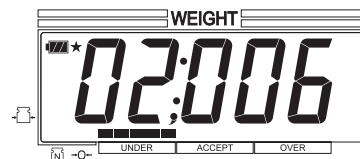
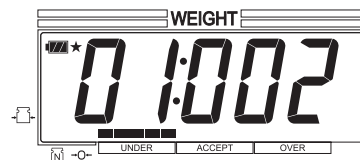
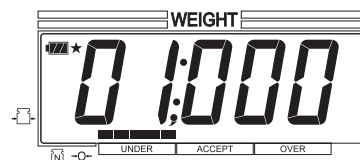























IV Using the Scale

Checkweighing Function

Once the checkweighing function is enabled, the lower limit and upper limit need to be setup.

Setup

1. With the scale on and the platform empty, press the  key for one second. The scale will indicate that it is in checkweighing setup mode and the **CHECK** indicator will flash.
2. Up to 99 different configurations can be stored in memory. Initially, the scale will display configuration 01. Use the  and  keys to select the desired configuration. Example: Press the  key four times to select configuration 05.
3. Press the  key to enter the lower limit weight setting, or (if the configuration has already been setup) press the  key to exit setup and begin weighing.
4. Use the  key to select a digit to change, and the  and  keys to decrease or increase the digit's value. Example: Press the  key three times to select the fourth digit. Press the  key once to change the digit to "1".
5. Press the  key to enter the lower limit weight and progress to the upper limit weight. The acceptable weight range is any weight between the upper and lower limits, inclusive.
6. Use the  key to select a digit to change, and the  and  keys to decrease or increase the digit's value. Example: Press the  key once to select the second digit. Press the  key twice to change the digit to "2". Press the  key again to select the next digit. Press the  key five times to change the digit to "5". Press the  one more time and then press the  key once to change the digit to "1".
7. Press the  key to enter the upper limit weight setting and exit setup mode. If either limit is set to zero, the scale will display "FAULT".

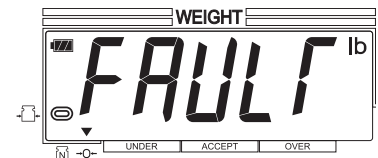
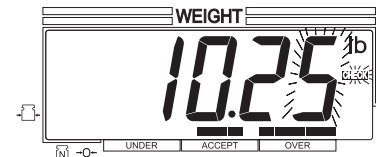
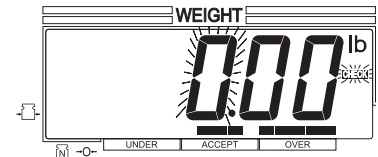
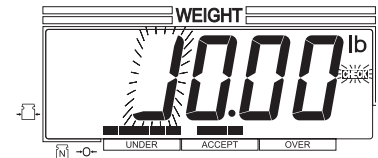
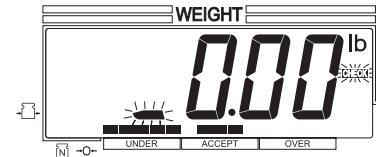
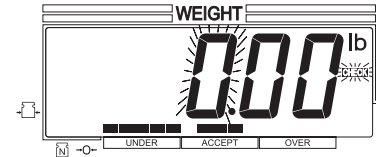
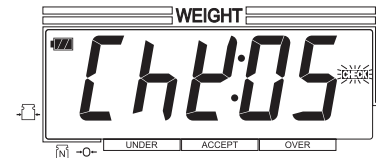
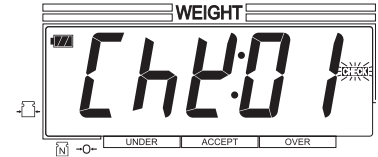





IV Using the Scale

Checkweighing Function

This is an example of how the checkweighing function operates once it has been enabled and setup. The setup for this example has a lower limit of 10.00 lb and an upper limit of 10.25 lb. The scale is set to flash when a weight within the acceptable weight range is loaded.

Operation

1. The scale should display zero. The **CHECK**, stable and center-of-zero indicators should be displayed.
2. If you wish to enter a tare, place the item on the scale platform and press the  key. The net weight indicator should be displayed, and the center-of-zero indicator should not.
3. Begin loading the scale with the product to be weighed. As the amount of product increases, so will the weight display and the length of the bar chart.
4. The weight reading will begin to flash, and the bar chart will enter the ACCEPT range when the lower limit weight is reached.
5. The weight reading will continue to flash, and the bar chart will remain in the ACCEPT range up to, and including, the upper limit weight.
6. If the upper limit weight is exceeded, the weight reading will stop flashing, and the bar chart will enter the OVER range. Remove enough product to return to an acceptable weight.
7. When the product weight acceptable, remove the product. To clear an entered tare, remove everything from the scale platform and press the  key. Press the  and  keys to toggle between the checkweighing function and the normal weighing mode.

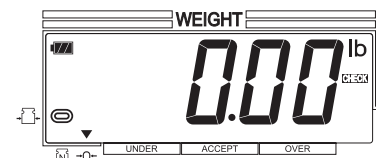
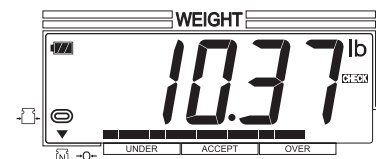
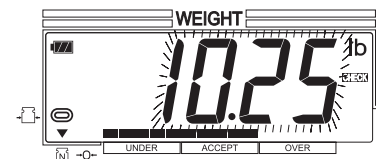
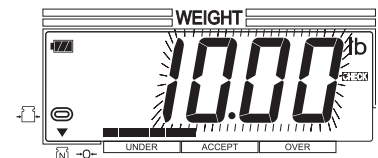
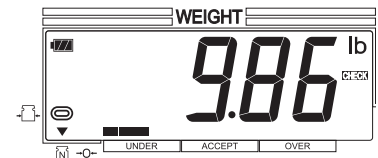
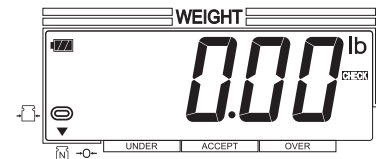
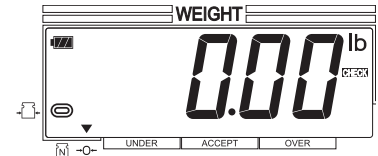



IV Using the Scale



Grading Function

The grading function allows you to defined up to 15 continuous weight grades and displays the grade of the current load. This facilitates quick, error free sorting by the operator without a need to consult or memorize grade charts. Anywhere from 12 to 66 different setups can be store for later recall, depending on the number of grades within each setup. Available options include a flashing indication to announce an acceptable weight grade, and a stability function that lets you choose to have a real time grade display or to require a stable reading before the grade is displayed. The grading function is not legal for trade.

Enable

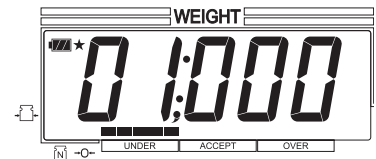
1. To enable the grading function, press the  and  keys at the same time. The yellow tabs on these keys are reminders of how to enter user setup mode. You are now in user setup mode with parameter 01 displayed.



2. Use the  and  keys to change the parameter value to 003. The down and up arrows next to these keys indicate that they decrease and increase, respectively, the displayed value.

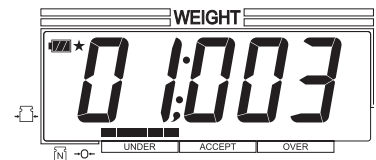

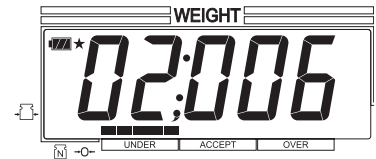

3. To store any changes made to this parameter and to advance to the next parameter, press the  key. The right arrow next to this key indicates that it advances the display to the next parameter.





4. The second parameter determines the number of grades for all setups. The greater the number of grades, the fewer setups that can be stored in the scale's memory.

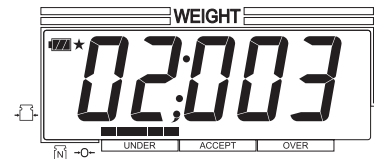

| Setting | 002 | 003 | 004 | 005 | 006 | 007 | 008 | 009 | 010 | 011 | 012 | 013 | 014 | 015 |
|-------------|-----|-----|-----|-----|-----|-----|-----|-----|-----|-----|-----|-----|-----|-----|
| # of grades | 2 | 3 | 4 | 5 | 6 | 7 | 8 | 9 | 10 | 11 | 12 | 13 | 14 | 15 |
| # of setups | 66 | 49 | 39 | 33 | 28 | 24 | 22 | 19 | 18 | 16 | 15 | 14 | 13 | 12 |

5. Use the  and  keys to set the desired value. Example: For three grades, press the  key three times to change the setting from 006 to 003.

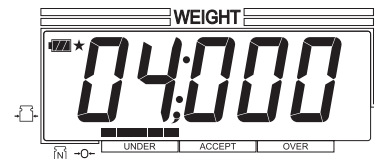

6. Press the  key twice to advance to parameter 04. If a real time-grade display is desired, set parameter 04 to 000 using the  and  keys. If a stable weight reading is required before displaying the grade, set parameter 04 to 000.



7. If you wish to set a flashing grade display, advance to parameter 07 and set it to any value other than 000. Press the  key to save any changes and advance to the next parameter. Press the  key for about three seconds to turn the scale off. Press the  to turn the scale on. The grading function is now enabled.

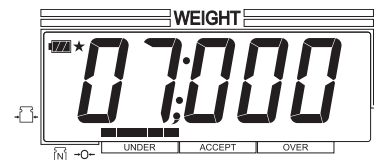

















IV Using the Scale

Grading Function

Once the grading function is enabled, the grade weights need to be setup. Each weight entered is the lowest acceptable weight for that grade. This example will setup three grades. The first is from 8.00 to 9.99 lb. The second is from 10.00 to 11.99 lb. The third is from 12.00 to 18.00 lb. Since parameter 02 is set to 003, the scale will prompt for four weights. The weights for this setup will be 8.00, 10.00, 12.00 and 18.01 lb.

Setup

1. With the scale on and the platform empty, press the  key for one second. The scale will indicate that it is in grading setup mode and the **RANK** indicator will flash.
2. Up to 66 different configurations can be stored in memory. Initially, the scale will display configuration 01. Use the  and  keys to select the desired configuration. Example: Press the  key four times to select configuration 05.
3. Press the  key to enter the grade weight setting. If the configuration is already setup, then press the  key to exit setup and begin weighing. The single bar on the bar chart indicates that this is the first grade weight.
4. Use the  key to select a digit to change, and the  and  keys to decrease or increase the digit's value. Example: Press the  key eight times to change the digit to "8". Press the  key to save this weight and advance to the next grade.
5. Enter the second grade weight. Example: Press the  key three times to select the fourth digit. Press the  key once to change the digit to "1". Press the  key to save the second weight and advance to the next grade.
6. Enter the third grade weight. Example: Use the keys to enter 12.00 lb. Press the  key to save the third weight and advance to the final weight entry.
7. Enter the final weight. This will be the lowest unacceptable weight above the final grade. Example: The final grade is from 12.00 to 18.00 lb, so enter 18.01 lb (one division above 18.00 lb). Press the  key to save the final weight and exit setup mode.

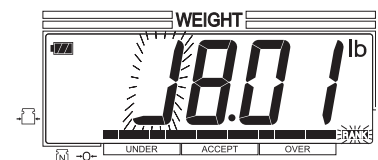
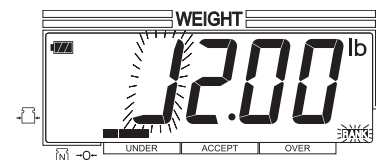
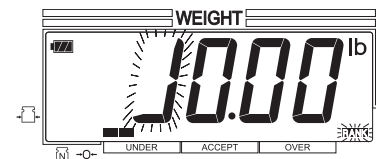
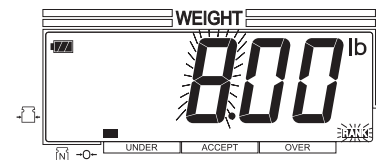
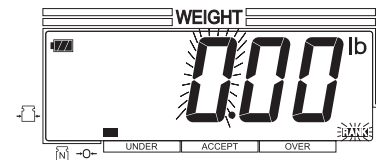
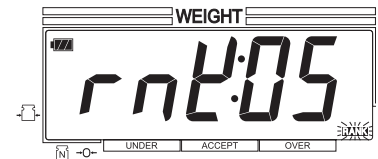
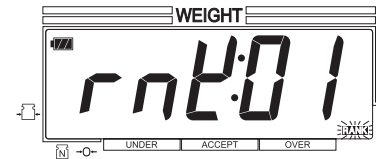





The scale will not accept a grade weight that is equal to or less than the previous grade weight.

IV Using the Scale

Grading Function

This is an example of how the grading function operates once it has been enabled and setup. The setup for this example has grades of 8.00 to 9.99 lb, 10.00 to 11.99 lb, and 12.00 to 18.00 lb. The scale is set to display real time grade values. The flashing display is not enabled.



Operation

1. The scale should display the grading setup that is active, 05 in this example. The **RANK**, stable and center-of-zero indicators should be displayed. The rightmost two digits should display underscores. This indicates that the current load is below the lowest grade.
2. If you wish to enter a tare, place the item on the scale platform and press the  key. The net weight indicator should be displayed, and the center-of-zero indicator should not.
3. Load the scale with the product to be graded. If the product falls at or above the first grade setpoint, and below the second grade setpoint, then grade 01 will be displayed.
4. If the product falls at or above the second grade setpoint, and below the third grade setpoint, then grade 02 will be displayed.
5. If the product falls at or above the third grade setpoint, and below the final grade setpoint, then grade 03 will be displayed.
6. If the product falls at or above the final grade setpoint, then two over-scores will be displayed.
7. Remove the product and any tared item. If a tare was entered, press  to clear it. Press the  and  keys to toggle between the checkweighing function and the normal weighing mode.

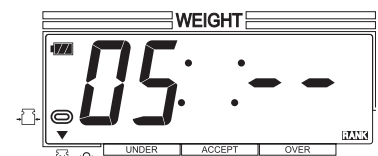
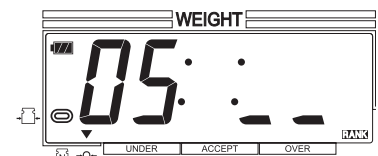
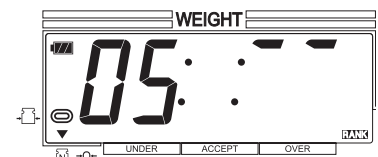
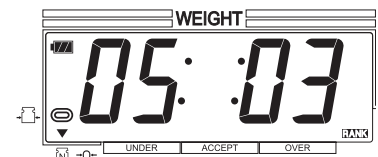
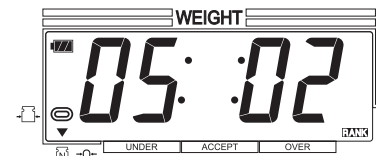
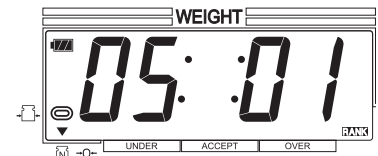
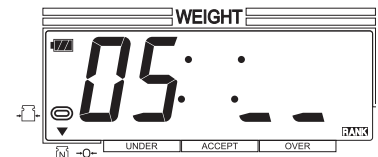
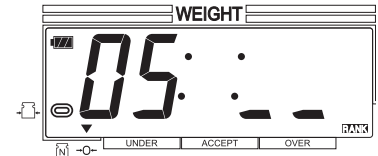





If parameter 04 is set to 001 (stable weight reading required), then the scale will display two dashes on the right until the weight reading is stable.



V User Parameters

The PPC-300 family of scales have nine functional user parameters that can be accessed by pressing the  and  keys at the same time.

| Parameter | Default | Description | Settings |
|-----------|---------|------------------------|---|
| 01 | 000 | Function selection | 000: Functions disabled. 001: Packing enabled. 002: Checkweighing enabled. 003: Grading enabled. |
| 02 | 006 | Number of grades | 000: Grading suspended. 001 - 0015: 1 - 15 grades. |
| 03 | 000 | Buzzer | 000: Disabled. 001 - 004: PPC-300WP only. |
| 04 | 000 | Grade stability | 000: Real time grade display. 001: Grade displayed at stable reading. |
| 05 | 003 | Auto-off timer | 000: Disabled. 001: After idle for 5 minutes. 002: After idle for 10 minutes. 003: After idle for 15 minutes. 004: After idle for 30 minutes. 005: After idle for 60 minutes. |
| 06 | 000 | Automatic Tare | 000: Disabled. 001: Enabled (packing function only). |
| 07 | 000 | Flashing display | 000: Disabled. 001: Flash when under weight. 002: Flash for acceptable weight. 003: Flash when over weight. 004: Flash when under or over weight. 005: Flash when buzzer sounds. |
| 08 - 19 | 000 | Inactive | 000: Do not adjust these settings |
| 22 | 000 | Vibration compensation | 000: Standard, highest response speed. 001: Increased, slower response speed. 002: Maximum, slowest response speed. |
| 23 | 001 | Units at power on | 000: kg 001: lb 002: oz 003: lb-oz |

Once in user parameter mode use the  key to select the desired parameter, then use the  and  keys to change the set value to the desired value. The arrows next to these keys indicate their function. Once the parameter value has been changed, press the  key again to save the change. After all the desired parameter changes have been made, press the  key for about three seconds to turn the scale off. Press the  to turn the scale back on. It is now ready for use with the changes in effect. Please see the following page for a more detailed explanation of each parameter.

V User Parameters

01 - Function Selection

The PPC-300 series has three user selectable weighing functions: Packing, Checkweighing, and Grading. The value of this parameter determines which, if any, of the three functions is enabled. For more information on these functions, please see section IV of this manual.

02 - Number of Grades

The grading function can be set to have 2 to 15 grades. The higher the number of grades, the fewer the number of different grading setups that can be stored in memory. Please see section IV of this manual for more information on the grading function.

| Setting | 002 | 003 | 004 | 005 | 006 | 007 | 008 | 009 | 010 | 011 | 012 | 013 | 014 | 015 |
|-------------|-----|-----|-----|-----|-----|-----|-----|-----|-----|-----|-----|-----|-----|-----|
| # of grades | 2 | 3 | 4 | 5 | 6 | 7 | 8 | 9 | 10 | 11 | 12 | 13 | 14 | 15 |
| # of setups | 66 | 49 | 39 | 33 | 28 | 24 | 22 | 19 | 18 | 16 | 15 | 14 | 13 | 12 |

03 - Buzzer

This parameter only applies to the PPC-300WP.

04 - Grade Stability

The grading function can be set to either show a real time display of the calculated grade, or to show no grade value until a stable weight reading has been achieved. If this parameter is enabled (001) then the scale will display two dashes in place of the grade value until the weight reading is stable. Then it will display the appropriate grade.

05 - Auto-off Timer

The PPC-300 series of scales can be set to automatically turn off after a specified time with no activity. This feature only operates when the scale is using batteries for power.

06 - Automatic Tare

The packing function can be set to automatically tare an initial stable weight, and to automatically clear the tare when the scale returns to zero.

07 - Flashing Display

This feature is available for the packing, checkweighing and grading functions. For the packing and checkweigh functions, this feature can be set to operate as specified in the preceding table. Any setting between 001 and 004 will cause the display in the grading function to flash when any weight above or equal to the first, lowest grade weight is detected. Setting 005 is only applicable to the PPC-300WP.

21 - Vibration Compensation







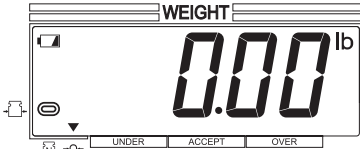
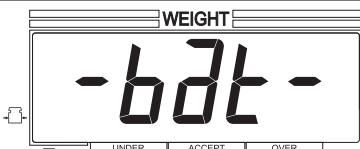
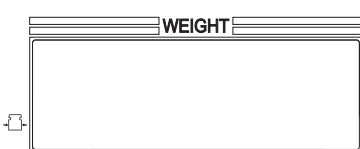
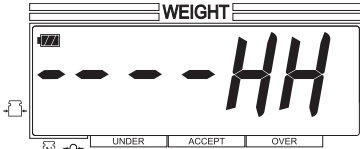

Environments that experience "noise" issues caused by external vibration can set this parameter for a more stable reading at the cost of a longer response time to calculate a stable weight.

22 - Units at Power On

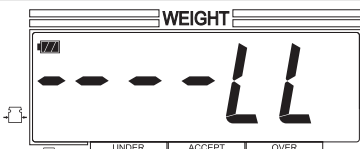

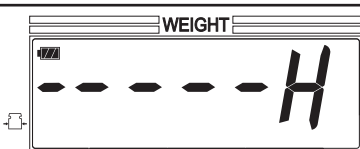
The units (kg, lb, oz, or lb-oz) that the scale will indicate when it is turned on.

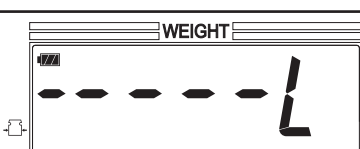
VI Troubleshooting

The scale automatically detects several errors. The following table describes the various errors that can be encountered, and provide user-level corrective actions. If these actions fail to correct the error, please contact a qualified scale technician.

| Display | Condition | Action |
|---|---|---|
|  | Low batteries. | Replace all four batteries with fresh batteries. |
|  | Exhausted batteries, scale will shut off. | Replace all four batteries with fresh batteries. |
|  | Scale will not turn on. Dead batteries or AC/DC adapter not connected. | Replace all four batteries with fresh batteries, or verify proper adapter is connected to the scale and plugged into a powered outlet. |
|  | Load over allowable limit at start up. | Remove all items from the scale platform and press the  key. |
|  | Load under allowable limit at start up. | Remove items wedged under the scale platform and press the  key. |
|  | Attempted to zero a load greater than allowed. | Remove all items from the scale platform and press the  key. |
|  | Zeroed the scale with a load on the platform, and then removed the load. | Remove all items from the scale platform and press the  key. |

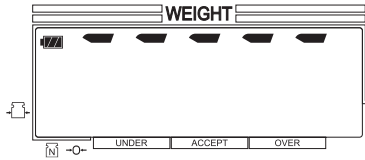
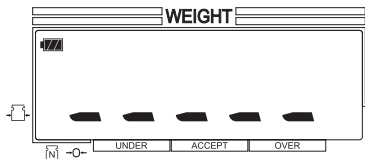
VI Troubleshooting

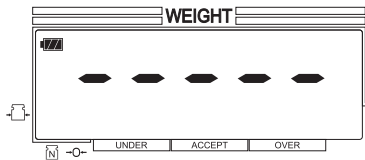
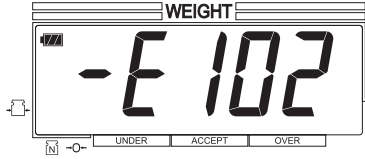
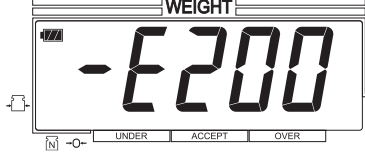
| Display | Condition | Action |
|---|--|--|
|  | Overload - there is too much weight on the scale platform. | Remove weight from the scale platform until the load is within the scale capacity. |
|  | Negative weight reading greater than five divisions. | Replace the stainless steel pan on the scale platform, if removed. Remove all items from the scale platform and press the  key. |
|  | Sensor error. | Turn the scale off, wait one minute, and then turn the scale back on. |
|  | Circuit error. | Turn the scale off, wait one minute, and then turn the scale back on. |
|  | Controller error. | Turn the scale off, wait one minute, and then turn the scale back on. |

Additional troubleshooting steps require the services of a qualified scale technician. Do not attempt to service the scale yourself.

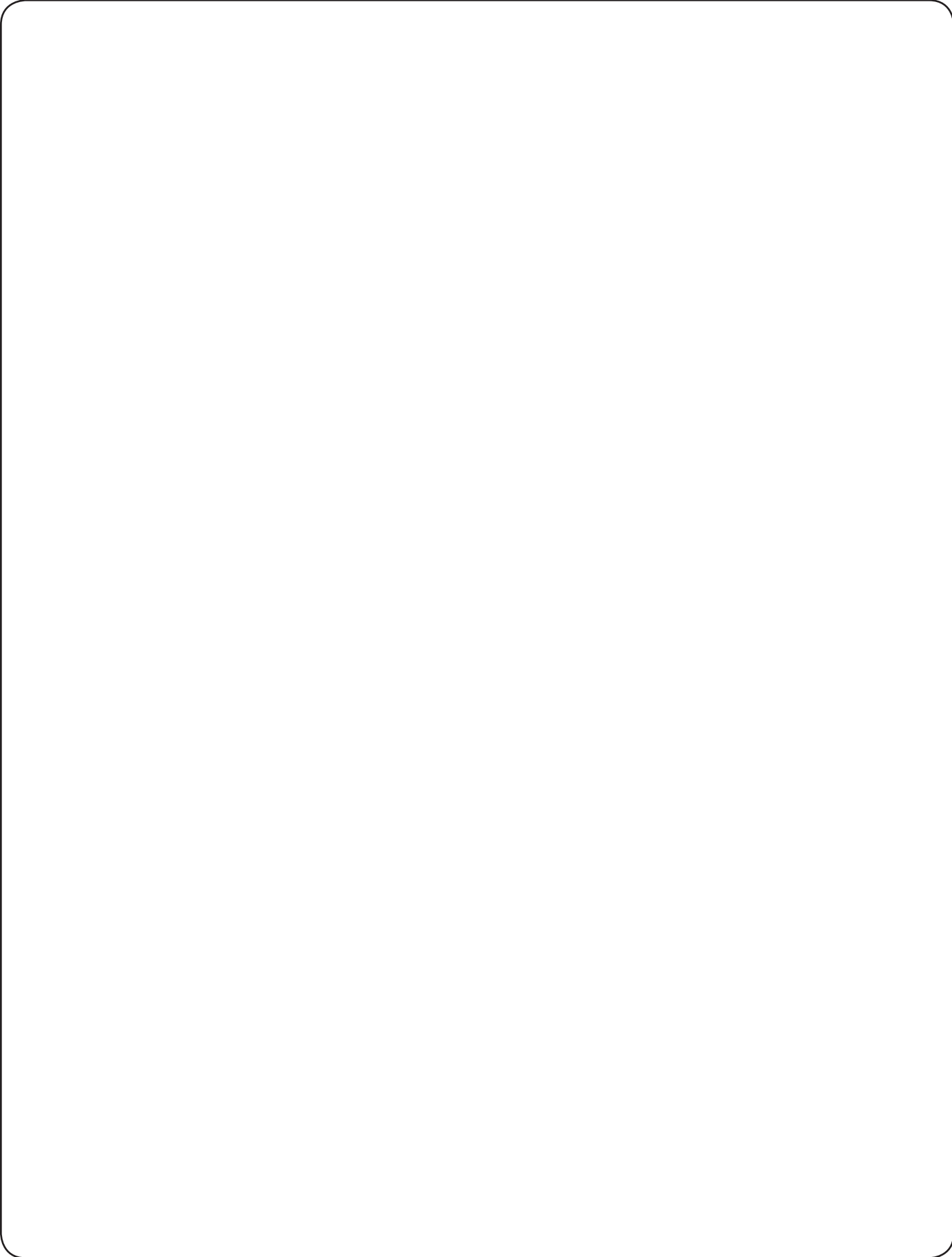



YAMATO CORPORATION
1775 S. Murray Blvd.
Colorado Springs, CO 80916 USA
Tel (719) 591-1500 Fax (719) 591-1045

YAMATO TECH CORPORATION
#112-19425 Langley By-Pass
Surrey, B.C. V3S 6K1 Canada
Tel (604) 533-2338 Fax (604) 533-0827