



Operation Manual

TVD

Multifunction Scale

V1.2







CONTENTS

1. INTRODUCTION.....	- 1 -
2. KEYS DESCRIPTION.....	- 1 -
3. DISPLAY SYMBOLS.....	- 2 -
4. POWER CONNECTION.....	- 2 -
4.1 Rechargeable battery operation.....	- 2 -
4.2 Charging the battery.....	- 2 -
5. BASIC OPERATION.....	- 3 -
5.1 Power On/Off.....	- 3 -
5.2 Zero.....	- 3 -
5.3 Tare.....	- 3 -
5.4 Select Weighing Units.....	- 3 -
5.5 Percent Weighing.....	- 3 -
5.6 Parts Counting.....	- 4 -
5.7 Tolerance checking.....	- 4 -
5.7.1 Limits setting for target weight.....	- 4 -
5.7.2 Limits setting for target quantity.....	- 5 -
5.7.3 Limits setting for target percentage.....	- 6 -
5.7.4 To set beep mode.....	- 6 -
5.7.5 To disable check weighing mode.....	- 7 -
5.8 Accumulation.....	- 7 -
5.8.1 Manual Accumulation.....	- 7 -
5.8.2 Recall Memory.....	- 7 -
5.8.3 Memory Clear.....	- 8 -
5.8.4 Automatic Accumulation.....	- 8 -
5.9 Printing.....	- 8 -
5.10 Back Light Setting.....	- 8 -
5.11 Power Auto Off.....	- 9 -
5.12 Check Internal Counts.....	- 9 -
6. SPECIFICATION.....	- 10 -
7. DIMMENSIONS(inch/mm).....	- 11 -
8.ERROR MESSAGE.....	- 11 -
9.SELECTING THE PRINTER.....	- 12 -
10. RS232 OUT PUT.....	- 12 -
10.1Print Format.....	- 12 -
10.2 Diagram: Serial interface.....	- 13 -

1. INTRODUCTION



- ◆ The TVD series weighing scales are suitable for general weighing, check weighing, simple parts counting, percent weighing, accumulation and units conversion.
- ◆ Capacities from 3kg to 30kg (6lb to 60lb).
- ◆ Rechargeable battery provide up to 70 hours of continues use (with out backlight).
- ◆ Large 24mm LCD with white LED back light display.
- ◆ 7 embossed membrane keys.

2. KEYS DESCRIPTION

Keys	Function	Function in menu
	Zero key <ul style="list-style-type: none"> ▪ Returns the display to zero 	Confirm key <ul style="list-style-type: none"> ▪ To enter selected sub-menu in settings
	Tare key <ul style="list-style-type: none"> ▪ Used to perform a tare function, Subtracts weights Value increment key <ul style="list-style-type: none"> ▪ Used to change the selected digit value 	Scroll up key <ul style="list-style-type: none"> ▪ To change sub-menu in parameter settings
	Limit key <ul style="list-style-type: none"> ▪ Set the limits for tolerance checking 	Right arrow key <ul style="list-style-type: none"> ▪ Used to move the digit to the right ▪ Scroll up menu in parameter settings
	Percent key <ul style="list-style-type: none"> ▪ Enters the percent weighing function ▪ To show weight, unit weight and counts when counting parts 	Left arrow key <ul style="list-style-type: none"> ▪ Used to move the digit to the left ▪ Scroll down menu in parameter settings
	Sampling key <ul style="list-style-type: none"> ▪ To switch from parts weighing to parts counting 	Clear key <ul style="list-style-type: none"> ▪ Used to reset parameters or clear the total accumulated values Escape key <ul style="list-style-type: none"> ▪ To return to normal weighing mode in other operating mode or in parameter settings
	Print key <ul style="list-style-type: none"> ▪ Used to send data to PC or printer Accumulation key <ul style="list-style-type: none"> ▪ To add the value to the accumulation memory, if the accumulation function is not automatic Memory recall key <ul style="list-style-type: none"> ▪ To show the stored values from the 	N.A

	memory	
	Units key ▪ Used to select weighing units (kg/g/lb/oz)	N.A

3. DISPLAY SYMBOLS

Symbols	Description
	Battery indicator. When it's illuminated, battery should be recharge
	Indicate when the load above (HI), load below (LO) and with in the limits (OK) in check weighing mode.
Gross	Gross Weight
Net	Net Weight
O	Stable indicator. When it's illuminated, the scale is stable
zero	Zero indicator. When it's illuminated, the scale is in Zero point
kg	Kilogram Mode
lb	Pound Mode
LED	Battery charging indicator

4. POWER CONNECTION

- Connect the adaptor pin in to the indicator adaptor jack. Adaptor jack is locating below the right side of the scale.
- Adaptor connects into your AC power socket. Plugable equipment must be installed near an easily accessible socket outlet with a protective ground/ earth contact.

4.1 Rechargeable battery operation

Note: Please charge the battery before using the scale for the first time.

- The symbol  on the weight display indicates that the battery is getting low. It means that it's time to charge the battery with the AC power. If scale goes on being used without proper charging, <BAT-LO> words will be displayed and the display will be flashed frequently.
- Approximately 1 hours of instrument usage are left; afterwards it will shut off automatically.
- Please use the supplied battery charger for charging the battery immediately, or scale cannot be used.

4.2 Charging the battery

- Before the first use, the battery should be charged by connecting it to the mains power supply for at least 12 hours.
- When the scale is plugged into the mains power the internal battery will be recharged.
- Verify that the AC power socket outlet is properly protected.
- Right side of the display there is an LED to indicate the status of battery charging. When the scale is plugged into the mains power the internal battery will be recharged.
- If the LED is green, the battery has a full charge.
- If it is red, the battery is being charged

5. BASIC OPERATION

5.1 Power On/Off

Power switch is located below the right side of the scale.

- 1 Turn the scale ON; press the switch forward and hold. The scale will show the capacity and enter a self-test mode and follow to enter the weighing mode.
- 2 Turn the scale OFF, press the switch forward once again.



5.2 Zero

Environmental conditions can lead to the balance exactly zero in spite of the platform not taking any strain. However, you can set the display of your balance to zero any time by

pressing  key and therefore ensure that the weighing starts at zero.





5.3 Tare

The weight of any container can be tared by pressing  button so that with subsequent weighing the net weight of the object being weighed is always displayed.

- 1 Load weight on the platform.
- 2 Press  key. Zero is displayed, and tare is subtracted.
- 3 Remove weight on the platform. Tared weight is displayed. It can set only one tare value. It will be shown with a minus value.
- 4 To clear the tare value, remove the load and press  key. Zero is displayed, tare weight is cleared.

5.4 Select Weighing Units

Press  key. It can select to kg/g/lb/oz in the weighing mode.

	Unit mark	Unit name	Conversion (g)
1		gram	
2		kilogram	= 1000g
3		lb	= 453.59237g
4		ounce	= 28.349523125g

5.5 Percent Weighing

The scale can set a sample weight to be shown as 100%. Then any other weights placed on the scale, it will be displayed as a percentage of the original sample.

Operation:





- 1 350g weight placed on the scale and followed by pressing the  key is pressed the display will show 100.00%.
- 2 Remove the weight, and ensure display is zero

- 3 Place 300g weight on the platform, display will be show 85.71 % as per the percentage of 350g (100%)
- 4 Press  key to return the scale to weighing mode.
 - The weighing may be amended on the basis of greater numbers of samples, improves the accuracy of percentage large quantities.

5.6 Parts Counting

In the weighing mode, it can enable scale to enter parts counting mode.

Operation:



- 1 Place the parts (pieces) items on the pan, items must be placed according to parts options.
- 2 Press the  key . Display shows P 10
- 3 It can select the parts options by pressing  key .
- 4 Parts options are P 10 / P 20 / P 50 / P 100 / P 200
- 5 Press  key when the displayed number matches the number of items used in the sample.
- 6 Scale will store the pieces according to the items.
- 7 It can add more pieces on the pan, display will be show the pieces according to the stored items.
- 8 Press  key to display unit weight (g / pcs) , Total weight (kg) and quantity (pcs).
- 9 Press  key to return the scale to weighing mode.









5.7 Tolerance checking

The weighing scales allow weighing items according to a target quantity or target weight or target percentage within specified tolerances. With this function one can also check if the weighing good is within a defined tolerance range. Reaching target quantity is indicated by an audio sound (if enabled in menu)













Note: Check weighing or counting available only when weight more than 20d

5.7.1 Limits setting for target weight













- 1 Press  key to set the check weighing function in weighing mode.
- 2 Display will be show the indicator  to set Hi-Limit and the first digit will be active. 000.000 kg

- 3 Use  and  keys to shift location and press  key to change the limit value, and press  key to confirm.
- 4 Scale will be confirmed the Hi-Limit and display will be show the indicator  to set Lo-Limit and the first digit will be active. 000.000 kg
- 5 Use  and  keys to shift location and press  key to change the limit value, and press  key to confirm.
- 6 Limits setting completed and display will return to zero, Load the weight on platter, the check weighing control will start .

5.7.2 Limits setting for target quantity

- 1 Place the parts (pieces) items on the pan.
- 2 Press  key to display P 10 option.
- 3 Press  key to confirm and display will be come to counting mode.
- 4 Press  key to set the check counting function.
- 5 Display will be show the indicator  to set Hi-Limit and the first digit will be active. 000000 pcs
- 6 Use  and  keys to shift location and press  key to change the limit value, and press  key to confirm.
- 7 Scale will be confirmed the Hi-Limit and display will be show the indicator  to set Lo-Limit and the first digit will be active. 000000 pcs.
- 8 Use  and  keys to shift location and press  key to change the limit value, and press  key to confirm.
- 9 Limits setting completed and display will return to zero, Load the weight on platter, the check counting control will start .

5.7.3 Limits setting for target percentage



- 1 Place the items on the pan.
- 2 Press  key ,it will display 100%
- 3 Remove the items,scale will be come to percentage mode.
- 4 Press  key to set the check counting function.
- 5 Display will be show the indicator  to set Hi-Limit and the first digit will be active. 0000.00 %
- 6 Use  and  keys to shift location and press  key to change the limit value, and press  key to confirm.
- 7 Scale will be confirmed the Hi-Limit and display will be show the indicator  to set Lo-Limit and the first digit will be active. 0000.00 %.
- 8 Use  and  keys to shift location and press  key to change the limit value, and press  key to confirm.
- 9 Limits setting completed and display will return to zero,Load the weight on platter,the check percentage control will start .

5.7.4 To set beep mode



The beep sound depends on the settings made in menu block

Options:

beep 0	Beep sound turned off
beep 1	Beep sound will ring out when load is within tolerance range
beep 2	Beep sound will ring out when load is beyond tolerance range

	When target quantity/target weight/target percentage is exceeds maximum tolerance limit
	When target quantity/target weight/target percentage is within tolerance range
	When target quantity/target weight/target percentage is below minimum tolerance limit

5.7.5 To disable check weighing mode

- 1 Press the  key to display current limits.
- 2 Press the  key to enter zero into both limits when the current limits are shown,
- 3 Press the  key to store the zero values.

Notes

- **Check weighing available only when weight more than 20d**
- **The function is not valid when one enters a lower limit greater than the upper limit.**
- **When lower limits are the same with upper limits, display only shows one set value.**

5.8 Accumulation

TVD can set to accumulate manually by pressing  key or automatically. Before operation scale should be stable and return to zero, accumulation available only when weight more than 20d

To set the accumulation function to turn on, select the parameter ACC>ON

Note: Accumulation function can operate only in weighing mode.

5.8.1 Manual Accumulation

In the normal weighing mode, ensure display is zero and stable indicator is on.



- 1 Place the items on the platform and press  key, when the display get stable
- 2 Display will be show ACC 1 and will show the total of the accumulation
- 3 The data will be sent to printer or PC if connected with printer or computer
- 4 Remove the weight from the pan for to get display zero and stable for the next accumulation.
- 5 Scale should be get stable and zero for the next accumulation.

It can continue 99 operations or until to reach the maximum value of display.

5.8.2 Recall Memory

Press  key, when the display in the normal weighing mode, display will be show the accumulation times and will show the total values. These display will be show only two seconds.

5.8.3 Memory Clear

To clear the memory, press  key to view and press  key during the accumulation displayed. Display will be show normal display , all accumulation memory cleared from the memory

5.8.4 Automatic Accumulation

To enable the automatic accumulation, please see parameter AU>ON
Scale will be do the accumulation automatically.

- 1 Place the items on the platform.
- 2 After stable, buzzer will be beep once.
- 3 Remove the weight from the pan .
- 4 Display will be show the accumulation times and total value, these display will be show only two seconds.
- 5 Display should be come to zero and stable for the next operation.





5.9 Printing

The weighing data can be printed out by pressing  keys when connected with printer.
To enable the printing function, please as per the following settings.

See detail parameters:

- 1.B9600
- 2.ACC ON
- 3.LP-50

5.10 Back Light Setting

- 1 Press  and  keys during that start up.
- 2 Press  key until display show *EL AU*
- 3 Press  key to select the sub menu options.
- 4 Press  key to confirm.

<i>EL AU</i>	To set auto option. When start to use back light will be on and when stop the operation back light also will off.
<i>EL on</i>	To set always on. After turn on the power, back light also will be on.
<i>EL off</i>	To set back light turn off. No back light in the operations

5.11 Power Auto Off

After scale operations, when scale is not in use, it can set to turn off automatically

- 1 Press **ACC/TTL PRINT** and **PCS** keys during that start up.
- 2 Press **LIMIT** key until display show **aF 0**
- 3 Press **TARE** key to select the sub menu options.
- 4 Press **ZERO** key to confirm.

aF 0	Set to turn off the auto off function
aF 3	Set to turn off three minutes later with no weight changes or key presses.
aF 5	Set to turn off five minutes later with no weight changes or key presses.
aF 15	Set to turn off 15 minutes later with no weight changes or key presses.
aF 30	Set to turn off 30 later with no weight changes or key presses.

5.12 Check Internal Counts

- 1 Turn on the scale and press **ZERO** and **% U.W** keys during the self test. Display will be show internal counts.
- 2 Press **PCS** key to return the scale to weighing mode.

6. SPECIFICATION

MODEL	TVD-6	TVD-12	TVD-30	TVD-60
Capacity	6 lb 96 oz 3000 g 3 kg	12 lb 192 oz 6000 g 6 kg	30 lb 480 oz 15000 g 15 kg	60 lb 960 oz 30000 g 30 kg
Readability	0.001 lb 0.02 oz 0.5 g 0.0005 kg	0.002 lb 0.05 oz 1 g 0.001 kg	0.005 lb 0.1 oz 2 g 0.002 kg	0.01 lb 0.2 oz 5 g 0.005 kg
Resolution	1/6000			
Weighing Units	kg/g/lb/oz			
Display	6 digits 0.94inch /24mm digits LCD Display with white LED back Light			
Platter size	9.1 x 11.8 inch / 230 x 300mm			
Housing	ABS plastic housing; stainless steel platter			
Operation Temperature	14°F - 104°F / -10°C - + 40°C			
Power	Input AC 100-240V, output DC 12V/500mA 6V/4Ah rechargeable battery			
Battery life	Approx. 58 hours with backlight of continuous use Approx. 70 hours without backlight of continuous use			
Keypad	7 membrane keys			
Dimensions (inch/mm)	12.4 (W) x 13.8 (D) x 4.7 (H) / 315 (W) x 349.9 (D) x 118.5 (H)			
Net weight	9.9 lb (4.5 kg)			
Gross weight	11.2 lb (5.1 kg)			

7. DIMMENSIONS(inch/mm)

TVD

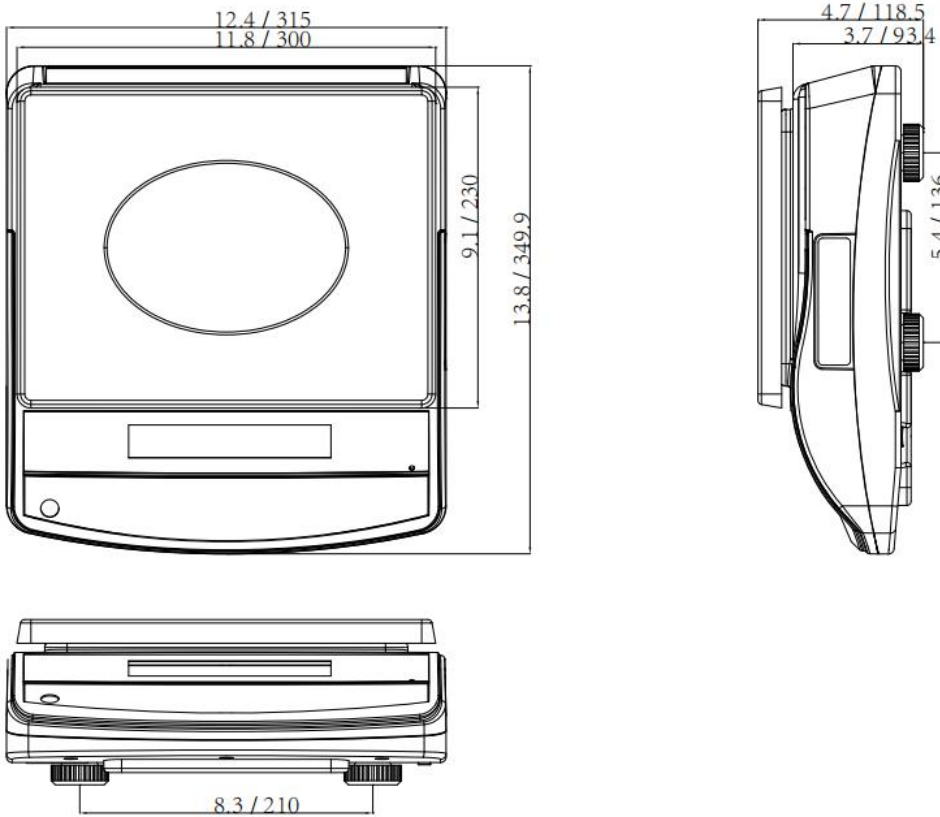



8.ERROR MESSAGE

Error Message	Description	Solution
-----	Underload	Minus weight, check the platform and restart or calibrate.
<i>Err 4</i>	Zero setting error	Zero setting range exceeded due to switching on. Make sure platform empty.
<i>Err 6</i>	A/D value out of range	Make sure platform empty and check the pan is installed proper. Check the load cell
<i>Err 7</i>	Percentage Error	Please check input data, must be > 0.5d
<i>Err 19</i>	Initialize zero error	Calibration the scale.
--oL--	Over range	Remove the load. Re-calibrate
<i>FA , L</i>	Calibration Error	Re-calibrate
<i>bAt Lo</i>	Battery low	Recharge battery, check the voltages.

9.SELECTING THE PRINTER

For printer setting, it needs to enter the parameters settings to select LP50, use  key to select options.

	Options	Description
LP50	LAB 0	Press  key to send data to DLP-50 label printer
	RFT 1	Press  key to send data to DEP-50 receipt printer
	RFT 2	Press  key to send data to DEP-50- receipt printer

10.RS232 OUT PUT

The TVD Series of scales can be ordered with a standard RS-232 output. It can be connected to DEP-50 receipt printer & DLP-50 label printer

10.1Print Format

THANK YOU

Weight: 1.745 lb

FEB.23.2021 17:50:36

Gross : 0.500 lb
Tare : 0.000 lb
Net : 0.500 lb

Gross : 0.106 lb
Tare : 0.000 lb
Net : 0.106 lb

Gross : 0.606 lb
Tare : 0.106 lb
Net : 0.500 lb

TOTAL : 1.106 lb

1 1.100 lb
2 1.100 lb
3 1.105 lb
4 1.100 lb
5 1.100 lb
6 1.100 lb

TOTAL : 6.605 lb
COUNT : 6

Label Format

Receipt Format # 1

Receipt Format # 2

10.2 Diagram: Serial interface

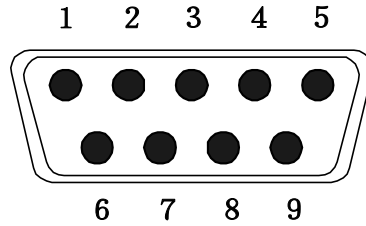

Pin 2	RXD	Input	Receiving data
Pin 3	TXD	Output	Transmission data
Pin 5	GND	—	Signal ground

9pin D Connector:

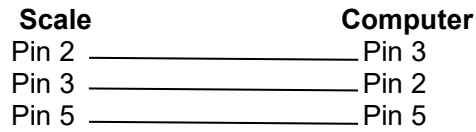

Note: if data not getting in Printer, want to inter-change the pin 1 and pin2 connections

VISIONTECH
SHOP www.VisionTechShop.com





100 Temple Ave. Hackensack, NJ 07601

Tel:+ 1-201-679-7793





TVD Calibration Manual

- 1 Turn on the scale

Before entering the parameter, it is required to press continuously the calibration switch, the switch is located below the scale or it should be short the Jump Pin K4 in the PCB (See the photo below).

- 2 Press the  and  keys together during the self-test starting when you see the numbers 9 to 0 on the display.
- 3 The display will then show “CAL kg”.
- 4 Press the  key to change the unit to “lb”
- 5 Press the  key to confirm the “lb” change.
- 6 The display will then show “unload”.
- 7 Remove all weights from the platform.
- 8 Press the  key.

The display will be shown a calibration weight point. When the display is not 000.000, press  key to clear. Depending on the device you are using; for example the AHW-6lb is maximum allowed is 6lb so you would change the weight to 006.000 using the

- 9 Press the ,  and  keys to select and modify the desired calibration weight.
- 9 Press the  key, then the display will show “Load ”.
- 10 Place the desired calibration test weight on the platform.
- 11 Press the  key when it shows the stable indicator, then the display will show “pass ”.
- 12 The scale will then be restarted and will be ready for normal operation, then during the self-test remove test weights from the platform.
- 13 Utilize the jump pins as highlighted and correlate them with the following set scale capacities

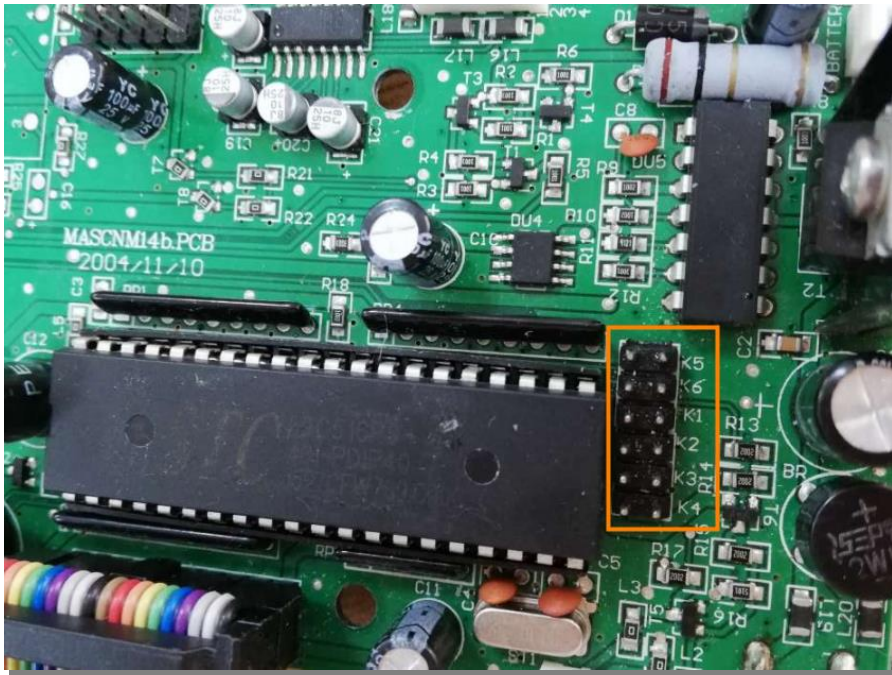

TVD Series	
6lbs/3kg	Short K6 and K1
12lbs/6kg	Short K6
30lbs/12kg	Short K1
60lbs/30kg	No short

